

# TOWARDS M-MATRIX

Matti Pitkänen

*Köydenpunojankatu D 11, 10900, Hanko, Finland*



## Preface

This book belongs to a series of online books summarizing the recent state Topological Geometro-dynamics (TGD) and its applications. TGD can be regarded as a unified theory of fundamental interactions but is not the kind of unified theory as so called GUTs constructed by graduate students at seventies and eighties using detailed recipes for how to reduce everything to group theory. Nowadays this activity has been completely computerized and it probably takes only a few hours to print out the predictions of this kind of unified theory as an article in the desired format. TGD is something different and I am not ashamed to confess that I have devoted the last 32 years of my life to this enterprise and am still unable to write The Rules.

I got the basic idea of Topological Geometro-dynamics (TGD) during autumn 1978, perhaps it was October. What I realized was that the representability of physical space-times as 4-dimensional surfaces of some higher-dimensional space-time obtained by replacing the points of Minkowski space with some very small compact internal space could resolve the conceptual difficulties of general relativity related to the definition of the notion of energy. This belief was too optimistic and only with the advent of what I call zero energy ontology the understanding of the notion of Poincare invariance has become satisfactory.

It soon became clear that the approach leads to a generalization of the notion of space-time with particles being represented by space-time surfaces with finite size so that TGD could be also seen as a generalization of the string model. Much later it became clear that this generalization is consistent with conformal invariance only if space-time is 4-dimensional and the Minkowski space factor of imbedding space is 4-dimensional.

It took some time to discover that also the geometrization of also gauge interactions and elementary particle quantum numbers could be possible in this framework: it took two years to find the unique internal space providing this geometrization involving also the realization that family replication phenomenon for fermions has a natural topological explanation in TGD framework and that the symmetries of the standard model symmetries are much more profound than pragmatic TOE builders have believed them to be. If TGD is correct, main stream particle physics chose the wrong track leading to the recent deep crisis when people decided that quarks and leptons belong to same multiplet of the gauge group implying instability of proton.

There have been also longstanding problems.

- Gravitational energy is well-defined in cosmological models but is not conserved. Hence the conservation of the inertial energy does not seem to be consistent with the Equivalence Principle. Furthermore, the imbeddings of Robertson-Walker cosmologies turned out to be vacuum extremals with respect to the inertial energy. About 25 years was needed to realize that the sign of the inertial energy can be also negative and in cosmological scales the density of inertial energy vanishes: physically acceptable universes are creatable from vacuum. Eventually this led to the notion of zero energy ontology which deviates dramatically from the standard ontology being however consistent with the crossing symmetry of quantum field theories. In this framework the quantum numbers are assigned with zero energy states located at the boundaries of so called causal diamonds defined as intersections of future and past directed light-cones. The notion of energy-momentum becomes length scale dependent since one has a scale hierarchy for causal diamonds. This allows to understand the non-conservation of energy as apparent. Equivalence Principle generalizes and has a formulation in terms of coset representations of Super-Virasoro algebras providing also a justification for p-adic thermodynamics.
- From the beginning it was clear that the theory predicts the presence of long ranged classical electro-weak and color gauge fields and that these fields necessarily accompany classical electromagnetic fields. It took about 26 years to gain the maturity to admit the obvious: these fields are classical correlates for long range color and weak interactions assignable to dark matter. The only possible conclusion is that TGD physics is a fractal consisting of an entire hierarchy of fractal copies of standard model physics. Also the understanding of electro-weak massivation and screening of weak charges has been a long standing problem, and 32 years was needed to discover that what I call weak form of electric-magnetic duality gives a satisfactory solution of the problem and provides also surprisingly powerful insights to the mathematical structure of quantum TGD.

I started the serious attempts to construct quantum TGD after my thesis around 1982. The original optimistic hope was that path integral formalism or canonical quantization might be enough to construct the quantum theory but the first discovery made already during first year of TGD was that these formalisms might be useless due to the extreme non-linearity and enormous vacuum degeneracy of the theory. This turned out to be the case.

- It took some years to discover that the only working approach is based on the generalization of Einstein's program. Quantum physics involves the geometrization of the infinite-dimensional "world of classical worlds" (WCW) identified as 3-dimensional surfaces. Still few years had to pass before I understood that general coordinate invariance leads to a more or less unique solution of the problem and implies that space-time surfaces are analogous to Bohr orbits. Still a couple of years and I discovered that quantum states of the Universe can be identified as classical spinor fields in WCW. Only quantum jump remains the genuinely quantal aspect of quantum physics.
- During these years TGD led to a rather profound generalization of the space-time concept. Quite general properties of the theory led to the notion of many-sheeted space-time with sheets representing physical subsystems of various sizes. At the beginning of 90s I became dimly aware of the importance of p-adic number fields and soon ended up with the idea that p-adic thermodynamics for a conformally invariant system allows to understand elementary particle massivation with amazingly few input assumptions. The attempts to understand p-adicity from basic principles led gradually to the vision about physics as a generalized number theory as an approach complementary to the physics as an infinite-dimensional spinor geometry of WCW approach. One of its elements was a generalization of the number concept obtained by fusing real numbers and various p-adic numbers along common rationals. The number theoretical trinity involves besides p-adic number fields also quaternions and octonions and the notion of infinite prime.
- TGD inspired theory of consciousness entered the scheme after 1995 as I started to write a book about consciousness. Gradually it became difficult to say where physics ends and consciousness theory begins since consciousness theory could be seen as a generalization of quantum measurement theory by identifying quantum jump as a moment of consciousness and by replacing the observer with the notion of self identified as a system which is conscious as long as it can avoid entanglement with environment. "Everything is conscious and consciousness can be only lost" summarizes the basic philosophy neatly. The idea about p-adic physics as physics of cognition and intentionality emerged also rather naturally and implies perhaps the most dramatic generalization of the space-time concept in which most points of p-adic space-time sheets are infinite in real sense and the projection to the real imbedding space consists of discrete set of points. One of the most fascinating outcomes was the observation that the entropy based on p-adic norm can be negative. This observation led to the vision that life can be regarded as something in the intersection of real and p-adic worlds. Negentropic entanglement has interpretation as a correlate for various positively colored aspects of conscious experience and means also the possibility of strongly correlated states stable under state function reduction and different from the conventional bound states and perhaps playing key role in the energy metabolism of living matter.
- One of the latest threads in the evolution of ideas is only slightly more than six years old. Learning about the paper of Laurent Nottale about the possibility to identify planetary orbits as Bohr orbits with a gigantic value of gravitational Planck constant made once again possible to see the obvious. Dynamical quantized Planck constant is strongly suggested by quantum classical correspondence and the fact that space-time sheets identifiable as quantum coherence regions can have arbitrarily large sizes. During summer 2010 several new insights about the mathematical structure and interpretation of TGD emerged. One of these insights was the realization that the postulated hierarchy of Planck constants might follow from the basic structure of quantum TGD. The point is that due to the extreme non-linearity of the classical action principle the correspondence between canonical momentum densities and time derivatives of the imbedding space coordinates is one-to-many and the natural description of the situation is in terms of local singular covering spaces of the imbedding space. One could speak about effective value of Planck

constant coming as a multiple of its minimal value. The implications of the hierarchy of Planck constants are extremely far reaching so that the significance of the reduction of this hierarchy to the basic mathematical structure distinguishing between TGD and competing theories cannot be under-estimated.

From the point of view of particle physics the ultimate goal is of course a practical construction recipe for the S-matrix of the theory. I have myself regarded this dream as quite too ambitious taking into account how far reaching re-structuring and generalization of the basic mathematical structure of quantum physics is required. It has indeed turned out that the dream about explicit formula is unrealistic before one has understood what happens in quantum jump. Symmetries and general physical principles have turned out to be the proper guide line here. To give some impressions about what is required some highlights are in order.

- With the emergence of zero energy ontology the notion of S-matrix was replaced with M-matrix which can be interpreted as a complex square root of density matrix representable as a diagonal and positive square root of density matrix and unitary S-matrix so that quantum theory in zero energy ontology can be said to define a square root of thermodynamics at least formally.
- A decisive step was the strengthening of the General Coordinate Invariance to the requirement that the formulations of the theory in terms of light-like 3-surfaces identified as 3-surfaces at which the induced metric of space-time surfaces changes its signature and in terms of space-like 3-surfaces are equivalent. This means effective 2-dimensionality in the sense that partonic 2-surfaces defined as intersections of these two kinds of surfaces plus 4-D tangent space data at partonic 2-surfaces code for the physics. Quantum classical correspondence requires the coding of the quantum numbers characterizing quantum states assigned to the partonic 2-surfaces to the geometry of space-time surface. This is achieved by adding to the modified Dirac action a measurement interaction term assigned with light-like 3-surfaces.
- The replacement of strings with light-like 3-surfaces equivalent to space-like 3-surfaces means enormous generalization of the super conformal symmetries of string models. A further generalization of these symmetries to non-local Yangian symmetries generalizing the recently discovered Yangian symmetry of  $\mathcal{N} = 4$  supersymmetric Yang-Mills theories is highly suggestive. Here the replacement of point like particles with partonic 2-surfaces means the replacement of conformal symmetry of Minkowski space with infinite-dimensional super-conformal algebras. Yangian symmetry provides also a further refinement to the notion of conserved quantum numbers allowing to define them for bound states using non-local energy conserved currents.
- A further attractive idea is that quantum TGD reduces to almost topological quantum field theory. This is possible if the Kähler action for the preferred extremals defining WCW Kähler function reduces to a 3-D boundary term. This takes place if the conserved currents are so called Beltrami fields with the defining property that the coordinates associated with flow lines extend to single global coordinate variable. This ansatz together with the weak form of electric-magnetic duality reduces the Kähler action to Chern-Simons term with the condition that the 3-surfaces are extremals of Chern-Simons action subject to the constraint force defined by the weak form of electric magnetic duality. It is the latter constraint which prevents the trivialization of the theory to a topological quantum field theory. Also the identification of the Kähler function of WCW as Dirac determinant finds support as well as the description of the scattering amplitudes in terms of braids with interpretation in terms of finite measurement resolution coded to the basic structure of the solutions of field equations.
- In standard QFT Feynman diagrams provide the description of scattering amplitudes. The beauty of Feynman diagrams is that they realize unitarity automatically via the so called Cutkosky rules. In contrast to Feynman's original beliefs, Feynman diagrams and virtual particles are taken only as a convenient mathematical tool in quantum field theories. QFT approach is however plagued by UV and IR divergences and one must keep mind open for the possibility that a genuine progress might mean opening of the black box of the virtual particle.

In TGD framework this generalization of Feynman diagrams indeed emerges unavoidably. Light-like 3-surfaces replace the lines of Feynman diagrams and vertices are replaced by 2-D partonic

2-surfaces. Zero energy ontology and the interpretation of parton orbits as light-like "wormhole throats" suggests that virtual particles do not differ from mass shell particles only in that the four- and three- momenta of wormhole throats fail to be parallel. The two throats of the wormhole defining virtual particle would contact carry on mass shell quantum numbers but for virtual particles the four-momenta need not be parallel and can also have opposite signs of energy. Modified Dirac equation suggests a number theoretical quantization of the masses of the virtual particles. The kinematic constraints on the virtual momenta are extremely restrictive and reduce the dimension of the sub-space of virtual momenta and if massless particles are not allowed (IR cutoff provided by zero energy ontology naturally), the number of Feynman diagrams contributing to a particular kind of scattering amplitude is finite and manifestly UV and IR finite and satisfies unitarity constraint in terms of Cutkosky rules. What is remarkable that fermionic propagators are massless propagators but for on mass shell four-momenta. This gives a connection with the twistor approach and inspires the generalization of the Yangian symmetry to infinite-dimensional super-conformal algebras.

What I have said above is strongly biased view about the recent situation in quantum TGD and I have left all about applications to the introductions of the books whose purpose is to provide a bird's eye view about TGD as it is now. This vision is single man's view and doomed to contain unrealistic elements as I know from experience. My dream is that young critical readers could take this vision seriously enough to try to demonstrate that some of its basic premises are wrong or to develop an alternative based on these or better premises. I must be however honest and tell that 32 years of TGD is a really vast bundle of thoughts and quite a challenge for anyone who is not able to cheat himself by taking the attitude of a blind believer or a light-hearted debunker trusting on the power of easy rhetoric tricks.

Matti Pitkänen

Hanko,

September 15, 2010

## Acknowledgements

Neither TGD nor these books would exist without the help and encouragement of many people. The friendship with Heikki and Raija Haila and their family have kept me in contact with the everyday world and without this friendship I would not have survived through these lonely 32 years most of which I have remained unemployed as a scientific dissident. I am happy that my children have understood my difficult position and like my friends have believed that what I am doing is something valuable although I have not received any official recognition for it.

During last decade Tapio Tammi has helped me quite concretely by providing the necessary computer facilities and being one of the few persons in Finland with whom to discuss about my work. I have had also stimulating discussions with Samuli Penttinen who has also helped to get through the economical situations in which there seemed to be no hope. The continual updating of fifteen online books means quite a heavy bureaucracy at the level of bits and without a systemization one ends up with endless copying and pasting and internal consistency is soon lost. Pekka Rapinoja has offered his help in this respect and I am especially grateful for him for my Python skills. Also Matti Vallinkoski has helped me in computer related problems.

The collaboration with Lian Sidorov was extremely fruitful and she also helped me to survive economically through the hardest years. The participation to CASYS conferences in Liege has been an important window to the academic world and I am grateful for Daniel Dubois and Peter Marcer for making this participation possible. The discussions and collaboration with Eduardo de Luna and Istvan Dienes stimulated the hope that the communication of new vision might not be a mission impossible after all. Also blog discussions have been very useful. During these years I have received innumerable email contacts from people around the world. In particular, I am grateful for Mark McWilliams and Ulla Matfolk for providing links to possibly interesting web sites and articles. These contacts have helped me to avoid the depressive feeling of being some kind of Don Quixote of Science and helped me to widen my views: I am grateful for all these people.

In the situation in which the conventional scientific communication channels are strictly closed it is important to have some loop hole through which the information about the work done can at

least in principle leak to the publicity through the iron wall of the academic censorship. Without any exaggeration I can say that without the world wide web I would not have survived as a scientist nor as individual. Homepage and blog are however not enough since only the formally published result is a result in recent day science. Publishing is however impossible without a direct support from power holders- even in archives like arXiv.org.

Situation changed for five years ago as Andrew Adamatsky proposed the writing of a book about TGD when I had already got used to the thought that my work would not be published during my life time. The Prespacetime Journal and two other journals related to quantum biology and consciousness - all of them founded by Huping Hu - have provided this kind of loop holes. In particular, Dainis Zeps, Phil Gibbs, and Arkadiusz Jadczyk deserve my gratitude for their kind help in the preparation of an article series about TGD catalyzing a considerable progress in the understanding of quantum TGD. Also the viXra archive founded by Phil Gibbs and its predecessor Archive Freedom have been of great help: Victor Christianto deserves special thanks for doing the hard work needed to run Archive Freedom. Also the Neuroquantology Journal founded by Sultan Tarlaci deserves a special mention for its publication policy. And last but not least: there are people who experience as a fascinating intellectual challenge to spoil the practical working conditions of a person working with something which might be called unified theory: I am grateful for the people who have helped me to survive through the virus attacks, an activity which has taken roughly one month per year during the last half decade and given a strong hue of grey to my hair.

For a person approaching his sixty year birthday it is somewhat easier to overcome the hard feelings due to the loss of academic human rights than for an inpatient youngster. Unfortunately the economic situation has become increasingly difficult during the twenty years after the economic depression in Finland which in practice meant that Finland ceased to be a constitutional state in the strong sense of the word. It became possible to depose people like me from the society without fear about public reactions and the classification as dropout became a convenient tool of ridicule to circumvent the ethical issues. During last few years when the right wing has held the political power this trend has been steadily strengthening. In this kind of situation the concrete help from individuals has been and will be of utmost importance. Against this background it becomes obvious that this kind of work is not possible without the support from outside and I apologize for not being able to mention all the people who have helped me during these years.

Matti Pitkänen

Hanko,

September 15, 2010





# Contents

<b>1</b>	<b>Introduction</b>	<b>1</b>
1.1	Basic Ideas of TGD	1
1.1.1	Background	1
1.1.2	TGD as a Poincare invariant theory of gravitation	2
1.1.3	TGD as a generalization of the hadronic string model	2
1.1.4	Fusion of the two approaches via a generalization of the space-time concept	2
1.2	The threads in the development of quantum TGD	3
1.2.1	Quantum TGD as spinor geometry of World of Classical Worlds	3
1.2.2	TGD as a generalized number theory	5
1.2.3	Hierarchy of Planck constants and dark matter hierarchy	8
1.2.4	TGD as a generalization of physics to a theory consciousness	10
1.3	Bird's eye of view about the topics of the book	15
1.4	The contents of the book	18
1.4.1	Part I: The recent view about field equations	18
1.4.2	Part II: General Theory	20
1.4.3	Part III: Twistors, Bosonic Emergence, Space-time Supersymmetry	27
1.4.4	Part IV: Hyper-Finite Factors of Type II and Hierarchy of Planck Constants	31
<b>I</b>	<b>THE RECENT VIEW ABOUT FIELD EQUATIONS</b>	<b>47</b>
<b>2</b>	<b>Basic Extremals of the Kähler Action</b>	<b>49</b>
2.1	Introduction	49
2.1.1	General considerations	49
2.1.2	In what sense field equations mimic dissipative dynamics?	50
2.1.3	The dimension of $CP_2$ projection as classifier for the fundamental phases of matter	50
2.1.4	Specific extremals of Kähler action	51
2.1.5	The weak form of electric-magnetic duality and modification of Kähler action	51
2.2	General considerations	52
2.2.1	Number theoretical compactification and $M^8 - H$ duality	52
2.2.2	The exponent of Kähler function as Dirac determinant for the modified Dirac action	54
2.2.3	Preferred extremal property as classical correlate for quantum criticality, holography, and quantum classical correspondence	55
2.2.4	Can one determine experimentally the shape of the space-time surface?	57
2.3	General view about field equations	59
2.3.1	Field equations	59
2.3.2	Topologization and light-likeness of the Kähler current as alternative manners to guarantee vanishing of Lorentz 4-force	60
2.3.3	How to satisfy field equations?	65
2.3.4	$D_{CP_2} = 3$ phase allows infinite number of topological charges characterizing the linking of magnetic field lines	75
2.3.5	Preferred extremal property and the topologization/light-likeness of Kähler current?	76
2.3.6	Generalized Beltrami fields and biological systems	77

2.3.7	About small perturbations of field equations . . . . .	81
2.4	Vacuum extremals . . . . .	84
2.4.1	$CP_2$ type extremals . . . . .	84
2.4.2	Vacuum extremals with vanishing Kähler field . . . . .	88
2.5	Non-vacuum extremals . . . . .	89
2.5.1	Cosmic strings . . . . .	89
2.5.2	Massless extremals . . . . .	89
2.5.3	Generalization of the solution ansatz defining massless extremals (MEs) . . . . .	90
2.5.4	Maxwell phase . . . . .	94
2.5.5	Stationary, spherically symmetric extremals . . . . .	95
2.5.6	Maxwell hydrodynamics as a toy model for TGD . . . . .	102
2.6	Weak form electric-magnetic duality and its implications . . . . .	105
2.6.1	Could a weak form of electric-magnetic duality hold true? . . . . .	107
2.6.2	Magnetic confinement, the short range of weak forces, and color confinement . . . . .	111
2.6.3	Could Quantum TGD reduce to almost topological QFT? . . . . .	114
2.6.4	Kähler action for Euclidian regions as Kähler function and Kähler action for Minkowskian regions as Morse function? . . . . .	116
2.6.5	A general solution ansatz based on almost topological QFT property . . . . .	118
2.6.6	Hydrodynamic picture in fermionic sector . . . . .	121
2.6.7	Possible role of Beltrami flows and symplectic invariance in the description of gauge and gravitational interactions . . . . .	127
2.7	How to define Dirac determinant? . . . . .	129
2.7.1	Dirac determinant when the number of eigenvalues is infinite . . . . .	129
2.7.2	Hyper-octonionic primes . . . . .	131
2.7.3	Three basic options for the pseudo-momentum spectrum . . . . .	132
2.7.4	Expression for the Dirac determinant for various options . . . . .	134
2.8	An attempt to understand preferred extremals of Kähler action . . . . .	142
2.8.1	Basic ideas about preferred extremals . . . . .	143
2.8.2	What could be the construction recipe for the preferred extremals assuming $CP_2 = CP_2^{mod}$ identification? . . . . .	147
2.8.3	Could octonion analyticity solve the field equations? . . . . .	150
2.9	In what sense TGD could be an integrable theory? . . . . .	158
2.9.1	What integrable theories are? . . . . .	158
2.9.2	Why TGD could be integrable theory in some sense? . . . . .	161
2.9.3	Questions . . . . .	162
2.9.4	Could TGD be an integrable theory? . . . . .	162
2.10	About deformations of known extremals of Kähler action . . . . .	163
2.10.1	What might be the common features of the deformations of known extremals . . . . .	163
2.10.2	What small deformations of $CP_2$ type vacuum extremals could be? . . . . .	166
2.10.3	Hamilton-Jacobi conditions in Minkowskian signature . . . . .	169
2.10.4	Deformations of cosmic strings . . . . .	170
2.10.5	Deformations of vacuum extremals? . . . . .	171
2.10.6	About the interpretation of the generalized conformal algebras . . . . .	172
2.11	Do geometric invariants of preferred extremals define topological invariants of space-time surface and code for quantum physics? . . . . .	173
2.11.1	Preferred extremals of Kähler action as manifolds with constant Ricci scalar whose geometric invariants are topological invariants . . . . .	173
2.11.2	Is there a connection between preferred extremals and AdS <sub>4</sub> /CFT correspondence? . . . . .	174
2.11.3	Generalizing Ricci flow to Maxwell flow for 4-geometries and Kähler flow for space-time surfaces . . . . .	176
2.11.4	Could correlation functions, S-matrix, and coupling constant evolution be coded the statistical properties of preferred extremals? . . . . .	181
2.12	Does thermodynamics have a representation at the level of space-time geometry? . . . . .	184
2.12.1	Motivations and background . . . . .	184
2.12.2	Kiehn's topological thermodynamics (TTD) . . . . .	186
2.12.3	Attempt to identify TTD in TGD framework . . . . .	187

<b>3</b>	<b>The Recent Vision about Preferred Extremals and Solutions of the Modified Dirac Equation</b>	<b>205</b>
3.1	Introduction . . . . .	205
3.2	About deformations of known extremals of Kähler action . . . . .	206
3.2.1	What might be the common features of the deformations of known extremals . . . . .	206
3.2.2	What small deformations of $CP_2$ type vacuum extremals could be? . . . . .	209
3.2.3	Hamilton-Jacobi conditions in Minkowskian signature . . . . .	212
3.2.4	Deformations of cosmic strings . . . . .	213
3.2.5	Deformations of vacuum extremals? . . . . .	214
3.2.6	About the interpretation of the generalized conformal algebras . . . . .	215
3.3	Under what conditions electric charge is conserved for the modified Dirac equation? . . . . .	216
3.3.1	Conditions guaranteing the conservation of em charge . . . . .	216
3.3.2	Dirac equation in $CP_2$ as a test bench . . . . .	218
3.3.3	How to satisfy the conditions guaranteing the conservation of em charge? . . . . .	218
3.3.4	Could the solutions of the modified Dirac equation be restricted to 2-D surfaces? . . . . .	220
3.3.5	The algebra spanned by the modified Dirac operators . . . . .	221
3.3.6	Connection with the number theoretical vision about field equations . . . . .	222
3.3.7	Modification of the measurement interaction term . . . . .	225
3.4	Preferred extremals and solutions of the modified Dirac equation and super-conformal symmetries . . . . .	226
3.4.1	Super-conformal symmetries . . . . .	227
3.4.2	What is the role of the right-handed neutrino? . . . . .	228
3.4.3	WCW geometry and super-conformal symmetries . . . . .	231
3.4.4	Equivalence Principle . . . . .	233
3.4.5	Constraints from p-adic mass calculations and ZEO . . . . .	233
3.4.6	The emergence of Yangian symmetry and gauge potentials as duals of Kac-Moody currents . . . . .	235
3.4.7	Quantum criticality and electro-weak gauge symmetries . . . . .	237
3.4.8	The importance of being light-like . . . . .	240
3.4.9	Realization of large $\mathcal{N}$ SUSY in TGD . . . . .	241
3.5	Twistor revolution and TGD . . . . .	244
3.5.1	The origin of twistor diagrammatics . . . . .	244
3.5.2	The emergence of 2-D sub-dynamics at space-time level . . . . .	245
3.5.3	The emergence of Yangian symmetry . . . . .	246
3.5.4	The analog of $AdS^5$ duality in TGD framework . . . . .	246
3.5.5	Problems of the twistor approach from TGD point of view . . . . .	248
3.5.6	Could $\mathcal{N} = 2$ or $\mathcal{N} = 4$ SUSY be a part of TGD after all? . . . . .	249
3.6	$M^8 - H$ duality, preferred extremals, criticality, and Mandelbrot fractals . . . . .	254
3.6.1	$M^8 - H$ duality briefly . . . . .	254
3.6.2	The integrability conditions . . . . .	255
3.6.3	How to solve the integrability conditions and field equations for preferred extremals? . . . . .	256
3.6.4	Connection with Mandelbrot fractal and fractals as fixed sets for iteration . . . . .	257
3.7	Do geometric invariants of preferred extremals define topological invariants of space-time surface and code for quantum physics? . . . . .	258
3.7.1	Preferred extremals of Kähler action as manifolds with constant Ricci scalar whose geometric invariants are topological invariants . . . . .	259
3.7.2	Is there a connection between preferred extremals and $AdS_4/CFT$ correspondence? . . . . .	259
3.7.3	Generalizing Ricci flow to Maxwell flow for 4-geometries and Kähler flow for space-time surfaces . . . . .	261
3.7.4	Could correlation functions, S-matrix, and coupling constant evolution be coded the statistical properties of preferred extremals? . . . . .	266
3.8	Appendix: Hamilton-Jacobi structure . . . . .	268
3.8.1	Hermitian and hyper-Hermitian structures . . . . .	269
3.8.2	Hamilton-Jacobi structure . . . . .	269

<b>II</b>	<b>GENERAL THEORY</b>	<b>283</b>
<b>4</b>	<b>Construction of Quantum Theory: Symmetries</b>	<b>285</b>
4.1	Introduction . . . . .	285
4.1.1	Physics as infinite-dimensional Kähler geometry . . . . .	285
4.1.2	p-Adic physics as physics of cognition and intentionality . . . . .	286
4.1.3	Hierarchy of Planck constants and dark matter hierarchy . . . . .	287
4.1.4	Number theoretical symmetries . . . . .	287
4.2	Symmetries . . . . .	288
4.2.1	General Coordinate Invariance and generalized quantum gravitational holography	288
4.2.2	Light like 3-D causal determinants and effective 2-dimensionality . . . . .	289
4.2.3	Magic properties of light cone boundary and isometries of configuration space .	290
4.2.4	Symplectic transformations of $\delta M_+^4 \times CP_2$ as isometries of configuration space	290
4.2.5	Does the symmetric space property reduce to coset construction for Super Vi- rasoro algebras? . . . . .	291
4.2.6	What effective 2-dimensionality and holography really mean? . . . . .	291
4.2.7	About the relationship between super-symplectic and super Kac-Moody algebras	292
4.2.8	Comparison of TGD and stringy views about super-conformal symmetries . . .	295
4.3	Number theoretic compactification and $M^8 - H$ duality . . . . .	297
4.3.1	Basic idea behind $M^8 - M^4 \times CP_2$ duality . . . . .	297
4.3.2	Hyper-octonionic Pauli "matrices" and modified definition of hyper-quaternionicity	298
4.3.3	Minimal form of $M^8 - H$ duality . . . . .	299
4.3.4	Strong form of $M^8 - H$ duality . . . . .	300
4.3.5	$M^8 - H$ duality and low energy hadron physics . . . . .	306
4.3.6	The notion of number theoretical braid . . . . .	307
4.3.7	Connection with string model and Equivalence Principle at space-time level . .	308
4.4	Does modified Dirac action define the fundamental action principle? . . . . .	311
4.4.1	What are the basic equations of quantum TGD? . . . . .	311
4.4.2	Quantum criticality and modified Dirac action . . . . .	312
4.4.3	Handful of problems with a common resolution . . . . .	318
4.4.4	Generalized eigenvalues of $D_{C-S}$ and General Coordinate Invariance . . . . .	327
4.5	Super-conformal symmetries at space-time and configuration space level . . . . .	328
4.5.1	Configuration space as a union of symmetric spaces . . . . .	328
4.5.2	Isometries of configuration space geometry as symplectic transformations of $\delta M_+^4 \times CP_2$ . . . . .	329
4.5.3	SUSY algebra defined by the anticommutation relations of fermionic oscillator operators and WCW local Clifford algebra elements as chiral super-fields . . .	331
4.5.4	Identification of Kac-Moody symmetries . . . . .	333
4.5.5	Coset space structure for configuration space as a symmetric space . . . . .	338
4.5.6	The relationship between super-symplectic and Super Kac-Moody algebras, Equivalence Principle, and justification of p-adic thermodynamics . . . . .	339
4.6	Trying to understand $N = 4$ super-conformal symmetry . . . . .	342
4.6.1	Large $N = 4$ SCA . . . . .	342
4.6.2	Overall view about how different $N = 4$ SCAs could emerge in TGD framework	343
4.6.3	How large $N = 4$ SCA could emerge in quantum TGD? . . . . .	346
4.6.4	Relationship to super string models, M theory and WZW model . . . . .	348
4.6.5	The interpretation of the critical dimension $D = 4$ and the objection related to the signature of the space-time metric . . . . .	349
4.6.6	How could exotic Kac-Moody algebras emerge from Jones inclusions? . . . . .	351
4.6.7	Are both quark and lepton like chiralities needed/possible? . . . . .	352
4.7	Preferred extremals and solutions of the modified Dirac equation and super-conformal symmetries . . . . .	356
4.7.1	Super-conformal symmetries . . . . .	356
4.7.2	What is the role of the right-handed neutrino? . . . . .	357
4.7.3	WCW geometry and super-conformal symmetries . . . . .	361
4.7.4	Equivalence Principle . . . . .	362
4.7.5	Constraints from p-adic mass calculations and ZEO . . . . .	363

4.7.6	The emergence of Yangian symmetry and gauge potentials as duals of Kac-Moody currents . . . . .	364
4.7.7	Quantum criticality and electro-weak gauge symmetries . . . . .	366
4.7.8	The importance of being light-like . . . . .	369
4.7.9	Realization of large $\mathcal{N}$ SUSY in TGD . . . . .	371
4.8	Generalization of the notion of imbedding space . . . . .	374
4.8.1	Generalization of the notion of imbedding space . . . . .	374
4.8.2	Phase transitions changing the value of Planck constant . . . . .	376
4.8.3	Could the dynamics of Kähler action predict the hierarchy of Planck constants? . . . . .	377
<b>5</b>	<b>Construction of Quantum Theory: <math>M</math>-matrix</b>	<b>393</b>
5.1	Introduction . . . . .	393
5.1.1	The recent progress in Quantum TGD and identification of $M$ -matrix . . . . .	393
5.1.2	Various inputs to the construction of $M$ -matrix . . . . .	398
5.1.3	Topics of the chapter . . . . .	402
5.2	Basic philosophical ideas . . . . .	403
5.2.1	Zero energy ontology . . . . .	403
5.2.2	The anatomy of the quantum jump . . . . .	409
5.3	Zero energy ontology and conformal invariance . . . . .	412
5.3.1	$M$ -matrix as characterizer of time-like entanglement between positive and negative energy components of zero energy state . . . . .	413
5.3.2	Feynman rules in configuration space degrees of freedom . . . . .	415
5.3.3	Rational conformal field theories and stringy scattering amplitudes . . . . .	417
5.3.4	Objection against zero energy ontology and quantum classical correspondence . . . . .	422
5.3.5	Issues related to Lorentz symmetry . . . . .	422
5.4	Are both symplectic and conformal field theories needed? . . . . .	425
5.4.1	Symplectic QFT at sphere . . . . .	425
5.4.2	Symplectic QFT with spontaneous breaking of rotational and reflection symmetries . . . . .	426
5.4.3	Generalization to quantum TGD . . . . .	427
5.5	Weak form of electric-magnetic duality and fermionic propagator . . . . .	430
5.5.1	Could Quantum TGD reduce to almost topological QFT? . . . . .	430
5.5.2	A general solution ansatz based on almost topological QFT property . . . . .	433
5.5.3	Hydrodynamic picture in fermionic sector . . . . .	436
5.5.4	Hyper-octonionic primes . . . . .	442
5.5.5	Three basic options for the pseudo-momentum spectrum . . . . .	443
5.6	How to define generalized Feynman diagrams? . . . . .	445
5.6.1	Questions . . . . .	447
5.6.2	Generalized Feynman diagrams at fermionic and momentum space level . . . . .	449
5.6.3	Harmonic analysis in WCW as a manner to calculate WCW functional integrals . . . . .	452
<b>6</b>	<b>Construction of Quantum Theory: More about Matrices</b>	<b>471</b>
6.1	Introduction . . . . .	471
6.2	The latest vision about the role of HFFs in TGD . . . . .	471
6.2.1	Basic facts about factors . . . . .	472
6.2.2	Inclusions and Connes tensor product . . . . .	475
6.2.3	Factors in quantum field theory and thermodynamics . . . . .	477
6.2.4	TGD and factors . . . . .	477
6.2.5	Can one identify $M$ -matrix from physical arguments? . . . . .	482
6.2.6	Finite measurement resolution and HFFs . . . . .	486
6.2.7	Questions about quantum measurement theory in zero energy ontology . . . . .	491
6.2.8	How p-adic coupling constant evolution and p-adic length scale hypothesis emerge from quantum TGD proper? . . . . .	492
6.3	Number theoretic criticality and $M$ -matrix . . . . .	494
6.3.1	Number theoretic constraints on $M$ -matrix . . . . .	494
6.3.2	Physical representations of Galois groups . . . . .	496
6.4	What can one say about the braiding part of $M$ -matrix? . . . . .	501

6.4.1	Are factorizable QFT in $M^2$ and topological QFT in $S^2$ associated with quantum criticality? . . . . .	501
6.4.2	Factorizing 2-D $S$ -matrices and scattering at quantum criticality . . . . .	501
6.4.3	Are unitarity and Lorentz invariance consistent for the quantum critical $M$ -matrix constructed from factorizing $S$ -matrices? . . . . .	508
6.5	What can one say about $U$ -matrix? . . . . .	509
6.5.1	$U$ -matrix as a tensor product of $S$ -matrix part of $M$ -matrix and its Hermitian conjugate? . . . . .	509
6.5.2	The unitarity conditions of $U$ -matrix for HFFs of type $II_1$ ? . . . . .	510
6.5.3	$U$ -matrix can have elements between different number fields . . . . .	510
6.5.4	Feynman diagrams as higher level particles and their scattering as dynamics of self consciousness . . . . .	511
6.6	The master formula for the $U$ -matrix finally found? . . . . .	514
6.6.1	What is the master formula for the $U$ -matrix? . . . . .	515
6.6.2	Universal formula for the hermitian square roots of density matrix . . . . .	516
6.6.3	Bosonic part of the action . . . . .	517
6.6.4	Fermionic part of the action . . . . .	518
6.6.5	Definition of $U$ -matrix . . . . .	519
6.6.6	What is the relationship of generalized Feynman diagrams to twistor diagrams? . . . . .	520
6.6.7	Generalized twistor diagrams and planar operads . . . . .	523
6.7	Anatomy of quantum jump in zero energy ontology . . . . .	523
6.7.1	Generalization of $S$ -matrix . . . . .	524
6.7.2	A concise description of quantum jump . . . . .	525
6.7.3	Questions and answers . . . . .	527
6.7.4	More about the anatomy of state function reduction . . . . .	528
<b>7</b>	<b>Category Theory and Quantum TGD</b>	<b>547</b>
7.1	Introduction . . . . .	547
7.2	$S$ -matrix as a functor . . . . .	547
7.2.1	The $*$ -category of Hilbert spaces . . . . .	548
7.2.2	The monoidal $*$ -category of Hilbert spaces and its counterpart at the level of $n\text{Cob}$ . . . . .	548
7.2.3	TQFT as a functor . . . . .	549
7.2.4	The situation is in TGD framework . . . . .	549
7.3	Further ideas . . . . .	552
7.3.1	Operads, number theoretical braids, and inclusions of HFFs . . . . .	552
7.3.2	Generalized Feynman diagram as category? . . . . .	553
7.4	Planar operads, the notion of finite measurement resolution, and arrow of geometric time . . . . .	554
7.4.1	Zeroth order heuristics about zero energy states . . . . .	554
7.4.2	Planar operads . . . . .	555
7.4.3	Planar operads and zero energy states . . . . .	555
7.4.4	Relationship to ordinary Feynman diagrammatics . . . . .	557
7.5	Category theory and symplectic QFT . . . . .	557
7.5.1	Fusion rules . . . . .	558
7.5.2	What conditions could fix the symplectic triangles? . . . . .	558
7.5.3	Associativity conditions and braiding . . . . .	561
7.5.4	Finite-dimensional version of the fusion algebra . . . . .	562
7.6	Could operads allow the formulation of the generalized Feynman rules? . . . . .	567
7.6.1	How to combine conformal fields with symplectic fields? . . . . .	567
7.6.2	Symplecto-conformal fields in Super-Kac-Moody sector . . . . .	568
7.6.3	The treatment of four-momentum and other quantum numbers . . . . .	569
7.6.4	What does the improvement of measurement resolution really mean? . . . . .	571
7.6.5	How do the operads formed by generalized Feynman diagrams and symplecto-conformal fields relate? . . . . .	572
7.7	Possible other applications of category theory . . . . .	574
7.7.1	Categorification and finite measurement resolution . . . . .	574
7.7.2	Inclusions of HFFs and planar tangles . . . . .	576

7.7.3	2-plectic structures and TGD . . . . .	576
7.7.4	TGD variant for the category nCob . . . . .	577
7.7.5	Number theoretical universality and category theory . . . . .	578
7.7.6	Category theory and fermionic parts of zero energy states as logical deductions . . . . .	578
7.7.7	Category theory and hierarchy of Planck constants . . . . .	578
 <b>III TWISTORS, BOSONIC EMERGENCE, SPACE-TIME SUPER-SYMMETRY</b>		<b>589</b>
<b>8</b>	<b>Twistors, <math>N = 4</math> Super-Conformal Symmetry, and Quantum TGD</b>	<b>591</b>
8.1	Introduction . . . . .	591
8.1.1	Twistors and classical TGD . . . . .	592
8.1.2	Twistors and Feynman diagrams . . . . .	593
8.1.3	Massive particles and the generalization of twistors to 8-D case . . . . .	593
8.1.4	Twistors and electric-magnetic duality . . . . .	594
8.2	Could the target space be identified in terms of twistors? . . . . .	594
8.2.1	General remarks . . . . .	595
8.2.2	What twistor Fourier transform could mean in TGD framework? . . . . .	595
8.2.3	Could one define the phase factor of the twistor uniquely? . . . . .	597
8.3	Could one regard space-time surfaces as surfaces in twistor space? . . . . .	598
8.3.1	How $M^4 \times CP_2$ emerges in twistor context? . . . . .	598
8.3.2	How to identify twistorial surfaces in $PT \times CP_2$ and how to map them to $M^4 \times CP_2$ ? . . . . .	598
8.3.3	How to code the basic parameters of preferred extremals in terms of twistors? . . . . .	599
8.3.4	Hyper-quaternionic and co-hyper-quaternionic surfaces and twistor duality . . . . .	601
8.4	Could one lift Feynman diagrams to twistor space? . . . . .	601
8.4.1	The treatment of massive case in terms of twistors . . . . .	601
8.4.2	Purely twistorial formulation of Feynman graphs . . . . .	602
8.4.3	What could be the propagator in twistor space? . . . . .	604
8.4.4	What to do with the perturbation theory? . . . . .	605
8.5	Could one generalize the notion of twistor to 8-D case? . . . . .	605
8.5.1	Octo-twistors defined in terms of ordinary spinors . . . . .	606
8.5.2	Could right handed neutrino spinor modes define octo-twistors? . . . . .	607
8.5.3	Octo-twistors and modified Dirac equation . . . . .	607
8.5.4	What one really means with a virtual particle? . . . . .	614
8.6	Does weak form of electric-magnetic duality lead to a twistorial description? . . . . .	620
8.6.1	The simplest vision about how twistors might emerge from TGD . . . . .	620
8.6.2	Generalized eigen modes for the modified Chern-Simons Dirac equation and hydrodynamical picture . . . . .	621
8.6.3	Generalized Feynman diagrams at fermionic and momentum space level . . . . .	622
8.6.4	Hyper-octonionic primes . . . . .	629
8.6.5	Generalized Feynman diagrams at fermionic and momentum space level . . . . .	630
8.6.6	Three basic options for the pseudo-momentum spectrum . . . . .	633
<b>9</b>	<b>Yangian Symmetry, Twistors, and TGD</b>	<b>649</b>
9.1	Introduction . . . . .	649
9.1.1	Background . . . . .	649
9.1.2	Yangian symmetry . . . . .	650
9.2	How to generalize Yangian symmetry in TGD framework? . . . . .	651
9.2.1	Is there any hope about description in terms of Grassmannians? . . . . .	652
9.2.2	Could zero energy ontology make possible full Yangian symmetry? . . . . .	654
9.2.3	Could Yangian symmetry provide a new view about conserved quantum numbers? . . . . .	654
9.2.4	What about the selection of preferred $M^2 \subset M^4$ ? . . . . .	655
9.2.5	Does $M^8 - H$ duality generalize the duality between twistor and momentum twistor descriptions? . . . . .	656
9.3	Some mathematical details about Grassmannian formalism . . . . .	658
9.3.1	Yangian algebra and its super counterpart . . . . .	659

9.3.2	Twistors and momentum twistors and super-symmetrization . . . . .	662
9.3.3	Brief summary of the work of Arkani-Hamed and collaborators . . . . .	665
9.3.4	The general form of Grassmannian integrals . . . . .	666
9.3.5	Canonical operations for Yangian invariants . . . . .	668
9.3.6	Explicit formula for the recursion relation . . . . .	671
9.4	Could the Grassmannian program be realized in TGD framework? . . . . .	672
9.4.1	What Yangian symmetry could mean in TGD framework? . . . . .	672
9.4.2	How to achieve Yangian invariance without trivial scattering amplitudes? . . .	674
9.4.3	Number theoretical constraints on the pseudo-momenta . . . . .	675
9.4.4	Could recursion formula allow interpretation in terms of zero energy ontology?	676
9.4.5	What about unitarity? . . . . .	678
9.5	Could TGD allow formulation in terms of twistors . . . . .	679
9.5.1	$M^4 \times CP_2$ from twistor approach . . . . .	679
9.5.2	Does twistor string theory generalize to TGD? . . . . .	680
9.5.3	What is the relationship of TGD to M-theory and F-theory? . . . . .	682
9.5.4	What could the field equations be in twistorial formulation? . . . . .	683
9.6	Comparing twistor revolution with TGD revolution . . . . .	690
9.6.1	The declaration of revolution by Nima from TGD point of view . . . . .	690
9.6.2	Basic results of twistor approach from TGD point of view . . . . .	692
9.6.3	Could planar diagrams be enough in the theory transcending $\mathcal{N} = 4$ SUSY? . .	694
9.6.4	Motives and twistors . . . . .	694
9.6.5	Reducing non-planar diagrams to planar ones by a generalization of algorithm for calculating knot invariants? . . . . .	695
9.6.6	Langlands duality, electric-magnetic duality, S-duality, finite measurement res- olution, and quantum Yangian symmetry . . . . .	696
9.6.7	About the structure of the Yangian algebra . . . . .	698
9.7	More about twistor revolution and TGD . . . . .	701
9.7.1	The origin of twistor diagrammatics . . . . .	702
9.7.2	The emergence of 2-D sub-dynamics at space-time level . . . . .	702
9.7.3	The emergence of Yangian symmetry . . . . .	703
9.7.4	The analog of $AdS^5$ duality in TGD framework . . . . .	704
9.7.5	Problems of the twistor approach from TGD point of view . . . . .	705
9.7.6	Still one attempt understand generalized Feynman diagrams . . . . .	706
9.8	Does the exponent of Chern-Simons action reduce to the exponent of the area of minimal surfaces? . . . . .	711
9.8.1	Why Chern-Simons action should reduce to area for minimal surfaces? . . . . .	711
9.8.2	IR cutoff and connection with p-adic physics . . . . .	713
9.8.3	Could Kähler action reduce to Kähler magnetic flux over string world sheets and partonic 2-surfaces? . . . . .	713
9.8.4	What is the interpretation of Yangian duality in TGD framework? . . . . .	714
<b>10</b>	<b>Quantum Field Theory Limit of TGD from Bosonic Emergence</b>	<b>727</b>
10.1	Introduction . . . . .	727
10.1.1	The dream . . . . .	727
10.1.2	Improved dream . . . . .	728
10.1.3	SUSY improved dream . . . . .	729
10.1.4	ZEO improved dream . . . . .	730
10.1.5	What can one conclude? . . . . .	730
10.2	Bootstrap approach to obtain a unitary S-matrix . . . . .	731
10.2.1	Quantitative realization of UV finiteness in terms of p-adic length scale hypoth- esis and finite measurement resolution . . . . .	731
10.2.2	A more detailed summary of Feynman diagrammatics . . . . .	738
10.2.3	Could quantum criticality fix hyperbolic cutoff uniquely? . . . . .	746
10.3	Calculation of the bosonic propagator . . . . .	747
10.3.1	The basic integrals . . . . .	747
10.3.2	How to avoid generation of mass term? . . . . .	748
10.3.3	Explicit form of the integrals . . . . .	749



10.3.4	k-integration for the principal value parts of the integrals . . . . .	751
10.3.5	Numerical calculation of the integrals over the hyperbolic angle . . . . .	754
10.3.6	The evolution of $1/\alpha_{em}(p)$ for given IR cutoff for loop momenta . . . . .	764
10.4	How quantum criticality could predict the evolution of hyperbolic cutoff? . . . . .	766
10.4.1	Summary about how ideas about quantum criticality have evolved . . . . .	766
10.4.2	Searching for the solutions of criticality conditions . . . . .	769
10.4.3	Could p-adic fractality solve the problems? . . . . .	776
10.5	Further progress . . . . .	784
10.5.1	Could supersymmetry make momentum cutoffs un-necessary? . . . . .	784
10.5.2	Generalized Feynman diagrams at fermionic and momentum space level . . . . .	787
10.5.3	Trying to understand the QFT limit of TGD . . . . .	790
<b>11</b>	<b>Does the QFT Limit of TGD Have Space-Time Super-Symmetry?</b>	<b>805</b>
11.1	Introduction . . . . .	805
11.2	SUSY briefly . . . . .	808
11.2.1	Weyl fermions . . . . .	809
11.2.2	SUSY algebras . . . . .	809
11.2.3	Super-space . . . . .	812
11.2.4	Non-renormalization theorems . . . . .	814
11.3	Does TGD allow the counterpart of space-time super-symmetry? . . . . .	815
11.3.1	Basic data bits . . . . .	815
11.3.2	Could one generalize super-symmetry? . . . . .	816
11.3.3	Modified Dirac equation briefly . . . . .	816
11.3.4	TGD counterpart of space-time super-symmetry . . . . .	817
11.3.5	Experimental indication for space-time super-symmetry . . . . .	818
11.4	Octo-twistors and modified Dirac equation . . . . .	819
11.4.1	The replacement of $SO(7, 1)$ with $G_2$ . . . . .	821
11.4.2	Octonionic counterpart of the modified Dirac equation . . . . .	823
11.4.3	Could the notion of octo-twistor make sense? . . . . .	826
11.5	SUSY algebra of fermionic oscillator operators and WCW local Clifford algebra elements as super-fields . . . . .	827
11.5.1	Super-algebra associated with the modified gamma matrices . . . . .	828
11.5.2	Super-fields associated with WCW Clifford algebra . . . . .	829
11.6	SUSY algebra at QFT limit . . . . .	830
11.6.1	Minimum information about space-time sheet and particle quantum numbers needed to formulate SUSY algebra . . . . .	831
11.6.2	The physical picture behind the realization of SUSY algebra at point like limit . . . . .	831
11.6.3	Explicit form of the SUSY algebra at QFT limit . . . . .	833
11.6.4	How the representations of SUSY in TGD differ from the standard representations? . . . . .	834
11.7	Super-symmetric QFT limit of TGD . . . . .	835
11.7.1	Basic concepts and ideas . . . . .	835
11.7.2	About super-field formalism in $\mathcal{N} = 2$ case . . . . .	838
11.7.3	Electric magnetic duality, monopole condensation and confinement from TGD point view . . . . .	839
11.7.4	Interpretation of Kähler potential and super-potential terms in TGD framework . . . . .	841
11.7.5	Generalization of bosonic emergence . . . . .	841
11.7.6	Is $\mathcal{N} > 8$ super-symmetry internally consistent? . . . . .	841
11.7.7	Super-fields in TGD framework . . . . .	842
11.7.8	Could QFT limit be finite? . . . . .	846
11.7.9	Can one understand p-adic coupling constant evolution as a prediction of QFT limit? . . . . .	847
11.7.10	Is the QFT type description of gravitational interactions possible? . . . . .	849
11.8	A more detailed summary of Feynman diagrammatics for emergence . . . . .	853
11.8.1	Emergence in absence of super-symmetry . . . . .	854
11.8.2	Some differences from standard Feynman diagrammatics . . . . .	854
11.8.3	Generalization of the formalism to the super-symmetric case . . . . .	855
11.9	Could $\mathcal{N} = 2$ or $\mathcal{N} = 4$ SUSY be a part of TGD after all? . . . . .	855

11.9.1	Scattering amplitudes and the positive Grassmannian . . . . .	856
11.9.2	Could $\mathcal{N} = 2$ or $\mathcal{N} = 4$ SUSY have something to do with TGD? . . . . .	858
<b>12</b>	<b>Generalized Feynman Graphs as Generalized Braids</b>	<b>877</b>
12.1	Introduction . . . . .	877
12.2	Algebraic braids, sub-manifold braid theory, and generalized Feynman diagrams . . . . .	878
12.2.1	Generalized Feynman diagrams, Feynman diagrams, and braid diagrams . . . . .	878
12.2.2	Brief summary of algebraic knot theory . . . . .	880
12.2.3	Generalized Feynman diagrams as generalized braid diagrams? . . . . .	882
12.2.4	About string world sheets, partonic 2-surfaces, and two-knots . . . . .	887
12.2.5	What generalized Feynman rules could be? . . . . .	894
12.3	Duality between low energy and high energy descriptions of hadron physics . . . . .	899
12.3.1	Weak form of electric magnetic duality and bosonic emergence . . . . .	899
12.3.2	The dual interpretations of generalized Feynman diagrams in terms of hadronic and partonic reaction vertices . . . . .	900
12.3.3	Reconnection of color magnetic flux tubes . . . . .	901
12.3.4	Hadron-parton duality and TGD as a "square root" of the statistical QCD description . . . . .	902
12.4	Quark gluon plasma in TGD framework . . . . .	902
12.4.1	Some points in Son's talk . . . . .	902
12.4.2	What is known about quark-gluon plasma? . . . . .	903
12.4.3	Gauge-gravity duality in TGD framework . . . . .	904
12.4.4	TGD view about strongly interacting quark gluon plasma . . . . .	907
12.4.5	AdS/CFT is not favored by LHC . . . . .	909
12.5	Proposal for a twistorial description of generalized Feynman graphs . . . . .	911
12.5.1	What generalized Feynman diagrams could be? . . . . .	912
12.5.2	Number theoretical universality and quantum arithmetics . . . . .	915
12.5.3	How to understand renormalization flow in twistor context? . . . . .	917
12.5.4	Comparison with $\mathcal{N} = 4$ SYM . . . . .	918
12.5.5	Very Special Relativity as justification for the special role of $M^2$ . . . . .	919
<b>IV</b>	<b>HYPER-FINITE FACTORS AND HIERARCHY OF PLANCK CON-</b>	
	<b>STANTS</b>	<b>935</b>
<b>13</b>	<b>Was von Neumann Right After All?</b>	<b>937</b>
13.1	Introduction . . . . .	937
13.1.1	Philosophical ideas behind von Neumann algebras . . . . .	937
13.1.2	Von Neumann, Dirac, and Feynman . . . . .	938
13.1.3	Hyper-finite factors in quantum TGD . . . . .	938
13.1.4	Hyper-finite factors and M-matrix . . . . .	939
13.1.5	Connes tensor product as a realization of finite measurement resolution . . . . .	939
13.1.6	Quantum spinors and fuzzy quantum mechanics . . . . .	940
13.2	Von Neumann algebras . . . . .	940
13.2.1	Basic definitions . . . . .	940
13.2.2	Basic classification of von Neumann algebras . . . . .	941
13.2.3	Non-commutative measure theory and non-commutative topologies and geometries	941
13.2.4	Modular automorphisms . . . . .	942
13.2.5	Joint modular structure and sectors . . . . .	943
13.2.6	Basic facts about hyper-finite factors of type III . . . . .	943
13.3	Braid group, von Neumann algebras, quantum TGD, and formation of bound states . . . . .	945
13.3.1	Factors of von Neumann algebras . . . . .	945
13.3.2	Sub-factors . . . . .	946
13.3.3	$II_1$ factors and the spinor structure of infinite-dimensional configuration space of 3-surfaces . . . . .	946
13.3.4	About possible space-time correlates for the hierarchy of $II_1$ sub-factors . . . . .	948

13.3.5	Could binding energy spectra reflect the hierarchy of effective tensor factor dimensions? . . . . .	949
13.3.6	Four-color problem, $II_1$ factors, and anyons . . . . .	950
13.4	Inclusions of $II_1$ and $III_1$ factors . . . . .	951
13.4.1	Basic findings about inclusions . . . . .	951
13.4.2	The fundamental construction and Temperley-Lieb algebras . . . . .	952
13.4.3	Connection with Dynkin diagrams . . . . .	953
13.4.4	Indices for the inclusions of type $III_1$ factors . . . . .	954
13.5	TGD and hyper-finite factors of type $II_1$ : ideas and questions . . . . .	954
13.5.1	What kind of hyper-finite factors one can imagine in TGD? . . . . .	954
13.5.2	Direct sum of HFFs of type $II_1$ as a minimal option . . . . .	956
13.5.3	Bott periodicity, its generalization, and dimension $D = 8$ as an inherent property of the hyper-finite $II_1$ factor . . . . .	957
13.5.4	The interpretation of Jones inclusions in TGD framework . . . . .	958
13.5.5	Configuration space, space-time, and imbedding space and hyper-finite type $II_1$ factors . . . . .	960
13.5.6	Quaternions, octonions, and hyper-finite type $II_1$ factors . . . . .	962
13.5.7	Does the hierarchy of infinite primes relate to the hierarchy of $II_1$ factors? . . . . .	965
13.6	Could HFFs of type $III$ have application in TGD framework? . . . . .	966
13.6.1	Problems associated with the physical interpretation of $III_1$ factors . . . . .	966
13.6.2	Quantum measurement theory and HFFs of type $III$ . . . . .	967
13.6.3	What could one say about $II_1$ automorphism associated with the $II_\infty$ automorphism defining factor of type $III$ ? . . . . .	969
13.6.4	What could be the physical interpretation of two kinds of invariants associated with HFFs type $III$ ? . . . . .	969
13.6.5	Does the time parameter $t$ represent time translation or scaling? . . . . .	970
13.6.6	Could HFFs of type $III$ be associated with the dynamics in $M_\pm^4$ degrees of freedom? . . . . .	971
13.6.7	Could the continuation of braidings to homotopies involve $\Delta^{it}$ automorphisms . . . . .	972
13.6.8	HFFs of type $III$ as super-structures providing additional uniqueness? . . . . .	972
13.7	The almost latest vision about the role of HFFs in TGD . . . . .	972
13.7.1	Basic facts about factors . . . . .	973
13.7.2	Inclusions and Connes tensor product . . . . .	976
13.7.3	Factors in quantum field theory and thermodynamics . . . . .	978
13.7.4	TGD and factors . . . . .	978
13.7.5	Can one identify $M$ -matrix from physical arguments? . . . . .	983
13.7.6	Finite measurement resolution and HFFs . . . . .	987
13.7.7	Questions about quantum measurement theory in zero energy ontology . . . . .	992
13.7.8	How p-adic coupling constant evolution and p-adic length scale hypothesis emerge from quantum TGD proper? . . . . .	994
13.7.9	Planar algebras and generalized Feynman diagrams . . . . .	996
13.7.10	Miscellaneous . . . . .	998
13.8	Fresh view about hyper-finite factors in TGD framework . . . . .	999
13.8.1	Crystals, quasicrystals, non-commutativity and inclusions of hyperfinite factors of type $II_1$ . . . . .	1000
13.8.2	HFFs and their inclusions in TGD framework . . . . .	1001
13.8.3	Little Appendix: Comparison of WCW spinor fields with ordinary second quantized spinor fields . . . . .	1003
13.9	Jones inclusions and cognitive consciousness . . . . .	1004
13.9.1	Does one have a hierarchy of $U$ - and $M$ -matrices? . . . . .	1005
13.9.2	Feynman diagrams as higher level particles and their scattering as dynamics of self consciousness . . . . .	1005
13.9.3	Logic, beliefs, and spinor fields in the world of classical worlds . . . . .	1008
13.9.4	Jones inclusions for hyperfinite factors of type $II_1$ as a model for symbolic and cognitive representations . . . . .	1009
13.9.5	Intentional comparison of beliefs by topological quantum computation? . . . . .	1011
13.9.6	The stability of fuzzy qbits and quantum computation . . . . .	1012

13.9.7	Fuzzy quantum logic and possible anomalies in the experimental data for the EPR-Bohm experiment . . . . .	1012
13.9.8	Category theoretic formulation for quantum measurement theory with finite measurement resolution? . . . . .	1014
13.10	Appendix: Inclusions of hyper-finite factors of type $II_1$ . . . . .	1016
13.10.1	Jones inclusions . . . . .	1017
13.10.2	Wassermann's inclusion . . . . .	1017
13.10.3	Generalization from $SU(2)$ to arbitrary compact group . . . . .	1018
<b>14</b>	<b>Does TGD Predict Spectrum of Planck Constants?</b>	<b>1035</b>
14.1	Introduction . . . . .	1035
14.1.1	The evolution of mathematical ideas . . . . .	1035
14.1.2	The evolution of physical ideas . . . . .	1038
14.1.3	Brief summary about the generalization of the imbedding space concept . . . . .	1038
14.1.4	Basic physical picture as it is now . . . . .	1039
14.1.5	Space-time correlates for the hierarchy of Planck constants . . . . .	1040
14.2	Experimental input . . . . .	1041
14.2.1	Hints for the existence of large $\hbar$ phases . . . . .	1041
14.2.2	Quantum coherent dark matter and $\hbar$ . . . . .	1042
14.2.3	The phase transition changing the value of Planck constant as a transition to non-perturbative phase . . . . .	1043
14.3	A generalization of the notion of imbedding space as a realization of the hierarchy of Planck constants . . . . .	1043
14.3.1	Basic ideas . . . . .	1044
14.3.2	The vision . . . . .	1045
14.3.3	Hierarchy of Planck constants and the generalization of the notion of imbedding space . . . . .	1047
14.4	Updated view about the hierarchy of Planck constants . . . . .	1051
14.4.1	Basic physical ideas . . . . .	1051
14.4.2	Space-time correlates for the hierarchy of Planck constants . . . . .	1052
14.4.3	Basic phenomenological rules of thumb in the new framework . . . . .	1053
14.4.4	Charge fractionalization and anyons . . . . .	1054
14.4.5	Negentropic entanglement between branches of multi-furcations . . . . .	1055
14.4.6	Dark variants of nuclear and atomic physics . . . . .	1056
14.4.7	What about the relationship of gravitational Planck constant to ordinary Planck constant? . . . . .	1057
14.4.8	How the effective hierarchy of Planck constants could reveal itself in condensed matter physics . . . . .	1058
14.4.9	Summary . . . . .	1060
14.5	Vision about dark matter as phases with non-standard value of Planck constant . . . . .	1060
14.5.1	Dark rules . . . . .	1060
14.5.2	Phase transitions changing Planck constant . . . . .	1061
14.5.3	Coupling constant evolution and hierarchy of Planck constants . . . . .	1062
14.6	Some applications . . . . .	1063
14.6.1	A simple model of fractional quantum Hall effect . . . . .	1064
14.6.2	Gravitational Bohr orbitology . . . . .	1065
14.6.3	Accelerating periods of cosmic expansion as phase transitions increasing the value of Planck constant . . . . .	1069
14.6.4	Phase transition changing Planck constant and expanding Earth theory . . . . .	1071
14.6.5	Allais effect as evidence for large values of gravitational Planck constant? . . . . .	1076
14.6.6	Applications to elementary particle physics, nuclear physics, and condensed matter physics . . . . .	1077
14.6.7	Applications to biology and neuroscience . . . . .	1078
14.7	Appendix . . . . .	1083
14.7.1	About inclusions of hyper-finite factors of type $II_1$ . . . . .	1083
14.7.2	Generalization from $SU(2)$ to arbitrary compact group . . . . .	1085

<b>15</b>	<b>Mathematical Speculations about the Hierarchy of Planck Constants</b>	<b>1109</b>
15.1	Introduction . . . . .	1109
15.2	Jones inclusions and generalization of the imbedding space . . . . .	1110
15.2.1	Basic facts about Jones inclusions . . . . .	1110
15.2.2	Jones inclusions and the hierarchy of Planck constants . . . . .	1111
15.2.3	Questions . . . . .	1114
15.3	Some mathematical speculations . . . . .	1116
15.3.1	The content of McKay correspondence in TGD framework . . . . .	1116
15.3.2	Jones inclusions, the large $N$ limit of $SU(N)$ gauge theories and AdS/CFT correspondence . . . . .	1120
15.3.3	Could McKay correspondence and Jones inclusions relate to each other? . . . .	1123
15.3.4	Farey sequences, Riemann hypothesis, tangles, and TGD . . . . .	1127
15.3.5	Only the quantum variants of $M^4$ and $M^8$ emerge from local hyper-finite $II_1$ factors . . . . .	1130
<b>1</b>	<b>Appendix</b>	<b>1145</b>
A-1	Introduction . . . . .	1145
A-2	Hopf algebras and ribbon categories as basic structures . . . . .	1145
A-2.1	Hopf algebras and ribbon categories very briefly . . . . .	1145
A-2.2	Algebras, co-algebras, bi-algebras, and related structures . . . . .	1146
A-2.3	Tensor categories . . . . .	1156
A-3	Axiomatic approach to S-matrix based on the notion of quantum category . . . . .	1163
A-3.1	$\Delta$ and $\mu$ and the axioms eliminating loops . . . . .	1164
A-3.2	The physical interpretation of non-trivial braiding and quasi-associativity . . .	1165
A-3.3	Generalizing the notion of bi-algebra structures at the level of configuration space	1165
A-3.4	Ribbon category as a fundamental structure? . . . . .	1167
A-3.5	Minimal models and TGD . . . . .	1168
A-4	Some examples of bi-algebras and quantum groups . . . . .	1170
A-4.1	Hecke algebra and Temperley-Lieb algebra . . . . .	1170
A-4.2	Simplest bi-algebras . . . . .	1171
A-4.3	Quantum group $U_q(sl(2))$ . . . . .	1172
A-4.4	General semisimple quantum group . . . . .	1173
A-4.5	Quantum affine algebras . . . . .	1174
A-5	Basic properties of $CP_2$ and elementary facts about p-adic numbers . . . . .	1185
A-5.1	$CP_2$ as a manifold . . . . .	1185
A-5.2	Metric and Kähler structure of $CP_2$ . . . . .	1186
A-5.3	Spinors in $CP_2$ . . . . .	1188
A-5.4	Geodesic sub-manifolds of $CP_2$ . . . . .	1189
A-6	$CP_2$ geometry and standard model symmetries . . . . .	1189
A-6.1	Identification of the electro-weak couplings . . . . .	1189
A-6.2	Discrete symmetries . . . . .	1193
A-7	Basic facts about induced gauge fields . . . . .	1193
A-7.1	Induced gauge fields for space-times for which $CP_2$ projection is a geodesic sphere	1193
A-7.2	Space-time surfaces with vanishing em, $Z^0$ , or Kähler fields . . . . .	1194
A-8	p-Adic numbers and TGD . . . . .	1196
A-8.1	p-Adic number fields . . . . .	1196
A-8.2	Canonical correspondence between p-adic and real numbers . . . . .	1197



# List of Figures

2.1	The projection of the bifurcation set of the swallowtail catastrophe to the 3-dimensional space of control variables. The potential function has four extrema in the interior of the swallowtail bounded by the triangles, no extrema in the valley above the swallowtail, and 2 extrema elsewhere. . . . .	83
2.2	Cusp catastrophe. Vertical direction corresponds to the behavior variable and orthogonal directions to control variables. . . . .	84
2.3	Topological sum of $CP_2$ 's as Feynman graph with lines thickened to four-manifolds . . .	87
10.1	The evolution of the ratio $r = \alpha_{em}/\alpha_{em,pred}(p)$ , where $\alpha_{em}$ is the experimentally determined value of the fine structure constant at electron length scale and $\alpha_{em,pred}(p_k)$ for $p_k = \sqrt{2}m_k = 2^{-(k-1)/2}xm(CP_2)$ , $k = 2, \dots, 127$ , $x \in \{2^{-1/2}, 2^{-1/4}, 1\}$ . Note that the three points correspond to the lower end, middle point, and upper end of the p-adic mass scale range labeled by the integer $k_0$ . . . . .	765
10.2	The graph represents the quantity $Im(X)\alpha_{em}$ , where $Im(X)$ is imaginary pole contribution to the normalization factor of the inverse propagator for momenta $p_{k_0} = \sqrt{2}m_k = 2^{-(k_0-1)/2}xm(CP_2)$ , $k = 1, \dots, 127$ , $x \in \{2^{-1/2}, 2^{-1/4}, 1\}$ and assuming $k_{max} = 127$ . . .	765
10.3	The evolution of the ratio $r = \alpha_{em}/\alpha_{em,pred}(p_k)$ for $k_{max} = 89$ as IR cutoff for loop corrections and for momenta $p_k = \sqrt{2}m_k = 2^{-(k-1)/2}xm(CP_2)$ , $k = 90, 127$ , $x \in \{2^{-1/2}, 2^{-1/4}, 1\}$ . . . . .	766
10.4	The quantity $X(k)\alpha_{em}$ characterizing the contribution from a given p-adic length scale $k$ to $1/\alpha_{em}(p)$ as a function of p-adic length scale $k$ for IR cutoff $k_{max} = 127$ and $p = \sqrt{2} \times 2^{-k_0/2}mCP_2$ , $k_0 = 89$ . . . . .	767
10.5	The quantity $X(k)\alpha_{em}$ characterizing the contribution from a given p-adic length scale $k$ to $1/\alpha_{em}(p)$ as a function of p-adic length scale $k$ for IR cutoff $k_{max} = 89$ and $k_0 = 107$ .	767
10.6	The graph represents the ratio $p(k + n(k))/m(k + n(k))$ of the critical mass to the p-adic mass scale having variation range $[1, \sqrt{2}]$ . Second graph representing $n(k_{max})$ demonstrates the correlation between the two plots. The values of the calculated ratio at the upper end are not exact since the convergence to the actual value, presumably equal to $\sqrt{2}$ , is so slow that calculation does not reach the zero in the available calculation time. . . . .	771
10.7	The hyperbolic cutoff $\sinh(\eta_{max}(k))$ for the model of criticality with $\sinh(\eta_{max}(1)) = 0.09660156250000$ assuming that critical momentum corresponds to the vanishing of both $1/\alpha_{em}$ and $\partial_u max 1/\alpha_{em}$ so that critical momentum as near as possible to an end point of half octave. . . . .	776
10.8	The ratio $r = cut(k + 1)/cut(k)$ for the hyperbolic cutoff $cut(k) \equiv \sinh(\eta_{max}(k))$ as function of $k$ for three values of $cut(1)$ is in reasonable approximation constant so that $cut(k)$ increases exponentially. For certain critical value $r$ begins to increase rapidly. . .	777
1	Graphical representation for the axioms of algebra. a) $a(bc) = (ab)c$ , b) $ab = ba$ , c) $ka = \mu(\eta(k), a)$ and $ak = \mu(a, \eta(k))$ . . . . .	1148
2	Graphical representation for the axioms of co-algebra is obtained by turning the representation for algebra axioms upside down. a) $(id \otimes \Delta)\Delta = (\Delta \otimes id)\Delta$ , b) $\Delta = \Delta^{op}$ , c) $(\epsilon \otimes id) \circ \Delta = (id \otimes \epsilon) \circ \Delta = id$ . . . . .	1149

3	Graphical representation for the conditions guaranteing that $\mu$ and $\eta$ ( $\Delta$ and $\epsilon$ ) act as homomorphisms of co-algebra (algebra). a) $(id \otimes \mu \otimes id)(\Delta \otimes \Delta) = \Delta \circ \mu$ , b) $\epsilon \circ \mu = id \circ (\epsilon \otimes \epsilon)$ , c) $\Delta \circ \eta = \mu \otimes id_k$ , d) $\epsilon \circ \eta = id_k$ . . . . .	1151
4	Graphical representation of antipode axiom $S \star id_H = id_H \star S = \eta \circ \epsilon$ . . . . .	1152
5	Graphical representation of the duality condition $\langle uv, x \rangle = \langle u \otimes v, \Delta(x) \rangle$ . . . . .	1152
6	Graphical representation of Yang-Baxter equation $R_{12}R_{13}R_{23} = R_{23}R_{13}R_{12}$ . . . . .	1154
7	The graphical representation of morphisms. a) $g \circ f: V \rightarrow W$ , b) $f \otimes g$ , c) $f : U_1 \otimes \dots \otimes U_m \rightarrow V_1 \otimes \dots \otimes V_n$ . . . . .	1158
8	Graphical representations of a) the associativity isomorphism $a_{U,V,W}$ , b) Triangle Axiom, c) Pentagon Axiom. . . . .	1159
9	Graphical representations a) of the braiding morphism $c_{V,W}$ and its inverse $c_{V,W}^{-1}$ , b) of naturality of $c_{V,W}$ , c) of First Hexagon Axiom. . . . .	1162
10	Graphical representations a) of the morphisms $b_V$ and $d_V$ , b) of the transpose $f^*$ , c) of braiding operation $c_{V^*,W}$ expressed in terms of $c_{V,W}$ . . . . .	1162
11	Graphical representations a) of $\theta_{V \otimes W} = \theta_V \otimes \theta_W c_{W,V} c_{V,W}$ , b) of $\theta_{V^*} = (\theta_V)^*$ , c) of $\theta_W f = f \theta_V$ , d) of right duality for a ribbon category. . . . .	1163
12	Graphical representations of a) $tr_q(f)$ , b) of $tr_q(fg) = tr_q(gf)$ , c) of $tr(f \otimes g) = tr(f)tr(g)$ . . . . .	1163
13	Graphical representations for the conditions a) $(id \otimes \mu \otimes id)(\Delta \otimes \Delta) = \Delta \circ \mu$ , b) $\mu_{B \otimes C \rightarrow A} \circ \Delta_{A \rightarrow B \otimes C} = K \times id_A$ , and c) $(\mu \otimes id) \circ (\Delta \otimes id) \circ \Delta = K \times \Delta$ . . . . .	1164
14	The real norm induced by canonical identification from 2-adic norm. . . . .	1198



# Chapter 1

## Introduction

### 1.1 Basic Ideas of TGD

The basic physical picture behind TGD was formed as a fusion of two rather disparate approaches: namely TGD as a Poincare invariant theory of gravitation and TGD as a generalization of the old-fashioned string model.

#### 1.1.1 Background

*T(opological) G(eometro)D(ynamics)* is one of the many attempts to find a unified description of basic interactions. The development of the basic ideas of TGD to a relatively stable form took time of about half decade [K1]. The great challenge is to construct a mathematical theory around these physically very attractive ideas and I have devoted the last twenty-three years for the realization of this dream and this has resulted in seven online books about TGD and eight online books about TGD inspired theory of consciousness and of quantum biology.

Quantum T(opological) G(eometro)D(ynamics) as a classical spinor geometry for infinite-dimensional configuration space, p-adic numbers and quantum TGD, and TGD inspired theory of consciousness and of quantum biology have been for last decade of the second millenium the basic three strongly interacting threads in the tapestry of quantum TGD.

For few years ago the discussions with Tony Smith initiated a fourth thread which deserves the name 'TGD as a generalized number theory'. The basic observation was that classical number fields might allow a deeper formulation of quantum TGD. The work with Riemann hypothesis made time ripe for realization that the notion of infinite primes could provide, not only a reformulation, but a deep generalization of quantum TGD. This led to a thorough and extremely fruitful revision of the basic views about what the final form and physical content of quantum TGD might be. Together with the vision about the fusion of p-adic and real physics to a larger coherent structure these sub-threads fused to the "physics as generalized number theory" th

A further thread emerged from the realization that by quantum classical correspondence TGD predicts an infinite hierarchy of macroscopic quantum systems with increasing sizes, that it is not at all clear whether standard quantum mechanics can accommodate this hierarchy, and that a dynamical quantized Planck constant might be necessary and certainly possible in TGD framework. The identification of hierarchy of Planck constants whose values TGD "predicts" in terms of dark matter hierarchy would be natural. This also led to a solution of a long standing puzzle: what is the proper interpretation of the predicted fractal hierarchy of long ranged classical electro-weak and color gauge fields. Quantum classical correspondences allows only single answer: there is infinite hierarchy of p-adically scaled up variants of standard model physics and for each of them also dark hierarchy. Thus TGD Universe would be fractal in very abstract and deep sense.

Every updating of the books makes me frustrated as I see how badly the structure of the representation reflects my bird's eye of view as it is at the moment of updating. At this time I realized that the chronology based identification of the threads is quite natural but not logical and it is much more logical to see p-adic physics, the ideas related to classical number fields, and infinite primes as sub-threads of a thread which might be called "physics as a generalized number theory". In the

following I adopt this view. This reduces the number of threads to four! I am not even sure about the number of threads! Be patient!

TGD forces the generalization of physics to a quantum theory of consciousness, and represent TGD as a generalized number theory vision leads naturally to the emergence of p-adic physics as physics of cognitive representations. The seven online books [K80, K60, K48, K45, K61, K70, K68] about TGD and eight online books about TGD inspired theory of consciousness and of quantum biology [K74, K12, K53, K10, K29, K36, K40, K67] are warmly recommended to the interested reader.

### 1.1.2 TGD as a Poincare invariant theory of gravitation

The first approach was born as an attempt to construct a Poincare invariant theory of gravitation. Space-time, rather than being an abstract manifold endowed with a pseudo-Riemannian structure, is regarded as a surface in the 8-dimensional space  $H = M^4 \times CP_2$ , where  $M^4$  denotes Minkowski space and  $CP_2 = SU(3)/U(2)$  is the complex projective space of two complex dimensions [A13, A5, A10, A4].

The identification of the space-time as a submanifold [A3, A12] of  $M^4 \times CP_2$  leads to an exact Poincare invariance and solves the conceptual difficulties related to the definition of the energy-momentum in General Relativity.

It soon however turned out that submanifold geometry, being considerably richer in structure than the abstract manifold geometry, leads to a geometrization of all basic interactions. First, the geometrization of the elementary particle quantum numbers is achieved. The geometry of  $CP_2$  explains electro-weak and color quantum numbers. The different H-chiralities of  $H$ -spinors correspond to the conserved baryon and lepton numbers. Secondly, the geometrization of the field concept results. The projections of the  $CP_2$  spinor connection, Killing vector fields of  $CP_2$  and of  $H$ -metric to four-surface define classical electro-weak, color gauge fields and metric in  $X^4$ .

### 1.1.3 TGD as a generalization of the hadronic string model

The second approach was based on the generalization of the mesonic string model describing mesons as strings with quarks attached to the ends of the string. In the 3-dimensional generalization 3-surfaces correspond to free particles and the boundaries of the 3- surface correspond to partons in the sense that the quantum numbers of the elementary particles reside on the boundaries. Various boundary topologies (number of handles) correspond to various fermion families so that one obtains an explanation for the known elementary particle quantum numbers. This approach leads also to a natural topological description of the particle reactions as topology changes: for instance, two-particle decay corresponds to a decay of a 3-surface to two disjoint 3-surfaces.

This decay vertex does not however correspond to a direct generalization of trouser vertex of string models. Indeed, the important difference between TGD and string models is that the analogs of string world sheet diagrams do not describe particle decays but the propagation of particles via different routes. Particle reactions are described by generalized Feynman diagrams for which 3-D light-like surface describing particle propagating join along their ends at vertices. As 4-manifolds the space-time surfaces are therefore singular like Feynman diagrams as 1-manifolds.

### 1.1.4 Fusion of the two approaches via a generalization of the space-time concept

The problem is that the two approaches to TGD seem to be mutually exclusive since the orbit of a particle like 3-surface defines 4-dimensional surface, which differs drastically from the topologically trivial macroscopic space-time of General Relativity. The unification of these approaches forces a considerable generalization of the conventional space-time concept. First, the topologically trivial 3-space of General Relativity is replaced with a "topological condensate" containing matter as particle like 3-surfaces "glued" to the topologically trivial background 3-space by connected sum operation. Secondly, the assumption about connectedness of the 3-space is given up. Besides the "topological condensate" there could be "vapor phase" that is a "gas" of particle like 3-surfaces (counterpart of the "baby universes" of GRT) and the nonconservation of energy in GRT corresponds to the transfer of energy between the topological condensate and vapor phase.

What one obtains is what I have christened as many-sheeted space-time. One particular aspect is topological field quantization meaning that various classical fields assignable to a physical system

correspond to space-time sheets representing the classical fields to that particular system. One can speak of the field body of a particular physical system. Field body consists of topological light rays, and electric and magnetic flux quanta. In Maxwell's theory system does not possess this kind of field identity. The notion of magnetic body is one of the key players in TGD inspired theory of consciousness and quantum biology.

This picture became more detailed with the advent of zero energy ontology (ZEO). The basic notion of ZEO is causal diamond ( $CD$ ) identified as the Cartesian product of  $CP_2$  and of the intersection of future and past directed light-cones and having scale coming as an integer multiple of  $CP_2$  size is fundamental.  $CD$ s form a fractal hierarchy and zero energy states decompose to products of positive and negative energy parts assignable to the opposite boundaries of  $CD$  defining the ends of the space-time surface. The counterpart of zero energy state in positive energy ontology is in terms of initial and final states of a physical event, say particle reaction.

General Coordinate Invariance allows to identify the basic dynamical objects as space-like 3-surfaces at the ends of space-time surface at boundaries of  $CD$ : this means that space-time surface is analogous to Bohr orbit. An alternative identification is as light-like 3-surfaces at which the signature of the induced metric changes from Minkowskian to Euclidian and interpreted as lines of generalized Feynman diagrams. Also the Euclidian 4-D regions would have similar interpretation. The requirement that the two interpretations are equivalent, leads to a strong form of General Coordinate Invariance. The outcome is effective 2-dimensionality stating that the partonic 2-surfaces identified as intersections of the space-like ends of space-time surface and light-like wormhole throats are the fundamental objects. That only effective 2-dimensionality is in question is due to the effects caused by the failure of strict determinism of Kähler action. In finite length scale resolution these effects can be neglected below UV cutoff and above IR cutoff. One can also speak about strong form of holography.

There is a further generalization of the space-time concept inspired by p-adic physics forcing a generalization of the number concept through the fusion of real numbers and various p-adic number fields. Also the hierarchy of Planck constants forces a generalization of the notion of space-time.

A very concise manner to express how TGD differs from Special and General Relativities could be following. Relativity Principle (Poincare Invariance), General Coordinate Invariance, and Equivalence Principle remain true. What is new is the notion of sub-manifold geometry: this allows to realize Poincare Invariance and geometrize gravitation simultaneously. This notion also allows a geometrization of known fundamental interactions and is an essential element of all applications of TGD ranging from Planck length to cosmological scales. Sub-manifold geometry is also crucial in the applications of TGD to biology and consciousness theory.

The worst objection against TGD is the observation that all classical gauge fields are expressible in terms of four imbedding space coordinates only- essentially  $CP_2$  coordinates. The linear superposition of classical gauge fields taking place independently for all gauge fields is lost. This would be a catastrophe without many-sheeted space-time. Instead of gauge fields, only the effects such as gauge forces are superposed. Particle topologically condenses to several space-time sheets simultaneously and experiences the sum of gauge forces. This transforms the weakness to extreme economy: in a typical unified theory the number of primary field variables is countered in hundreds if not thousands, now it is just four.

## 1.2 The threads in the development of quantum TGD

The development of TGD has involved several strongly interacting threads: physics as infinite-dimensional geometry; TGD as a generalized number theory, the hierarchy of Planck constants interpreted in terms of dark matter hierarchy, and TGD inspired theory of consciousness. In the following these threads are briefly described.

### 1.2.1 Quantum TGD as spinor geometry of World of Classical Worlds

A turning point in the attempts to formulate a mathematical theory was reached after seven years from the birth of TGD. The great insight was "Do not quantize". The basic ingredients to the new approach have served as the basic philosophy for the attempt to construct Quantum TGD since then and have been the following ones:

1. Quantum theory for extended particles is free(!), classical(!) field theory for a generalized Schrödinger amplitude in the configuration space  $CH$  consisting of all possible 3-surfaces in  $H$ . "All possible" means that surfaces with arbitrary many disjoint components and with arbitrary internal topology and also singular surfaces topologically intermediate between two different manifold topologies are included. Particle reactions are identified as topology changes [A8, A14, A15]. For instance, the decay of a 3-surface to two 3-surfaces corresponds to the decay  $A \rightarrow B + C$ . Classically this corresponds to a path of configuration space leading from 1-particle sector to 2-particle sector. At quantum level this corresponds to the dispersion of the generalized Schrödinger amplitude localized to 1-particle sector to two-particle sector. All coupling constants should result as predictions of the theory since no nonlinearities are introduced.
2. During years this naive and very rough vision has of course developed a lot and is not anymore quite equivalent with the original insight. In particular, the space-time correlates of Feynman graphs have emerged from theory as Euclidian space-time regions and the strong form of General Coordinate Invariance has led to a rather detailed and in many respects un-expected visions. This picture forces to give up the idea about smooth space-time surfaces and replace space-time surface with a generalization of Feynman diagram in which vertices represent the failure of manifold property. I have also started introduced the word "world of classical worlds" (WCW) instead of rather formal "configuration space". I hope that "WCW" does not induce despair in the reader having tendency to think about the technicalities involved!
3. WCW is endowed with metric and spinor structure so that one can define various metric related differential operators, say Dirac operator, appearing in the field equations of the theory. The most ambitious dream is that zero energy states correspond to a complete solution basis for the Dirac operator of WCW so that this classical free field theory would dictate M-matrices which form orthonormal rows of what I call U-matrix. Given M-matrix in turn would decompose to a product of a hermitian density matrix and unitary S-matrix.

M-matrix would define time-like entanglement coefficients between positive and negative energy parts of zero energy states (all net quantum numbers vanish for them) and can be regarded as a hermitian square root of density matrix multiplied by a unitary S-matrix. Quantum theory would be in well-defined sense a square root of thermodynamics. The orthogonality and hermiticity of the complex square roots of density matrices commuting with S-matrix means that they span infinite-dimensional Lie algebra acting as symmetries of the S-matrix. Therefore quantum TGD would reduce to group theory in well-defined sense: its own symmetries would define the symmetries of the theory. In fact the Lie algebra of Hermitian M-matrices extends to Kac-Moody type algebra obtained by multiplying hermitian square roots of density matrices with powers of the S-matrix. Also the analog of Yangian algebra involving only non-negative powers of S-matrix is possible.

4. By quantum classical correspondence the construction of WCW spinor structure reduces to the second quantization of the induced spinor fields at space-time surface. The basic action is so called modified Dirac action in which gamma matrices are replaced with the modified gamma matrices defined as contractions of the canonical momentum currents with the imbedding space gamma matrices. In this manner one achieves super-conformal symmetry and conservation of fermionic currents among other things and consistent Dirac equation. This modified gamma matrices define as anticommutators effective metric, which might provide geometrization for some basic observables of condensed matter physics. The conjecture is that Dirac determinant for the modified Dirac action gives the exponent of Kähler action for a preferred extremal as vacuum functional so that one might talk about bosonic emergence in accordance with the prediction that the gauge bosons and graviton are expressible in terms of bound states of fermion and antifermion.

The evolution of these basic ideas has been rather slow but has gradually led to a rather beautiful vision. One of the key problems has been the definition of Kähler function. Kähler function is Kähler action for a preferred extremal assignable to a given 3-surface but what this preferred extremal is? The obvious first guess was as absolute minimum of Kähler action but could not be proven to be right or wrong. One big step in the progress was boosted by the idea that TGD should reduce to almost topological QFT in which braids would replace 3-surfaces in finite measurement resolution, which could

be inherent property of the theory itself and imply discretization at partonic 2-surfaces with discrete points carrying fermion number.

1. TGD as almost topological QFT vision suggests that Kähler action for preferred extremals reduces to Chern-Simons term assigned with space-like 3-surfaces at the ends of space-time (recall the notion of causal diamond ( $CD$ )) and with the light-like 3-surfaces at which the signature of the induced metric changes from Minkowskian to Euclidian. Minkowskian and Euclidian regions would give at wormhole throats the same contribution apart from coefficients and in Minkowskian regions the  $\sqrt{g_4}$  factor would be imaginary so that one would obtain sum of real term identifiable as Kähler function and imaginary term identifiable as the ordinary action giving rise to interference effects and stationary phase approximation central in both classical and quantum field theory. Imaginary contribution - the presence of which I realized only after 33 years of TGD - could also have topological interpretation as a Morse function. On physical side the emergence of Euclidian space-time regions is something completely new and leads to a dramatic modification of the ideas about black hole interior.
2. The manner to achieve the reduction to Chern-Simons terms is simple. The vanishing of Coulombic contribution to Kähler action is required and is true for all known extremals if one makes a general ansatz about the form of classical conserved currents. The so called weak form of electric-magnetic duality defines a boundary condition reducing the resulting 3-D terms to Chern-Simons terms. In this manner almost topological QFT results. But only "almost" since the Lagrange multiplier term forcing electric-magnetic duality implies that Chern-Simons action for preferred extremals depends on metric.
3. A further quite recent hypothesis inspired by effective 2-dimensionality is that Chern-Simons terms reduce to a sum of two 2-dimensional terms. An imaginary term proportional to the total area of Minkowskian string world sheets and a real term proportional to the total area of partonic 2-surfaces or equivalently strings world sheets in Euclidian space-time regions. Also the equality of the total areas of strings world sheets and partonic 2-surfaces is highly suggestive and would realize a duality between these two kinds of objects. String world sheets indeed emerge naturally for the proposed ansatz defining preferred extremals. Therefore Kähler action would have very stringy character apart from effects due to the failure of the strict determinism meaning that radiative corrections break the effective 2-dimensionality.

### 1.2.2 TGD as a generalized number theory

Quantum T(opological)D(ynamics) as a classical spinor geometry for infinite-dimensional configuration space, p-adic numbers and quantum TGD, and TGD inspired theory of consciousness, have been for last ten years the basic three strongly interacting threads in the tapestry of quantum TGD. The fourth thread deserves the name 'TGD as a generalized number theory'. It involves three separate threads: the fusion of real and various p-adic physics to a single coherent whole by requiring number theoretic universality discussed already, the formulation of quantum TGD in terms of hyper-counterparts of classical number fields identified as sub-spaces of complexified classical number fields with Minkowskian signature of the metric defined by the complexified inner product, and the notion of infinite prime.

#### p-Adic TGD and fusion of real and p-adic physics to single coherent whole

The p-adic thread emerged for roughly ten years ago as a dim hunch that p-adic numbers might be important for TGD. Experimentation with p-adic numbers led to the notion of canonical identification mapping reals to p-adics and vice versa. The breakthrough came with the successful p-adic mass calculations using p-adic thermodynamics for Super-Virasoro representations with the super-Kac-Moody algebra associated with a Lie-group containing standard model gauge group. Although the details of the calculations have varied from year to year, it was clear that p-adic physics reduces not only the ratio of proton and Planck mass, the great mystery number of physics, but all elementary particle mass scales, to number theory if one assumes that primes near prime powers of two are in a physically favored position. Why this is the case, became one of the key puzzles and led to a number

of arguments with a common gist: evolution is present already at the elementary particle level and the primes allowed by the p-adic length scale hypothesis are the fittest ones.

It became very soon clear that p-adic topology is not something emerging in Planck length scale as often believed, but that there is an infinite hierarchy of p-adic physics characterized by p-adic length scales varying to even cosmological length scales. The idea about the connection of p-adics with cognition motivated already the first attempts to understand the role of the p-adics and inspired 'Universe as Computer' vision but time was not ripe to develop this idea to anything concrete (p-adic numbers are however in a central role in TGD inspired theory of consciousness). It became however obvious that the p-adic length scale hierarchy somehow corresponds to a hierarchy of intelligences and that p-adic prime serves as a kind of intelligence quotient. Ironically, the almost obvious idea about p-adic regions as cognitive regions of space-time providing cognitive representations for real regions had to wait for almost a decade for the access into my consciousness.

There were many interpretational and technical questions crying for a definite answer.

1. What is the relationship of p-adic non-determinism to the classical non-determinism of the basic field equations of TGD? Are the p-adic space-time region genuinely p-adic or does p-adic topology only serve as an effective topology? If p-adic physics is direct image of real physics, how the mapping relating them is constructed so that it respects various symmetries? Is the basic physics p-adic or real (also real TGD seems to be free of divergences) or both? If it is both, how should one glue the physics in different number field together to get *The Physics*? Should one perform p-adicization also at the level of the configuration space of 3-surfaces? Certainly the p-adicization at the level of super-conformal representation is necessary for the p-adic mass calculations.
2. Perhaps the most basic and most irritating technical problem was how to precisely define p-adic definite integral which is a crucial element of any variational principle based formulation of the field equations. Here the frustration was not due to the lack of solution but due to the too large number of solutions to the problem, a clear symptom for the sad fact that clever inventions rather than real discoveries might be in question. Quite recently I however learned that the problem of making sense about p-adic integration has been for decades central problem in the frontier of mathematics and a lot of profound work has been done along same intuitive lines as I have proceeded in TGD framework. The basic idea is certainly the notion of algebraic continuation from the world of rationals belonging to the intersection of real world and various p-adic worlds.

Despite these frustrating uncertainties, the number of the applications of the poorly defined p-adic physics grew steadily and the applications turned out to be relatively stable so that it was clear that the solution to these problems must exist. It became only gradually clear that the solution of the problems might require going down to a deeper level than that represented by reals and p-adics.

The key challenge is to fuse various p-adic physics and real physics to single larger structures. This has inspired a proposal for a generalization of the notion of number field by fusing real numbers and various p-adic number fields and their extensions along rationals and possible common algebraic numbers. This leads to a generalization of the notions of imbedding space and space-time concept and one can speak about real and p-adic space-time sheets. The quantum dynamics should be such that it allows quantum transitions transforming space-time sheets belonging to different number fields to each other. The space-time sheets in the intersection of real and p-adic worlds are of special interest and the hypothesis is that living matter resides in this intersection. This leads to surprisingly detailed predictions and far reaching conjectures. For instance, the number theoretic generalization of entropy concept allows negentropic entanglement central for the applications to living matter.

The basic principle is number theoretic universality stating roughly that the physics in various number fields can be obtained as completion of rational number based physics to various number fields. Rational number based physics would in turn describe physics in finite measurement resolution and cognitive resolution. The notion of finite measurement resolution has become one of the basic principles of quantum TGD and leads to the notions of braids as representatives of 3-surfaces and inclusions of hyper-finite factors as a representation for finite measurement resolution.

### The role of classical number fields

The vision about the physical role of the classical number fields relies on the notion of number theoretic compactification stating that space-time surfaces can be regarded as surfaces of either  $M^8$  or  $M^4 \times CP_2$ . As surfaces of  $M^8$  identifiable as space of hyper-octonions they are hyper-quaternionic or co-hyper-quaternionic- and thus maximally associative or co-associative. This means that their tangent space is either hyper-quaternionic plane of  $M^8$  or an orthogonal complement of such a plane. These surface can be mapped in natural manner to surfaces in  $M^4 \times CP_2$  [K72] provided one can assign to each point of tangent space a hyper-complex plane  $M^2(x) \subset M^4$ . One can also speak about  $M^8 - H$  duality.

This vision has very strong predictive power. It predicts that the extremals of Kähler action correspond to either hyper-quaternionic or co-hyper-quaternionic surfaces such that one can assign to tangent space at each point of space-time surface a hyper-complex plane  $M^2(x) \subset M^4$ . As a consequence, the  $M^4$  projection of space-time surface at each point contains  $M^2(x)$  and its orthogonal complement. These distributions are integrable implying that space-time surface allows dual slicings defined by string world sheets  $Y^2$  and partonic 2-surfaces  $X^2$ . The existence of this kind of slicing was earlier deduced from the study of extremals of Kähler action and christened as Hamilton-Jacobi structure. The physical interpretation of  $M^2(x)$  is as the space of non-physical polarizations and the plane of local 4-momentum.

One can fairly say, that number theoretical compactification is responsible for most of the understanding of quantum TGD that has emerged during last years. This includes the realization of Equivalence Principle at space-time level, dual formulations of TGD as Minkowskian and Euclidian string model type theories, the precise identification of preferred extremals of Kähler action as extremals for which second variation vanishes (at least for deformations representing dynamical symmetries) and thus providing space-time correlate for quantum criticality, the notion of number theoretic braid implied by the basic dynamics of Kähler action and crucial for precise construction of quantum TGD as almost-topological QFT, the construction of configuration space metric and spinor structure in terms of second quantized induced spinor fields with modified Dirac action defined by Kähler action realizing automatically the notion of finite measurement resolution and a connection with inclusions of hyper-finite factors of type  $II_1$  about which Clifford algebra of configuration space represents an example.

The two most important number theoretic conjectures relate to the preferred extremals of Kähler action. The general idea is that classical dynamics for the preferred extremals of Kähler action should reduce to number theory: space-time surfaces should be either associative or co-associative in some sense.

1. The first meaning for associativity (co-associativity) would be that tangent (normal) spaces of space-time surfaces are quaternionic in some sense and thus associative. This can be formulated in terms of octonionic representation of the imbedding space gamma matrices possible in dimension  $D = 8$  and states that induced gamma matrices generate quaternionic sub-algebra at each space-time point. It seems that induced rather than modified gamma matrices must be in question.
2. Second meaning for associative (co-associativity) would be following. In the case of complex numbers the vanishing of the real part of real-analytic function defines a 1-D curve. In octonionic case one can decompose octonion to sum of quaternion and quaternion multiplied by an octonionic imaginary unit. Quaternionicity could mean that space-time surfaces correspond to the vanishing of the imaginary part of the octonion real-analytic function. Co-quaternionicity would be defined in an obvious manner. Octonionic real analytic functions form a function field closed also with respect to the composition of functions. Space-time surfaces would form the analog of function field with the composition of functions with all operations realized as algebraic operations for space-time surfaces. Co-associativity could be perhaps seen as an additional feature making the algebra in question also co-algebra.
3. The third conjecture is that these conjectures are equivalent.

### Infinite primes

The discovery of the hierarchy of infinite primes and their correspondence with a hierarchy defined by a repeatedly second quantized arithmetic quantum field theory gave a further boost for the speculations

about TGD as a generalized number theory. The work with Riemann hypothesis led to further ideas.

After the realization that infinite primes can be mapped to polynomials representable as surfaces geometrically, it was clear how TGD might be formulated as a generalized number theory with infinite primes forming the bridge between classical and quantum such that real numbers, p-adic numbers, and various generalizations of p-adics emerge dynamically from algebraic physics as various completions of the algebraic extensions of rational (hyper-)quaternions and (hyper-)octonions. Complete algebraic, topological and dimensional democracy would characterize the theory.

What is especially satisfying is that p-adic and real regions of the space-time surface could emerge automatically as solutions of the field equations. In the space-time regions where the solutions of field equations give rise to in-admissible complex values of the imbedding space coordinates, p-adic solution can exist for some values of the p-adic prime. The characteristic non-determinism of the p-adic differential equations suggests strongly that p-adic regions correspond to 'mind stuff', the regions of space-time where cognitive representations reside. This interpretation implies that p-adic physics is physics of cognition. Since Nature is probably an extremely brilliant simulator of Nature, the natural idea is to study the p-adic physics of the cognitive representations to derive information about the real physics. This view encouraged by TGD inspired theory of consciousness clarifies difficult interpretational issues and provides a clear interpretation for the predictions of p-adic physics.

### 1.2.3 Hierarchy of Planck constants and dark matter hierarchy

By quantum classical correspondence space-time sheets can be identified as quantum coherence regions. Hence the fact that they have all possible size scales more or less unavoidably implies that Planck constant must be quantized and have arbitrarily large values. If one accepts this then also the idea about dark matter as a macroscopic quantum phase characterized by an arbitrarily large value of Planck constant emerges naturally as does also the interpretation for the long ranged classical electro-weak and color fields predicted by TGD. Rather seldom the evolution of ideas follows simple linear logic, and this was the case also now. In any case, this vision represents the fifth, relatively new thread in the evolution of TGD and the ideas involved are still evolving.

#### Dark matter as large $\hbar$ phase

D. Da Rocha and Laurent Nottale [E23] have proposed that Schrödinger equation with Planck constant  $\hbar$  replaced with what might be called gravitational Planck constant  $\hbar_{gr} = \frac{GmM}{v_0}$  ( $\hbar = c = 1$ ).  $v_0$  is a velocity parameter having the value  $v_0 = 144.7 \pm .7$  km/s giving  $v_0/c = 4.6 \times 10^{-4}$ . This is rather near to the peak orbital velocity of stars in galactic halos. Also subharmonics and harmonics of  $v_0$  seem to appear. The support for the hypothesis coming from empirical data is impressive.

Nottale and Da Rocha believe that their Schrödinger equation results from a fractal hydrodynamics. Many-sheeted space-time however suggests astrophysical systems are not only quantum systems at larger space-time sheets but correspond to a gigantic value of gravitational Planck constant. The gravitational (ordinary) Schrödinger equation would provide a solution of the black hole collapse (IR catastrophe) problem encountered at the classical level. The resolution of the problem inspired by TGD inspired theory of living matter is that it is the dark matter at larger space-time sheets which is quantum coherent in the required time scale [K65].

TGD predicts correctly the value of the parameter  $v_0$  assuming that cosmic strings and their decay remnants are responsible for the dark matter. The harmonics of  $v_0$  can be understood as corresponding to perturbations replacing cosmic strings with their n-branched coverings so that tension becomes  $n^2$ -fold: much like the replacement of a closed orbit with an orbit closing only after  $n$  turns.  $1/n$ -sub-harmonic would result when a magnetic flux tube split into  $n$  disjoint magnetic flux tubes. Also a model for the formation of planetary system as a condensation of ordinary matter around quantum coherent dark matter emerges [K65].

The values of Planck constants postulated by Nottale are gigantic and it is natural to assign them to the space-time sheets mediating gravitational interaction and identifiable as magnetic flux tubes (quanta). The magnetic energy of these flux quanta would correspond to dark energy and magnetic tension would give rise to negative "pressure" forcing accelerate cosmological expansion. This leads to a rather detailed vision about the evolution of stars and galaxies identified as bubbles of ordinary and dark matter inside magnetic flux tubes identifiable as dark energy.



### Hierarchy of Planck constants from the anomalies of neuroscience biology

The quantal effects of ELF em fields on vertebrate brain have been known since seventies. ELF em fields at frequencies identifiable as cyclotron frequencies in magnetic field whose intensity is about 2/5 times that of Earth for biologically important ions have physiological effects and affect also behavior. What is intriguing that the effects are found only in vertebrates (to my best knowledge). The energies for the photons of ELF em fields are extremely low - about  $10^{-10}$  times lower than thermal energy at physiological temperatures- so that quantal effects are impossible in the framework of standard quantum theory. The values of Planck constant would be in these situations large but not gigantic.

This inspired the hypothesis that these photons correspond to so large value of Planck constant that the energy of photons is above the thermal energy. The proposed interpretation was as dark photons and the general hypothesis was that dark matter corresponds to ordinary matter with non-standard value of Planck constant. If only particles with the same value of Planck constant can appear in the same vertex of Feynman diagram, the phases with different value of Planck constant are dark relative to each other. The phase transitions changing Planck constant can however make possible interactions between phases with different Planck constant but these interactions do not manifest themselves in particle physics. Also the interactions mediated by classical fields should be possible. Dark matter would not be so dark as we have used to believe.

Also the anomalies of biology support the view that dark matter might be a key player in living matter.

### Does the hierarchy of Planck constants reduce to the vacuum degeneracy of Kähler action?

This starting point led gradually to the recent picture in which the hierarchy of Planck constants is postulated to come as integer multiples of the standard value of Planck constant. Given integer multiple  $\hbar = n\hbar_0$  of the ordinary Planck constant  $\hbar_0$  is assigned with a multiple singular covering of the imbedding space [K25]. One ends up to an identification of dark matter as phases with non-standard value of Planck constant having geometric interpretation in terms of these coverings providing generalized imbedding space with a book like structure with pages labelled by Planck constants or integers characterizing Planck constant. The phase transitions changing the value of Planck constant would correspond to leakage between different sectors of the extended imbedding space. The question is whether these coverings must be postulated separately or whether they are only a convenient auxiliary tool.

The simplest option is that the hierarchy of coverings of imbedding space is only effective. Many-sheeted coverings of the imbedding space indeed emerge naturally in TGD framework. The huge vacuum degeneracy of Kähler action implies that the relationship between gradients of the imbedding space coordinates and canonical momentum currents is many-to-one: this was the very fact forcing to give up all the standard quantization recipes and leading to the idea about physics as geometry of the "world of classical worlds". If one allows space-time surfaces for which all sheets corresponding to the same values of the canonical momentum currents are present, one obtains effectively many-sheeted covering of the imbedding space and the contributions from sheets to the Kähler action are identical. If all sheets are treated effectively as one and the same sheet, the value of Planck constant is an integer multiple of the ordinary one. A natural boundary condition would be that at the ends of space-time at future and past boundaries of causal diamond containing the space-time surface, various branches co-incide. This would raise the ends of space-time surface in special physical role.

### Dark matter as a source of long ranged weak and color fields

Long ranged classical electro-weak and color gauge fields are unavoidable in TGD framework. The smallness of the parity breaking effects in hadronic, nuclear, and atomic length scales does not however seem to allow long ranged electro-weak gauge fields. The problem disappears if long range classical electro-weak gauge fields are identified as space-time correlates for massless gauge fields created by dark matter. Also scaled up variants of ordinary electro-weak particle spectra are possible. The identification explains chiral selection in living matter and unbroken  $U(2)_{ew}$  invariance and free color in bio length scales become characteristics of living matter and of bio-chemistry and bio-nuclear physics. A possible solution of the matter antimatter asymmetry is based on the identification of also antimatter as dark matter.

### 1.2.4 TGD as a generalization of physics to a theory consciousness

General coordinate invariance forces the identification of quantum jump as quantum jump between entire deterministic quantum histories rather than time=constant snapshots of single history. The new view about quantum jump forces a generalization of quantum measurement theory such that observer becomes part of the physical system. Thus a general theory of consciousness is unavoidable outcome. This theory is developed in detail in the books [K74, K12, K53, K10, K29, K36, K40, K67].

#### Quantum jump as a moment of consciousness

The identification of quantum jump between deterministic quantum histories (configuration space spinor fields) as a moment of consciousness defines microscopic theory of consciousness. Quantum jump involves the steps

$$\Psi_i \rightarrow U\Psi_i \rightarrow \Psi_f ,$$

where  $U$  is informational "time development" operator, which is unitary like the S-matrix characterizing the unitary time evolution of quantum mechanics.  $U$  is however only formally analogous to Schrödinger time evolution of infinite duration although there is *no* real time evolution involved. It is not however clear whether one should regard U-matrix and S-matrix as two different things or not:  $U$ -matrix is a completely universal object characterizing the dynamics of evolution by self-organization whereas S-matrix is a highly context dependent concept in wave mechanics and in quantum field theories where it at least formally represents unitary time translation operator at the limit of an infinitely long interaction time. The S-matrix understood in the spirit of superstring models is however something very different and could correspond to U-matrix.

The requirement that quantum jump corresponds to a measurement in the sense of quantum field theories implies that each quantum jump involves localization in zero modes which parameterize also the possible choices of the quantization axes. Thus the selection of the quantization axes performed by the Cartesian outsider becomes now a part of quantum theory. Together these requirements imply that the final states of quantum jump correspond to quantum superpositions of space-time surfaces which are macroscopically equivalent. Hence the world of conscious experience looks classical. At least formally quantum jump can be interpreted also as a quantum computation in which matrix  $U$  represents unitary quantum computation which is however not identifiable as unitary translation in time direction and cannot be 'engineered'.

Can one say anything about the unitary process? Zero energy states correspond in positive energy ontology to physical events and break time reversal invariance. This because either the positive or negative energy part of the state is prepared whereas the second end of  $CD$  corresponds to a superposition of (negative/positive energy) states with varying particle numbers and single particle quantum numbers just as in ordinary particle physics experiment. State function reduction must change the roles of the ends of  $CD$ s. Therefore  $U$ -matrix should correspond to the unitary matrix relating zero energy state basis prepared at different ends of  $CD$  and state function reduction would be equivalent with state preparation.

The basic objection is that the arrow of geometric time alternates at imbedding space level but we know that arrow of time is universal. What one can say about the arrow of time at space-time level? Quantum classical correspondence requires that quantum mechanical irreversibility corresponds to irreversibility at space-time level. If the observer is analogous to an inhabitant of Flatland gaining information only about space-time surface, he or she is not able to discover that the arrow of time alternates at the level of imbedding space. The inhabitant of a folded bath towel is not able to observe the folding of the towel! Only by observing systems for which the imbedding space arrow of time is opposite, observer can discover the alternation. Living systems indeed behave as if they would contain space-time sheets with opposite arrow of geometric time (self-organization). Phase conjugate light beam is second example of this.

#### The notion of self

The concept of self is absolutely essential for the understanding of the macroscopic and macro-temporal aspects of consciousness. Self corresponds to a subsystem able to remain un-entangled under the

sequential informational 'time evolutions'  $U$ . Exactly vanishing entanglement is practically impossible in ordinary quantum mechanics and it might be that 'vanishing entanglement' in the condition for self-property should be replaced with 'subcritical entanglement'. On the other hand, if space-time decomposes into p-adic and real regions, and if entanglement between regions representing physics in different number fields vanishes, space-time indeed decomposes into selves in a natural manner.

It is assumed that the experiences of the self after the last 'wake-up' sum up to single average experience. This means that subjective memory is identifiable as conscious, immediate short term memory. Selves form an infinite hierarchy with the entire Universe at the top. Self can be also interpreted as mental images: our mental images are selves having mental images and also we represent mental images of a higher level self. A natural hypothesis is that self  $S$  experiences the experiences of its subselves as kind of abstracted experience: the experiences of subselves  $S_i$  are not experienced as such but represent kind of averages  $\langle S_{ij} \rangle$  of sub-subselves  $S_{ij}$ . Entanglement between selves, most naturally realized by the formation of join along boundaries bonds between cognitive or material space-time sheets, provides a possible a mechanism for the fusion of selves to larger selves (for instance, the fusion of the mental images representing separate right and left visual fields to single visual field) and forms wholes from parts at the level of mental images.

An attractive possibility suggested by zero energy ontology is that the notions of self and quantum jump reduce to each other and that a fractal hierarchy of quantum jumps within quantum jumps is enough.  $CD$ s would serve as imbedding space correlates of selves and quantum jumps would be followed by cascades of state function reductions beginning from given  $CD$  and proceeding downwards to the smaller scales (smaller  $CD$ s). State function reduction cascades could also take place in parallel branches of the quantum state. One ends up with concrete ideas about how the arrow of geometric time is induced from that of subjective time defined by the experiences induced by the sequences of quantum jumps for sub-selves of self. One ends also ends up with concrete ideas about how the localization of the contents of sensory experience and cognition to the upper boundaries of  $CD$  could take place.

### Relationship to quantum measurement theory

The third basic element relates TGD inspired theory of consciousness to quantum measurement theory. The assumption that localization occurs in zero modes in each quantum jump implies that the world of conscious experience looks classical. It also implies the state function reduction of the standard quantum measurement theory as the following arguments demonstrate (it took incredibly long time to realize this almost obvious fact!).

1. The standard quantum measurement theory a la von Neumann involves the interaction of brain with the measurement apparatus. If this interaction corresponds to entanglement between microscopic degrees of freedom  $m$  with the macroscopic effectively classical degrees of freedom  $M$  characterizing the reading of the measurement apparatus coded to brain state, then the reduction of this entanglement in quantum jump reproduces standard quantum measurement theory provide the unitary time evolution operator  $U$  acts as flow in zero mode degrees of freedom and correlates completely some orthonormal basis of configuration space spinor fields in non-zero modes with the values of the zero modes. The flow property guarantees that the localization is consistent with unitarity: it also means 1-1 mapping of quantum state basis to classical variables (say, spin direction of the electron to its orbit in the external magnetic field).
2. Since zero modes represent classical information about the geometry of space-time surface (shape, size, classical Kähler field,...), they have interpretation as effectively classical degrees of freedom and are the TGD counterpart of the degrees of freedom  $M$  representing the reading of the measurement apparatus. The entanglement between quantum fluctuating non-zero modes and zero modes is the TGD counterpart for the  $m - M$  entanglement. Therefore the localization in zero modes is equivalent with a quantum jump leading to a final state where the measurement apparatus gives a definite reading.

This simple prediction is of utmost theoretical importance since the black box of the quantum measurement theory is reduced to a fundamental quantum theory. This reduction is implied by the replacement of the notion of a point like particle with particle as a 3-surface. Also the infinite-dimensionality of the zero mode sector of the configuration space of 3-surfaces is absolutely essential. Therefore the reduction is a triumph for quantum TGD and favors TGD against string models.

Standard quantum measurement theory involves also the notion of state preparation which reduces to the notion of self measurement. Each localization in zero modes is followed by a cascade of self measurements leading to a product state. This process is obviously equivalent with the state preparation process. Self measurement is governed by the so called Negentropy Maximization Principle (NMP) stating that the information content of conscious experience is maximized. In the self measurement the density matrix of some subsystem of a given self localized in zero modes (after ordinary quantum measurement) is measured. The self measurement takes place for that subsystem of self for which the reduction of the entanglement entropy is maximal in the measurement. In p-adic context NMP can be regarded as the variational principle defining the dynamics of cognition. In real context self measurement could be seen as a repair mechanism allowing the system to fight against quantum thermalization by reducing the entanglement for the subsystem for which it is largest (fill the largest hole first in a leaking boat).

### Selves self-organize

The fourth basic element is quantum theory of self-organization based on the identification of quantum jump as the basic step of self-organization [K62]. Quantum entanglement gives rise to the generation of long range order and the emergence of longer p-adic length scales corresponds to the emergence of larger and larger coherent dynamical units and generation of a slaving hierarchy. Energy (and quantum entanglement) feed implying entropy feed is a necessary prerequisite for quantum self-organization. Zero modes represent fundamental order parameters and localization in zero modes implies that the sequence of quantum jumps can be regarded as hopping in the zero modes so that Haken's classical theory of self organization applies almost as such. Spin glass analogy is a further important element: self-organization of self leads to some characteristic pattern selected by dissipation as some valley of the "energy" landscape.

Dissipation can be regarded as the ultimate Darwinian selector of both memes and genes. The mathematically ugly irreversible dissipative dynamics obtained by adding phenomenological dissipation terms to the reversible fundamental dynamical equations derivable from an action principle can be understood as a phenomenological description replacing in a well defined sense the series of reversible quantum histories with its envelope.

### Classical non-determinism of Kähler action

The fifth basic element are the concepts of association sequence and cognitive space-time sheet. The huge vacuum degeneracy of the Kähler action suggests strongly that the absolute minimum space-time is not always unique. For instance, a sequence of bifurcations can occur so that a given space-time branch can be fixed only by selecting a finite number of 3-surfaces with time like(!) separations on the orbit of 3-surface. Quantum classical correspondence suggest an alternative formulation. Space-time surface decomposes into maximal deterministic regions and their temporal sequences have interpretation a space-time correlate for a sequence of quantum states defined by the initial (or final) states of quantum jumps. This is consistent with the fact that the variational principle selects preferred extremals of Kähler action as generalized Bohr orbits.

In the case that non-determinism is located to a finite time interval and is microscopic, this sequence of 3-surfaces has interpretation as a simulation of a classical history, a geometric correlate for contents of consciousness. When non-determinism has long lasting and macroscopic effect one can identify it as volitional non-determinism associated with our choices. Association sequences relate closely with the cognitive space-time sheets defined as space-time sheets having finite time duration and psychological time can be identified as a temporal center of mass coordinate of the cognitive space-time sheet. The gradual drift of the cognitive space-time sheets to the direction of future force by the geometry of the future light cone explains the arrow of psychological time.

### p-Adic physics as physics of cognition and intentionality

The sixth basic element adds a physical theory of cognition to this vision. TGD space-time decomposes into regions obeying real and p-adic topologies labelled by primes  $p = 2, 3, 5, \dots$ . p-Adic regions obey the same field equations as the real regions but are characterized by p-adic non-determinism since the functions having vanishing p-adic derivative are pseudo constants which are piecewise constant functions. Pseudo constants depend on a finite number of positive binary digits of arguments just like

numerical predictions of any theory always involve decimal cutoff. This means that p-adic space-time regions are obtained by gluing together regions for which integration constants are genuine constants. The natural interpretation of the p-adic regions is as cognitive representations of real physics. The freedom of imagination is due to the p-adic non-determinism. p-Adic regions perform mimicry and make possible for the Universe to form cognitive representations about itself. p-Adic physics space-time sheets serve also as correlates for intentional action.

A more precise formulation of this vision requires a generalization of the number concept obtained by fusing reals and p-adic number fields along common rationals (in the case of algebraic extensions among common algebraic numbers). This picture is discussed in [K71]. The application of this notion at the level of the imbedding space implies that imbedding space has a book like structure with various variants of the imbedding space glued together along common rationals (algebraics). The implication is that genuinely p-adic numbers (non-rationals) are strictly infinite as real numbers so that most points of p-adic space-time sheets are at real infinity, outside the cosmos, and that the projection to the real imbedding space is discrete set of rationals (algebraics). Hence cognition and intentionality are almost completely outside the real cosmos and touch it at a discrete set of points only.

This view implies also that purely local p-adic physics codes for the p-adic fractality characterizing long range real physics and provides an explanation for p-adic length scale hypothesis stating that the primes  $p \simeq 2^k$ ,  $k$  integer are especially interesting. It also explains the long range correlations and short term chaos characterizing intentional behavior and explains why the physical realizations of cognition are always discrete (say in the case of numerical computations). Furthermore, a concrete quantum model for how intentions are transformed to actions emerges.

The discrete real projections of p-adic space-time sheets serve also space-time correlate for a logical thought. It is very natural to assign to p-adic binary digits a  $p$ -valued logic but as such this kind of logic does not have any reasonable identification. p-Adic length scale hypothesis suggest that the  $p = 2^k - n$  binary digits represent a Boolean logic  $B^k$  with  $k$  elementary statements (the points of the  $k$ -element set in the set theoretic realization) with  $n$  taboos which are constrained to be identically true.

### **p-Adic and dark matter hierarchies and hierarchy of moments of consciousness**

Dark matter hierarchy assigned to a spectrum of Planck constant having arbitrarily large values brings additional elements to the TGD inspired theory of consciousness.

1. Macroscopic quantum coherence can be understood since a particle with a given mass can in principle appear as arbitrarily large scaled up copies (Compton length scales as  $\hbar$ ). The phase transition to this kind of phase implies that space-time sheets of particles overlap and this makes possible macroscopic quantum coherence.
2. The space-time sheets with large Planck constant can be in thermal equilibrium with ordinary ones without the loss of quantum coherence. For instance, the cyclotron energy scale associated with EEG turns out to be above thermal energy at room temperature for the level of dark matter hierarchy corresponding to magnetic flux quanta of the Earth's magnetic field with the size scale of Earth and a successful quantitative model for EEG results [K22].

Dark matter hierarchy leads to detailed quantitative view about quantum biology with several testable predictions [K22]. The general prediction is that Universe is a kind of inverted Mandelbrot fractal for which each bird's eye of view reveals new structures in long length and time scales representing scaled down copies of standard physics and their dark variants. These structures would correspond to higher levels in self hierarchy. This prediction is consistent with the belief that 75 per cent of matter in the universe is dark.

#### *1. Living matter and dark matter*

Living matter as ordinary matter quantum controlled by the dark matter hierarchy has turned out to be a particularly successful idea. The hypothesis has led to models for EEG predicting correctly the band structure and even individual resonance bands and also generalizing the notion of EEG [K22]. Also a generalization of the notion of genetic code emerges resolving the paradoxes related to the

standard dogma [K38, K22] . A particularly fascinating implication is the possibility to identify great leaps in evolution as phase transitions in which new higher level of dark matter emerges [K22] .

It seems safe to conclude that the dark matter hierarchy with levels labelled by the values of Planck constants explains the macroscopic and macro-temporal quantum coherence naturally. That this explanation is consistent with the explanation based on spin glass degeneracy is suggested by following observations. First, the argument supporting spin glass degeneracy as an explanation of the macro-temporal quantum coherence does not involve the value of  $\hbar$  at all. Secondly, the failure of the perturbation theory assumed to lead to the increase of Planck constant and formation of macroscopic quantum phases could be precisely due to the emergence of a large number of new degrees of freedom due to spin glass degeneracy. Thirdly, the phase transition increasing Planck constant has concrete topological interpretation in terms of many-sheeted space-time consistent with the spin glass degeneracy.

### 2. Dark matter hierarchy and the notion of self

The vision about dark matter hierarchy leads to a more refined view about self hierarchy and hierarchy of moments of consciousness [K21, K22] . The larger the value of Planck constant, the longer the subjectively experienced duration and the average geometric duration  $T(k) \propto \hbar$  of the quantum jump.

Quantum jumps form also a hierarchy with respect to p-adic and dark hierarchies and the geometric durations of quantum jumps scale like  $\hbar$ . Dark matter hierarchy suggests also a slight modification of the notion of self. Each self involves a hierarchy of dark matter levels, and one is led to ask whether the highest level in this hierarchy corresponds to single quantum jump rather than a sequence of quantum jumps. The averaging of conscious experience over quantum jumps would occur only for sub-selves at lower levels of dark matter hierarchy and these mental images would be ordered, and single moment of consciousness would be experienced as a history of events. The quantum parallel dissipation at the lower levels would give rise to the experience of flow of time. For instance, hadron as a macro-temporal quantum system in the characteristic time scale of hadron is a dissipating system at quark and gluon level corresponding to shorter p-adic time scales. One can ask whether even entire life cycle could be regarded as a single quantum jump at the highest level so that consciousness would not be completely lost even during deep sleep. This would allow to understand why we seem to know directly that this biological body of mine existed yesterday.

The fact that we can remember phone numbers with 5 to 9 digits supports the view that self corresponds at the highest dark matter level to single moment of consciousness. Self would experience the average over the sequence of moments of consciousness associated with each sub-self but there would be no averaging over the separate mental images of this kind, be their parallel or serial. These mental images correspond to sub-selves having shorter wake-up periods than self and would be experienced as being time ordered. Hence the digits in the phone number are experienced as separate mental images and ordered with respect to experienced time.

### 3. The time span of long term memories as signature for the level of dark matter hierarchy

The basic question is what time scale can one assign to the geometric duration of quantum jump measured naturally as the size scale of the space-time region about which quantum jump gives conscious information. This scale is naturally the size scale in which the non-determinism of quantum jump is localized. During years I have made several guesses about this time scales but zero energy ontology and the vision about fractal hierarchy of quantum jumps within quantum jumps leads to a unique identification.

Causal diamond as an imbedding space correlate of self defines the time scale  $\tau$  for the space-time region about which the consciousness experience is about. The temporal distances between the tips of  $CD$  as come as integer multiples of  $CP_2$  length scales and for prime multiples correspond to what I have christened as secondary p-adic time scales. A reasonable guess is that secondary p-adic time scales are selected during evolution and the primes near powers of two are especially favored. For electron, which corresponds to Mersenne prime  $M_{127} = 2^{127} - 1$  this scale corresponds to .1 seconds defining the fundamental time scale of living matter via 10 Hz biorhythm (alpha rhythm). The unexpected prediction is that all elementary particles correspond to time scales possibly relevant to living matter.

Dark matter hierarchy brings additional finesse. For the higher levels of dark matter hierarchy  $\tau$  is scaled up by  $\hbar/\hbar_0$ . One could understand evolutionary leaps as the emergence of higher levels at

the level of individual organism making possible intentionality and memory in the time scale defined  $\tau$ .

Higher levels of dark matter hierarchy provide a neat quantitative view about self hierarchy and its evolution. Various levels of dark matter hierarchy would naturally correspond to higher levels in the hierarchy of consciousness and the typical duration of life cycle would give an idea about the level in question. The level would determine also the time span of long term memories as discussed in [K22]. The emergence of these levels must have meant evolutionary leap since long term memory is also accompanied by ability to anticipate future in the same time scale. This picture would suggest that the basic difference between us and our cousins is not at the level of genome as it is usually understood but at the level of the hierarchy of magnetic bodies [K38, K22]. In fact, higher levels of dark matter hierarchy motivate the introduction of the notions of super-genome and hyper-genome. The genomes of entire organ can join to form super-genome expressing genes coherently. Hyper-genomes would result from the fusion of genomes of different organisms and collective levels of consciousness would express themselves via hyper-genome and make possible social rules and moral.

### 1.3 Bird's eye of view about the topics of the book

This book is devoted to a detailed representation of what quantum TGD in its recent form. Quantum TGD relies on two different views about physics: physics as an infinite-dimensional spinor geometry and physics as a generalized number theory. The most important guiding principle is quantum classical correspondence whose most profound implications follow almost trivially from the basic structure of the classical theory forming an exact part of quantum theory. A further mathematical guideline is the mathematics associated with hyper-finite factors of type  $II_1$  about which the spinors of the world of classical worlds represent a canonical example.

#### 1. Quantum classical correspondence

Quantum classical correspondence has turned out to be the most important guiding principle concerning the interpretation of the theory.

1. Quantum classical correspondence and the properties of the simplest extremals of Kähler action have served as the basic guideline in the attempts to understand the new physics predicted by TGD. The most dramatic predictions follow without even considering field equations in detail by using quantum classical correspondence and form the backbone of TGD and TGD inspired theory of living matter in particular.

The notions of many-sheeted space-time, topological field quantization and the notion of field/magnetic body, follow from simple topological considerations. The observation that space-time sheets can have arbitrarily large sizes and their interpretation as quantum coherence regions forces to conclude that in TGD Universe macroscopic and macro-temporal quantum coherence are possible in arbitrarily long scales.

2. Also long ranged classical color and electro-weak fields are an unavoidable prediction. It however took a considerable time to make the obvious conclusion: TGD Universe is fractal containing fractal copies of standard model physics at various space-time sheets and labeled by the collection of p-adic primes assignable to elementary particles and by the level of dark matter hierarchy characterized partially by the value of Planck constant labeling the pages of the book like structure formed by singular covering spaces of the imbedding space  $M^4 \times CP_2$  glued together along a four-dimensional back. Particles at different pages are dark relative to each other since purely local interactions defined in terms of the vertices of Feynman diagram involve only particles at the same page.
3. The new view about energy and time finding a justification in the framework of zero energy ontology means that the sign of the inertial energy depends on the time orientation of the space-time sheet and that negative energy space-time sheets serve as correlates for communications to the geometric future. This alone leads to profoundly new views about metabolism, long term memory, and realization of intentional action.
4. The general properties of Kähler action, in particular its vacuum degeneracy and the failure of the classical determinism in the conventional sense, have also strong implications. Space-time

surface as a generalization of Bohr orbit provides not only a representation of quantum states but also of sequences of quantum jumps and thus contents of consciousness. Vacuum degeneracy implies spin glass degeneracy in 4-D sense reflecting quantum criticality which is the fundamental characteristic of TGD Universe.

5. The detailed study of the simplest extremals of Kähler action interpreted as correlates for asymptotic self organization patterns provides additional insights.  $CP_2$  type extremals representing elementary particles, cosmic strings, vacuum extremals, topological light rays ("massless extremal", ME), flux quanta of magnetic and electric fields represent the basic extremals. Pairs of wormhole throats identifiable as parton pairs define a completely new kind of particle carrying only color quantum numbers in ideal case and I have proposed their interpretation as quantum correlates for Boolean cognition. MEs and flux quanta of magnetic and electric fields are of special importance in living matter.

Topological light rays have interpretation as space-time correlates of "laser beams" of ordinary or dark photons or their electro-weak and gluonic counterparts. Neutral MEs carrying em and  $Z^0$  fields are ideal for communication purposes and charged  $W$  MEs ideal for quantum control. Magnetic flux quanta containing dark matter are identified as intentional agents quantum controlling the behavior of the corresponding biological body parts utilizing negative energy  $W$  MEs. Bio-system in turn is populated by electrets identifiable as electric flux quanta.

## 2. Physics as infinite-dimensional geometry in the "world of classical worlds"

Physics as infinite-dimensional Kähler geometry of the "world of classical worlds" with classical spinor fields representing the quantum states of the universe and gamma matrix algebra geometrizing fermionic statistics is the first vision.

The mere existence of infinite-dimensional non-flat Kähler geometry has impressive implications. Configuration space must decompose to a union of infinite-dimensional symmetric spaces labelled by zero modes having interpretation as classical dynamical degrees of freedom assumed in quantum measurement theory. Infinite-dimensional symmetric space has maximal isometry group identifiable as a generalization of Kac Moody group obtained by replacing finite-dimensional group with the group of canonical transformations of  $\delta M_+^4 \times CP_2$ , where  $\delta M_+^4$  is the boundary of 4-dimensional future light-cone. The infinite-dimensional Clifford algebra of configuration space gamma matrices in turn can be expressed as direct sum of von Neumann algebras known as hyper-finite factors of type  $II_1$  having very close connections with conformal field theories, quantum and braid groups, and topological quantum field theories.

## 3. Physics as a generalized number theory

Second vision is physics as a generalized number theory. This vision forces to fuse real physics and various p-adic physics to a single coherent whole having rational physics as their intersection and poses extremely strong conditions on real physics.

A further aspect of this vision is the reduction of the classical dynamics of space-time sheets to number theory with space-time sheets identified as what I have christened hyper-quaternionic sub-manifolds of hyper-octonionic imbedding space. Field equations would state that space-time surfaces are Kähler calibrations with Kähler action density reducing to a closed 4-form at space-time surfaces. Hence TGD would define a generalized topological quantum field theory with conserved Noether charges (in particular rest energy) serving as generalized topological invariants having extremum in the set of topologically equivalent 3-surfaces.

Infinite primes, integers, and rationals define the third aspect of this vision. The construction of infinite primes is structurally similar to a repeated second quantization of an arithmetic quantum field theory and involves also bound states. Infinite rationals can be also represented as space-time surfaces somewhat like finite numbers can be represented as space-time points.

## 4. The organization of the book

The first part of the book describes basic quantum TGD in its recent form.

1. The properties of the preferred extremals of Kähler action are crucial for the construction and the discussion of known extremals is therefore included.



2. General coordinate invariance and generalized super-conformal symmetries - the latter present only for 4-dimensional space-time surfaces and for 4-D Minkowski space - define the basic symmetries of quantum TGD. A generalization of Equivalence Principle can be formulated as a generalized coset construction.
3. In zero energy ontology S-matrix is replaced with M-matrix and identified as time-like entanglement coefficients between positive and negative energy parts of zero energy states assignable to the past and future boundaries of 4-surfaces inside causal diamond defined as intersection of future and past directed light-cones. M-matrix is a product of diagonal density matrix and unitary S-matrix and there are reasons to believe that S-matrix is universal. Generalized Feynman rules based on the generalization of Feynman diagrams obtained by replacing lines with light-like 3-surfaces and vertices with 2-D surfaces at which the lines meet.
4. A category theoretical formulation of quantum TGD is considered. Finite measurement resolution realized in terms of a fractal hierarchy of causal diamonds inside causal diamonds leads to a stringy formulation of quantum TGD involving effective replacement of the 3-D light-like surface with a collection of braid strands representing the ends of strings. A formulation in terms of category theoretic concepts is proposed and leads to a hierarchy of algebras forming what is known as operads.
5. Twistors emerge naturally in TGD framework and could allow the formulation of low energy limit of the theory in the approximation that particles are massless. The replacement of massless plane waves with states for which amplitudes are localized are light-rays is suggestive in twistor theoretic framework. Twistors could allow also a dual representation of space-time surfaces in terms of surfaces of  $X \times CP_2$ , where  $X$  is 8-D twistor space or its 6-D projective variant. These surfaces would have dimension higher than four in non-perturbative phases meaning an analogy with branes. In full theory a massive particles must be included but represent a problem in approach based on standard twistors. The interpretation of massive particles in 4-D sense as massless particles in 8-D sense would resolve the problem and requires a generalization of twistor concept involving in essential manner the triality of vector and spinor representations of  $SO(7,1)$ .
6. In TGD Universe bosons are in well-defined sense bound states of fermion and anti-fermion. This leads to the notion of bosonic emergence meaning that the fundamental action is just Dirac action coupled to gauge potentials and bosonic action emerges as part of effective action as one functionally integrates over the spinor fields. This kind of approach predicts the evolution of all coupling constants if one is able to fix the necessary UV cutoffs of mass and hyperbolic angle in loop integrations. The guess for the hyperbolic cutoff motivated by the geometric view about finite measurement resolution predicts coupling constant evolution which is consistent with that predicted by standard model. The condition that all N-vertices defined by fermionic loops vanish for  $N > 3$  when incoming particles are massless gives hopes of fixing completely the hyperbolic cutoff from fundamental principles.

Second part of the book is devoted to hyper-finite factors and hierarchy of Planck constants.

1. Configuration space spinors indeed define a canonical example about hyper-finite factor of type  $II_1$ . The work with TGD inspired model for quantum computation led to the realization that von Neumann algebras, in particular hyper-finite factors of type  $II_1$  could provide the mathematics needed to develop a more explicit view about the construction of M-matrix. This has turned out to be the case to the extent that a general master formula for M-matrix with interactions described as a deformation of ordinary tensor product to Connes tensor products emerges.
2. The idea about hierarchy of Planck constants emerged from anomalies of biology and the strange finding that planetary orbits could be regarded as Bohr orbits but with a gigantic value of Planck constant. This led to the vision that dark matter corresponds to ordinary particles but with non-standard value of Planck constant and to a generalization of the 8-D imbedding space to a book like structure with pages partially characterized by the value of Planck constant. Using the intuition provided by the inclusions of hyper-finite factors of type  $II_1$  one ends up to a prediction for the spectrum of Planck constants associated with  $M^4$  and  $CP_2$  degrees of freedom. This

inspires the proposal that dark matter could be in quantum Hall like phase localized at light-like 3-surfaces with macroscopic size and behaving in many respects like black hole horizons.

The seven online books about TGD [K80, K60, K61, K70, K48, K45, K68] and eight online books about TGD inspired theory of consciousness and quantum biology [K74, K12, K53, K10, K29, K36, K40, K67] are warmly recommended for the reader willing to get overall view about what is involved.

## 1.4 The contents of the book

### 1.4.1 Part I: The recent view about field equations

#### Basic extremals of the Kähler action

The physical interpretation of the Kähler function and the TGD based space-time concept are the basic themes of this book. The aim is to develop what might be called classical TGD at fundamental level. The strategy is simple: try to guess the general physical consequences of the configuration space geometry and of the TGD based gauge field concept and study the simplest extremals of Kähler action and try to abstract general truths from their properties.

The fundamental underlying assumptions are the following:

1. The 4-surface associated with given 3-surface defined by Kähler function  $K$  as a preferred extremal of the Kähler action is identifiable as a classical space-time. Number theoretically preferred extremals would decompose to hyper-quaternionic and co-hyper-quaternionic regions. The reduction of the classical theory to the level of the modified Dirac action implies that the preferred extremals are critical in the sense of allowing infinite number of deformations for which the second variation of Kähler action vanishes [?] It is not clear whether criticality and hyper-quaternionicity are consistent with each other.

Due to the preferred extremal property classical space-time can be also regarded as a generalized Bohr orbit so that the quantization of the various parameters associated with a typical extremal of the Kähler action is expected to take place in general. In TGD quantum states corresponds to quantum superpositions of these classical space-times so that this classical space-time is certainly not some kind of effective quantum average space-time.

2. The bosonic vacuum functional of the theory is the exponent of the Kähler function  $\Omega_B = \exp(K)$ . This assumption is the only assumption about the dynamics of the theory and is necessitated by the requirement of divergence cancellation in perturbative approach.
3. Renormalization group invariance and spin glass analogy. The value of the Kähler coupling strength is such that the vacuum functional  $\exp(K)$  is analogous to the exponent  $\exp(H/T)$  defining the partition function of a statistical system at critical temperature. This allows Kähler coupling strength to depend on zero modes of the configuration space metric and as already found there is very attractive hypothesis determining completely the dependence of the Kähler coupling strength on the zero modes based on p-adic considerations motivated by the spin glass analogy.
4. In spin degrees of freedom the massless Dirac equation for the induced spinor fields with modified Dirac action defines classical theory: this is in complete accordance with the proposed definition of the configuration space spinor structure.

The geometrization of the classical gauge fields in terms of the induced gauge field concept is also important concerning the physical interpretation. Electro-weak gauge potentials correspond to the space-time projections of the spinor connection of  $CP_2$ , gluonic gauge potentials to the projections of the Killing vector fields of  $CP_2$  and gravitational field to the induced metric. The topics to be discussed in this part of the book are summarized briefly in the following.

What the selection of preferred extremals of Kähler action might mean has remained a long standing problem and real progress occurred only quite recently (I am writing this towards the end of year 2003).

1. The vanishing of Lorentz 4-force for the induced Kähler field means that the vacuum 4-currents are in a mechanical equilibrium. Lorentz 4-force vanishes for all known solutions of field equations which inspires the hypothesis that all preferred extremals of Kähler action satisfy the condition. The vanishing of the Lorentz 4-force in turn implies local conservation of the ordinary energy momentum tensor. The corresponding condition is implied by Einstein's equations in General Relativity. The hypothesis would mean that the solutions of field equations are what might be called generalized Beltrami fields. The condition implies that vacuum currents can be non-vanishing only provided the dimension  $D_{CP_2}$  of the  $CP_2$  projection of the space-time surface is less than four so that in the regions with  $D_{CP_2} = 4$ , Maxwell's vacuum equations are satisfied.
2. The hypothesis that Kähler current is proportional to a product of an arbitrary function  $\psi$  of  $CP_2$  coordinates and of the instanton current generalizes Beltrami condition and reduces to it when electric field vanishes. Instanton current has a vanishing divergence for  $D_{CP_2} < 4$ , and Lorentz 4-force indeed vanishes. Four 4-dimensional projection the scalar function multiplying the instanton current can make it divergenceless. The remaining task would be the explicit construction of the imbeddings of these fields and the demonstration that field equations can be satisfied.
3. By quantum classical correspondence the non-deterministic space-time dynamics should mimic the dissipative dynamics of the quantum jump sequence. Beltrami fields appear in physical applications as asymptotic self organization patterns for which Lorentz force and dissipation vanish. This suggests that preferred extremals of Kähler action correspond to space-time sheets which at least asymptotically satisfy the generalized Beltrami conditions so that one can indeed assign to the final 3-surface a unique 4-surface apart from effects related to non-determinism. Preferred extremal property abstracted to purely algebraic generalized Beltrami conditions makes sense also in the p-adic context.

This chapter is mainly devoted to the study of the basic extremals of the Kähler action besides the detailed arguments supporting the view that the preferred extrema satisfy generalized Beltrami conditions at least asymptotically.

The newest results discussed in the last section about the weak form of electric-magnetic duality suggest strongly that Beltrami property is general and together with the weak form of electric-magnetic duality allows a reduction of quantum TGD to almost topological field theory with Kähler function allowing expression as a Chern-Simons term.

The surprising implication of the duality is that Kähler form of  $CP_2$  must be replaced with that for  $S^2 \times CP_2$  in order to obtain a configuration space metric which is non-trivial in  $M^4$  degrees of freedom. This modification implies much richer vacuum structure than the original Kähler action which is a good news as far as the description of classical gravitational fields in terms of small deformations of vacuum extremals with the four-momentum density of the topologically condensed matter given by Einstein's equations is considered. The breaking of Lorentz invariance from  $SO(3,1)$  to  $SO(3)$  is implied already by the geometry of  $CD$  but is extremely small for a given causal diamond ( $CD$ ). Since a wave function over the Lorentz boosts and translates of  $CD$  is allowed, there is no actual breaking of Poincaré invariance at the level of the basic theory. Beltrami property leads to a rather explicit construction of the general solution of field equations based on the hydrodynamic picture implying that single particle quantum numbers are conserved along flow lines defined by the instanton current. The construction generalizes also to the fermionic sector.

### The recent vision about preferred extremals and solutions of the modified Dirac equation

During years several approaches to what preferred extremals of Kähler action and solutions of the modified Dirac equation could be have been proposed and the challenge is to see whether at least some of these approaches are consistent with each other. It is good to list various approaches first.

1. For preferred extremals generalization of conformal invariance to 4-D situation is very attractive approach and leads to concrete conditions formally similar to those encountered in string model. The approach based on basic heuristics for massless equations, on effective 3-dimensionality, and weak form of electric magnetic duality is also promising. An alternative approach is inspired by number theoretical considerations and identifies space-time surfaces as associative or co-associative sub-manifolds of octonionic imbedding space.

2. There are also several approaches for solving the modified Dirac equation. The most promising approach is assumes that the solutions are restricted on 2-D stringy world sheets and/or partonic 2-surfaces. This strange looking view is a rather natural consequence of number theoretic vision. The conditions stating that electric charge is conserved for preferred extremals is an alternative very promising approach.

In this chapter the question whether these various approaches are mutually consistent is discussed. It indeed turns out that the approach based on the conservation of electric charge leads under rather general assumptions to the proposal that solutions of the modified Dirac equation are localized on 2-dimensional string world sheets and/or partonic 2-surfaces. Einstein's equations are satisfied for the preferred extremals and this implies that the earlier proposal for the realization of Equivalence Principle is not needed. This leads to a considerable progress in the understanding of super Virasoro representations for super-symplectic and super-Kac-Moody algebra. In particular, the proposal is that super-Kac-Moody currents assignable to string world sheets define duals of gauge potentials and their generalization for gravitons: in the approximation that gauge group is Abelian - motivated by the notion of finite measurement resolution - the exponents for the sum of KM charges would define non-integrable phase factors. One can also identify Yangian as the algebra generated by these charges. The approach allows also to understand the special role of the right handed neutrino in SUSY according to TGD.

## 1.4.2 Part II: General Theory

### Construction of Quantum Theory: Symmetries

This chapter provides a summary about the role of symmetries in the construction of quantum TGD. The discussions are based on the general vision that quantum states of the Universe correspond to the modes of classical spinor fields in the "world of the classical worlds" identified as the infinite-dimensional configuration space of light-like 3-surfaces of  $H = M^4 \times CP_2$  (more or less-equivalently, the corresponding 4-surfaces defining generalized Bohr orbits). The following topics are discussed on basis of this vision.

TGD relies heavily on geometric ideas, which have gradually generalized during the years. Symmetries play a key role as one might expect on basis of general definition of geometry as a structure characterized by a given symmetry.

#### 1. *Physics as infinite-dimensional Kähler geometry*

1. The basic idea is that it is possible to reduce quantum theory to configuration space geometry and spinor structure. The geometrization of loop spaces inspires the idea that the mere existence of Riemann connection fixes configuration space Kähler geometry uniquely. Accordingly, configuration space can be regarded as a union of infinite-dimensional symmetric spaces labeled by zero modes labeling classical non-quantum fluctuating degrees of freedom.

The huge symmetries of the configuration space geometry deriving from the light-likeness of 3-surfaces and from the special conformal properties of the boundary of 4-D light-cone would guarantee the maximal isometry group necessary for the symmetric space property. Quantum criticality is the fundamental hypothesis allowing to fix the Kähler function and thus dynamics of TGD uniquely. Quantum criticality leads to surprisingly strong predictions about the evolution of coupling constants.

2. Configuration space spinors correspond to Fock states and anti-commutation relations for fermionic oscillator operators correspond to anti-commutation relations for the gamma matrices of the configuration space. Configuration space gamma matrices contracted with Killing vector fields give rise to a super-symplectic algebra which together with Hamiltonians of the configuration space forms what I have used to call super-symplectic algebra.

Super-symplectic degrees of freedom represent completely new degrees of freedom and have no electroweak couplings. In the case of hadrons super-symplectic quanta correspond to what has been identified as non-perturbative sector of QCD: they define TGD correlate for the degrees of freedom assignable to hadronic strings. They are responsible for the most of the mass of hadron and resolve spin puzzle of proton.

3. Besides super-symplectic symmetries there are Super-Kac Moody symmetries assignable to light-like 3-surfaces and together these algebras extend the conformal symmetries of string models to dynamical conformal symmetries instead of mere gauge symmetries. The construction of the representations of these symmetries is one of the main challenges of quantum TGD. Modular invariance is one aspect of conformal symmetries and plays a key role in the understanding of elementary particle vacuum functionals and the description of family replication phenomenon in terms of the topology of partonic 2-surfaces.
4. Modified Dirac equation gives also rise to a hierarchy super-conformal algebras assignable to zero modes. These algebras follow from the existence of conserved fermionic currents. The corresponding deformations of the space-time surface correspond to vanishing second variations of Kähler action and provide a realization of quantum criticality. This led to a breakthrough in the understanding of the modified Dirac action via the addition of a measurement interaction term to the action allowing to obtain among other things stringy propagator and the coding of quantum numbers of super-conformal representations to the geometry of space-time surfaces required by quantum classical correspondence.

### 2. *p-adic physics and p-adic variants of basic symmetries*

p-Adic mass calculations relying on p-adic length scale hypothesis led to an understanding of elementary particle masses using only super-conformal symmetries and p-adic thermodynamics. The need to fuse real physics and various p-adic physics to single coherent whole led to a generalization of the notion of number obtained by gluing together reals and p-adics together along common rationals and algebraics. The interpretation of p-adic space-time sheets is as correlates for cognition and intentionality. p-Adic and real space-time sheets intersect along common rationals and algebraics and the subset of these points defines what I call number theoretic braid in terms of which both configuration space geometry and S-matrix elements should be expressible. Thus one would obtain number theoretical discretization which involves no adhoc elements and is inherent to the physics of TGD.

### 3. *Hierarchy of Planck constants and dark matter hierarchy*

The realization for the hierarchy of Planck constants proposed as a solution to the dark matter puzzles leads to a profound generalization of quantum TGD through a generalization of the notion of imbedding space to characterize quantum criticality. The resulting space has a book like structure with various almost-copies of the imbedding space representing the pages of the book meeting at quantum critical sub-manifolds. A particular page of the book can be seen as an n-fold singular covering or factor space of  $CP_2$  or of a causal diamond ( $CD$ ) of  $M^4$  defined as an intersection of the future and past directed light-cones. Therefore the cyclic groups  $Z_n$  appear as discrete symmetry groups.

### 4. *Number theoretical symmetries*

TGD as a generalized number theory vision leads to the idea that also number theoretical symmetries are important for physics.

1. There are good reasons to believe that the strands of number theoretical braids can be assigned with the roots of a polynomial which suggests the interpretation corresponding Galois groups as purely number theoretical symmetries of quantum TGD. Galois groups are subgroups of the permutation group  $S_\infty$  of infinitely many objects acting as the Galois group of algebraic numbers. The group algebra of  $S_\infty$  is HFF which can be mapped to the HFF defined by configuration space spinors. This picture suggests a number theoretical gauge invariance stating that  $S_\infty$  acts as a gauge group of the theory and that global gauge transformations in its completion correspond to the elements of finite Galois groups represented as diagonal groups of  $G \times G \times \dots$  of the completion of  $S_\infty$ .
2. HFFs inspire also an idea about how entire TGD emerges from classical number fields, actually their complexifications. In particular,  $SU(3)$  acts as subgroup of octonion automorphisms leaving invariant preferred imaginary unit. If space-time surfaces are hyper-quaternionic (meaning that the octonionic counterparts of the modified gamma matrices span complex quaternionic sub-algebra of octonions) and contain at each point a preferred plane  $M^2$  of  $M^4$ , one ends up with

$M^8 - H$  duality stating that space-time surfaces can be equivalently regarded as surfaces in  $M^8$  or  $M^4 \times CP_2$ . One can actually generalize  $M^2$  to a two-dimensional Minkowskian sub-manifold of  $M^4$ . One ends up with quantum TGD by considering associative sub-algebras of the local octonionic Clifford algebra of  $M^8$  or  $H$ . so that TGD could be seen as a generalized number theory.

### Construction of Quantum Theory: M-matrix

The construction of  $M$ -matrix has remained the key challenge of quantum TGD from the very beginning when it had become clear that path integral approach and canonical quantization make no sense in TGD framework. My intuitive feeling that the problems are not merely technical has turned out to be correct.

The rapid evolution of a bundle of new ideas has taken place during last five years (zero energy ontology, the notion of finite measurement resolution, the role of hyper-finite factors of type  $II_1$ , the hierarchy of Planck constants, the construction of configuration space geometry in terms of second quantized induced spinor fields, number theoretic compactification,...). These ideas are now converging to an overall view in which various approaches to quantum TGD (physics as infinite dimensional geometry, physics as generalized number theory, physics from number theoretical universality, physics from finite measurement resolution implying effective discretization, TGD as almost topological QFT) neatly fuse together to single coherent overall view. Many ideas have been of course thrown away because they have not produced anything useful.

In this chapter the overall view about the construction of the TGD counterpart of  $S$ -matrix -  $M$ -matrix - is discussed. It is perhaps wise to summarize briefly the vision about  $M$ -matrix.

#### 1. Zero energy ontology and interpretation of light-like 3-surfaces as generalized Feynman diagrams

1. Zero energy ontology is the cornerstone of the construction. Zero energy states have vanishing net quantum numbers and consist of positive and negative energy parts, which can be thought of as being localized at the boundaries of light-like 3-surface  $X_l^3$  connecting the light-like boundaries of a causal diamond  $CD$  identified as intersection of future and past directed light-cones. There is entire hierarchy of  $CD$ s, whose scales are suggested to come as powers of 2. A more general proposal is that prime powers of fundamental size scale are possible and would conform with the most general form of p-adic length scale hypothesis. The hierarchy of size scales assignable to  $CD$ s corresponds to a hierarchy of length scales and code for a hierarchy of radiative corrections to generalized Feynman diagrams.
2. Light-like 3-surfaces are the basic dynamical objects of quantum TGD and have interpretation as generalized Feynman diagrams having light-like 3-surfaces as lines glued together along their ends defining vertices as 2-surfaces. By effective 2-dimensionality (holography) of light-like 3-surfaces the interiors of light-like 3-surfaces are analogous to gauge degrees of freedom and partially parameterized by Kac-Moody group respecting the light-likeness of 3-surfaces. This picture differs dramatically from that of string models since light-like 3-surfaces replacing stringy diagrams are singular as manifolds whereas 2-surfaces representing vertices are not.

#### 2. Identification of the counterpart of $S$ -matrix as time-like entanglement coefficients

1. The TGD counterpart of  $S$ -matrix - call it  $M$ -matrix- defines time-like entanglement coefficients between positive and negative energy parts of zero energy state located at the light-like boundaries of  $CD$ . One can also assign to quantum jump between zero energy states a matrix- call it  $U$ -matrix - which is unitary and assumed to be expressible in terms of  $M$ -matrices.  $M$ -matrix need not be unitary unlike the  $U$ -matrix characterizing the unitary process forming part of quantum jump. There are several good arguments suggesting that that  $M$ -matrix cannot be unitary but can be regarded as thermal  $S$ -matrix so that thermodynamics would become an essential part of quantum theory. In fact,  $M$ -matrix can be decomposed to a product of positive diagonal matrix identifiable as square root of density matrix and unitary matrix so that quantum theory would be kind of square root of thermodynamics. Path integral formalism is given up although functional integral over the 3-surfaces is present.

2. In the general case only thermal  $M$ -matrix defines a normalizable zero energy state so that thermodynamics becomes part of quantum theory. One can assign to  $M$ -matrix a complex parameter whose real part has interpretation as interaction time and imaginary part as the inverse temperature.

### 3. Hyper-finite factors and $M$ -matrix

HFFs of type III<sub>1</sub> provide a general vision about  $M$ -matrix.

1. The factors of type III allow unique modular automorphism  $\Delta^{it}$  (fixed apart from unitary inner automorphism). This raises the question whether the modular automorphism could be used to define the  $M$ -matrix of quantum TGD. This is not the case as is obvious already from the fact that unitary time evolution is not a sensible concept in zero energy ontology.
2. Concerning the identification of  $M$ -matrix the notion of state as it is used in theory of factors is a more appropriate starting point than the notion modular automorphism but as a generalization of thermodynamical state is certainly not enough for the purposes of quantum TGD and quantum field theories (algebraic quantum field theorists might disagree!). Zero energy ontology requires that the notion of thermodynamical state should be replaced with its "complex square root" abstracting the idea about  $M$ -matrix as a product of positive square root of a diagonal density matrix and a unitary  $S$ -matrix. This generalization of thermodynamical state -if it exists- would provide a firm mathematical basis for the notion of  $M$ -matrix and for the fuzzy notion of path integral.
3. The existence of the modular automorphisms relies on Tomita-Takesaki theorem, which assumes that the Hilbert space in which HFF acts allows cyclic and separable vector serving as ground state for both HFF and its commutant. The translation to the language of physicists states that the vacuum is a tensor product of two vacua annihilated by annihilation oscillator type algebra elements of HFF and creation operator type algebra elements of its commutant isomorphic to it. Note however that these algebras commute so that the two algebras are not hermitian conjugates of each other. This kind of situation is exactly what emerges in zero energy ontology: the two vacua can be assigned with the positive and negative energy parts of the zero energy states entangled by  $M$ -matrix.
4. There exists infinite number of thermodynamical states related by modular automorphisms. This must be true also for their possibly existing "complex square roots". Physically they would correspond to different measurement interactions giving rise to Kähler functions of WCW differing only by a real part of holomorphic function of complex coordinates of WCW and arbitrary function of zero mode coordinates and giving rise to the same Kähler metric of WCW.

### 4. Connes tensor product as a realization of finite measurement resolution

The inclusions  $\mathcal{N} \subset \mathcal{M}$  of factors allow an attractive mathematical description of finite measurement resolution in terms of Connes tensor product but do not fix  $M$ -matrix as was the original optimistic belief.

1. In zero energy ontology  $\mathcal{N}$  would create states experimentally indistinguishable from the original one. Therefore  $\mathcal{N}$  takes the role of complex numbers in non-commutative quantum theory. The space  $\mathcal{M}/\mathcal{N}$  would correspond to the operators creating physical states modulo measurement resolution and has typically fractal dimension given as the index of the inclusion. The corresponding spinor spaces have an identification as quantum spaces with non-commutative  $\mathcal{N}$ -valued coordinates.
2. This leads to an elegant description of finite measurement resolution. Suppose that a universal  $M$ -matrix describing the situation for an ideal measurement resolution exists as the idea about square root of state encourages to think. Finite measurement resolution forces to replace the probabilities defined by the  $M$ -matrix with their  $\mathcal{N}$  "averaged" counterparts. The "averaging" would be in terms of the complex square root of  $\mathcal{N}$ -state and a direct analog of functionally or path integral over the degrees of freedom below measurement resolution defined by (say) length scale cutoff.

3. One can construct also directly M-matrices satisfying the measurement resolution constraint. The condition that  $\mathcal{N}$  acts like complex numbers on M-matrix elements as far as  $\mathcal{N}$ -"averaged" probabilities are considered is satisfied if M-matrix is a tensor product of M-matrix in  $\mathcal{M}(\mathcal{N}$  interpreted as finite-dimensional space with a projection operator to  $\mathcal{N}$ . The condition that  $\mathcal{N}$  averaging in terms of a complex square root of  $\mathcal{N}$  state produces this kind of M-matrix poses a very strong constraint on M-matrix if it is assumed to be universal (apart from variants corresponding to different measurement interactions).

#### 5. *Input from the construction of configuration space spinor structure*

The construction of configuration space spinor structure in terms of second quantized induced spinor fields is certainly the most important step made hitherto towards explicit formulas for M-matrix elements.

1. Number theoretical compactification ( $M^8 - H$  duality) states that space-time surfaces can be equivalently regarded as 4-dimensional surfaces of either  $H = M^4 \times CP_2$  or of 8-D Minkowski space  $M^8$ , and consisting of hyper-quaternionic and co-hyper-quaternionic regions identified as regions with Minkowskian and Euclidian signatures of induced metric. Duality preserves induced metric and Kähler form. This duality poses very strong constraints on the geometry of the preferred extremals of Kähler action implying dual slicings of the space-time surface by string worlds sheets and partonic 2-surfaces as also by light-like 1-surfaces and light-like 3-surfaces. These predictions are consistent what is known about the extremals of Kähler action. The predictions of number theoretical compactification lead to dramatic progress in the construction of configurations space spinor structure and geometry. One consequence is dimensional reduction of space-time surface to string world sheet allowing to understand how the space-time correlate for Equivalence Principle is realized in TGD framework (its quantum counterpart emerges from coset construction for super-symplectic and super Kac-Moody algebras).
2. The construction of configuration space geometry and spinor structure in terms of induced spinor fields leads to the conclusion that finite measurement resolution is an intrinsic property of quantum states basically due to the vacuum degeneracy of Kähler action. This gives a justification for the notion of number theoretic braid effectively replacing light-like 3-surfaces. Hence the infinite-dimensional configuration space is replaced with a finite-dimensional space  $(\delta M_{\pm}^4 \times CP_2)^n / S_n$ . A possible interpretation is that the finite fermionic oscillator algebra for given partonic 2-surface  $X^2$  represents the factor space  $\mathcal{M}/\mathcal{N}$  identifiable as quantum variant of Clifford algebra.  $(\delta M_{\pm}^4 \times CP_2)^n / S_n$  would represent its bosonic analog.
3. The isometries of the configuration space corresponds to  $X^2$  local symplectic transformations  $\delta M_{\pm}^4 \times CP_2$  depending only on the value of the invariant  $\epsilon^{\mu\nu} J_{\mu\nu}$ , where  $J_{\mu\nu}$  can correspond to the Kähler form induced from  $\delta M_{\pm}^4$  or  $CP_2$ . This group parameterizes quantum fluctuating degrees of freedom. Zero modes correspond to coordinates which cannot be made complex, in particular to the values of the induced symplectic form which thus behaves as a classical field so that configuration space allows a slicing by the classical field patterns  $J_{\mu\nu}(x)$  representing zero modes.
4. By the effective 2-dimensionality of light-like 3-surfaces  $X_l^3$  (holography) the interiors of light-like 3-surfaces are analogous to gauge degrees of freedom and partially parameterized by Kac-Moody group respecting the light-likeness of 3-surfaces. Quantum classical correspondence suggests that gauge fixing in Kac-Moody degrees of freedom takes place and implies correlation between the quantum numbers of the physical state and  $X_l^3$ . There would be no path integral over  $X_l^3$  and only functional integral defined by configuration space geometry over partonic 2-surfaces.
5. The condition that the Noether currents assignable to the modified Dirac equation are conserved requires that space-time surfaces correspond to extremals for which second variation of Kähler action vanishes. A milder condition is that the rank of the matrix defined by the second variation of Kähler action is less than maximal. Preferred extremals of Kähler action can be identified as this kind of 4-surface and the interpretation is in terms of quantum criticality.

#### 6. *Conformal symmetries and stringy diagrammatics*



The modified Dirac equation has rich super-conformal symmetries helping to achieve concrete vision about the structure of  $M$ -matrix in terms of generalized Feynman diagrammatics

1. Both super-conformal symmetries, the slicing of space-time surface by string worlds sheets, and the reduction of space-time sheet to string world sheet as a consequence of finite measurement resolution suggest that the generalized Feynman diagrams have as vertices  $N$ -point functions of a conformal field theory assignable to the partonic 2-surfaces at which the lines of Feynman diagram meet. Finite measurement resolution means that this conformal theory is defined in the discrete set defined by the number theoretic braid. The presence of symplectic invariants in turn suggest a symplectic variant of conformal field theory leading to a concrete construction of symplectic fusion rules relying in crucial manner to discretization.
2. The effective 3-dimensionality implied by the modified Dirac operator associated with Kähler action plays crucial role in the construction of both configuration space geometry (Kähler function is identified as Dirac determinant assignable to the modified Dirac operator) and of  $M$ -matrix. By effective 3-dimensionality the propagators reduce to the propagators assignable the light-like 3-surfaces. This does not give stringy propagators and massive stringy excitations would not appear at all in propagators. This does not conform with what  $p$ -adic mass calculations and conformal symmetries suggest.
3. The solution of the problem is provided by the addition of measurement interaction term to the modified Dirac action and assignable to wormhole throats or equivalently any light-like 3-surface parallel to them in the slicing of space-time sheet: this condition defines additional symmetry. Measurement interaction term implies that the preferred extremals of Kähler action depend on quantum numbers of the states of super-conformal representations as quantum classical correspondence requires. The coupling constants appearing in the measurement interaction term are fixed by the condition that Kähler function transforms only by a real part of a holomorphic function of complex coordinates of WCW depending also on zero modes so that Kähler metric of WCW remains unchanged. This realizes also the effective 2-dimensionality of space-like 3-surfaces but only in finite regions where the slicing by light-like 3-surfaces makes sense.

#### 7. TGD as almost topological QFT

The idea that TGD could be regarded as almost topological QFT has been very fruitful although the hypothesis that Chern-Simons term for induced Kähler gauge potential assignable to light-like 3-surfaces identified as regions of space-time where the Euclidian signature of induced metric assignable to the interior or generalized Feynman diagram changes to Minkowskian one turned out to be too strong. The reduction of configuration space and its Clifford algebra to finite dimensional structures due to finite measurement resolution however realizes this idea but in different manner.

1. There is functional integral over the small deformations of Feynman cobordisms corresponding to the maxima of Kähler function which is finite-dimensional if finite measurement resolution is taken into account. Almost topological QFT property of quantum suggests the identification of  $M$ -matrix as a functor from the category of generalized Feynman cobordisms (generalized Feynman diagrams) to the category of operators mapping the Hilbert space of positive energy states to that for negative energy states: these Hilbert spaces are assignable to partonic 2-surfaces.
2. The limit at which momenta vanish is well-defined for  $M$ -matrix since the modified Dirac action contains measurement interaction term and at this limit one indeed obtains topological QFT.
3. Almost TQFT property suggests that braiding  $S$ -matrices should have important role in the construction. It is indeed possible to assign the with the lines of the generalized Feynman diagram. The reduction of quantum TGD to topological QFT should occur at quantum criticality with respect to the change of Planck constant since in this situation the  $M$ -matrix should not depend at all on Planck constant. Factoring QFTs in 1+1 dimensions give examples of this kind of theories.

#### 8. Bosonic emergence

The construction of QFT limit of quantum TGD based on the notion of bosonic emergence led to the most concrete picture about M-matrix achieved hitherto.

1. An "almost stringy" fermion propagator arises as one adds to the modified Dirac action a term coupling the charges in a Cartan algebra of the isometry group of  $H = M^4 \times CP_2$  to conserved fermionic currents (there are several of them). Also more general observables allow this kind of coupling and the interpretation in terms of measurement interaction. This term also realizes quantum classical correspondence by feeding information about quantum numbers of partons to the geometry of space-time sheet so that quantum numbers entangle with the geometry of space-time sheet as holography requires. This measurement interaction was the last piece in the puzzle "What are the basic equations of quantum TGD" and unified several visions about the physics predicted by quantum TGD. "Almost stringy" means that the on mass shell fermions obey stringy mass formulas dictated by super-conformal symmetry but that propagator itself -although it depends on four-momentum- is not the inverse of super-Virasoro generator  $G_0$  as it would be in string models.
2. The identification of bosons as wormhole contacts means that bosonic propagation reduces to a propagation of fermion and antifermion at opposite throats of the wormhole throat. In this framework bosonic n-vertex would correspond to the decay of bosons to fermion-antifermion pairs in the loop. Purely bosonic gauge boson couplings would be generated radiatively from triangle and box diagrams involving only fermion-boson couplings. In particular, bosonic propagator would be generated as a self-energy loop: bosons would propagate by decaying to fermion-antifermion pair and then fusing back to the boson. TGD counterpart for gauge theory dynamics would be emergent and bosonic couplings would have form factors with IR and UV behaviors allowing finiteness of the loops constructed from them since the constraint that virtual fermion pair corresponds to wormhole contact poses strong constraint on virtual momenta of fermion and antifermion.

This picture leads to generalized Feynman rules for M-matrix. The QFT limit based on this picture is able to reproduce the p-adic length scale evolution of various gauge coupling strengths with simple cutoffs on mass squared and hyperbolic angle characterizing the state of fermion in the rest system of virtual boson. The presence of these cutoffs is dictated by geometric picture about loops provided by zero energy ontology. The condition that the bosonic  $N > 3$ -vertices vanish when incoming states are on mass shell gives an infinite number of conditions which could fix the cutoffs uniquely.

### More about Matrices

This chapter is a second part of chapter representing material related to the construction of U-, M, and S-matrices. The general philosophy is discussed in the first part of the chapter and I will not repeat the discussion.

The views about  $M$ -matrix as a characterizer of time-like entanglement and  $M$ -matrix as a functor are analyzed. The role of hyper-finite factors in the construction of  $M$ -matrix is considered. One section is devoted to the possibility that Connes tensor product could define fundamental vertices. The last section is devoted to the construction of unitary  $U$ -matrix characterizing the unitary process forming part of quantum jump.

The last section is about the anatomy of quantum jump. The first part of the chapter began with a similar piece of text. This reflects the fact that the ideas are developing all the time so that the vision about the matrices is by no means top-down view beginning from precisely state assumption and proceeding to conclusions.

### Category Theory and Quantum TGD

Possible applications of category theory to quantum TGD are discussed. The so called 2-plectic structure generalizing the ordinary symplectic structure by replacing symplectic 2-form with 3-form and Hamiltonians with Hamiltonian 1-forms has a natural place in TGD since the dynamics of the light-like 3-surfaces is characterized by Chern-Simons type action. The notion of planar operad was developed for the classification of hyper-finite factors of type  $II_1$  and its mild generalization allows to

understand the combinatorics of the generalized Feynman diagrams obtained by gluing 3-D light-like surfaces representing the lines of Feynman diagrams along their 2-D ends representing the vertices.

The fusion rules for the symplectic variant of conformal field theory, whose existence is strongly suggested by quantum TGD, allow rather precise description using the basic notions of category theory and one can identify a series of finite-dimensional nilpotent algebras as discretized versions of field algebras defined by the fusion rules. These primitive fusion algebras can be used to construct more complex algebras by replacing any algebra element by a primitive fusion algebra. Trees with arbitrary numbers of branches in any node characterize the resulting collection of fusion algebras forming an operad. One can say that an exact solution of symplectic scalar field theory is obtained.

Conformal fields and symplectic scalar field can be combined to form symplecto-formal fields. The combination of symplectic operad and Feynman graph operad leads to a construction of Feynman diagrams in terms of  $n$ -point functions of conformal field theory. M-matrix elements with a finite measurement resolution are expressed in terms of a hierarchy of symplecto-conformal  $n$ -point functions such that the improvement of measurement resolution corresponds to an algebra homomorphism mapping conformal fields in given resolution to composite conformal fields in improved resolution. This expresses the idea that composites behave as independent conformal fields. Also other applications are briefly discussed.

### 1.4.3 Part III: Twistors, Bosonic Emergence, Space-time Supersymmetry

#### Twistors, $N = 4$ Super-Conformal Symmetry, and Quantum TGD

Twistors - a notion discovered by Penrose - have provided a fresh approach to the construction of perturbative scattering amplitudes in Yang-Mills theories and in  $N = 4$  supersymmetric Yang-Mills theory. This approach was pioneered by Witten. The latest step in the progress was the proposal by Nima Arkani-Hamed and collaborators that super Yang Mills and super gravity amplitudes might be formulated in 8-D twistor space possessing real metric signature  $(4, 4)$ . The questions considered in this chapter are following.

1. Could twistor space could provide a natural realization of  $N = 4$  super-conformal theory requiring critical dimension  $D = 8$  and signature metric  $(4, 4)$ ? Could string like objects in TGD sense be understood as strings in twistor space? More concretely, could one in some sense lift quantum TGD from  $M^4 \times CP_2$  to 8-D twistor space  $T$  so that one would have three equivalent descriptions of quantum TGD.
2. Could one construct the preferred extremals of Kähler action in terms of twistors -may be by mimicking the construction of hyper-quaternionic *resp.* co-hyper-quaternionic surfaces in  $M^8$  as surfaces having hyper-quaternionic tangent space *resp.* normal space at each point with the additional property that one can assign to each point  $x$  a plane  $M^2(x) \subset M^4$  as sub-space or as sub-space defined by light-like tangent vector in  $M^4$ . Could one mimic this construction by assigning to each point of  $X^4$  regarded as a 4-surface in  $T$  a 4-D plane of twistor space satisfying some conditions making possible the interpretation as a tangent plane and guaranteeing the existence of a map of  $X^4$  to a surface in  $M^4 \times CP_2$ . Could twistor formalism help to resolve the integrability conditions involved?
3. Could one define 8-D counterpart of twistors in order to avoid the problems posed by the description of massive states by regarding them as massless states in 8-D context. Could the octonionic realization of 8-D gamma matrices allow to define twistors in 8-D framework? Could associativity constraint reducing twistors to quaternionic twistors locally imply effective reduction to four-dimensional twistors.

The arguments of this chapter suggest that some these questions might have affirmative answers.

#### Yangian Symmetry, Twistors, and TGD

There has been impressive steps in the understanding of  $\mathcal{N} = 4$  maximally supersymmetric YM theory possessing 4-D super-conformal symmetry. This theory is related by AdS/CFT duality to certain string theory in  $AdS_5 \times S^5$  background. Second stringy representation was discovered by

Witten and is based on 6-D Calabi-Yau manifold defined by twistors. The unifying proposal is that so called Yangian symmetry is behind the mathematical miracles involved.

In the following I will discuss briefly the notion of Yangian symmetry and suggest its generalization in TGD framework by replacing conformal algebra with appropriate super-conformal algebras. Also a possible realization of twistor approach and the construction of scattering amplitudes in terms of Yangian invariants defined by Grassmannian integrals is considered in TGD framework and based on the idea that in zero energy ontology one can represent massive states as bound states of massless particles. There is also a proposal for a physical interpretation of the Cartan algebra of Yangian algebra allowing to understand at the fundamental level how the mass spectrum of n-particle bound states could be understood in terms of the n-local charges of the Yangian algebra.

Twistors were originally introduced by Penrose to characterize the solutions of Maxwell's equations. Kähler action is Maxwell action for the induced Kähler form of  $CP_2$ . The preferred extremals allow a very concrete interpretation in terms of modes of massless non-linear field. Both conformally compactified Minkowski space identifiable as so called causal diamond and  $CP_2$  allow a description in terms of twistors. These observations inspire the proposal that a generalization of Witten's twistor string theory relying on the identification of twistor string world sheets with certain holomorphic surfaces assigned with Feynman diagrams could allow a formulation of quantum TGD in terms of 3-dimensional holomorphic surfaces of  $CP_3 \times CP_3$  mapped to 6-surfaces dual  $CP_3 \times CP_3$ , which are sphere bundles so that they are projected in a natural manner to 4-D space-time surfaces. Very general physical and mathematical arguments lead to a highly unique proposal for the holomorphic differential equations defining the complex 3-surfaces conjectured to correspond to the preferred extremals of Kähler action.

### Quantum Field Theory Limit of TGD from Bosonic Emergence

This chapter summarizes the basic mathematical realization of the modified Feynman rules hoped to give rise to a unitary M-matrix (recall that M-matrix is product of a positive square root of density matrix and unitary S-matrix in TGD framework and need not be unitary in the general case). The basic idea is that bosonic propagators emerge as fermionic loops. The approach is bottom up and leads to a precise general formulation for how the counterpart of YM action emerges from Dirac action coupled to gauge bosons and to modified Feynman rules. An essential element of the approach is a physical formulation for UV cutoff. Actually cutoff in both mass squared and hyperbolic angle is needed since Wick rotation does not make sense in TGD framework. This approach predicts all gauge couplings and assuming a geometrically very natural hyperbolic UV cutoff motivated by zero energy ontology one can understand the evolution of standard model gauge couplings and reproduce correctly the values of fine structure constant at electron and intermediate boson length scales. Also asymptotic freedom follows as a basic prediction. The UV cutoff for the hyperbolic angle as a function of p-adic length scale is somewhat ad hoc element of the model and a quantitative model for how this function could follow from the requirement of quantum criticality is formulated and discussed.

These considerations and numerical calculations lead to a general vision about how real and p-adic variants of TGD relate to each other and how p-adic fractalization takes place. As in case of twistorialization Cutkosky rules allowing unitarization of the tree amplitudes in terms of  $TT^\dagger$  contribution involving only light-like momenta seems to be the only working option and requires that  $TT^\dagger$  makes sense p-adically. The vanishing of the fermionic loops defining bosonic vertices for the incoming massless momenta emerges as a consistency condition suggested also by quantum criticality and by the fact that only BFF vertex is fundamental vertex if bosonic emergence is accepted. The vanishing of on mass shell N-vertices gives an infinite number of conditions on the hyperbolic cutoff as function of the integer  $k$  labeling p-adic length scale at the limit when bosons are massless and IR cutoff for the loop mass scale is taken to zero. It is not yet clear whether dynamical symmetries, in particular super-conformal symmetries, are involved with the realization of the vanishing conditions or whether hyperbolic cutoff is all that is needed.

### Does the QFT Limit of TGD Have Space-Time Super-Symmetry?

Contrary to the original expectations, TGD seems to allow a generalization of the space-time super-symmetry. This became clear with the increased understanding of the modified Dirac action. The

introduction of a measurement interaction term to the action allows to understand how stringy propagator results and provides profound insights about physics predicted by TGD.

The appearance of the momentum and color quantum numbers in the measurement interaction couples space-time degrees of freedom to quantum numbers and allows also to define SUSY algebra at fundamental level as anti-commutation relations of fermionic oscillator operators. Depending on the situation a finite-dimensional SUSY algebra or the fermionic part of super-conformal algebra with an infinite number of oscillator operators results. The addition of a fermion in particular mode would define particular super-symmetry. Zero energy ontology implies that fermions as wormhole throats correspond to chiral super-fields assignable to positive or negative energy SUSY algebra whereas bosons as wormhole contacts with two throats correspond to the direct sum of positive and negative energy algebra and fields which are chiral or antichiral with respect to both positive and negative energy theta parameters. This super-symmetry is badly broken due to the dynamics of the modified Dirac operator which also mixes  $M^4$  chiralities inducing massivation. Since righthanded neutrino has no electro-weak couplings the breaking of the corresponding super-symmetry should be weakest.

The question is whether this SUSY has a realization as a SUSY algebra at space-time level and whether the QFT limit of TGD could be formulated as a generalization of SUSY QFT. There are several problems involved.

1. In TGD framework super-symmetry means addition of fermion to the state and since the number of spinor modes is larger states with large spin and fermion numbers are obtained. This picture does not fit to the standard view about super-symmetry. In particular, the identification of theta parameters as Majorana spinors and super-charges as Hermitian operators is not possible.
2. The belief that Majorana spinors are somehow an intrinsic aspect of super-symmetry is however only a belief. Weyl spinors meaning complex theta parameters are also possible. Theta parameters can also carry fermion number meaning only the supercharges carry fermion number and are non-hermitian. The the general classification of super-symmetric theories indeed demonstrates that for  $D = 8$  Weyl spinors and complex and non-hermitian super-charges are possible. The original motivation for Majorana spinors might come from MSSM assuming that right handed neutrino does not exist. This belief might have also led to string theories in  $D=10$  and  $D=11$  as the only possible candidates for TOE after it turned out that chiral anomalies cancel.
3. The massivation of particles is basic problem of both SUSYs and twistor approach. The fact that particles which are massive in  $M^4$  sense can be interpreted as massless particles in  $M^4 \times CP_2$  suggests a manner to understand super-symmetry breaking and massivation in TGD framework. The octonionic realization of twistors is a very attractive possibility in this framework and quaternionicity condition guaranteeing associativity leads to twistors which are almost equivalent with ordinary 4-D twistors.
4. The first approach is based on an approximation assuming only the super-multiplets generated by right-handed neutrino or both right-handed neutrino and its antineutrino. The assumption that right-handed neutrino has fermion number opposite to that of the fermion associated with the wormhole throat implies that bosons correspond to  $\mathcal{N} = (1, 1)$  SUSY and fermions to  $\mathcal{N} = 1$  SUSY identifiable also as a short representation of  $\mathcal{N} = (1, 1)$  SUSY algebra trivial with respect to positive or negative energy algebra. This means a deviation from the standard view but the standard SUSY gauge theory formalism seems to apply in this case.
5. A more ambitious approach would put the modes of induced spinor fields up to some cutoff into super-multiplets. At the level next to the one described above the lowest modes of the induced spinor fields would be included. The very large value of  $\mathcal{N}$  means that  $\mathcal{N} \leq \exists \in$  SUSY cannot define the QFT limit of TGD for higher cutoffs. One must generalize SUSYs gauge theories to arbitrary value of  $\mathcal{N}$  but there are reasons to expect that the formalism becomes rather complex. More ambitious approach working at TGD however suggest a more general manner to avoid this problem.
  - (a) One of the key predictions of TGD is that gauge bosons and Higgs can be regarded as bound states of fermion and antifermion located at opposite throats of a wormhole contact. This implies bosonic emergence meaning that its QFT limit can be defined in terms of Dirac action. The resulting theory was discussed in detail in [?] and it was shown that bosonic

propagators and vertices can be constructed as fermionic loops so that all coupling constant follow as predictions. One must however pose cutoffs in mass squared and hyperbolic angle assignable to the momenta of fermions appearing in the loops in order to obtain finite theory and to avoid massivation of bosons. The resulting coupling constant evolution is consistent with low energy phenomenology if the cutoffs in hyperbolic angle as a function of p-adic length scale is chosen suitably.

- (b) The generalization of bosonic emergence that the TGD counterpart of SUSY is obtained by the replacement of Dirac action with action for chiral super-field coupled to vector field as the action defining the theory so that the propagators of bosons and all their super-counterparts would emerge as fermionic loops.
  - (c) The huge super-symmetries give excellent hopes about the cancelation of infinities so that this approach would work even without the cutoffs in mass squared and hyperbolic angle assignable to the momenta of fermions appearing in the loops. Cutoffs have a physical motivation in zero energy ontology but it could be an excellent approximation to take them to infinity. Alternatively, super-symmetric dynamics provides cutoffs dynamically.
6. The condition that  $\mathcal{N} = \infty$  variants for chiral and vector superfields exist fixes completely the identification of these fields in zero energy ontology.
- (a) In this framework chiral fields are generalizations of induced spinor fields and vector fields those of gauge potentials obtained by replacing them with their super-space counterparts. Chiral condition reduces to analyticity in theta parameters thanks to the different definition of hermitian conjugation in zero energy ontology ( $\theta$  is mapped to a derivative with respect to theta rather than to  $\bar{\theta}$ ) and conjugated super-field acts on the product of all theta parameters.
  - (b) Chiral action is a straightforward generalization of the Dirac action coupled to gauge potentials. The counterpart of YM action can emerge only radiatively as an effective action so that the notion emergence is now unavoidable and indeed basic prediction of TGD.
  - (c) The propagators associated with the monomials of  $n$  theta parameters behave as  $1/p^n$  so that only  $J = 0, 1/2, 1$  states propagate in normal manner and correspond to normal particles. The presence of monomials with number of thetas higher than 2 is necessary for the propagation of bosons since by the standard argument fermion and scalar loops cancel each other by super-symmetry. This picture conforms with the identification of graviton as a bound state of wormhole throats at opposite ends of string like object.
  - (d) This formulation allows also to use modified gamma matrices in the measurement interaction defining the counterpart of super variant of Dirac operator. Poincare invariance is not lost since momenta and color charges act on the tip of  $CD$  rather than the coordinates of the space-time sheet. Hence what is usually regarded as a quantum theory in the background defined by classical fields follows as exact theory. This feeds all data about space-time sheet associated with the maximum of Kähler function. In this approach WCW as a Kähler manifold is replaced by a cartesian power of  $CP_2$ , which is indeed quaternionic Kähler manifold. The replacement of light-like 3-surfaces with number theoretic braids when finite measurement resolution is introduced, leads to a similar replacement.
  - (e) Quantum TGD as a "complex square root" of thermodynamics approach suggests that one should take a superposition of the amplitudes defined by the points of a coherence region (identified in terms of the slicing associated with a given wormhole throat) by weighting the points with the Kähler action density. The situation would be highly analogous to a spin glass system since the modified gamma matrices defining the propagators would be analogous to the parameters of spin glass Hamiltonian allowed to have a spatial dependence. This would predict the proportionality of the coupling strengths to Kähler coupling strength and bring in the dependence on the size of  $CD$  coming as a power of 2 and give rise to p-adic coupling constant evolution. Since TGD Universe is analogous to 4-D spin glass, also a sum over different preferred extremals assignable to a given coherence regions and weighted by  $\exp(K)$  is probably needed.

- (f) In TGD Universe graviton is necessarily a bi-local object and the emission and absorption of graviton are bi-local processes involving two wormhole contacts: a pair of particles rather than single particle emits graviton. This is definitely something new and defies a description in terms of QFT limit using point like particles. Graviton like states would be entangled states of vector bosons at both ends of stringy curve so that gravitation could be regarded as a square of YM interactions in rather concrete sense. The notion of emergence would suggest that graviton propagator is defined by a bosonic loop. Since bosonic loop is dimensionless, IR cutoff defined by the largest  $CD$  present must be actively involved. At QFT limit one can hope a description as a bi-local process using a bi-local generalization of the QFT limit. It turns out that surprisingly simple candidate for the bi-local action exists.

### Generalized Feynman Graphs as Generalized Braids

The basic challenge of quantum TGD is to give a precise content to the notion of generalization Feynman diagram and the reduction to braids of some kind is very attractive possibility inspired by zero energy ontology. The point is that no  $n > 2$ -vertices at the level of braid strands are needed if bosonic emergence holds true.

1. For this purpose the notion of algebraic knot is introduced and the possibility that it could be applied to generalized Feynman diagrams is discussed. The algebraic structures *kei*, *quandle*, *rack*, and *biquandle* and their algebraic modifications as such are not enough. The lines of Feynman graphs are replaced by braids and in vertices braid strands redistribute. This poses several challenges: the crossing associated with braiding and crossing occurring in non-planar Feynman diagrams should be integrated to a more general notion; braids are replaced with sub-manifold braids; braids of braids ....of braids are possible; the redistribution of braid strands in vertices should be algebraized. In the following I try to abstract the basic operations which should be algebraized in the case of generalized Feynman diagrams.
2. One should be also able to concretely identify braids and 2-braids (string world sheets) as well as partonic 2-surfaces and I have discussed several identifications during last years. Legendrian braids turn out to be very natural candidates for braids and their duals for the partonic 2-surfaces. String world sheets in turn could correspond to the analogs of Lagrangian sub-manifolds or two minimal surfaces of space-time surface satisfying the weak form of electric-magnetic duality. The latter option turns out to be more plausible. Finite measurement resolution would be realized as symplectic invariance with respect to the subgroup of the symplectic group leaving the end points of braid strands invariant. In accordance with the general vision TGD as almost topological QFT would mean symplectic QFT. The identification of braids, partonic 2-surfaces and string world sheets - if correct - would solve quantum TGD explicitly at string world sheet level in other words in finite measurement resolution.
3. A brief summary of generalized Feynman rules in zero energy ontology is proposed. This requires the identification of vertices, propagators, and prescription for integrating over all 3-surfaces. It turns out that the basic building blocks of generalized Feynman diagrams are well-defined.
4. The notion of generalized Feynman diagram leads to a beautiful duality between the descriptions of hadronic reactions in terms of hadrons and partons analogous to gauge-gravity duality and AdS/CFT duality but requiring no additional assumptions. The model of quark gluon plasma as a strongly interacting phase is proposed. Color magnetic flux tubes are responsible for the long range correlations making the plasma phase more like a very large hadron rather than a gas of partons. One also ends up with a simple estimate for the viscosity/entropy ratio using black-hole analogy.

### 1.4.4 Part IV: Hyper-Finite Factors of Type II and Hierarchy of Planck Constants

#### What von Neumann Right After All?

The work with TGD inspired model for quantum computation led to the realization that von Neumann algebras, in particular hyper-finite factors, could provide the mathematics needed to develop a more

explicit view about the construction of M-matrix generalizing the notion of S-matrix in zero energy ontology. In this chapter I will discuss various aspects of hyper-finite factors and their possible physical interpretation in TGD framework. The original discussion has transformed during years from free speculation reflecting in many aspects my ignorance about the mathematics involved to a more realistic view about the role of these algebras in quantum TGD.

#### 1. Hyper-finite factors in quantum TGD

The following argument suggests that von Neumann algebras known as hyper-finite factors (HFFs) of type III<sub>1</sub> appearing in relativistic quantum field theories provide also the proper mathematical framework for quantum TGD.

1. The Clifford algebra of the infinite-dimensional Hilbert space is a von Neumann algebra known as HFF of type II<sub>1</sub>. There also the Clifford algebra at a given point (light-like 3-surface) of world of classical worlds (WCW) is therefore HFF of type II<sub>1</sub>. If the fermionic Fock algebra defined by the fermionic oscillator operators assignable to the induced spinor fields (this is actually not obvious!) is infinite-dimensional it defines a representation for HFF of type II<sub>1</sub>. Super-conformal symmetry suggests that the extension of the Clifford algebra defining the fermionic part of a super-conformal algebra by adding bosonic super-generators representing symmetries of WCW respects the HFF property. It could however occur that HFF of type II<sub>∞</sub> results.
2. WCW is a union of sub-WCWs associated with causal diamonds (CD) defined as intersections of future and past directed light-cones. One can allow also unions of CDs and the proposal is that CDs within CDs are possible. Whether CDs can intersect is not clear.
3. The assumption that the  $M^4$  proper distance  $a$  between the tips of CD is quantized in powers of 2 reproduces p-adic length scale hypothesis but one must also consider the possibility that  $a$  can have all possible values. Since  $SO(3)$  is the isotropy group of CD, the CDs associated with a given value of  $a$  and with fixed lower tip are parameterized by the Lobatchevski space  $L(a) = SO(3,1)/SO(3)$ . Therefore the CDs with a free position of lower tip are parameterized by  $M^4 \times L(a)$ . A possible interpretation is in terms of quantum cosmology with  $a$  identified as cosmic time [?] Since Lorentz boosts define a non-compact group, the generalization of so called crossed product construction strongly suggests that the local Clifford algebra of WCW is HFF of type III<sub>1</sub>. If one allows all values of  $a$ , one ends up with  $M^4 \times M^4_+$  as the space of moduli for WCW.
4. An interesting special aspect of 8-dimensional Clifford algebra with Minkowski signature is that it allows an octonionic representation of gamma matrices obtained as tensor products of unit matrix 1 and 7-D gamma matrices  $\gamma_k$  and Pauli sigma matrices by replacing 1 and  $\gamma_k$  by octonions. This inspires the idea that it might be possible to end up with quantum TGD from purely number theoretical arguments. This seems to be the case. One can start from a local octonionic Clifford algebra in  $M^8$ . Associativity condition is satisfied if one restricts the octonionic algebra to a subalgebra associated with any hyper-quaternionic and thus 4-D sub-manifold of  $M^8$ . This means that the modified gamma matrices associated with the Kähler action span a complex quaternionic sub-space at each point of the sub-manifold. This associative sub-algebra can be mapped a matrix algebra. Together with  $M^8 - H$  duality [?]his leads automatically to quantum TGD and therefore also to the notion of WCW and its Clifford algebra which is however only mappable to an associative algebra and thus to HFF of type II<sub>1</sub>.

#### 4. Hyper-finite factors and M-matrix

HFFs of type III<sub>1</sub> provide a general vision about M-matrix.

1. The factors of type III allow unique modular automorphism  $\Delta^{it}$  (fixed apart from unitary inner automorphism). This raises the question whether the modular automorphism could be used to define the M-matrix of quantum TGD. This is not the case as is obvious already from the fact that unitary time evolution is not a sensible concept in zero energy ontology.
2. Concerning the identification of M-matrix the notion of state as it is used in theory of factors is a more appropriate starting point than the notion modular automorphism but as a generalization



of thermodynamical state is certainly not enough for the purposes of quantum TGD and quantum field theories (algebraic quantum field theorists might disagree!). Zero energy ontology requires that the notion of thermodynamical state should be replaced with its "complex square root" abstracting the idea about M-matrix as a product of positive square root of a diagonal density matrix and a unitary S-matrix. This generalization of thermodynamical state -if it exists- would provide a firm mathematical basis for the notion of M-matrix and for the fuzzy notion of path integral.

3. The existence of the modular automorphisms relies on Tomita-Takesaki theorem, which assumes that the Hilbert space in which HFF acts allows cyclic and separable vector serving as ground state for both HFF and its commutant. The translation to the language of physicists states that the vacuum is a tensor product of two vacua annihilated by annihilation oscillator type algebra elements of HFF and creation operator type algebra elements of its commutant isomorphic to it. Note however that these algebras commute so that the two algebras are not hermitian conjugates of each other. This kind of situation is exactly what emerges in zero energy ontology: the two vacua can be assigned with the positive and negative energy parts of the zero energy states entangled by M-matrix.
4. There exists infinite number of thermodynamical states related by modular automorphisms. This must be true also for their possibly existing "complex square roots". Physically they would correspond to different measurement interactions giving rise to Kähler functions of WCW differing only by a real part of holomorphic function of complex coordinates of WCW and arbitrary function of zero mode coordinates and giving rise to the same Kähler metric of WCW.

The concrete construction of M-matrix utilizing the idea of bosonic emergence (bosons as fermion anti-fermion pairs at opposite throats of wormhole contact) meaning that bosonic propagators reduce to fermionic loops identifiable as wormhole contacts leads to generalized Feynman rules for M-matrix in which modified Dirac action containing measurement interaction term defines stringy propagators. This M-matrix should be consistent with the above proposal.

#### 5. Connes tensor product as a realization of finite measurement resolution

The inclusions  $\mathcal{N} \subset \mathcal{M}$  of factors allow an attractive mathematical description of finite measurement resolution in terms of Connes tensor product but do not fix M-matrix as was the original optimistic belief.

1. In zero energy ontology  $\mathcal{N}$  would create states experimentally indistinguishable from the original one. Therefore  $\mathcal{N}$  takes the role of complex numbers in non-commutative quantum theory. The space  $\mathcal{M}/\mathcal{N}$  would correspond to the operators creating physical states modulo measurement resolution and has typically fractal dimension given as the index of the inclusion. The corresponding spinor spaces have an identification as quantum spaces with non-commutative  $\mathcal{N}$ -valued coordinates.
2. This leads to an elegant description of finite measurement resolution. Suppose that a universal M-matrix describing the situation for an ideal measurement resolution exists as the idea about square root of state encourages to think. Finite measurement resolution forces to replace the probabilities defined by the M-matrix with their  $\mathcal{N}$  "averaged" counterparts. The "averaging" would be in terms of the complex square root of  $\mathcal{N}$ -state and a direct analog of functionally or path integral over the degrees of freedom below measurement resolution defined by (say) length scale cutoff.
3. One can construct also directly M-matrices satisfying the measurement resolution constraint. The condition that  $\mathcal{N}$  acts like complex numbers on M-matrix elements as far as  $\mathcal{N}$ -"averaged" probabilities are considered is satisfied if M-matrix is a tensor product of M-matrix in  $\mathcal{M}(\mathcal{N}$  interpreted as finite-dimensional space with a projection operator to  $\mathcal{N}$ ). The condition that  $\mathcal{N}$  averaging in terms of a complex square root of  $\mathcal{N}$  state produces this kind of M-matrix poses a very strong constraint on M-matrix if it is assumed to be universal (apart from variants corresponding to different measurement interactions).

#### 6. Quantum spinors and fuzzy quantum mechanics

The notion of quantum spinor leads to a quantum mechanical description of fuzzy probabilities. For quantum spinors state function reduction cannot be performed unless quantum deformation parameter equals to  $q = 1$ . The reason is that the components of quantum spinor do not commute: it is however possible to measure the commuting operators representing moduli squared of the components giving the probabilities associated with 'true' and 'false'. The universal eigenvalue spectrum for probabilities does not in general contain  $(1,0)$  so that quantum qbits are inherently fuzzy. State function reduction would occur only after a transition to  $q=1$  phase and decoherence is not a problem as long as it does not induce this transition.

### Does TGD predict spectrum of Planck constants?

The quantization of Planck constant has been the basic theme of TGD since 2005. The basic idea was stimulated by the finding of Nottale that planetary orbits could be seen as Bohr orbits with enormous value of Planck constant given by  $\hbar_{gr} = GM_1M_2/v_0$ , where the velocity parameter  $v_0$  has the approximate value  $v_0 \simeq 2^{-11}$  for the inner planets. This inspired the ideas that quantization is due to a condensation of ordinary matter around dark matter concentrated near Bohr orbits and that dark matter is in macroscopic quantum phase in astrophysical scales. The second crucial empirical input were the anomalies associated with living matter. The recent version of the chapter represents the evolution of ideas about quantization of Planck constants from a perspective given by seven years's work with the idea. A very concise summary about the situation is as follows.

#### *Basic physical ideas*

The basic phenomenological rules are simple and there is no need to modify them.

1. The phases with non-standard values of effective Planck constant are identified as dark matter. The motivation comes from the natural assumption that only the particles with the same value of effective Planck can appear in the same vertex. One can illustrate the situation in terms of the book metaphor. Imbedding spaces with different values of Planck constant form a book like structure and matter can be transferred between different pages only through the back of the book where the pages are glued together. One important implication is that light exotic charged particles lighter than weak bosons are possible if they have non-standard value of Planck constant. The standard argument excluding them is based on decay widths of weak bosons and has led to a neglect of large number of particle physics anomalies.
2. Large effective or real value of Planck constant scales up Compton length - or at least de Broglie wave length - and its geometric correlate at space-time level identified as size scale of the space-time sheet assignable to the particle. This could correspond to the Kähler magnetic flux tube for the particle forming consisting of two flux tubes at parallel space-time sheets and short flux tubes at ends with length of order  $CP_2$  size.

This rule has far reaching implications in quantum biology and neuroscience since macroscopic quantum phases become possible as the basic criterion stating that macroscopic quantum phase becomes possible if the density of particles is so high that particles as Compton length sized objects overlap. Dark matter therefore forms macroscopic quantum phases. One implication is the explanation of mysterious looking quantal effects of ELF radiation in EEG frequency range on vertebrate brain:  $E = hf$  implies that the energies for the ordinary value of Planck constant are much below the thermal threshold but large value of Planck constant changes the situation. Also the phase transitions modifying the value of Planck constant and changing the lengths of flux tubes (by quantum classical correspondence) are crucial as also reconnections of the flux tubes.

The hierarchy of Planck constants suggests also a new interpretation for FQHE (fractional quantum Hall effect) in terms of anyonic phases with non-standard value of effective Planck constant realized in terms of the effective multi-sheeted covering of imbedding space: multi-sheeted space-time is to be distinguished from many-sheeted space-time.

In astrophysics and cosmology the implications are even more dramatic. It was who first introduced the notion of gravitational Planck constant as  $\hbar_{gr} = GMm/v_0$ ,  $v_0 < 1$  has interpretation as velocity light parameter in units  $c = 1$ . This would be true for  $GMm/v_0 \geq 1$ . The interpretation of  $\hbar_{gr}$  in TGD framework is as an effective Planck constant associated with space-time

sheets mediating gravitational interaction between masses  $M$  and  $m$ . The huge value of  $\hbar_{gr}$  means that the integer  $\hbar_{gr}/\hbar_0$  interpreted as the number of sheets of covering is gigantic and that Universe possesses gravitational quantum coherence in super-astronomical scales for masses which are large. This changes the view about gravitons and suggests that gravitational radiation is emitted as dark gravitons which decay to pulses of ordinary gravitons replacing continuous flow of gravitational radiation.

3. Why Nature would like to have large effective value of Planck constant? A possible answer relies on the observation that in perturbation theory the expansion takes in powers of gauge couplings strengths  $\alpha = g^2/4\pi\hbar$ . If the effective value of  $\hbar$  replaces its real value as one might expect to happen for multi-sheeted particles behaving like single particle,  $\alpha$  is scaled down and perturbative expansion converges for the new particles. One could say that Mother Nature loves theoreticians and comes in rescue in their attempts to calculate. In quantum gravitation the problem is especially acute since the dimensionless parameter  $GMm/\hbar$  has gigantic value. Replacing  $\hbar$  with  $\hbar_{gr} = GMm/v_0$  the coupling strength becomes  $v_0 < 1$ .

#### *Space-time correlates for the hierarchy of Planck constants*

The hierarchy of Planck constants was introduced to TGD originally as an additional postulate and formulated as the existence of a hierarchy of imbedding spaces defined as Cartesian products of singular coverings of  $M^4$  and  $CP_2$  with numbers of sheets given by integers  $n_a$  and  $n_b$  and  $\hbar = n\hbar_0$ .  $n = n_a n_b$ .

With the advent of zero energy ontology, it became clear that the notion of singular covering space of the imbedding space could be only a convenient auxiliary notion. Singular means that the sheets fuse together at the boundary of multi-sheeted region. The effective covering space emerges naturally from the vacuum degeneracy of Kähler action meaning that all deformations of canonically imbedded  $M^4$  in  $M^4 \times CP_2$  have vanishing action up to fourth order in small perturbation. This is clear from the fact that the induced Kähler form is quadratic in the gradients of  $CP_2$  coordinates and Kähler action is essentially Maxwell action for the induced Kähler form. The vacuum degeneracy implies that the correspondence between canonical momentum currents  $\partial L_K/\partial(\partial_\alpha h^k)$  defining the modified gamma matrices and gradients  $\partial_\alpha h^k$  is not one-to-one. Same canonical momentum current corresponds to several values of gradients of imbedding space coordinates. At the partonic 2-surfaces at the light-like boundaries of  $CD$  carrying the elementary particle quantum numbers this implies that the two normal derivatives of  $h^k$  are many-valued functions of canonical momentum currents in normal directions.

Multi-furcation is in question and multi-furcations are indeed generic in highly non-linear systems and Kähler action is an extreme example about non-linear system. What multi-furcation means in quantum theory? The branches of multi-furcation are obviously analogous to single particle states. In quantum theory second quantization means that one constructs not only single particle states but also the many particle states formed from them. At space-time level single particle states would correspond to  $N$  branches  $b_i$  of multi-furcation carrying fermion number. Two-particle states would correspond to 2-fold covering consisting of 2 branches  $b_i$  and  $b_j$  of multi-furcation.  $N$ -particle state would correspond to  $N$ -sheeted covering with all branches present and carrying elementary particle quantum numbers. The branches co-incide at the partonic 2-surface but since their normal space data are different they correspond to different tensor product factors of state space. Also now the factorization  $N = n_a n_b$  occurs but now  $n_a$  and  $n_b$  would relate to branching in the direction of space-like 3-surface and light-like 3-surface rather than  $M^4$  and  $CP_2$  as in the original hypothesis.

Multi-furcations relate closely to the quantum criticality of Kähler action. Feigenbaum bifurcations represent a toy example of a system which via successive bifurcations approaches chaos. Now more general multi-furcations in which each branch of given multi-furcation can multi-furcate further, are possible unless on poses any additional conditions. This allows to identify additional aspect of the geometric arrow of time. Either the positive or negative energy part of the zero energy state is "prepared" meaning that single  $n$ -sub-furcations of  $N$ -furcation is selected. The most general state of this kind involves superposition of various  $n$ -sub-furcations.

#### **Mathematical speculations inspired by the hierarchy of Planck constants**

This chapter contains the purely mathematical speculations about the hierarchy of Planck constants (actually only effective hierarchy if the recent interpretation is correct) as separate from the material

describing the physical ideas, key mathematical concepts, and the basic applications. These mathematical speculations emerged during the first stormy years in the evolution of the ideas about Planck constant and must be taken with a big grain of salt. I feel myself rather conservative as compared to the fellow who produced this stuff for 7 years ago. This all is of course very relative. Many readers might experience this recent me as a reckless speculator.

The first speculative question is about possible relationship between Jones inclusions of hyperfinite factors of type  $II_1$  (hyper-finite factors are von Neuman algebras emerging naturally in TGD framework). The basic idea is that the discrete groups assignable to inclusions could correspond to discrete groups acting in the effective covering spaces of imbedding space assignable to the hierarchy of Planck constants.

There are also speculations relating to the hierarchy of Planck constants, Mc-Kay correspondence, and Jones inclusions. Even Farey sequences, Riemann hypothesis and N-tangles are discussed. Depending on reader these speculations might be experienced as irritating or entertaining. It would be interesting to go this stuff through in the light of recent understanding of the effective hierarchy of Planck constants to see what portion of it survives.

# Mathematics

- [A1] Gaussian Mersenne. <http://primes.utm.edu/glossary/xpage/GaussianMersenne.html>.
- [A2] Z. I. Borevich and I. R. Shafarevich. *Number Theory*. Academic Press, 1966.
- [A3] Eisenhart. *Riemannian Geometry*. Princeton University Press, 1964.
- [A4] C. N. Pope G. W. Gibbons.  $CP_2$  as gravitational instanton. *Comm. Math. Phys.*, 55, 1977.
- [A5] W. Hawking, S. and N. Pope, C. Generalized Spin Structures in Quantum Gravity. *Phys. Lett.*, (1), 1978.
- [A6] S. Helgason. *Differential Geometry and Symmetric Spaces*. Academic Press, New York, 1962.
- [A7] C. Itzykson and J-B. Zuber. *Quantum Field Theory*, volume 549. Mc Graw-Hill, New York, 1980.
- [A8] J. Milnor. *Topology form Differential Point of View*. The University Press of Virginia, Virginia, 1965.
- [A9] D. S. Moak. The q-analogue of the Laguerre polynomials. *J. Math. Anal. Appl.*, 81, 1981.
- [A10] N. Pope, C. Eigenfunctions and  $Spin^c$  Structures on  $CP_2$ , 1980.
- [A11] B. Shipman. The geometry of momentum mappings on generalized flag manifolds, connections with a dynamical system, quantum mechanics and the dance of honeybee. <http://math.cornell.edu/~oliver/Shipman.gif>, 1998.
- [A12] M. Spivak. *Differential Geometry I,II,III,IV*. Publish or Perish, Boston, 1970.
- [A13] J. Hanson T. Eguchi, B. Gilkey. *Phys. Rep.*, 66:1980, 1980.
- [A14] R. Thom. *Commentarii Math. Helvet.*, 28, 1954.
- [A15] Wallace. *Differential Topology*. W. A. Benjamin, New York, 1968.
- [A16] E. C. Zeeman. *Catastrophe Theory*. Addison-Wessley Publishing Company, 1977.



# Cosmology and Astro-Physics

- [E1] Age of the universe. [http://en.wikipedia.org/wiki/Age\\_of\\_the\\_universe](http://en.wikipedia.org/wiki/Age_of_the_universe).
- [E2] Allais effect. [http://en.wikipedia.org/wiki/Allais\\_effect](http://en.wikipedia.org/wiki/Allais_effect).
- [E3] Cavendish experiment. [http://en.wikipedia.org/wiki/Cavendish\\_experiment](http://en.wikipedia.org/wiki/Cavendish_experiment).
- [E4] French Nobel Laureate turns back clock. [http://science.nasa.gov/newhome/headlines/ast12oct99\\_1.htm](http://science.nasa.gov/newhome/headlines/ast12oct99_1.htm).
- [E5] French Nobel Laureate turns back clock: Marshall's global experiment, von Braun memories evoked during August 11 solar eclipse. [http://science.nasa.gov/newhome/headlines/ast12oct99\\_1.htm](http://science.nasa.gov/newhome/headlines/ast12oct99_1.htm).
- [E6] Rings of Saturn. [http://en.wikipedia.org/wiki/Rings\\_of\\_Saturn](http://en.wikipedia.org/wiki/Rings_of_Saturn).
- [E7] Saturn. <http://en.wikipedia.org/wiki/Saturn>.
- [E8] Saturnus. <http://en.wikipedia.org/wiki/Saturn>.
- [E9] M. Allais. Should the Laws of Gravitation be modified?: Part I -Abnormalities in the Motion of a Paraconical Pendulum with Anisotropic Support. *Aero/Space Engineering*, 1959, 1959.
- [E10] M. Allais. Should the Laws of Gravitation be modified?: Part II -Experiments in Connection with the Abnomralities the Motion of a Paraconical Pendulum with an Isotropic Support. *Aero/Space Engineering*, October 1959.
- [E11] M. Allais. Should the Laws of Gravitation Be Reconsidered: Part I,II,III? <http://home.t01.itscom.net/allais/blackprior/allais/lawgravit/lawgrav-one.pdf>, 1959.
- [E12] C. Charbonnel and F. Primas. The lithium content of the Galactic Halo stars. <http://arxiv.org/abs/astro-ph/0505247>, 2005.
- [E13] A. E. Nelson E. G. Adelberger, B. R. Heckel. Tests of Gravitational Inverse-Square Law. <http://www.npl.washington.edu/eotwash/pdf/review.pdf>, 2005.
- [E14] J. A. Eddy and A. A. Boornazian. Secular decrease in the solar diameter. *Bulletin of the American Astronomical Society*, 11(437):1863–1953, 1979.
- [E15] I. Mihaila et al. A new confirmation of the Allais effect during the solar eclipse of 31 2003 May. <http://home.t01.itscom.net/allais/blackprior/mihaila/2003/mihaila2003.pdf>, 2003.
- [E16] Qian-Shen Wang et al. Precise measurement of gravity variations during a total solar eclipse. *Phys. Rev. D*. <http://home.t01.itscom.net/allais/blackprior/wang/wangetal.pdf>, 62, 2000.
- [E17] S. E. Shnoll et al. Realization of discrete fluctuations in macroscopic processes. *Physics-Uspekhi*. <http://home.t01.itscom.net/allais/blackprior/shnoll/shnoll-1.pdf>, 41(10):1025–1035, 1998.
- [E18] G. I. Rusu G. T. Jeverdan and V. Antonescu. Experiments using the Foucault pendulum during the solar eclipse of 15 February, 1961. *Biblical Astronomer*, 1(55), 1981.

- [E19] G. T. Gillies. *American J. of Physics*, 58, 1990.
- [E20] R. L. Gilliland. Solar radius variations over the past 265 years. *Astrophysical Journal*, 248:1155, 1981.
- [E21] Gia Dvali Nima Arkani-Hamed, Savas Dimopoulos. The Hierarchy Problem and New Dimensions at a Millimeter. <http://arxiv.org/abs/hep-ph/9803315>, 1998.
- [E22] M. Holman R. Malhotra and T. Ito. Chaos and stability of the solar system. *Proc. Natl. Acad. Sci. USA*. <http://www.pubmedcentral.nih.gov/articlerender.fcgi?artid=60054>, 98:12342–12343, October 2001.
- [E23] D. Da Roacha and L. Nottale. Gravitational Structure Formation in Scale Relativity. <http://arxiv.org/abs/astro-ph/0310036>, 2003.
- [E24] R. N. Tran U. E. Kruse. Cavendish experiment. <http://www.ccsr.uiuc.edu/~alfred/Ph101/Notes.htm/cavendish/index.html>, 1995.
- [E25] D. Olenici V. A. Popescu. A confirmation of the Allais and Jeverdan-Rusu-Antonescu effects during the solar eclipse from 22 September 2006, and the quantization behavior of pendulum. <http://www.hessdalen.org/sse/program/Articol.pdf>, 2007.



# Books related to TGD

- [K1] M. Pitkänen. 1983.
- [K2] M. Pitkänen. Is it Possible to Understand Coupling Constant Evolution at Space-Time Level? In *Towards M-Matrix*. Onlinebook. [http://tgdtheory.com/public\\_html/tgdquant/tgdquant.html#rgflow](http://tgdtheory.com/public_html/tgdquant/tgdquant.html#rgflow), 2006.
- [K3] M. Pitkänen. About Strange Effects Related to Rotating Magnetic Systems . In *TGD and Fringe Physics*. Onlinebook. [http://tgdtheory.com/public\\_html/freenergy/freenergy.html#Faraday](http://tgdtheory.com/public_html/freenergy/freenergy.html#Faraday), 2006.
- [K4] M. Pitkänen. About the New Physics Behind Qualia. In *Quantum Hardware of Living Matter*. Onlinebook. [http://tgdtheory.com/public\\_html/bioware/bioware.html#newphys](http://tgdtheory.com/public_html/bioware/bioware.html#newphys), 2006.
- [K5] M. Pitkänen. An Overview about Quantum TGD: Part I. In *Topological Geometrodynamics: Overview*. Onlinebook. [http://tgdtheory.com/public\\_html/tgdview/tgdview.html#evoII](http://tgdtheory.com/public_html/tgdview/tgdview.html#evoII), 2006.
- [K6] M. Pitkänen. An Overview about the Evolution of Quantum TGD. In *Topological Geometrodynamics: Overview*. Onlinebook. [http://tgdtheory.com/public\\_html/tgdview/tgdview.html#evoI](http://tgdtheory.com/public_html/tgdview/tgdview.html#evoI), 2006.
- [K7] M. Pitkänen. Anomalies Related to the Classical  $Z^0$  Force and Gravitation. In *TGD and Fringe Physics*. Onlinebook. [http://tgdtheory.com/public\\_html/freenergy/freenergy.html#Zanom](http://tgdtheory.com/public_html/freenergy/freenergy.html#Zanom), 2006.
- [K8] M. Pitkänen. Appendix A: Quantum Groups and Related Structures. In *Towards M-Matrix*. Onlinebook. [http://tgdtheory.com/public\\_html/tgdquant/tgdquant.html#bialgebra](http://tgdtheory.com/public_html/tgdquant/tgdquant.html#bialgebra), 2006.
- [K9] M. Pitkänen. Basic Extremals of Kähler Action. In *Physics in Many-Sheeted Space-Time*. Onlinebook. [http://tgdtheory.com/public\\_html/tgdclass/tgdclass.html#class](http://tgdtheory.com/public_html/tgdclass/tgdclass.html#class), 2006.
- [K10] M. Pitkänen. *Bio-Systems as Conscious Holograms*. Onlinebook. [http://tgdtheory.com/public\\_html/hologram/hologram.html](http://tgdtheory.com/public_html/hologram/hologram.html), 2006.
- [K11] M. Pitkänen. Bio-Systems as Conscious Holograms. In *Bio-Systems as Conscious Holograms*. Onlinebook. [http://tgdtheory.com/public\\_html/hologram/hologram.html#hologram](http://tgdtheory.com/public_html/hologram/hologram.html#hologram), 2006.
- [K12] M. Pitkänen. *Bio-Systems as Self-Organizing Quantum Systems*. Onlinebook. [http://tgdtheory.com/public\\_html/bioselforg/bioselforg.html](http://tgdtheory.com/public_html/bioselforg/bioselforg.html), 2006.
- [K13] M. Pitkänen. Bio-Systems as Super-Conductors: part I. In *Quantum Hardware of Living Matter*. Onlinebook. [http://tgdtheory.com/public\\_html/bioware/bioware.html#superc1](http://tgdtheory.com/public_html/bioware/bioware.html#superc1), 2006.
- [K14] M. Pitkänen. Bio-Systems as Super-Conductors: part II. In *Quantum Hardware of Living Matter*. Onlinebook. [http://tgdtheory.com/public\\_html/bioware/bioware.html#superc2](http://tgdtheory.com/public_html/bioware/bioware.html#superc2), 2006.
- [K15] M. Pitkänen. Configuration Space Spinor Structure. In *Quantum Physics as Infinite-Dimensional Geometry*. Onlinebook. [http://tgdtheory.com/public\\_html/tgdgeom/tgdgeom.html#cspin](http://tgdtheory.com/public_html/tgdgeom/tgdgeom.html#cspin), 2006.

- [K16] M. Pitkänen. Construction of elementary particle vacuum functionals. In *p-Adic Length Scale Hypothesis and Dark Matter Hierarchy*. Onlinebook. [http://tgdtheory.com/public\\_html/paddark/paddark.html#elvafu](http://tgdtheory.com/public_html/paddark/paddark.html#elvafu), 2006.
- [K17] M. Pitkänen. Construction of Quantum Theory: M-matrix. In *Towards M-Matrix*. Onlinebook. [http://tgdtheory.com/public\\_html/tgdquant/tgdquant.html#towards](http://tgdtheory.com/public_html/tgdquant/tgdquant.html#towards), 2006.
- [K18] M. Pitkänen. Cosmic Strings. In *Physics in Many-Sheeted Space-Time*. Onlinebook. [http://tgdtheory.com/public\\_html/tgdclass/tgdclass.html#cstrings](http://tgdtheory.com/public_html/tgdclass/tgdclass.html#cstrings), 2006.
- [K19] M. Pitkänen. Crop Circles and Life at Parallel Space-Time Sheets. In *Magnetospheric Consciousness*. Onlinebook. [http://tgdtheory.com/public\\_html/magnconsc/magnconsc.html#crop1](http://tgdtheory.com/public_html/magnconsc/magnconsc.html#crop1), 2006.
- [K20] M. Pitkänen. Crop Circles and Life at Parallel Space-Time Sheets. In *Magnetospheric Consciousness*. Onlinebook. [http://tgdtheory.com/public\\_html/magnconsc/magnconsc.html#crop2](http://tgdtheory.com/public_html/magnconsc/magnconsc.html#crop2), 2006.
- [K21] M. Pitkänen. Dark Forces and Living Matter. In *p-Adic Length Scale Hypothesis and Dark Matter Hierarchy*. Onlinebook. [http://tgdtheory.com/public\\_html/paddark/paddark.html#darkforces](http://tgdtheory.com/public_html/paddark/paddark.html#darkforces), 2006.
- [K22] M. Pitkänen. Dark Matter Hierarchy and Hierarchy of EEGs. In *TGD and EEG*. Onlinebook. [http://tgdtheory.com/public\\_html/tgdeeg/tgdeeg.html#eegdark](http://tgdtheory.com/public_html/tgdeeg/tgdeeg.html#eegdark), 2006.
- [K23] M. Pitkänen. Dark Nuclear Physics and Condensed Matter. In *p-Adic Length Scale Hypothesis and Dark Matter Hierarchy*. Onlinebook. [http://tgdtheory.com/public\\_html/paddark/paddark.html#exonuclear](http://tgdtheory.com/public_html/paddark/paddark.html#exonuclear), 2006.
- [K24] M. Pitkänen. DNA as Topological Quantum Computer. In *Genes and Memes*. Onlinebook. [http://tgdtheory.com/public\\_html/genememe/genememe.html#dnatqc](http://tgdtheory.com/public_html/genememe/genememe.html#dnatqc), 2006.
- [K25] M. Pitkänen. Does TGD Predict the Spectrum of Planck Constants? In *Towards M-Matrix*. Onlinebook. [http://tgdtheory.com/public\\_html/tgdquant/tgdquant.html#Planck](http://tgdtheory.com/public_html/tgdquant/tgdquant.html#Planck), 2006.
- [K26] M. Pitkänen. Evolution in Many-Sheeted Space-Time. In *Genes and Memes*. Onlinebook. [http://tgdtheory.com/public\\_html/genememe/genememe.html#prebio](http://tgdtheory.com/public_html/genememe/genememe.html#prebio), 2006.
- [K27] M. Pitkänen. General Ideas about Many-Sheeted Space-Time: Part I. In *Physics in Many-Sheeted Space-Time*. Onlinebook. [http://tgdtheory.com/public\\_html/tgdclass/tgdclass.html#topcond](http://tgdtheory.com/public_html/tgdclass/tgdclass.html#topcond), 2006.
- [K28] M. Pitkänen. General Theory of Qualia. In *Bio-Systems as Conscious Holograms*. Onlinebook. [http://tgdtheory.com/public\\_html/hologram/hologram.html#qualia](http://tgdtheory.com/public_html/hologram/hologram.html#qualia), 2006.
- [K29] M. Pitkänen. *Genes and Memes*. Onlinebook. [http://tgdtheory.com/public\\_html/genememe/genememe.html](http://tgdtheory.com/public_html/genememe/genememe.html), 2006.
- [K30] M. Pitkänen. Genes and Memes. In *Genes and Memes*. Onlinebook. [http://tgdtheory.com/public\\_html/genememe/genememe.html#genememec](http://tgdtheory.com/public_html/genememe/genememe.html#genememec), 2006.
- [K31] M. Pitkänen. Homeopathy in Many-Sheeted Space-Time. In *Bio-Systems as Conscious Holograms*. Onlinebook. [http://tgdtheory.com/public\\_html/hologram/hologram.html#homeoc](http://tgdtheory.com/public_html/hologram/hologram.html#homeoc), 2006.
- [K32] M. Pitkänen. Macro-Temporal Quantum Coherence and Spin Glass Degeneracy. In *Bio-Systems as Conscious Holograms*. Onlinebook. [http://tgdtheory.com/public\\_html/hologram/hologram.html#macro](http://tgdtheory.com/public_html/hologram/hologram.html#macro), 2006.
- [K33] M. Pitkänen. Macroscopic Quantum Coherence and Quantum Metabolism as Different Sides of the Same Coin. In *Bio-Systems as Conscious Holograms*. Onlinebook. [http://tgdtheory.com/public\\_html/hologram/hologram.html#metab](http://tgdtheory.com/public_html/hologram/hologram.html#metab), 2006.

- [K34] M. Pitkänen. Macroscopic Quantum Phenomena and  $CP_2$  Geometry. In *Physics in Many-Sheeted Space-Time*. Onlinebook. [http://tgdtheory.com/public\\_html/tgdclass/tgdclass.html#super](http://tgdtheory.com/public_html/tgdclass/tgdclass.html#super), 2006.
- [K35] M. Pitkänen. Magnetic Sensory Canvas Hypothesis. In *TGD and EEG*. Onlinebook. [http://tgdtheory.com/public\\_html//tgdeeg/tgdeeg/tgdeeg.html#mec](http://tgdtheory.com/public_html//tgdeeg/tgdeeg/tgdeeg.html#mec), 2006.
- [K36] M. Pitkänen. *Magnetospheric Consciousness*. Onlinebook. [http://tgdtheory.com/public\\_html/magnconsc/magnconsc.html](http://tgdtheory.com/public_html/magnconsc/magnconsc.html), 2006.
- [K37] M. Pitkänen. Magnetospheric Sensory Representations. In *Magnetospheric Consciousness*. Onlinebook. [http://tgdtheory.com/public\\_html/magnconsc/magnconsc.html#srepres](http://tgdtheory.com/public_html/magnconsc/magnconsc.html#srepres), 2006.
- [K38] M. Pitkänen. Many-Sheeted DNA. In *Genes and Memes*. Onlinebook. [http://tgdtheory.com/public\\_html/genememe/genememe.html#genecodec](http://tgdtheory.com/public_html/genememe/genememe.html#genecodec), 2006.
- [K39] M. Pitkänen. Massless states and particle massivation. In *p-Adic Length Scale Hypothesis and Dark Matter Hierarchy*. Onlinebook. [http://tgdtheory.com/public\\_html/paddark/paddark.html#mless](http://tgdtheory.com/public_html/paddark/paddark.html#mless), 2006.
- [K40] M. Pitkänen. *Mathematical Aspects of Consciousness Theory*. Onlinebook. [http://tgdtheory.com/public\\_html/mathconsc/mathconsc.html](http://tgdtheory.com/public_html/mathconsc/mathconsc.html), 2006.
- [K41] M. Pitkänen. Matter, Mind, Quantum. In *TGD Inspired Theory of Consciousness*. Onlinebook. [http://tgdtheory.com/public\\_html/tgdconsc/tgdconsc.html#conscic](http://tgdtheory.com/public_html/tgdconsc/tgdconsc.html#conscic), 2006.
- [K42] M. Pitkänen. Negentropy Maximization Principle. In *TGD Inspired Theory of Consciousness*. Onlinebook. [http://tgdtheory.com/public\\_html/tgdconsc/tgdconsc.html#nmpc](http://tgdtheory.com/public_html/tgdconsc/tgdconsc.html#nmpc), 2006.
- [K43] M. Pitkänen. New Particle Physics Predicted by TGD: Part I. In *p-Adic Length Scale Hypothesis and Dark Matter Hierarchy*. Onlinebook. [http://tgdtheory.com/public\\_html/paddark/paddark.html#mass4](http://tgdtheory.com/public_html/paddark/paddark.html#mass4), 2006.
- [K44] M. Pitkänen. Nuclear String Hypothesis. In *p-Adic Length Scale Hypothesis and Dark Matter Hierarchy*. Onlinebook. [http://tgdtheory.com/public\\_html/paddark/paddark.html#nuclstring](http://tgdtheory.com/public_html/paddark/paddark.html#nuclstring), 2006.
- [K45] M. Pitkänen. *p-Adic length Scale Hypothesis and Dark Matter Hierarchy*. Onlinebook. [http://tgdtheory.com/public\\_html/paddark/paddark.html](http://tgdtheory.com/public_html/paddark/paddark.html), 2006.
- [K46] M. Pitkänen. p-Adic Particle Massivation: Hadron Masses. In *p-Adic Length Scale Hypothesis and Dark Matter Hierarchy*. Onlinebook. [http://tgdtheory.com/public\\_html/paddark/paddark.html#mass3](http://tgdtheory.com/public_html/paddark/paddark.html#mass3), 2006.
- [K47] M. Pitkänen. p-Adic Physics as Physics of Cognition and Intention. In *TGD Inspired Theory of Consciousness*. Onlinebook. [http://tgdtheory.com/public\\_html/tgdconsc/tgdconsc.html#cognic](http://tgdtheory.com/public_html/tgdconsc/tgdconsc.html#cognic), 2006.
- [K48] M. Pitkänen. *Physics in Many-Sheeted Space-Time*. Onlinebook. [http://tgdtheory.com/public\\_html/tgdclass/tgdclass.html](http://tgdtheory.com/public_html/tgdclass/tgdclass.html), 2006.
- [K49] M. Pitkänen. Quantum Antenna Hypothesis. In *Quantum Hardware of Living Matter*. Onlinebook. [http://tgdtheory.com/public\\_html/bioware/bioware.html#tubuc](http://tgdtheory.com/public_html/bioware/bioware.html#tubuc), 2006.
- [K50] M. Pitkänen. Quantum Astrophysics. In *Physics in Many-Sheeted Space-Time*. Onlinebook. [http://tgdtheory.com/public\\_html/tgdclass/tgdclass.html#qastro](http://tgdtheory.com/public_html/tgdclass/tgdclass.html#qastro), 2006.
- [K51] M. Pitkänen. Quantum Control and Coordination in Bio-systems: Part I. In *Bio-Systems as Self-Organizing Quantum Systems*. Onlinebook. [http://tgdtheory.com/public\\_html/bioselforg/bioselforg.html#qcococI](http://tgdtheory.com/public_html/bioselforg/bioselforg.html#qcococI), 2006.
- [K52] M. Pitkänen. Quantum Control and Coordination in Bio-Systems: Part II. In *Bio-Systems as Self-Organizing Quantum Systems*. Onlinebook. [http://tgdtheory.com/public\\_html/bioselforg/bioselforg.html#qcococII](http://tgdtheory.com/public_html/bioselforg/bioselforg.html#qcococII), 2006.

- [K53] M. Pitkänen. *Quantum Hardware of Living Matter*. Onlinebook. [http://tgdtheory.com/public\\_html/bioware/bioware.html](http://tgdtheory.com/public_html/bioware/bioware.html), 2006.
- [K54] M. Pitkänen. Quantum Model for Hearing. In *TGD and EEG*. Onlinebook. [http://tgdtheory.com/public\\_html//tgdeeg/tgdeeg/tgdeeg.html#hearing](http://tgdtheory.com/public_html//tgdeeg/tgdeeg/tgdeeg.html#hearing), 2006.
- [K55] M. Pitkänen. Quantum Model for Nerve Pulse. In *TGD and EEG*. Onlinebook. [http://tgdtheory.com/public\\_html//tgdeeg/tgdeeg/tgdeeg.html#pulse](http://tgdtheory.com/public_html//tgdeeg/tgdeeg/tgdeeg.html#pulse), 2006.
- [K56] M. Pitkänen. Quantum Model for Paranormal Phenomena. In *TGD Inspired Theory of Consciousness*. Onlinebook. [http://tgdtheory.com/public\\_html/tgdconsc/tgdconsc.html#parac](http://tgdtheory.com/public_html/tgdconsc/tgdconsc.html#parac), 2006.
- [K57] M. Pitkänen. Quantum Model for Sensory Representations. In *TGD Inspired Theory of Consciousness*. Onlinebook. [http://tgdtheory.com/public\\_html/tgdconsc/tgdconsc.html#expc](http://tgdtheory.com/public_html/tgdconsc/tgdconsc.html#expc), 2006.
- [K58] M. Pitkänen. Quantum Model of EEG. In *TGD and EEG*. Onlinebook. [http://tgdtheory.com/public\\_html/tgdeeg/tgdeeg.html#eegII](http://tgdtheory.com/public_html/tgdeeg/tgdeeg.html#eegII), 2006.
- [K59] M. Pitkänen. Quantum Model of Memory. In *TGD Inspired Theory of Consciousness*. Onlinebook. [http://tgdtheory.com/public\\_html/tgdconsc/tgdconsc.html#memoryc](http://tgdtheory.com/public_html/tgdconsc/tgdconsc.html#memoryc), 2006.
- [K60] M. Pitkänen. *Quantum Physics as Infinite-Dimensional Geometry*. Onlinebook. [http://tgdtheory.com/public\\_html/tgdgeom/tgdgeom.html](http://tgdtheory.com/public_html/tgdgeom/tgdgeom.html), 2006.
- [K61] M. Pitkänen. *Quantum TGD*. Onlinebook. [http://tgdtheory.com/public\\_html/tgdquant/tgdquant.html](http://tgdtheory.com/public_html/tgdquant/tgdquant.html), 2006.
- [K62] M. Pitkänen. Quantum Theory of Self-Organization. In *Bio-Systems as Self-Organizing Quantum Systems*. Onlinebook. [http://tgdtheory.com/public\\_html/bioselforg/bioselforg.html#selforgac](http://tgdtheory.com/public_html/bioselforg/bioselforg.html#selforgac), 2006.
- [K63] M. Pitkänen. Semi-trance, Mental Illness, and Altered States of Consciousness. In *Magnetospheric Consciousness*. Onlinebook. [http://tgdtheory.com/public\\_html/magnconsc/magnconsc.html#semitrancec](http://tgdtheory.com/public_html/magnconsc/magnconsc.html#semitrancec), 2006.
- [K64] M. Pitkänen. Semitrance, Language, and Development of Civilization. In *Magnetospheric Consciousness*. Onlinebook. [http://tgdtheory.com/public\\_html/magnconsc/magnconsc.html#langsoc](http://tgdtheory.com/public_html/magnconsc/magnconsc.html#langsoc), 2006.
- [K65] M. Pitkänen. TGD and Astrophysics. In *Physics in Many-Sheeted Space-Time*. Onlinebook. [http://tgdtheory.com/public\\_html/tgdclass/tgdclass.html#astro](http://tgdtheory.com/public_html/tgdclass/tgdclass.html#astro), 2006.
- [K66] M. Pitkänen. TGD and Cosmology. In *Physics in Many-Sheeted Space-Time*. Onlinebook. [http://tgdtheory.com/public\\_html/tgdclass/tgdclass.html#cosmo](http://tgdtheory.com/public_html/tgdclass/tgdclass.html#cosmo), 2006.
- [K67] M. Pitkänen. *TGD and EEG*. Onlinebook. [http://tgdtheory.com/public\\_html/tgdeeg/tgdeeg.html](http://tgdtheory.com/public_html/tgdeeg/tgdeeg.html), 2006.
- [K68] M. Pitkänen. *TGD and Fringe Physics*. Onlinebook. [http://tgdtheory.com/public\\_html/freenergy/freenergy.html](http://tgdtheory.com/public_html/freenergy/freenergy.html), 2006.
- [K69] M. Pitkänen. TGD and Nuclear Physics. In *p-Adic Length Scale Hypothesis and Dark Matter Hierarchy*. Onlinebook. [http://tgdtheory.com/public\\_html/paddark/paddark.html#padnucl](http://tgdtheory.com/public_html/paddark/paddark.html#padnucl), 2006.
- [K70] M. Pitkänen. *TGD as a Generalized Number Theory*. Onlinebook. [http://tgdtheory.com/public\\_html/tgdnumber/tgdnumber.html](http://tgdtheory.com/public_html/tgdnumber/tgdnumber.html), 2006.
- [K71] M. Pitkänen. TGD as a Generalized Number Theory: p-Adicization Program. In *TGD as a Generalized Number Theory*. Onlinebook. [http://tgdtheory.com/public\\_html/tgdnumber/tgdnumber.html#visiona](http://tgdtheory.com/public_html/tgdnumber/tgdnumber.html#visiona), 2006.

- [K72] M. Pitkänen. TGD as a Generalized Number Theory: Quaternions, Octonions, and their Hyper Counterparts. In *TGD as a Generalized Number Theory*. Onlinebook. [http://tgdtheory.com/public\\_html/tgdnumber/tgdnumber.html#visionb](http://tgdtheory.com/public_html/tgdnumber/tgdnumber.html#visionb), 2006.
- [K73] M. Pitkänen. TGD Based Model for OBEs. In *TGD Inspired Theory of Consciousness*. Onlinebook. [http://tgdtheory.com/public\\_html/tgdconsc/tgdconsc.html#OBE](http://tgdtheory.com/public_html/tgdconsc/tgdconsc.html#OBE), 2006.
- [K74] M. Pitkänen. *TGD Inspired Theory of Consciousness*. Onlinebook. [http://tgdtheory.com/public\\_html/tgdconsc/tgdconsc.html](http://tgdtheory.com/public_html/tgdconsc/tgdconsc.html), 2006.
- [K75] M. Pitkänen. TGD Inspired Theory of Consciousness. In *Topological Geometrodynamics: Overview*. Onlinebook. [http://tgdtheory.com/public\\_html/tgdview/tgdview.html#tgdconsc2010](http://tgdtheory.com/public_html/tgdview/tgdview.html#tgdconsc2010), 2006.
- [K76] M. Pitkänen. The Notion of Free Energy and Many-Sheeted Space-Time Concept. In *TGD and Fringe Physics*. Onlinebook. [http://tgdtheory.com/public\\_html/freenergy/freenergy.html#freenergy](http://tgdtheory.com/public_html/freenergy/freenergy.html#freenergy), 2006.
- [K77] M. Pitkänen. The Relationship Between TGD and GRT. In *Physics in Many-Sheeted Space-Time*. Onlinebook. [http://tgdtheory.com/public\\_html/tgdclass/tgdclass.html#tgdgrt](http://tgdtheory.com/public_html/tgdclass/tgdclass.html#tgdgrt), 2006.
- [K78] M. Pitkänen. Three new physics realizations of the genetic code and the role of dark matter in bio-systems. In *Genes and Memes*. Onlinebook. [http://tgdtheory.com/public\\_html/genememe/genememe.html#dnatqccodes](http://tgdtheory.com/public_html/genememe/genememe.html#dnatqccodes), 2006.
- [K79] M. Pitkänen. Time, Spacetime and Consciousness. In *Bio-Systems as Conscious Holograms*. Onlinebook. [http://tgdtheory.com/public\\_html/hologram/hologram.html#time](http://tgdtheory.com/public_html/hologram/hologram.html#time), 2006.
- [K80] M. Pitkänen. *Topological Geometrodynamics: an Overview*. Onlinebook. [http://tgdtheory.com/public\\_html/tgdview/tgdview.html](http://tgdtheory.com/public_html/tgdview/tgdview.html), 2006.
- [K81] M. Pitkänen. Topological Quantum Computation in TGD Universe. In *Genes and Memes*. Onlinebook. [http://tgdtheory.com/public\\_html/genememe/genememe.html#tqc](http://tgdtheory.com/public_html/genememe/genememe.html#tqc), 2006.
- [K82] M. Pitkänen. Was von Neumann Right After All. In *Towards M-Matrix*. Onlinebook. [http://tgdtheory.com/public\\_html/tgdquant/tgdquant.html#vNeumann](http://tgdtheory.com/public_html/tgdquant/tgdquant.html#vNeumann), 2006.
- [K83] M. Pitkänen. Wormhole Magnetic Fields. In *Quantum Hardware of Living Matter*. Onlinebook. [http://tgdtheory.com/public\\_html/bioware/bioware.html#wormc](http://tgdtheory.com/public_html/bioware/bioware.html#wormc), 2006.



Part I

**THE RECENT VIEW ABOUT  
FIELD EQUATIONS**





## Chapter 2

# Basic Extremals of the Kähler Action

### 2.1 Introduction

In this chapter the classical field equations associated with the Kähler action are studied. The study of the extremals of the Kähler action has turned out to be extremely useful for the development of TGD. Towards the end of year 2003 quite dramatic progress occurred in the understanding of field equations and it seems that field equations might be in well-defined sense exactly solvable. The progress made during next five years led to a detailed understanding of quantum TGD at the fundamental parton level and this provides considerable additional insights concerning the interpretation of field equations.

#### 2.1.1 General considerations

The vanishing of Lorentz 4-force for the induced Kähler field means that the vacuum 4-currents are in a mechanical equilibrium. Lorentz 4-force vanishes for all known solutions of field equations which inspires the hypothesis that preferred extremals satisfy the condition. The vanishing of the Lorentz 4-force in turn implies a local conservation of the ordinary energy momentum tensor. The corresponding condition is implied by Einstein's equations in General Relativity. The hypothesis would mean that the solutions of field equations are what might be called generalized Beltrami fields. If Kähler action is defined by  $CP_2$  Kähler form alone, the condition implies that vacuum currents can be non-vanishing only provided the dimension  $D_{CP_2}$  of the  $CP_2$  projection of the space-time surface is less than four so that in the regions with  $D_{CP_2} = 4$ , Maxwell's vacuum equations are satisfied.

The hypothesis that Kähler current is proportional to a product of an arbitrary function  $\psi$  of  $CP_2$  coordinates and of the instanton current generalizes Beltrami condition and reduces to it when electric field vanishes. Instanton current has vanishing divergence for  $D_{CP_2} < 4$ , and Lorentz 4-force indeed vanishes. The remaining task would be the explicit construction of the imbeddings of these fields and the demonstration that field equations can be satisfied.

Under additional conditions magnetic field reduces to what is known as Beltrami field. Beltrami fields are known to be extremely complex but highly organized structures. The natural conjecture is that topologically quantized many-sheeted magnetic and  $Z^0$  magnetic Beltrami fields and their generalizations serve as templates for the helical molecules populating living matter, and explain both chirality selection, the complex linking and knotting of DNA and protein molecules, and even the extremely complex and self-organized dynamics of biological systems at the molecular level.

Field equations can be reduced to algebraic conditions stating that energy momentum tensor and second fundamental form have no common components (this occurs also for minimal surfaces in string models) and only the conditions stating that Kähler current vanishes, is light-like, or proportional to instanton current, remain and define the remaining field equations. The conditions guaranteeing topologization to instanton current can be solved explicitly. Solutions can be found also in the more general case when Kähler current is not proportional to instanton current. On basis of these findings there are strong reasons to believe that classical TGD is exactly solvable.

An important outcome is the notion of Hamilton-Jacobi structure meaning dual slicings of  $M^4$

projection of preferred extremals to string world sheets and partonic 2-surfaces. The necessity of this slicing was discovered years later from number theoretic compactification and is now a key element of quantum TGD allowing to deduce Equivalence Principle in its stringy form from quantum TGD and formulate and understand quantum TGD in terms of modified Dirac action assignable to Kähler action. The conservation of Noether charges associated with modified Dirac action requires the vanishing of the second second variation of Kähler action for preferred extremals - at least for the deformations generating dynamical symmetries. Preferred extremals would thus define space-time representation for quantum criticality. Infinite-dimensional variant for the hierarchy of criticalities analogous to the hierarchy assigned to the extrema of potential function with levels labeled by the rank of the matrix defined by the second derivatives of the potential function in catastrophe theory would suggest itself.

### 2.1.2 In what sense field equations mimic dissipative dynamics?

By quantum classical correspondence the non-deterministic space-time dynamics should mimic the dissipative dynamics of the quantum jump sequence. The nontrivial question is what this means in TGD framework.

1. Beltrami fields appear in physical applications as asymptotic self organization patterns for which Lorentz force and dissipation vanish. This suggests that preferred extremals of Kähler action correspond to space-time sheets which at least asymptotically satisfy generalized Beltrami conditions so that one can indeed assign to the final (rather than initial!) 3-surface a unique 4-surface apart from effects related to non-determinism. Preferred extremal property of Kähler action abstracted to purely algebraic generalized Beltrami conditions would make sense also in the p-adic context. The general solution ansatz discussed in the last section of the chapter assumes that all conserved isometry currents are proportional to instanton current so that various charges are conserved separately for all flow lines: this means essentially the integrability of the theory. This ansatz is forced by the hypothesis that TGD reduces to almost topological QFT and this idea. The basic consequence is that dissipation is impossible classically.
2. A more radical view inspired by zero energy ontology is that the light-like 3-surfaces and corresponding space-time regions with Euclidian signature defining generalized Feynman diagrams provide a space-time representation of dissipative dynamics just as they provide this representation in quantum field theory. Minkowskian regions would represent empty space so that the vanishing of Lorentz 4-force and absence of dissipation would be natural. This would mean very precise particle field duality and the topological pattern associated with the generalized Feynman diagram would represent dissipation. One could also interpret dissipation as transfer of energy between sheets of the many-sheeted space time and thus as an essentially topological phenomenon. This option seems to be the only viable one.

### 2.1.3 The dimension of $CP_2$ projection as classifier for the fundamental phases of matter

The dimension  $D_{CP_2}$  of  $CP_2$  projection of the space-time sheet encountered already in p-adic mass calculations classifies the fundamental phases of matter. For  $D_{CP_2} = 4$  empty space Maxwell equations hold true. The natural guess would be that this phase is chaotic and analogous to de-magnetized phase.  $D_{CP_2} = 2$  phase is analogous to ferromagnetic phase: highly ordered and relatively simple. It seems however that preferred extremals can correspond only to small perturbations of these extremals resulting by topological condensation of  $CP_2$  type vacuum extremals and through topological condensation to larger space-time sheets.  $D_{CP_2} = 3$  is the analog of spin glass and liquid crystal phases, extremely complex but highly organized by the properties of the generalized Beltrami fields. This phase could be seen as the boundary between chaos and order and corresponds to life emerging in the interaction of magnetic bodies with bio-matter. It is possible only in a finite temperature interval (note however the p-adic hierarchy of critical temperatures) and characterized by chirality just like life.

The original proposal was that  $D(CP_2) = 4$  phase is completely chaotic. This is not true if the reduction to almost topological QFT takes place. This phase must correspond to Maxwellian phase with a vanishing Kähler current as concluded already earlier. Various isometry currents are however

proportional to the instanton current and conserved along the flow lines of the instanton current whose flow parameter extends to a global coordinate. Hence a completely chaotic phase is not in question even in this case.

### 2.1.4 Specific extremals of Kähler action

The study of extremals of Kähler action represents more than decade old layer in the development of TGD.

1. The huge vacuum degeneracy is the most characteristic feature of Kähler action (any 4-surface having  $CP_2$  projection which is Legendre sub-manifold is vacuum extremal, Legendre sub-manifolds of  $CP_2$  are in general 2-dimensional). This vacuum degeneracy is behind the spin glass analogy and leads to the p-adic TGD. As found in the second part of the book, various particle like vacuum extremals also play an important role in the understanding of the quantum TGD.
2. The so called  $CP_2$  type vacuum extremals have finite, negative action and are therefore an excellent candidate for real particles whereas vacuum extremals with vanishing Kähler action are candidates for the virtual particles. These extremals have one dimensional  $M^4$  projection, which is light like curve but not necessarily geodesic and locally the metric of the extremal is that of  $CP_2$ : the quantization of this motion leads to Virasoro algebra. Space-times with topology  $CP_2 \# CP_2 \# \dots CP_2$  are identified as the generalized Feynmann diagrams with lines thickened to 4-manifolds of "thickness" of the order of  $CP_2$  radius. The quantization of the random motion with light velocity associated with the  $CP_2$  type extremals in fact led to the discovery of Super Virasoro invariance, which through the construction of the configuration space geometry, becomes a basic symmetry of quantum TGD.
3. There are also various non-vacuum extremals.
  - (a) String like objects, with string tension of same order of magnitude as possessed by the cosmic strings of GUTs, have a crucial role in TGD inspired model for the galaxy formation and in the TGD based cosmology.
  - (b) The so called massless extremals describe non-linear plane waves propagating with the velocity of light such that the polarization is fixed in given point of the space-time surface. The purely TGD:ish feature is the light like Kähler current: in the ordinary Maxwell theory vacuum gauge currents are not possible. This current serves as a source of coherent photons, which might play an important role in the quantum model of bio-system as a macroscopic quantum system.
  - (c) In the so called Maxwell's phase, ordinary Maxwell equations for the induced Kähler field are satisfied in an excellent approximation. A special case is provided by a radially symmetric extremal having an interpretation as the space-time exterior to a topologically condensed particle. The sign of the gravitational mass correlates with that of the Kähler charge and one can understand the generation of the matter antimatter asymmetry from the basic properties of this extremal. The possibility to understand the generation of the matter antimatter asymmetry directly from the basic equations of the theory gives strong support in favor of TGD in comparison to the ordinary EYM theories, where the generation of the matter antimatter asymmetry is still poorly understood.

### 2.1.5 The weak form of electric-magnetic duality and modification of Kähler action

The newest results discussed in the last section about the weak form of electric-magnetic duality suggest strongly that Beltrami property is general and together with the weak form of electric-magnetic duality allows a reduction of quantum TGD to almost topological field theory with Kähler function allowing expression as a Chern-Simons term.

Generalized Beltrami property leads to a rather explicit construction of the general solution of field equations based on the hydrodynamic picture implying that single particle quantum numbers are

conserved along flow lines defined by the instanton current. The construction generalizes also to the fermionic sector and there are reasons to hope that TGD is completely integrable theory.

## 2.2 General considerations

The solution families of field equations studied in this chapter were found already during eighties. The physical interpretation turned out to be the really tough problem. What is the principle selecting preferred extremals of Kähler action as analogs of Bohr orbits assigning to 3-surface  $X^3$  a unique space-time surface  $X^4(X^3)$ ? Does Equivalence Principle hold true and if so, in what sense? These have been the key questions. The realization that light-like 3-surfaces  $X_l^3$  associated with the light-like wormhole throats at which the signature of the induced metric changes from Minkowskian to Euclidian led to the formulation of quantum TGD in terms of second quantized induced spinor fields at these surfaces. Together with the notion of number theoretical compactification this approach allowed to identify the conditions characterizing the preferred extremals. What is remarkable that these conditions are consistent with what is known about extremals. Also a connection with string models and understanding of the space-time realization of Equivalence Principle emerged. In this section the theoretical background behind field equations is briefly summarized. I will not repeat the discussion of previous two chapters [K27, ?] summarizing the general vision about many-sheeted space-time, and consideration will be restricted to those aspects of vision leading to direct predictions about the properties of preferred extremals of Kähler action.

### 2.2.1 Number theoretical compactification and $M^8 - H$ duality

The notion of hyper-quaternionic and octonionic manifold makes sense but it not plausible that  $H = M^4 \times CP_2$  could be endowed with a hyper-octonionic manifold structure. Situation changes if  $H$  is replaced with hyper-octonionic  $M^8$ . Suppose that  $X^4 \subset M^8$  consists of hyper-quaternionic and co-hyper-quaternionic regions. The basic observation is that the hyper-quaternionic sub-spaces of  $M^8$  with a fixed hyper-complex structure (containing in their tangent space a fixed hyper-complex subspace  $M^2$  or at least one of the light-like lines of  $M^2$ ) are labeled by points of  $CP_2$ . Hence each hyper-quaternionic and co-hyper-quaternionic four-surface of  $M^8$  defines a 4-surface of  $M^4 \times CP_2$ . One can loosely say that the number-theoretic analog of spontaneous compactification occurs: this of course has nothing to do with dynamics.

This picture was still too naive and it became clear that not all known extremals of Kähler action contain fixed  $M^2 \subset M^4$  or light-like line of  $M^2$  in their tangent space.

1. The first option represents the minimal form of number theoretical compactification.  $M^8$  is interpreted as the tangent space of  $H$ . Only the 4-D tangent spaces of light-like 3-surfaces  $X_l^3$  (wormhole throats or boundaries) are assumed to be hyper-quaternionic or co-hyper-quaternionic and contain fixed  $M^2$  or its light-like line in their tangent space. Hyper-quaternionic regions would naturally correspond to space-time regions with Minkowskian signature of the induced metric and their co-counterparts to the regions for which the signature is Euclidian. What is of special importance is that this assumption solves the problem of identifying the boundary conditions fixing the preferred extremals of Kähler action since in the generic case the intersection of  $M^2$  with the 3-D tangent space of  $X_l^3$  is 1-dimensional. The surfaces  $X^4(X_l^3) \subset M^8$  would be hyper-quaternionic or co-hyper-quaternionic but would not allow a local mapping between the 4-surfaces of  $M^8$  and  $H$ .
2. One can also consider a more local map of  $X^4(X_l^3) \subset H$  to  $X^4(X_l^3) \subset M^8$ . The idea is to allow  $M^2 \subset M^4 \subset M^8$  to vary from point to point so that  $S^2 = SO(3)/SO(2)$  characterizes the local choice of  $M^2$  in the interior of  $X^4$ . This leads to a quite nice view about strong geometric form of  $M^8 - H$  duality in which  $M^8$  is interpreted as tangent space of  $H$  and  $X^4(X_l^3) \subset M^8$  has interpretation as tangent for a curve defined by light-like 3-surfaces at  $X_l^3$  and represented by  $X^4(X_l^3) \subset H$ . Space-time surfaces  $X^4(X_l^3) \subset M^8$  consisting of hyper-quaternionic and co-hyper-quaternionic regions would naturally represent a preferred extremal of  $E^4$  Kähler action. The value of the action would be same as  $CP_2$  Kähler action.  $M^8 - H$  duality would apply also at the induced spinor field and at the level of configuration space. The possibility to assign  $M^2(x) \subset M^4$  to each point of  $M^4$  projection  $P_{M^4}(X^4(X_l^3))$  is consistent with what is known

about extremals of Kähler action with only one exception:  $CP_2$  type vacuum extremals. In this case  $M^2$  can be assigned to the normal space.

3. Strong form of  $M^8 - H$  duality satisfies all the needed constraints if it represents Kähler isometry between  $X^4(X_l^3) \subset M^8$  and  $X^4(X_l^3) \subset H$ . This implies that light-like 3-surface is mapped to light-like 3-surface and induced metrics and Kähler forms are identical so that also Kähler action and field equations are identical. The only differences appear at the level of induced spinor fields at the light-like boundaries since due to the fact that gauge potentials are not identical.
4. The map of  $X_l^3 \subset H \rightarrow X_l^3 \subset M^8$  would be crucial for the realization of the number theoretical universality.  $M^8 = M^4 \times E^4$  allows linear coordinates as those preferred coordinates in which the points of imbedding space are rational/algebraic. Thus the point of  $X^4 \subset H$  is algebraic if it is mapped to algebraic point of  $M^8$  in number theoretic compactification. This of course restricts the symmetry groups to their rational/algebraic variants but this does not have practical meaning. Number theoretical compactification could thus be motivated by the number theoretical universality.
5. The possibility to use either  $M^8$  or  $H$  picture might be extremely useful for calculational purposes. In particular,  $M^8$  picture based on  $SO(4)$  gluons rather than  $SU(3)$  gluons could perturbative description of low energy hadron physics. The strong  $SO(4)$  symmetry of low energy hadron physics can be indeed seen direct experimental support for the  $M^8 - H$  duality.

Number theoretical compactification has quite deep implications for quantum TGD and is actually responsible for most of the progress in the understanding of the mathematical structure of quantum TGD. A very powerful prediction is that preferred extremals should allow slicings to either stringy world sheets or dual partonic 2-surfaces as well as slicing by light-like 3-surfaces. Both predictions are consistent with what is known about extremals.

1. If the distribution of planes  $M^2(x)$  is integrable, it is possible to slice  $X^4(X^3)$  to a union of 2-dimensional surfaces having interpretation as string world sheets and dual 2-dimensional copies of partonic surfaces  $X^2$ . This decomposition defining 2+2 Kaluza-Klein type structure realizes quantum gravitational holography and allows to understand Equivalence Principle at space-time level in the sense that dimensional reduction defined by the integral of Kähler action over the 2-dimensional space labeling stringy world sheets gives rise to the analog of stringy action and one obtains string model like description of quantum TGD as dual for a description based on light-like partonic 3-surfaces. String tension is not however equal to the inverse of gravitational constant as one might naively expect but the connection is more delicate.
2. Second implication is the slicing of  $X^4(X_l^3)$  to light-like 3-surfaces  $Y_l^3$  "parallel" to  $X_l^3$ . Also this slicing realizes quantum gravitational holography if one requires General Coordinate Invariance in the sense that the Dirac determinant defined by the generalized eigenvalues of the transverse part  $D_K(X^2)$  of  $D_K$  differs for two 3-surfaces  $Y_l^3$  in the slicing only by an exponent of a real part of a holomorphic function of configuration space complex coordinates giving no contribution to the Kähler metric. The requirement that the zero modes of the 4-D modified Dirac operators  $D_K$  reduce to the analogs of 3-D shock waves for all 3-surfaces  $Y_l^3$  in the slicing requires that Noether currents are parallel to  $Y_l^3$ . Clearly, 3+1 type Kaluza-Klein structure is in question. This slicing allows to realize RG flow at space-time level using the light-like coordinate associated with the slicing as RG parameter [?]. The prediction is RG invariance of couplings for a causal diamond ( $CD$ ) in given p-adic length scale meaning a justification of the hypothesis that coupling constant evolution reduces to a discrete p-adic coupling constant evolution with p-adic length scales coming as half octaves. This prediction follows if the known properties of extremals of Kähler action hold true quite generally.
3. The assumption that Kähler current and other gauge currents flow along the slices  $Y_l^3$  of the slicing of  $X^4(X_l^3)$  is enough for the renormalization group invariance of gauge couplings inside  $CD$  guaranteeing p-adic coupling constant evolution [?]. The current could thus have also a component parallel to the transverse cross section in which case the current would be space-like. Space-likeness brings in mind the Euclidian signature of the effective metric defined by the modified gamma matrices  $\hat{\Gamma}^\alpha = (\partial L_K / \partial h_\alpha^k) \gamma^k$  necessary for the Higgs mechanism. Dissipation

would be absent but Lorentz force would be non-vanishing. The general solution ansatz for the field equations allows besides light-like Kähler currents also space-like gauge currents, which can be regarded as topological currents. The gluing of  $CP_2$  type vacuum extremals to the known extremals with light-like gauge currents could generate the transversal part of the currents and increase the dimension  $D_{CP_2}$  of the  $CP_2$  projection to at least  $D_{CP_2} = 3$ .

### 2.2.2 The exponent of Kähler function as Dirac determinant for the modified Dirac action

Although quantum criticality in principle predicts the possible values of Kähler coupling strength, one might hope that there exists even more fundamental approach involving no coupling constants and predicting even quantum criticality and realizing quantum gravitational holography.

The identification of the light-like partonic 3-surfaces as carriers of elementary particle quantum numbers inspired by the TGD based quantum measurement theory suggests the identification of the modified Dirac action as that associated with the Chern-Simons action for the induced Kähler gauge potential. It however turned out that it is 4-D modified Dirac action associated with Kähler action, which is the correct choice. The point is that only the solutions of  $D_K$  which are effectively 3-dimensional by generalized super-conformal gauge invariance are physical. The effective metric defined by the modified gamma matrices is non-singular even for light-like 3-surfaces  $Y_l^3$ , and this allows to develop a well-defined theory involving also metric degrees of freedom. In this framework  $C - S$  action emerges as a phase factor of quantum states for phases with non-standard value of Planck constant and is related to anyons and charge fractionization.

Absolutely essential role is played by number theoretical compactification predicted that space-time sheets have dual slicings to string world sheets and partonic 2-surfaces. This prediction is supported by the properties of known extremals of Kähler action. This allows the decompositions  $D_K = D_K(Y^2) + D_K(X^2)$  generalized eigenvalues can be associated associated with  $D_K(X^2)$  for zero modes of  $D_K$ .

1. The Dirac determinant defined by the product of Dirac determinants associated with the light-like partonic 3-surfaces  $X_l^3$  associated with a given space-time sheet  $X^4$  is the simplest candidate for vacuum functional identifiable as the exponent of the Kähler function. One can of course worry about the finiteness of the Dirac determinant. p-Adicization requires that the eigenvalues belong to a given algebraic extension of rationals. This restriction would imply a hierarchy of physics corresponding to different extensions and could automatically imply the finiteness and algebraic number property of the Dirac determinants if only finite number of eigenvalues would contribute. The regularization would be performed by physics itself if this were the case.
- 2.
3. The basic problem has been how to feed in the information about the preferred extremal of Kähler action to the eigenvalue spectrum  $D_K(X^2)$  at light-like 3-surface  $X_l^3$ . The identification of the preferred extremal came possible via boundary conditions at  $X_l^3$  dictated by number theoretical compactification. The basic observation is that the Dirac equation associated with the 4-D Dirac operator  $D_K$  defined by Kähler action can be seen as a conservation law for a super current. By restricting the super current to flow along  $X_l^3$  by requiring that its normal component vanishes, one obtains a singular solution of 4-D modified Dirac equation restricted to  $X_l^3$ . The "energy" spectrum to the spectrum of eigenvalues for  $D_K(X^2)$  and the product of the eigenvalues defines the Dirac determinant in standard manner. Since the eigenmodes are restricted to those localized to regions of non-vanishing induced Kähler form, the number of eigen modes is finite and therefore also Dirac determinant is finite. The eigenvalues can be also algebraic numbers.
4. It remains to be proven that the product of eigenvalues gives rise to the exponent of Kähler action for the preferred extremal of Kähler action. At this moment the only justification for the conjecture is that this the only thing that one can imagine.
5. An additional bonus is precise definition of quantum criticality. The Noether currents associated with the modified Dirac action are conserved if its variation with respect to  $H$ -coordinates

vanishes. This means that the second variation of Kähler action varies. One can consider also a weaker form of quantum criticality in which case only the variations with respect to deformations defining the conserved currents are vanishing. This would give to a hierarchy of criticalities defined by the second variations of Kähler action. The vacuum degeneracy of Kähler action would be essential for the realization of quantum criticality and could correspond to a hierarchy of dynamical gauge symmetries characterizing finite measurement resolution suggested by the hierarchy of Jones inclusions [K25].

6. A long-standing conjecture has been that the zeros of Riemann Zeta are somehow relevant for quantum TGD. Riemann zeta is however naturally replaced Dirac zeta defined by the eigenvalues of  $D_K(X^2)$  and closely related to Riemann Zeta since the spectrum consists essentially for the cyclotron energy spectra for localized solutions region of non-vanishing induced Kähler magnetic field and hence is in good approximation integer valued up to some cutoff integer. In zero energy ontology the Dirac zeta function associated with these eigenvalues defines "square root" of thermodynamics assuming that the energy levels of the system in question are expressible as logarithms of the eigenvalues of the modified Dirac operator defining kind of fundamental constants. Critical points correspond to approximate zeros of Dirac zeta and if Kähler function vanishes at criticality as it indeed should, the thermal energies at critical points are in first order approximation proportional to zeros themselves so that a connection between quantum criticality and approximate zeros of Dirac zeta emerges.
7. The discretization induced by the number theoretic braids reduces the world of classical worlds to effectively finite-dimensional space and configuration space Clifford algebra reduces to a finite-dimensional algebra. The interpretation is in terms of finite measurement resolution represented in terms of Jones inclusion  $\mathcal{M} \subset \mathcal{N}$  of HFFs with  $\mathcal{M}$  taking the role of complex numbers. The finite-D quantum Clifford algebra spanned by fermionic oscillator operators is identified as a representation for the coset space  $\mathcal{N}/\mathcal{M}$  describing physical states modulo measurement resolution. In the sectors of generalized imbedding space corresponding to non-standard values of Planck constant quantum version of Clifford algebra is in question.

Concerning the understanding of preferred extremals, the basic prediction (assuming that Kähler gauge potential has no gauge part in  $M^4$ ) is that the  $CP_2$  projection of the light-like 3-surfaces is 3-dimensional for non-vacuum partons. One implication is that a very general family of cosmic string type solutions with 2-D  $CP_2$  projection cannot correspond to preferred extremals. If ideal cosmic strings were preferred extremals, the most general realization for the hierarchy of Planck constants in terms of a book like structure of the imbedding space would not be possible [K25]. Also massless extremals have 2-D  $CP_2$  projection and are excluded as preferred extremals. The interpretation is that the preferred extremals must be deformations of these extremals containing topologically condensed  $CP_2$  type vacuum extremals representing elementary particles and that these extremals provide only smoothed out representation of the actual physics. The general principle would be that matter is present only if light-like 3-surfaces at which the signature of the induced metric changes (light-like boundary components cannot be excluded but in this case gauge charges would vanish). That the interaction with a larger Minkowskian space-time sheet creates matter could be seen as a variant of Mach Principle.

### 2.2.3 Preferred extremal property as classical correlate for quantum criticality, holography, and quantum classical correspondence

The Noether currents assignable to the modified Dirac equation are conserved only if the first variation of the modified Dirac operator  $D_K$  defined by Kähler action vanishes. This is equivalent with the vanishing of the second variation of Kähler action -at least for the variations corresponding to dynamical symmetries having interpretation as dynamical degrees of freedom which are below measurement resolution and therefore effectively gauge symmetries. The weaker condition would mean that the inner product defined by the integral of  $D_\alpha \partial L_K / \partial h_\alpha^k \delta h^k$  over the space-time surface vanishes for the deformations defining dynamical symmetries but the field equations are not satisfied completely generally. The weaker condition would mean that the inner product defined by the integral of  $D_\alpha \partial L_K / \partial h_\alpha^k \delta h^k$  over the space-time surface vanishes for the deformations defining dynamical symmetries but the field equations are not satisfied completely generally.

The vanishing of the second variation in interior of  $X^4(X_l^3)$  is what corresponds exactly to quantum criticality so that the basic vision about quantum dynamics of quantum TGD would lead directly to a precise identification of the preferred extremals. Something which I should have noticed for more than decade ago! The question whether these extremals correspond to absolute minima remains however open.

The vanishing of second variations of preferred extremals -at least for deformations representing dynamical symmetries, suggests a generalization of catastrophe theory of Thom, where the rank of the matrix defined by the second derivatives of potential function defines a hierarchy of criticalities with the tip of bifurcation set of the catastrophe representing the complete vanishing of this matrix. In the recent case this theory would be generalized to infinite-dimensional context. There are three kind of variables now but quantum classical correspondence (holography) allows to reduce the types of variables to two.

1. The variations of  $X^4(X_l^3)$  vanishing at the intersections of  $X^4(X_l^3)$  with the light-like boundaries of causal diamonds  $CD$  would represent behavior variables. At least the vacuum extremals of Kähler action would represent extremals for which the second variation vanishes identically (the "tip" of the multi-furcation set).
2. The zero modes of Kähler function would define the control variables interpreted as classical degrees of freedom necessary in quantum measurement theory. By effective 2-dimensionality (or holography or quantum classical correspondence) meaning that the configuration space metric is determined by the data coming from partonic 2-surfaces  $X^2$  at intersections of  $X_l^3$  with boundaries of  $CD$ , the interiors of 3-surfaces  $X^3$  at the boundaries of  $CD$ s in rough sense correspond to zero modes so that there is indeed huge number of them. Also the variables characterizing 2-surface, which cannot be complexified and thus cannot contribute to the Kähler metric of configuration space represent zero modes. Fixing the interior of the 3-surface would mean fixing of control variables. Extremum property would fix the 4-surface and behavior variables if boundary conditions are fixed to sufficient degree.
3. The complex variables characterizing  $X^2$  would represent third kind of variables identified as quantum fluctuating degrees of freedom contributing to the configuration space metric. Quantum classical correspondence requires 1-1 correspondence between zero modes and these variables. This would be essentially holography stating that the 2-D "causal boundary"  $X^2$  of  $X^3(X^2)$  codes for the interior. Preferred extremal property identified as criticality condition would realize the holography by fixing the values of zero modes once  $X^2$  is known and give rise to the holographic correspondence  $X^2 \rightarrow X^3(X^2)$ . The values of behavior variables determined by extremization would fix then the space-time surface  $X^4(X_l^3)$  as a preferred extremal.
4. Clearly, the presence of zero modes would be absolutely essential element of the picture. Quantum criticality, quantum classical correspondence, holography, and preferred extremal property would all represent more or less the same thing. One must of course be very cautious since the boundary conditions at  $X_l^3$  involve normal derivative and might bring in delicacies forcing to modify the simplest heuristic picture.

The basic question is whether number theoretic view about preferred extremals imply absolute minimization or something analogous to it.

1. The number theoretic conditions defining preferred extremals are purely algebraic and make sense also p-adically and this is enough since p-adic variants of field equations make sense although the notion of Kähler action does not make sense as integral. Despite this the identification of the vacuum functional as exponent of Kähler function as Dirac determinant allows to define the exponent of Kähler function as a p-adic number [K15] .
2. The general objection against all extremization principles is that they do not make sense p-adically since p-adic numbers are not well-ordered.
3. These observations do not encourage the idea about equivalence of the two approaches. On the other hand, real and p-adic sectors are related by algebraic continuation and it could be quite enough if the equivalence were true in real context alone.



The finite-dimensional analogy allows to compare absolute minimization and criticality with each other.

1. Absolute minimization would select the branch of Thom's catastrophe surface with the smallest value of potential function for given values of control variables. In general this value would not correspond to criticality since absolute minimization says nothing about the values of control variables (zero modes).
2. Criticality forces the space-time surface to belong to the bifurcation set and thus fixes the values of control variables, that is the interior of 3-surface assignable to the partonic 2-surface, and realized holography. If the catastrophe has more than  $N = 3$  sheets, several preferred extremals are possible for given values of control variables fixing  $X^3(X^2)$  unless one assumes that absolute minimization or some other criterion is applied in the bifurcation set. In this sense absolute minimization might make sense in the real context and if the selection is between finite number of alternatives is in question, it should be possible carry out the selection in number theoretically universal manner.

### 2.2.4 Can one determine experimentally the shape of the space-time surface?

The question 'Can one determine experimentally the shape of the space-time surface?' does not relate directly to the topic of this chapter in technical sense, and the only excuse for its inclusion is the title of this section plus the fact that the general conceptual framework behind quantum TGD assumes an affirmative answer to this question. If physics were purely classical physics, operationalism in the strong sense of the word would require that one can experimentally determine the shape of the space-time as a surface of the imbedding space with arbitrary accuracy by measuring suitable classical observables. In quantum physics situation is considerably more complex and quantum effects are both a blessing and a curse.

#### Measuring classically the shape of the space-time surface

Consider first the purely classical situation to see what is involved.

1. All classical gauge fields are expressible in terms of  $CP_2$  coordinates and their space-time gradients so that the measurement of four field quantities with some finite resolution in some space-time volume could in principle give enough information to deduce the remaining field quantities. The requirement that space-time surface corresponds to an extremal of Kähler action gives a further strong consistency constraint and one can in principle test whether this constraint is satisfied. A highly over-determined system is in question.
2. The freedom to choose the space-time coordinates freely causes complications and it seems that one must be able to determine also the distances between the points at which the field quantities are determined. At purely classical Riemannian level this boils down to the measurement of the induced metric defining classical gravitational field. In macroscopic length scales one could base the approach to iterative procedure in which one starts from the assumption that the coordinates used are Minkowski coordinates and gravitational corrections are very weak.
3. The measurement of induced Kähler form in some space-time volume determines space-time surface only modulo canonical transformations of  $CP_2$  and isometries of the imbedding space. If one measures classical electromagnetic field, which is not canonical invariant in general case, with some precision, one can determine to what kind of surface space-time region corresponds apart from the action of the isometries of  $H$ .

#### Quantum measurement of the shape of the space-time surface

In practice the measurement of the shape of the space-time surface is necessarily a bootstrap procedure based on the model for space-time region and on the requirement of internal consistency. Many-sheeted space-time and quantum phenomena produce considerable complications but also provide universal measurement standards.

Consider first how quantum effects could help to measure classical fields and distances.

1. The measurement of distances by measuring first induced metric at each point of space-time sheet is rather unpractical procedure. Many-sheeted space-time however comes in rescue here. p-Adic length scale hypothesis provides a hierarchy of natural length scales and one can use p-adic length and time scales as natural units of length and time: space-time sheets serve as meter sticks. For instance, length measurement reduces in principle to a finite number of operations using various space-time sheets with standardized lengths given by p-adic length scales. Also various transition frequencies and corresponding wavelengths provide universal time and length units. Atomic clock provides a standard example of this kind of time unit. A highly nontrivial implication is the possibility to deduce the composition of distant star from its spectral lines. Without p-adic length scale hypothesis the scales for the mass spectra of the elementary particles would be variable and atomic spectra would vary from point to point in TGD universe.

Do the p-adic length scales correspond to the length units of the induced metric or of  $M_+^4$  metric? If the topological condensation a meter stick space-time sheet at a larger space-time sheet does not stretch the meter stick but only bends it, the length topologically condensed meter stick in the induced metric equals to its original length measured using  $M_+^4$  metric.

2. If superconducting order parameters are expressible in terms of the  $CP_2$  coordinates (there is evidence for this, see the chapter "Macroscopic quantum phenomena and  $CP_2$  geometry"), one might determine directly the  $CP_2$  coordinates as functions of Minkowski coordinates and this would allow to estimate all classical fields directly and thus to deduce strong consistency constraints.
3. At quantum level only the fluxes of the classical fields through surface areas with some minimum size determined by the length scale resolution can be measured. In case of magnetic fields the quantization of the magnetic flux simplifies the situation dramatically. Topological field quantization quite generally modifies the measurement of continuous field variables to the measurement of fluxes. Interestingly, the construction of the configuration space geometry uses as configuration space coordinates various electric and magnetic fluxes over 2-dimensional cross sections of 3-surface.

Quantum effects introduce also difficulties and restrictions.

1. Canonical transformations localized with respect to the boundary of the light cone or more general light like surfaces act as isometries of the configuration space and one can determine the space-time surface only modulo these isometries. Even more, only the values of the non-quantum fluctuating zero modes characterizing the shape and size of the space-time surface are measurable with arbitrary precision in quantum theory. At the level of conscious experience quantum fluctuating degrees of freedom correspond to sensory qualia like color having no classical geometric content.
2. Space-time surface is replaced by a new one in each quantum jump (or rather the superposition of perceptively equivalent space-time surfaces). Only in the approximation that the change of the space-time region in single quantum jump is negligible, the measurement of the shape of space-time surface makes sense. The physical criterion for this is that dissipation is negligible. The change of the space-time region in single quantum jump can indeed be negligible if the measurement is performed with a finite resolution.
3. Conscious experience of self is an average over quantum jumps defining moments of consciousness. In particular, only the average increment of the zero modes is experienced and this means that one cannot fix the space-time surface apart from canonical transformation affecting the zero modes. Again the notion of measurement resolution comes in rescue.
4. The possibility of coherent states of photons and gravitons brings in a further quantum complication since the effective classical em and gravitational fields are superpositions of classical field and the order parameter describing the coherent state. In principle the extremely strong constraints between the classical field quantities allow to measure both the order parameters of the coherent phases and classical fields.

### Quantum holography and the shape of the space-time surface

If the Dirac determinant associated with the generalized eigenvalue spectrum of the modified Dirac operator  $D_K(X^2)$  indeed codes for Kähler action of a preferred extremal, it is fair to say that a lot of information about the shape of the space-time surface is coded to physical observables, which eigenvalues indeed represent. Quantum gravitational holography due to the Bohr orbit like character of space-time surface reduces the amount of information needed. Only a finite number of eigenvalues is involved and the eigen modes are associated with the 3-D light-like wormhole throats rather than with the space-time surface itself. If the eigenvalues were known or could be measured with infinite accuracy, one could in principle fix the boundary conditions at  $X_l^3$  and solve field equations determining the preferred extremal of Kähler action.

What is of course needed is the complete knowledge of the light-like 3-surfaces  $X_l^3$ . Needless to say, in practice a complete knowledge of  $X_l^3$  is impossible since measurement resolution is finite. The notion number theoretic braid provides a precise realization for the finite measurement accuracy at space-time level. At the level of configuration space spinors fields (world of classical worlds) just the fact that the number of eigenvalues is finite is correlate for the finite measurement accuracy. Furthermore, quantum states are actually quantum superpositions of 3-surfaces, which means that one can only speak about quantum average space-time surface for which the phase factors coding for the quantum numbers of elementary particles assigned to the strands of number theoretic braids are stationary so that correlation of classical gauge charges with quantum gauge charges is obtained.

## 2.3 General view about field equations

In this section field equations are deduced and discussed in general level. The fact that the divergence of the energy momentum tensor, Lorentz 4-force, does not vanish in general, in principle makes possible the mimicry of even dissipation and of the second law. For asymptotic self organization patterns for which dissipation is absent the Lorentz 4-force must vanish. This condition is guaranteed if Kähler current is proportional to the instanton current in the case that  $CP_2$  projection of the space-time sheet is smaller than four and vanishes otherwise. An attractive identification for the vanishing of Lorentz 4-force is as a condition equivalent with the selection of preferred extremal of Kähler action. If preferred extremals correspond to absolute minima this principle would be essentially equivalent with the second law of thermodynamics.

### 2.3.1 Field equations

The requirement that Kähler action is stationary leads to the following field equations in the interior of the four-surface

$$\begin{aligned} D_\beta(T^{\alpha\beta}h_\alpha^k) - j^\alpha J_l^k \partial_\alpha h^l &= 0 \ , \\ T^{\alpha\beta} &= J^{\nu\alpha} J_\nu^\beta - \frac{1}{4} g^{\alpha\beta} J^{\mu\nu} J_{\mu\nu} \ . \end{aligned} \quad (2.3.1)$$

Here  $T^{\alpha\beta}$  denotes the traceless canonical energy momentum tensor associated with the Kähler action. An equivalent form for the first equation is

$$\begin{aligned} T^{\alpha\beta} H_{\alpha\beta}^k - j^\alpha (J_\alpha^\beta h_\beta^k + J_l^k \partial_\alpha h^l) &= 0 \ . \\ H_{\alpha\beta}^k &= D_\beta \partial_\alpha h^k \ . \end{aligned} \quad (2.3.2)$$

$H_{\alpha\beta}^k$  denotes the components of the second fundamental form and  $j^\alpha = D_\beta J^{\alpha\beta}$  is the gauge current associated with the Kähler field.

On the boundaries of  $X^4$  and at wormhole throats the field equations are given by the expression

$$\frac{\partial L_K}{\partial_n h^k} = T^{n\beta} \partial_\beta h^k - J^{n\alpha} (J_\alpha^\beta \partial_\beta h^k + J_l^k \partial_\alpha h^l) = 0 \ . \quad (2.3.3)$$

At wormhole throats problems are caused by the vanishing of metric determinant implying that contravariant metric is singular.

For  $M^4$  coordinates boundary conditions are satisfied if one assumes

$$T^{n\beta} = 0 \quad (2.3.4)$$

stating that there is no flow of four-momentum through the boundary component or wormhole throat. This means that there is no energy exchange between Euclidian and Minkowskian regions so that Euclidian regions provide representations for particles as autonomous units. This is in accordance with the general picture [?]. Note that momentum transfer with external world necessarily involves generalized Feynman diagrams also at classical level.

For  $CP_2$  coordinates the boundary conditions are more delicate. The construction of configuration space spinor structure [K15] led to the conditions

$$g_{ni} = 0, \quad J_{ni} = 0. \quad (2.3.5)$$

$J^{ni} = 0$  does not and should not follow from this condition since contravariant metric is singular. It seems that limiting procedure is necessary in order to see what comes out.

The condition that Kähler electric charge defined as a gauge flux is non-vanishing would require that the quantity  $J^{nr}\sqrt{g}$  is finite (here  $r$  refers to the light-like coordinate of  $X_l^3$ ). Also  $g^{nr}\sqrt{g_4}$  which is analogous to gravitational flux if  $n$  is interpreted as time coordinate could be non-vanishing. These conditions are consistent with the above condition if one has

$$\begin{aligned} J_{ni} = 0, \quad g_{ni} = 0, \quad J_{ir} = 0, \quad g_{ir} = 0, \\ J^{nk} = 0 \quad k \neq r, \quad g^{nk} = 0 \quad k \neq r, \quad J^{nr}\sqrt{g_4} \neq 0, \quad g^{nr}\sqrt{g_4} \neq 0. \end{aligned} \quad (2.3.6)$$

The interpretation of this conditions is rather transparent.

1. The first two conditions state that covariant form of the induced Kähler electric field is in direction normal to  $X_l^3$  and metric separate into direct sum of normal and tangential contributions. Fifth and sixth condition state the same in contravariant form for  $k \neq n$ .
2. Third and fourth condition state that the induced Kähler field at  $X_l^3$  is purely magnetic and that the metric of  $x_l^3$  reduces to a block diagonal form. The reduction to purely magnetic field is of obvious importance as far as the understanding of the generalized eigen modes of the modified Dirac operator is considered [K15].
3. The last two conditions must be understood as a limit and  $\neq$  means only the possibility of non-vanishing Kähler gauge flux or analog of gravitational flux through  $X_l^3$ .
4. The vision inspired by number theoretical compactification allows to identify  $r$  and  $n$  in terms of the light-like coordinates assignable to an integrable distribution of planes  $M^2(x)$  assumed to be assignable to  $M^4$  projection of  $X^4(X_l^3)$ . Later it will be found that Hamilton-Jacobi structure assignable to the extremals indeed means the existence of this kind of distribution meaning slicing of  $X^4(X_l^3)$  both by string world sheets and dual partonic 2-surfaces as well as by light-like 3-surfaces  $Y_l^3$ .
5. The physical analogy for the situation is the surface of an ideal conductor. It would not be surprising that these conditions are satisfied by all induced gauge fields.

### 2.3.2 Topologization and light-likeness of the Kähler current as alternative manners to guarantee vanishing of Lorentz 4-force

The general solution of 4-dimensional Einstein-Yang Mills equations in Euclidian 4-metric relies on self-duality of the gauge field, which topologizes gauge charge. This topologization can be achieved by a weaker condition, which can be regarded as a dynamical generalization of the Beltrami condition. An alternative manner to achieve vanishing of the Lorentz 4-force is light-likeness of the Kähler 4-current. This does not require topologization.

### Topologization of the Kähler current for $D_{CP_2} = 3$ : covariant formulation

The condition states that Kähler 4-current is proportional to the instanton current whose divergence is instanton density and vanishes when the dimension of  $CP_2$  projection is smaller than four:  $D_{CP_2} < 4$ . For  $D_{CP_2} = 2$  the instanton 4-current vanishes identically and topologization is equivalent with the vanishing of the Kähler current.

If the simplest vision about light-like 3-surfaces as basic dynamical objects is accepted  $D_{CP_2} = 2$ , corresponds to a non-physical situation and only the deformations of these surfaces - most naturally resulting by gluing of  $CP_2$  type vacuum extremals on them - can represent preferred extremals of Kähler action. One can however speak about  $D_{CP_2} = 2$  phase if 4-surfaces are obtained are obtained in this manner.

$$j^\alpha \equiv D_\beta J^{\alpha\beta} = \psi \times j_I^\alpha = \psi \times \epsilon^{\alpha\beta\gamma\delta} J_{\beta\gamma} A_\delta . \quad (2.3.7)$$

Here the function  $\psi$  is an arbitrary function  $\psi(s^k)$  of  $CP_2$  coordinates  $s^k$  regarded as functions of space-time coordinates. It is essential that  $\psi$  depends on the space-time coordinates through the  $CP_2$  coordinates only. Hence the representation as an imbedded gauge field is crucial element of the solution ansatz.

The field equations state the vanishing of the divergence of the 4-current. This is trivially true for instanton current for  $D_{CP_2} < 4$ . Also the contraction of  $\nabla\psi$  (depending on space-time coordinates through  $CP_2$  coordinates only) with the instanton current is proportional to the winding number density and therefore vanishes for  $D_{CP_2} < 4$ .

The topologization of the Kähler current guarantees the vanishing of the Lorentz 4-force. Indeed, using the self-duality condition for the current, the expression for the Lorentz 4-force reduces to a term proportional to the instanton density:

$$\begin{aligned} j^\alpha J_{\alpha\beta} &= \psi \times j_I^\alpha J_{\alpha\beta} \\ &= \psi \times \epsilon^{\alpha\mu\nu\delta} J_{\mu\nu} A_\delta J_{\alpha\beta} . \end{aligned} \quad (2.3.8)$$

Since all vector quantities appearing in the contraction with the four-dimensional permutation tensor are proportional to the gradients of  $CP_2$  coordinates, the expression is proportional to the instanton density, and thus winding number density, and vanishes for  $D_{CP_2} < 4$ .

Remarkably, the topologization of the Kähler current guarantees also the vanishing of the term  $j^\alpha J^{k\iota} \partial_\alpha s^k$  in the field equations for  $CP_2$  coordinates. This means that field equations reduce in both  $M_+^4$  and  $CP_2$  degrees of freedom to

$$T^{\alpha\beta} H_{\alpha\beta}^k = 0 . \quad (2.3.9)$$

These equations differ from the equations of minimal surface only by the replacement of the metric tensor with energy momentum tensor. The earlier proposal that quaternion conformal invariance in a suitable sense might provide a general solution of the field equations could be seen as a generalization of the ordinary conformal invariance of string models. If the topologization of the Kähler current implying effective dimensional reduction in  $CP_2$  degrees of freedom is consistent with quaternion conformal invariance, the quaternion conformal structures must differ for the different dimensions of  $CP_2$  projection.

### Topologization of the Kähler current for $D_{CP_2} = 3$ : non-covariant formulation

In order to gain a concrete understanding about what is involved it is useful to repeat these arguments using the 3-dimensional notation. The components of the instanton 4-current read in three-dimensional notation as

$$\vec{j}_I = \vec{E} \times \vec{A} + \phi \vec{B} , \quad \rho_I = \vec{B} \cdot \vec{A} . \quad (2.3.10)$$

The self duality conditions for the current can be written explicitly using 3-dimensional notation and read

$$\begin{aligned}\nabla \times \bar{B} - \partial_t \bar{E} &= \bar{j} = \psi \bar{j}_I = \psi (\phi \bar{B} + \bar{E} \times \bar{A}) \quad , \\ \nabla \cdot \bar{E} &= \rho = \psi \rho_I \quad .\end{aligned}\tag{2.3.11}$$

For a vanishing electric field the self-duality condition for Kähler current reduces to the Beltrami condition

$$\nabla \times \bar{B} = \alpha \bar{B} \quad , \quad \alpha = \psi \phi \quad .\tag{2.3.12}$$

The vanishing of the divergence of the magnetic field implies that  $\alpha$  is constant along the field lines of the flow. When  $\phi$  is constant and  $\bar{A}$  is time independent, the condition reduces to the Beltrami condition with  $\alpha = \phi = \text{constant}$ , which allows an explicit solution [?].

One can check also the vanishing of the Lorentz 4-force by using 3-dimensional notation. Lorentz 3-force can be written as

$$\rho_I \bar{E} + \bar{j} \times \bar{B} = \psi \bar{B} \cdot \bar{A} \bar{E} + \psi (\bar{E} \times \bar{A} + \phi \bar{B}) \times \bar{B} = 0 \quad .\tag{2.3.13}$$

The fourth component of the Lorentz force reads as

$$\bar{j} \cdot \bar{E} = \psi \bar{B} \cdot \bar{E} + \psi (\bar{E} \times \bar{A} + \phi \bar{B}) \cdot \bar{E} = 0 \quad .\tag{2.3.14}$$

The remaining conditions come from the induction law of Faraday and could be guaranteed by expressing  $\bar{E}$  and  $\bar{B}$  in terms of scalar and vector potentials.

The density of the Kähler electric charge of the vacuum is proportional to the the helicity density of the so called helicity charge  $\rho = \psi \rho_I = \psi \bar{B} \cdot \bar{A}$ . This charge is topological charge in the sense that it does not depend on the induced metric at all. Note the presence of arbitrary function  $\psi$  of  $CP_2$  coordinates.

Further conditions on the functions appearing in the solution ansatz come from the 3 independent field equations for  $CP_2$  coordinates. What is remarkable that the generalized self-duality condition for the Kähler current allows to understand the general features of the solution ansatz to very high degree without any detailed knowledge about the detailed solution. The question whether field equations allow solutions consistent with the self duality conditions of the current will be dealt later. The optimistic guess is that the field equations and topologization of the Kähler current relate to each other very intimately.

### Vanishing or light likeness of the Kähler current guarantees vanishing of the Lorentz 4-force for $D_{CP_2} = 2$

For  $D_{CP_2} = 2$  one can always take two  $CP_2$  coordinates as space-time coordinates and from this it is clear that instanton current vanishes so that topologization gives a vanishing Kähler current. In particular, the Beltrami condition  $\nabla \times \bar{B} = \alpha \bar{B}$  is not consistent with the topologization of the instanton current for  $D_{CP_2} = 2$ .

$D_{CP_2} = 2$  case can be treated in a coordinate invariant manner by using the two coordinates of  $CP_2$  projection as space-time coordinates so that only a magnetic or electric field is present depending on whether the gauge current is time-like or space-like. Light-likeness of the gauge current provides a second manner to achieve the vanishing of the Lorentz force and is realized in case of massless extremals having  $D_{CP_2} = 2$ : this current is in the direction of propagation whereas magnetic and electric fields are orthogonal to it so that Beltrami conditions is certainly not satisfied.

### Under what conditions topologization of Kähler current yields Beltrami conditions?

Topologization of the Kähler 4-current gives rise to magnetic Beltrami fields if either of the following conditions is satisfied.

1. The  $\overline{E} \times \overline{A}$  term contributing besides  $\phi \overline{B}$  term to the topological current vanishes. This requires that  $\overline{E}$  and  $\overline{A}$  are parallel to each other

$$\overline{E} = \nabla \Phi - \partial_t \overline{A} = \beta \overline{A} \quad (2.3.15)$$

This condition is analogous to the Beltrami condition. Now only the 3-space has as its coordinates time coordinate and two spatial coordinates and  $\overline{B}$  is replaced with  $\overline{A}$ . Since  $E$  and  $B$  are orthogonal, this condition implies  $\overline{B} \cdot \overline{A} = 0$  so that Kähler charge density is vanishing.

2. The vector  $\overline{E} \times \overline{A}$  is parallel to  $\overline{B}$ .

$$\overline{E} \times \overline{A} = \beta \overline{B} \quad (2.3.16)$$

The condition is consistent with the orthogonality of  $\overline{E}$  and  $\overline{B}$  but implies the orthogonality of  $\overline{A}$  and  $\overline{B}$  so that electric charge density vanishes

In both cases vector potential fails to define a contact structure since  $B \cdot A$  vanishes (contact structures are discussed briefly below), and there exists a global coordinate along the field lines of  $\overline{A}$  and the full contact structure is lost again. Note however that the Beltrami condition for magnetic field means that magnetic field defines a contact structure irrespective of whether  $\overline{B} \cdot \overline{A}$  vanishes or not. The transition from the general case to Beltrami field would thus involve the replacement

$$(\overline{A}, \overline{B}) \rightarrow_{\nabla \times} (\overline{B}, \overline{j})$$

induced by the rotor.

One must of course take these considerations somewhat cautiously since the inner product depends on the induced 4-metric and it might be that induced metric could allow small vacuum charge density and make possible genuine contact structure.

### Hydrodynamic analogy

The field equations of TGD are basically hydrodynamic equations stating the local conservation of the currents associated with the isometries of the imbedding space. Therefore it is intriguing that Beltrami fields appear also as solutions of ideal magnetohydrodynamics equations and as steady solutions of non-viscous incompressible flow described by Euler equations [?].

In hydrodynamics the role of the magnetic field is taken by the velocity field. This raises the idea that the incompressible flow could occur along the field lines of some natural vector field. The considerations of the last section show that the instanton current defines a universal candidate as far as the general solution of the field equations is considered. All conserved currents defined by the isometry charges would be parallel to the instanton current: one can say each flow line of instanton current is a carrier of conserved quantum numbers. Perhaps even the flow lines of an incompressible hydrodynamic flow could in reasonable approximation correspond to those of instanton current.

The conservation laws are satisfied for each flow line separately and therefore it seems that one cannot have the analog of viscous hydrodynamic flow in this framework. On the other hand, quantum classical correspondence requires that also dissipative effects have space-time correlates. Does something go badly wrong?

One must however take this argument with a grain of salt. Dissipation, that is the transfer of conserved quantities to degrees of freedom corresponding to shorter scales, could correspond to a transfer of these quantities between different space-time sheets of the many-sheeted space-time. Here the opponent could however argue that larger space-time sheets mimic the dissipative dynamics in shorter scales and that classical currents represent "symbolically" averaged currents in shorter length scales, and that the local non-conservation of energy momentum tensor consistent with local conservation of isometry currents provides a unique manner to mimic the dissipative dynamics.

An argument allowing to circumvent the objection in a more convincing manner emerged more than decade after the emergence of the interpretation in terms of asymptotic self-organization patterns [K15, ?].

1. The construction of quantum TGD through second quantization of the modified Dirac equation led through several twists to the realization that the addition of a 3-dimensional measurement interaction term to the modified Dirac action is necessary in order to have quantum classical correspondence in the sense that the preferred extremals depend on the quantum numbers labeling states of super-conformal representations. Among many other things this also guarantees that the fermionic propagator has stringy character.
2. This term characterizes measurement interaction inducing state function reductions and hence also dissipation. It induces to a Kähler function a term which is real part of a holomorphic function of complex coordinates of the configuration space ("world of classical worlds") and a priori arbitrary function of zero modes and does not therefore contribute to the Kähler metric of configuration space. Kähler action is however affected by a term describing at space-time level the measurement interaction so that extremals do not remain the same.
3. Dissipation is absent in space-time regions where the measurement interaction term vanishes and there are good reasons to expect that also Kähler action reduces to Kähler action. Therefore preferred extremals can be interpreted as space-time correlates for asymptotic self-organization patterns.

### The stability of generalized Beltrami fields

The stability of generalized Beltrami fields is of high interest since unstable points of space-time sheets are those around which macroscopic changes induced by quantum jumps are expected to be localized.

#### 1. Contact forms and contact structures

The stability of Beltrami flows has been studied using the theory of contact forms in three-dimensional Riemann manifolds [?]. Contact form is a one-form  $A$  (that is covariant vector field  $A_\alpha$ ) with the property  $A \wedge dA \neq 0$ . In the recent case the induced Kähler gauge potential  $A_\alpha$  and corresponding induced Kähler form  $J_{\alpha\beta}$  for any 3-sub-manifold of space-time surface define a contact form so that the vector field  $A^\alpha = g^{\alpha\beta} A_\beta$  is not orthogonal with the magnetic field  $B^\alpha = \epsilon^{\alpha\beta\gamma} J_{\beta\gamma}$ . This requires that magnetic field has a helical structure. Induced metric in turn defines the Riemann structure.

If the vector potential defines a contact form, the charge density associated with the topologized Kähler current must be non-vanishing. This can be seen as follows.

1. The requirement that the flow lines of a one-form  $X_\mu$  defined by the vector field  $X^\mu$  as its dual allows to define a global coordinate  $x$  varying along the flow lines implies that there is an integrating factor  $\phi$  such that  $\phi X = dx$  and therefore  $d(\phi X) = 0$ . This implies  $d \log(\phi) \wedge X = -dX$ . From this the necessary condition for the existence of the coordinate  $x$  is  $X \wedge dX = 0$ . In the three-dimensional case this gives  $\bar{X} \cdot (\nabla \times \bar{X}) = 0$ .
2. This condition is by definition not satisfied by the vector potential defining a contact form so that one cannot identify a global coordinate varying along the flow lines of the vector potential. The condition  $\bar{B} \cdot \bar{A} \neq 0$  states that the charge density for the topologized Kähler current is non-vanishing. The condition that the field lines of the magnetic field allow a global coordinate requires  $\bar{B} \cdot \nabla \times \bar{B} = 0$ . The condition is not satisfied by Beltrami fields with  $\alpha \neq 0$ . Note that in this case magnetic field defines a contact structure.

Contact structure requires the existence of a vector  $\xi$  satisfying the condition  $A(\xi) = 0$ . The vector field  $\xi$  defines a plane field, which is orthogonal to the vector field  $A^\alpha$ . Reeb field in turn is a vector field for which  $A(X) = 1$  and  $dA(X; \cdot) = 0$  hold true. The latter condition states the vanishing of the cross product  $X \times B$  so that  $X$  is parallel to the Kähler magnetic field  $B^\alpha$  and has unit projection in the direction of the vector field  $A^\alpha$ . Any Beltrami field defines a Reeb field irrespective of the Riemannian structure.

#### 2. Stability of the Beltrami flow and contact structures

Contact structures are used in the study of the topology and stability of the hydrodynamical flows [?], and one might expect that the notion of contact structure and its proper generalization to the four-dimensional context could be useful in TGD framework also. An example giving some idea



about the complexity of the flows defined by Beltrami fields is the Beltrami field in  $R^3$  possessing closed orbits with all possible knot and link types simultaneously [?] !

Beltrami flows associated with Euler equations are known to be unstable [?] . Since the flow is volume preserving, the stationary points of the Beltrami flow are saddle points at which also vorticity vanishes and linear instabilities of Navier-Stokes equations can develop. From the point of view of biology it is interesting that the flow is stabilized by vorticity which implies also helical structures. The stationary points of the Beltrami flow correspond in TGD framework to points at which the induced Kähler magnetic field vanishes. They can be unstable by the vacuum degeneracy of Kähler action implying classical non-determinism. For generalized Beltrami fields velocity and vorticity (both divergence free) are replaced by Kähler current and instanton current.

More generally, the points at which the Kähler 4-current vanishes are expected to represent potential instabilities. The instanton current is linear in Kähler field and can vanish in a gauge invariant manner only if the induced Kähler field vanishes so that the instability would be due to the vacuum degeneracy also now. Note that the vanishing of the Kähler current allows also the generation of region with  $D_{CP_2} = 4$ . The instability of the points at which induce Kähler field vanish is manifested in quantum jumps replacing the generalized Beltrami field with a new one such that something new is generated around unstable points. Thus the regions in which induced Kähler field becomes weak are the most interesting ones. For example, unwinding of DNA could be initiated by an instability of this kind.

### 2.3.3 How to satisfy field equations?

The topologization of the Kähler current guarantees also the vanishing of the term  $j^\alpha J^{k\iota} \partial_\alpha s^k$  in the field equations for  $CP_2$  coordinates. This means that field equations reduce in both  $M_+^4$  and  $CP_2$  degrees of freedom to

$$T^{\alpha\beta} H_{\alpha\beta}^k = 0 . \quad (2.3.17)$$

These equations differ from the equations of minimal surface only by the replacement of the metric tensor with energy momentum tensor. The following approach utilizes the properties of Hamilton Jacobi structures of  $M_+^4$  introduced in the study of massless extremals and contact structures of  $CP_2$  emerging naturally in the case of generalized Beltrami fields.

#### String model as a starting point

String model serves as a starting point.

1. In the case of Minkowskian minimal surfaces representing string orbit the field equations reduce to purely algebraic conditions in light cone coordinates  $(u, v)$  since the induced metric has only the component  $g_{uv}$ , whereas the second fundamental form has only diagonal components  $H_{uu}^k$  and  $H_{vv}^k$ .
2. For Euclidian minimal surfaces  $(u, v)$  is replaced by complex coordinates  $(w, \bar{w})$  and field equations are satisfied because the metric has only the component  $g^{w\bar{w}}$  and second fundamental form has only components of type  $H_{ww}^k$  and  $H_{\bar{w}\bar{w}}^k$ . The mechanism should generalize to the recent case.

#### The general form of energy momentum tensor as a guideline for the choice of coordinates

Any 3-dimensional Riemann manifold allows always a orthogonal coordinate system for which the metric is diagonal. Any 4-dimensional Riemann manifold in turn allows a coordinate system for which 3-metric is diagonal and the only non-diagonal components of the metric are of form  $g^{ti}$ . This kind of coordinates might be natural also now. When  $\bar{E}$  and  $\bar{B}$  are orthogonal, energy momentum tensor has the form

$$T = \begin{pmatrix} \frac{E^2+B^2}{2} & 0 & 0 & EB \\ 0 & \frac{E^2+B^2}{2} & 0 & 0 \\ 0 & 0 & \frac{-E^2+B^2}{2} & 0 \\ EB & 0 & 0 & \frac{E^2-B^2}{2} \end{pmatrix} \quad (2.3.18)$$

in the tangent space basis defined by time direction and longitudinal direction  $\overline{E} \times \overline{B}$ , and transversal directions  $\overline{E}$  and  $\overline{B}$ . Note that  $T$  is traceless.

The optimistic guess would be that the directions defined by these vectors integrate to three orthogonal coordinates of  $X^4$  and together with time coordinate define a coordinate system containing only  $g^{ti}$  as non-diagonal components of the metric. This however requires that the fields in question allow an integrating factor and, as already found, this requires  $\nabla \times X \cdot X = 0$  and this is not the case in general.

Physical intuition suggests however that  $X^4$  coordinates allow a decomposition into longitudinal and transversal degrees freedom. This would mean the existence of a time coordinate  $t$  and longitudinal coordinate  $z$  the plane defined by time coordinate and vector  $\overline{E} \times \overline{B}$  such that the coordinates  $u = t - z$  and  $v = t + z$  are light like coordinates so that the induced metric would have only the component  $g^{uv}$  whereas  $g^{vv}$  and  $g^{uu}$  would vanish in these coordinates. In the transversal space-time directions complex space-time coordinate coordinate  $w$  could be introduced. Metric could have also non-diagonal components besides the components  $g^{w\overline{w}}$  and  $g^{uv}$ .

### Hamilton Jacobi structures in $M_+^4$

Hamilton Jacobi structure in  $M_+^4$  can understood as a generalized complex structure combing transversal complex structure and longitudinal hyper-complex structure so that notion of holomorphy and Kähler structure generalize.

1. Denote by  $m^i$  the linear Minkowski coordinates of  $M^4$ . Let  $(S^+, S^-, E^1, E^2)$  denote local coordinates of  $M_+^4$  defining a *local* decomposition of the tangent space  $M^4$  of  $M_+^4$  into a direct, not necessarily orthogonal, sum  $M^4 = M^2 \oplus E^2$  of spaces  $M^2$  and  $E^2$ . This decomposition has an interpretation in terms of the longitudinal and transversal degrees of freedom defined by local light-like four-velocities  $v_\pm = \nabla S_\pm$  and polarization vectors  $\epsilon_i = \nabla E^i$  assignable to light ray. Assume that  $E^2$  allows complex coordinates  $w = E^1 + iE^2$  and  $\overline{w} = E^1 - iE^2$ . The simplest decomposition of this kind corresponds to the decomposition  $(S^+ \equiv u = t + z, S^- \equiv v = t - z, w = x + iy, \overline{w} = x - iy)$ .
2. In accordance with this physical picture,  $S^+$  and  $S^-$  define light-like curves which are normals to light-like surfaces and thus satisfy the equation:

$$(\nabla S_\pm)^2 = 0 \quad .$$

The gradients of  $S_\pm$  are obviously analogous to local light like velocity vectors  $v = (1, \overline{v})$  and  $\tilde{v} = (1, -\overline{v})$ . These equations are also obtained in geometric optics from Hamilton Jacobi equation by replacing photon's four-velocity with the gradient  $\nabla S$ : this is consistent with the interpretation of massless extremals as Bohr orbits of em field.  $S_\pm = \text{constant}$  surfaces can be interpreted as expanding light fronts. The interpretation of  $S_\pm$  as Hamilton Jacobi functions justifies the term Hamilton Jacobi structure.

The simplest surfaces of this kind correspond to  $t = z$  and  $t = -z$  light fronts which are planes. They are dual to each other by hyper complex conjugation  $u = t - z \rightarrow v = t + z$ . One should somehow generalize this conjugation operation. The simplest candidate for the conjugation  $S^+ \rightarrow S^-$  is as a conjugation induced by the conjugation for the arguments:  $S^+(t - z, t + z, x, y) \rightarrow S^-(t - z, t + z, x, y) = S^+(t + z, t - z, x, -y)$  so that a dual pair is mapped to a dual pair. In transversal degrees of freedom complex conjugation would be involved.

3. The coordinates  $(S_\pm, w, \overline{w})$  define local light cone coordinates with the line element having the form

$$\begin{aligned}
ds^2 &= g_{+-}dS^+dS^- + g_{w\bar{w}}dw d\bar{w} \\
&+ g_{+w}dS^+dw + g_{+\bar{w}}dS^+d\bar{w} \\
&+ g_{-w}dS^-dw + g_{-\bar{w}}dS^-d\bar{w} .
\end{aligned} \tag{2.3.19}$$

Conformal transformations of  $M_+^4$  leave the general form of this decomposition invariant. Also the transformations which reduces to analytic transformations  $w \rightarrow f(w)$  in transversal degrees of freedom and hyper-analytic transformations  $S^+ \rightarrow f(S^+), S^- \rightarrow f(S^-)$  in longitudinal degrees of freedom preserve this structure.

4. The basic idea is that of generalized Kähler structure meaning that the notion of Kähler function generalizes so that the non-vanishing components of metric are expressible as

$$\begin{aligned}
g_{w\bar{w}} &= \partial_w \partial_{\bar{w}} K , & g_{+-} &= \partial_{S^+} \partial_{S^-} K , \\
g_{w\pm} &= \partial_w \partial_{S^\pm} K , & g_{\bar{w}\pm} &= \partial_{\bar{w}} \partial_{S^\pm} K .
\end{aligned} \tag{2.3.20}$$

for the components of the metric. The expression in terms of Kähler function is coordinate invariant for the same reason as in case of ordinary Kähler metric. In the standard lightcone coordinates the Kähler function is given by

$$K = w_0 \bar{w}_0 + uv , \quad w_0 = x + iy , \quad u = t - z , \quad v = t + z . \tag{2.3.21}$$

The Christoffel symbols satisfy the conditions

$$\left\{ \begin{smallmatrix} k \\ w \bar{w} \end{smallmatrix} \right\} = 0 , \quad \left\{ \begin{smallmatrix} k \\ +- \end{smallmatrix} \right\} = 0 . \tag{2.3.22}$$

If energy momentum tensor has only the components  $T^{w\bar{w}}$  and  $T^{+-}$ , field equations are satisfied in  $M_+^4$  degrees of freedom.

5. The Hamilton Jacobi structures related by these transformations can be regarded as being equivalent. Since light-like 3- surface is, as the dynamical evolution defined by the light front, fixed by the 2-surface serving as the light source, these structures should be in one-one correspondence with 2-dimensional surfaces with two surfaces regarded as equivalent if they correspond to different time=constant snapshots of the same light front, or are related by a conformal transformation of  $M_+^4$ . Obviously there should be quite large number of them. Note that the generating two-dimensional surfaces relate also naturally to quaternion conformal invariance and corresponding Kac Moody invariance for which deformations defined by the  $M^4$  coordinates as functions of the light-cone coordinates of the light front evolution define Kac Moody algebra, which thus seems to appear naturally also at the level of solutions of field equations.

The task is to find all possible local light cone coordinates defining one-parameter families 2-surfaces defined by the condition  $S_i = \text{constant}$ ,  $i = + \text{ or } -$ , dual to each other and expanding with light velocity. The basic open questions are whether the generalized Kähler function indeed makes sense and whether the physical intuition about 2-surfaces as light sources parameterizing the set of all possible Hamilton Jacobi structures makes sense.

Hamilton Jacobi structure means the existence of foliations of the  $M^4$  projection of  $X^4$  by 2-D surfaces analogous to string world sheets labeled by  $w$  and the dual of this foliation defined by partonic 2-surfaces labeled by the values of  $S_i$ . Also the foliation by light-like 3-surfaces  $Y_l^3$  labeled by  $S_\pm$  with  $S_\mp$  serving as light-like coordinate for  $Y_l^3$  is implied. This is what number theoretic compactification and  $M^8 - H$  duality predict when space-time surface corresponds to hyper-quaternionic surface of  $M^8$  [?, K72] .

### Contact structure and generalized Kähler structure of $CP_2$ projection

In the case of 3-dimensional  $CP_2$  projection it is assumed that one can introduce complex coordinates  $(\xi, \bar{\xi})$  and the third coordinate  $s$ . These coordinates would correspond to a contact structure in 3-dimensional  $CP_2$  projection defining transversal symplectic and Kähler structures. In these coordinates the transversal parts of the induced  $CP_2$  Kähler form and metric would contain only components of type  $g_{w\bar{w}}$  and  $J_{w\bar{w}}$ . The transversal Kähler field  $J_{w\bar{w}}$  would induce the Kähler magnetic field and the components  $J_{s\bar{w}}$  and  $J_{s\bar{s}}$  the Kähler electric field.

It must be emphasized that the non-integrability of the contact structure implies that  $J$  cannot be parallel to the tangent planes of  $s = \text{constant}$  surfaces,  $s$  cannot be parallel to neither  $A$  nor the dual of  $J$ , and  $\xi$  cannot vary in the tangent plane defined by  $J$ . A further important conclusion is that for the solutions with 3-dimensional  $CP_2$  projection topologized Kähler charge density is necessarily non-vanishing by  $A \wedge J \neq 0$  whereas for the solutions with  $D_{CP_2} = 2$  topologized Kähler current vanishes.

Also the  $CP_2$  projection is assumed to possess a generalized Kähler structure in the sense that all components of the metric except  $s_{ss}$  are derivable from a Kähler function by formulas similar to  $M_+^4$  case.

$$s_{w\bar{w}} = \partial_w \partial_{\bar{w}} K \quad , \quad s_{ws} = \partial_w \partial_s K \quad , \quad s_{\bar{w}s} = \partial_{\bar{w}} \partial_s K \quad . \quad (2.3.23)$$

Generalized Kähler property guarantees that the vanishing of the Christoffel symbols of  $CP_2$  (rather than those of 3-dimensional projection), which are of type  $\left\{ \begin{smallmatrix} k \\ \xi \bar{\xi} \end{smallmatrix} \right\}$ .

$$\left\{ \begin{smallmatrix} k \\ \xi \bar{\xi} \end{smallmatrix} \right\} = 0 \quad . \quad (2.3.24)$$

Here the coordinates of  $CP_2$  have been chosen in such a manner that three of them correspond to the coordinates of the projection and fourth coordinate is constant at the projection. The upper index  $k$  refers also to the  $CP_2$  coordinate, which is constant for the  $CP_2$  projection. If energy momentum tensor has only components of type  $T^{+-}$  and  $T^{w\bar{w}}$ , field equations are satisfied even when if non-diagonal Christoffel symbols of  $CP_2$  are present. The challenge is to discover solution ansatz, which guarantees this property of the energy momentum tensor.

A stronger variant of Kähler property would be that also  $s_{ss}$  vanishes so that the coordinate lines defined by  $s$  would define light like curves in  $CP_2$ . The topologization of the Kähler current however implies that  $CP_2$  projection is a projection of a 3-surface with strong Kähler property. Using  $(s, \xi, \bar{\xi}, S^-)$  as coordinates for the space-time surface defined by the ansatz  $(w = w(\xi, s), S^+ = S^+(s))$  one finds that  $g_{ss}$  must be vanishing so that stronger variant of the Kähler property holds true for  $S^- = \text{constant}$  3-surfaces.

The topologization condition for the Kähler current can be solved completely generally in terms of the induced metric using  $(\xi, \bar{\xi}, s)$  and some coordinate of  $M_+^4$ , call it  $x^4$ , as space-time coordinates. Topologization boils down to the conditions

$$\begin{aligned} \partial_\beta (J^{\alpha\beta} \sqrt{g}) &= 0 \quad \text{for } \alpha \in \{\xi, \bar{\xi}, s\} \quad , \\ g^{4i} &\neq 0 \quad . \end{aligned} \quad (2.3.25)$$

Thus 3-dimensional empty space Maxwell equations and the non-orthogonality of  $X^4$  coordinate lines and the 3-surfaces defined by the lift of the  $CP_2$  projection.

### A solution ansatz yielding light-like current in $D_{CP_2} = 3$ case

The basic idea is that of generalized Kähler structure and solutions of field equations as maps or deformations of canonically imbedded  $M_+^4$  respecting this structure and guaranteeing that the only non-vanishing components of the energy momentum tensor are  $T^{\xi\xi}$  and  $T^{s-}$  in the coordinates  $(\xi, \bar{\xi}, s, S^-)$ .

1. The coordinates  $(w, S^+)$  are assumed to holomorphic functions of the  $CP_2$  coordinates  $(s, \xi)$

$$S^+ = S^+(s) \ , \quad w = w(\xi, s) \ . \quad (2.3.26)$$

Obviously  $S^+$  could be replaced with  $S^-$ . The ansatz is completely symmetric with respect to the exchange of the roles of  $(s, w)$  and  $(S^+, \xi)$  since it maps longitudinal degrees of freedom to longitudinal ones and transverse degrees of freedom to transverse ones.

2. Field equations are satisfied if the only non-vanishing components of the energy momentum tensor are of type  $T^{\xi\bar{\xi}}$  and  $T^{s-}$ . The reason is that the  $CP_2$  Christoffel symbols for projection and projections of  $M_+^4$  Christoffel symbols are vanishing for these lower index pairs.
3. By a straightforward calculation one can verify that the only manner to achieve the required structure of energy momentum tensor is to assume that the induced metric in the coordinates  $(\xi, \bar{\xi}, s, S^-)$  has as non-vanishing components only  $g_{\xi\bar{\xi}}$  and  $g_{s-}$

$$g_{ss} = 0 \ , \quad g_{\xi s} = 0 \ , \quad g_{\bar{\xi} s} = 0 \ . \quad (2.3.27)$$

Obviously the space-time surface must factorize into an orthogonal product of longitudinal and transversal spaces.

4. The condition guaranteing the product structure of the metric is

$$\begin{aligned} s_{ss} &= m_{+w} \partial_s w(\xi, s) \partial_s S^+(s) + m_{+\bar{w}} \partial_s \bar{w}(\xi, s) \partial_s S^+(s) \ , \\ s_{s\xi} &= m_{+w} \partial_\xi w(\xi) \partial_s S^+(s) \ , \\ s_{s\bar{\xi}} &= m_{+w} \partial_{\bar{\xi}} w(\bar{\xi}) \partial_s S^+(s) \ . \end{aligned} \quad (2.3.28)$$

Thus the function of dynamics is to diagonalize the metric and provide it with strong Kähler property. Obviously the  $CP_2$  projection corresponds to a light-like surface for all values of  $S^-$  so that space-time surface is foliated by light-like surfaces and the notion of generalized conformal invariance makes sense for the entire space-time surface rather than only for its boundary or elementary particle horizons.

5. The requirement that the Kähler current is proportional to the instanton current means that only the  $j^-$  component of the current is non-vanishing. This gives the following conditions

$$\begin{aligned} j^\xi \sqrt{g} &= \partial_\beta (J^{\xi\beta} \sqrt{g}) = 0 \ , \quad j^{\bar{\xi}} \sqrt{g} = \partial_\beta (J^{\bar{\xi}\beta} \sqrt{g}) = 0 \ , \\ j^+ \sqrt{g} &= \partial_\beta (J^{+\beta} \sqrt{g}) = 0 \ . \end{aligned} \quad (2.3.29)$$

Since  $J^{+\beta}$  vanishes, the condition

$$\sqrt{g} j^+ = \partial_\beta (J^{+\beta} \sqrt{g}) = 0 \quad (2.3.30)$$

is identically satisfied. Therefore the number of field equations reduces to three.

The physical interpretation of the solution ansatz deserves some comments.

1. The light-like character of the Kähler current brings in mind  $CP_2$  extremals for which  $CP_2$  projection is light like. This suggests that the topological condensation of  $CP_2$  type extremal occurs on  $D_{CP_2} = 3$  helical space-time sheet representing zitterbewegung. In the case of many-body system light-likeness of the current does not require that particles are massless if particles of opposite charges can be present. Field tensor has the form  $(J^{\xi\bar{\xi}}, J^{\xi-}, J^{\bar{\xi}-})$ . Both helical magnetic field and electric field present as is clear when one replaces the coordinates  $(S^+, S^-)$  with time-like and space-like coordinate. Magnetic field dominates but the presence of electric field means that genuine Beltrami field is not in question.
2. Since the induced metric is product metric, 3-surface is metrically product of 2-dimensional surface  $X^2$  and line or circle and obeys product topology. If absolute minima correspond to asymptotic self-organization patterns, the appearance of the product topology and even metric is not so surprising. Thus the solutions can be classified by the genus of  $X^2$ . An interesting question is how closely the explanation of family replication phenomenon in terms of the topology of the boundary component of elementary particle like 3-surface relates to this. The heaviness and instability of particles which correspond to genera  $g > 2$  (sphere with more than two handles) might have simple explanation as absence of (stable)  $D_{CP_2} = 3$  solutions of field equations with genus  $g > 2$ .
3. The solution ansatz need not be the most general. Kähler current is light-like and already this is enough to reduce the field equations to the form involving only energy momentum tensor. One might hope of finding also solution ansätze for which Kähler current is time-like or space-like. Space-likeness of the Kähler current might be achieved if the complex coordinates  $(\xi, \bar{\xi})$  and hyper-complex coordinates  $(S^+, S^-)$  change the role. For this solution ansatz electric field would dominate. Note that the possibility that Kähler current is always light-like cannot be excluded.
4. Suppose that  $CP_2$  projection quite generally defines a foliation of the space-time surface by light-like 3-surfaces, as is suggested by the conformal invariance. If the induced metric has Minkowskian signature, the fourth coordinate  $x^4$  and thus also Kähler current must be time-like or light-like so that magnetic field dominates. Already the requirement that the metric is non-degenerate implies  $g_{s4} \neq 0$  so that the metric for the  $\xi = \text{constant}$  2-surfaces has a Minkowskian signature. Thus space-like Kähler current does not allow the lift of the  $CP_2$  projection to be light-like.

### Are solutions with time-like or space-like Kähler current possible in $D_{CP_2} = 3$ case?

As noticed in the section about number theoretical compactification, the flow of gauge currents along slices  $Y_l^3$  of  $X^4(X_l^3)$  "parallel" to  $X_l^3$  requires only that gauge currents are parallel to  $Y_l^3$  and can thus space-like. The following ansatz gives good hopes for obtaining solutions with space-like and perhaps also time-like Kähler currents.

1. Assign to light-like coordinates coordinates  $(T, Z)$  by the formula  $T = S^+ + S^-$  and  $Z = S^+ - S^-$ . Space-time coordinates are taken to be  $(\xi, \bar{\xi}, s)$  and coordinate  $Z$ . The solution ansatz with time-like Kähler current results when the roles of  $T$  and  $Z$  are changed. It will however found that same solution ansatz can give rise to both space-like and time-like Kähler current.
2. The solution ansatz giving rise to a space-like Kähler current is defined by the equations

$$T = T(Z, s) \quad , \quad w = w(\xi, s) \quad . \quad (2.3.31)$$

If  $T$  depends strongly on  $Z$ , the  $g_{ZZ}$  component of the induced metric becomes positive and Kähler current time-like.

3. The components of the induced metric are

$$\begin{aligned}
g_{ZZ} &= m_{ZZ} + m_{TT} \partial_Z T \partial_s T , & g_{Zs} &= m_{TT} \partial_Z T \partial_s T , \\
g_{ss} &= s_{ss} + m_{TT} \partial_s T \partial_s T , & g_{w\bar{w}} &= s_{w\bar{w}} + m_{w\bar{w}} \partial_\xi w \partial_{\bar{\xi}} \bar{w} , \\
g_{s\xi} &= s_{s\xi} , & g_{s\bar{\xi}} &= s_{s\bar{\xi}} .
\end{aligned} \tag{2.3.32}$$

Topologized Kähler current has only  $Z$ -component and 3-dimensional empty space Maxwell's equations guarantee the topologization.

In  $CP_2$  degrees of freedom the contractions of the energy momentum tensor with Christoffel symbols vanish if  $T^{ss}$ ,  $T^{\xi s}$  and  $T^{\xi\xi}$  vanish as required by internal consistency. This is guaranteed if the condition

$$J^{\xi s} = 0 \tag{2.3.33}$$

holds true. Note however that  $J^{\xi Z}$  is non-vanishing. Therefore only the components  $T^{\xi\bar{\xi}}$  and  $T^{Z\xi}$ ,  $T^{Z\bar{\xi}}$  of energy momentum tensor are non-vanishing, and field equations reduce to the conditions

$$\begin{aligned}
\partial_{\bar{\xi}}(J^{\xi\bar{\xi}}\sqrt{g}) + \partial_Z(J^{\xi Z}\sqrt{g}) &= 0 , \\
\partial_\xi(J^{\xi\bar{\xi}}\sqrt{g}) + \partial_Z(J^{\xi Z}\sqrt{g}) &= 0 .
\end{aligned} \tag{2.3.34}$$

In the special case that the induced metric does not depend on  $z$ -coordinate equations reduce to holomorphicity conditions. This is achieved if  $T$  depends linearly on  $Z$ :  $T = aZ$ .

The contractions with  $M_+^4$  Christoffel symbols come from the non-vanishing of  $T^{Z\xi}$  and vanish if the Hamilton Jacobi structure satisfies the conditions

$$\begin{aligned}
\{T^k_w\} = 0 , \quad \{T^k_{\bar{w}}\} = 0 , \\
\{Z^k_w\} = 0 , \quad \{Z^k_{\bar{w}}\} = 0
\end{aligned} \tag{2.3.35}$$

hold true. The conditions are equivalent with the conditions

$$\{\pm^k_w\} = 0 , \quad \{\pm^k_{\bar{w}}\} = 0 . \tag{2.3.36}$$

These conditions possess solutions (standard light cone coordinates are the simplest example). Also the second derivatives of  $T(s, Z)$  contribute to the second fundamental form but they do not give rise to non-vanishing contractions with the energy momentum tensor. The cautious conclusion is that also solutions with time-like or space-like Kähler current are possible.

#### $DCP_2 = 4$ case

The preceding discussion was for  $DCP_2 = 3$  and one should generalize the discussion to  $DCP_2 = 4$  case.

1. Hamilton Jacobi structure for  $M_+^4$  is expected to be crucial also now.
2. One might hope that for  $DCP_2 = 4$  the Kähler structure of  $CP_2$  defines a foliation of  $CP_2$  by 3-dimensional contact structures. This requires that there is a coordinate varying along the field lines of the normal vector field  $X$  defined as the dual of the three-form  $A \wedge dA = A \wedge J$ . By the previous considerations the condition for this reads as  $dX = d(\log\phi) \wedge X$  and implies  $X \wedge dX = 0$ . Using the self duality of the Kähler form one can express  $X$  as  $X^k = J^{kl}A_l$ . By a brief calculation one finds that  $X \wedge dX \propto X$  holds true so that (somewhat disappointingly) a foliation of  $CP_2$  by contact structures does not exist.

For  $D_{CP_2} = 4$  case Kähler current vanishes and this case corresponds to what I have called earlier Maxwellian phase since empty space Maxwell's equations are indeed satisfied.

1. *Solution ansatz with a 3-dimensional  $M_+^4$  projection*

The basic idea is that the complex structure of  $CP_2$  is preserved so that one can use complex coordinates  $(\xi^1, \xi^2)$  for  $CP_2$  in which  $CP_2$  Christoffel symbols and energy momentum tensor have automatically the desired properties. This is achieved the second light like coordinate, say  $v$ , is non-dynamical so that the induced metric does not receive any contribution from the longitudinal degrees of freedom. In this case one has

$$S^+ = S^+(\xi^1, \xi^2) , \quad w = w(\xi^1, \xi^2) , \quad S^- = \text{constant} . \quad (2.3.37)$$

The induced metric does possess only components of type  $g_{i\bar{j}}$  if the conditions

$$g_{+w} = 0 , \quad g_{+\bar{w}} = 0 . \quad (2.3.38)$$

This guarantees that energy momentum tensor has only components of type  $T^{i\bar{j}}$  in coordinates  $(\xi^1, \xi^2)$  and their contractions with the Christoffel symbols of  $CP_2$  vanish identically. In  $M_+^4$  degrees of freedom one must pose the conditions

$$\{^k_{w+}\} = 0 , \quad \{^k_{\bar{w}+}\} = 0 , \quad \{^k_{++}\} = 0 . \quad (2.3.39)$$

on Christoffel symbols. These conditions are satisfied if the the  $M_+^4$  metric does not depend on  $S^+$ :

$$\partial_+ m_{kl} = 0 . \quad (2.3.40)$$

This means that  $m_{-w}$  and  $m_{-\bar{w}}$  can be non-vanishing but like  $m_{+-}$  they cannot depend on  $S^+$ .

The second derivatives of  $S^+$  appearing in the second fundamental form are also a source of trouble unless they vanish. Hence  $S^+$  must be a linear function of the coordinates  $\xi^k$ :

$$S^+ = a_k \xi^k + \bar{a}_k \bar{\xi}^k . \quad (2.3.41)$$

Field equations are the counterparts of empty space Maxwell equations  $j^\alpha = 0$  but with  $M_+^4$  coordinates  $(u, w)$  appearing as dynamical variables and entering only through the induced metric. By holomorphy the field equations can be written as

$$\partial_j (J^{j\bar{i}} \sqrt{g}) = 0 , \quad \partial_{\bar{j}} (J^{\bar{j}i} \sqrt{g}) = 0 , \quad (2.3.42)$$

and can be interpreted as conditions stating the holomorphy of the contravariant Kähler form.

What is remarkable is that the  $M_+^4$  projection of the solution is 3-dimensional light like surface and that the induced metric has Euclidian signature. Light front would become a concrete geometric object with one compactified dimension rather than being a mere conceptualization. One could see this as topological quantization for the notion of light front or of electromagnetic shock wave, or perhaps even as the realization of the particle aspect of gauge fields at classical level.

If the latter interpretation is correct, quantum classical correspondence would be realized very concretely. Wave and particle aspects would both be present. One could understand the interactions of charged particles with electromagnetic fields both in terms of absorption and emission of topological field quanta and in terms of the interaction with a classical field as particle topologically condenses at the photonic light front.

For  $CP_2$  type extremals for which  $M_+^4$  projection is a light like curve correspond to a special case of this solution ansatz: transversal  $M_+^4$  coordinates are constant and  $S^+$  is now arbitrary function of  $CP_2$  coordinates. This is possible since  $M_+^4$  projection is 1-dimensional.

2. *Are solutions with a 4-dimensional  $M_+^4$  projection possible?*



The most natural solution ansatz is the one for which  $CP_2$  complex structure is preserved so that energy momentum tensor has desired properties. For four-dimensional  $M_+^4$  projection this ansatz does not seem to make promising since the contribution of the longitudinal degrees of freedom implies that the induced metric is not anymore of desired form since the components  $g_{ij} = m_{+-}(\partial_{\xi^i} S^+ \partial_{\xi^j} S^- + m_{+-} \partial_{\xi^i} S^- \partial_{\xi^j} S^+)$  are non-vanishing.

1. The natural dynamical variables are still Minkowski coordinates  $(w, \bar{w}, S^+, S^-)$  for some Hamilton Jacobi structure. Since the complex structure of  $CP_2$  must be given up,  $CP_2$  coordinates can be written as  $(\xi, s, r)$  to stress the fact that only "one half" of the Kähler structure of  $CP_2$  is respected by the solution ansatz.
2. The solution ansatz has the same general form as in  $D_{CP_2} = 3$  case and must be symmetric with respect to the exchange of  $M_+^4$  and  $CP_2$  coordinates. Transverse coordinates are mapped to transverse ones and longitudinal coordinates to longitudinal ones:

$$(S^+, S^-) = (S^+(s, r), S^-(s, r)) \quad , \quad w = w(\xi) \quad . \quad (2.3.43)$$

This ansatz would describe ordinary Maxwell field in  $M_+^4$  since the roles of  $M_+^4$  coordinates and  $CP_2$  coordinates are interchangeable.

It is however far from obvious whether there are any solutions with a 4-dimensional  $M_+^4$  projection. That empty space Maxwell's equations would allow only the topologically quantized light fronts as its solutions would realize quantum classical correspondence very concretely.

#### $D_{CP_2} = 2$ case

Hamilton Jacobi structure for  $M_+^4$  is assumed also for  $D_{CP_2} = 2$ , whereas the contact structure for  $CP_2$  is in  $D_{CP_2} = 2$  case replaced by the induced Kähler structure. Topologization yields vanishing Kähler current. Light-likeness provides a second manner to achieve vanishing Lorentz force but one cannot exclude the possibility of time- and space-like Kähler current.

##### 1. Solutions with vanishing Kähler current

1. String like objects, which are products  $X^2 \times Y^2 \subset M_+^4 \times CP_2$  of minimal surfaces  $Y^2$  of  $M_+^4$  with geodesic spheres  $S^2$  of  $CP_2$  and carry vanishing gauge current. String like objects allow considerable generalization from simple Cartesian products of  $X^2 \times Y^2 \subset M_+^4 \times S^2$ . Let  $(w, \bar{w}, S^+, S^-)$  define the Hamilton Jacobi structure for  $M_+^4$ .  $w = \text{constant}$  surfaces define minimal surfaces  $X^2$  of  $M_+^4$ . Let  $\xi$  denote complex coordinate for a sub-manifold of  $CP_2$  such that the imbedding to  $CP_2$  is holomorphic:  $(\xi^1, \xi^2) = (f^1(\xi), f^2(\xi))$ . The resulting surface  $Y^2 \subset CP_2$  is a minimal surface and field equations reduce to the requirement that the Kähler current vanishes:  $\partial_{\bar{\xi}}(J^{\xi\bar{\xi}} \sqrt{g_2}) = 0$ . One-dimensional strings are deformed to 3-dimensional cylinders representing magnetic flux tubes. The oscillations of string correspond to waves moving along string with light velocity, and for more general solutions they become TGD counterparts of Alfven waves associated with magnetic flux tubes regarded as oscillations of magnetic flux lines behaving effectively like strings. It must be emphasized that Alfven waves are a phenomenological notion not really justified by the properties of Maxwell's equations.
2. Also electret type solutions with the role of the magnetic field taken by the electric field are possible.  $(\xi, \bar{\xi}, u, v)$  would provide the natural coordinates and the solution ansatz would be of the form

$$(s, r) = (s(u, v), r(u, v)) \quad , \quad \xi = \text{constant} \quad , \quad (2.3.44)$$

and corresponds to a vanishing Kähler current.

3. Both magnetic and electric fields are necessarily present only for the solutions carrying non-vanishing electric charge density (proportional to  $\bar{B} \cdot \bar{A}$ ). Thus one can ask whether more general solutions carrying both magnetic and electric field are possible. As a matter fact, one must first answer the question what one really means with the magnetic field. By choosing the coordinates of 2-dimensional  $CP_2$  projection as space-time coordinates one can define what one means with magnetic and electric field in a coordinate invariant manner. Since the  $CP_2$  Kähler form for the  $CP_2$  projection with  $D_{CP_2} = 2$  can be regarded as a pure Kähler magnetic field, the induced Kähler field is either magnetic field or electric field.

The form of the ansatz would be

$$(s, r) = (s, r)(u, v, w, \bar{w}) \ , \ \xi = \text{constant} \ . \quad (2.3.45)$$

As a matter fact,  $CP_2$  coordinates depend on two properly chosen  $M^4$  coordinates only.

### 1. Solutions with light-like Kähler current

There are large classes of solutions of field equations with a light-like Kähler current and 2-dimensional  $CP_2$  projection.

1. Massless extremals for which  $CP_2$  coordinates are arbitrary functions of one transversal coordinate  $e = f(w, \bar{w})$  defining local polarization direction and light like coordinate  $u$  of  $M^4_{\pm}$  and carrying in the general case a light like current. In this case the holomorphy does not play any role.
2. The string like solutions thickened to magnetic flux tubes carrying TGD counterparts of Alfven waves generalize to solutions allowing also light-like Kähler current. Also now Kähler metric is allowed to develop a component between longitudinal and transversal degrees of freedom so that Kähler current develops a light-like component. The ansatz is of the form

$$\xi^i = f^i(\xi) \ , \ w = w(\xi) \ , \ S^- = s^- \ , \ S^+ = s^+ + f(\xi, \bar{\xi}) \ .$$

Only the components  $g_{+\xi}$  and  $g_{+\bar{\xi}}$  of the induced metric receive contributions from the modification of the solution ansatz. The contravariant metric receives contributions to  $g^{-\xi}$  and  $g^{-\bar{\xi}}$  whereas  $g^{+\xi}$  and  $g^{+\bar{\xi}}$  remain zero. Since the partial derivatives  $\partial_{\xi}\partial_+h^k$  and  $\partial_{\bar{\xi}}\partial_+h^k$  and corresponding projections of Christoffel symbols vanish, field equations are satisfied. Kähler current develops a non-vanishing component  $j^-$ . Apart from the presence of the electric field, these solutions are highly analogous to Beltrami fields.

### Could $D_{CP_2} = 2 \rightarrow 3$ transition occur in rotating magnetic systems?

I have studied the imbeddings of simple cylindrical and helical magnetic fields in various applications of TGD to condensed matter systems, in particular in attempts to understand the strange findings about rotating magnetic systems [K76] .

Let  $S^2$  be the homologically non-trivial geodesic sphere of  $CP_2$  with standard spherical coordinates  $(U \equiv \cos(\theta), \Phi)$  and let  $(t, \rho, \phi, z)$  denote cylindrical coordinates for a cylindrical space-time sheet. The simplest possible space-time surfaces  $X^4 \subset M^4_{\pm} \times S^2$  carrying helical Kähler magnetic field depending on the radial cylindrical coordinate  $\rho$ , are given by:

$$\begin{aligned} U &= U(\rho) \ , \quad \Phi = n\phi + kz \ , \\ J_{\rho\phi} &= n\partial_{\rho}U \ , \quad J_{\rho z} = k\partial_{\rho}U \ . \end{aligned} \quad (2.3.46)$$

This helical field is not Beltrami field as one can easily find. A more general ansatz corresponding defined by

$$\Phi = \omega t + kz + n\phi$$

would in cylindrical coordinates give rise to both helical magnetic field and radial electric field depending on  $\rho$  only. This field can be obtained by simply replacing the vector potential with its rotated

version and provides the natural first approximation for the fields associated with rotating magnetic systems.

A non-vanishing vacuum charge density is however generated when a constant magnetic field is put into rotation and is implied by the condition  $\vec{E} = \vec{v} \times \vec{B}$  stating vanishing of the Lorentz force. This condition does not follow from the induction law of Faraday although Faraday observed this effect first. This is also clear from the fact that the sign of the charge density depends on the direction of rotation.

The non-vanishing charge density is not consistent with the vanishing of the Kähler 4-current and requires a 3-dimensional  $CP_2$  projection and topologization of the Kähler current. Beltrami condition cannot hold true exactly for the rotating system. The conclusion is that rotation induces a phase transition  $D_{CP_2} = 2 \rightarrow 3$ . This could help to understand various strange effects related to the rotating magnetic systems [K76]. For instance, the increase of the dimension of  $CP_2$  projection could generate join along boundaries contacts and wormhole contacts leading to the transfer of charge between different space-time sheets. The possibly resulting flow of gravitational flux to larger space-time sheets might help to explain the claimed antigravity effects.

### 2.3.4 $D_{CP_2} = 3$ phase allows infinite number of topological charges characterizing the linking of magnetic field lines

When space-time sheet possesses a  $D = 3$ -dimensional  $CP_2$  projection, one can assign to it a non-vanishing and conserved topological charge characterizing the linking of the magnetic field lines defined by Chern-Simons action density  $A \wedge dA/4\pi$  for induced Kähler form. This charge can be seen as classical topological invariant of the linked structure formed by magnetic field lines.

The topological charge can also vanish for  $D_{CP_2} = 3$  space-time sheets. In Darboux coordinates for which Kähler gauge potential reads as  $A = P_k dQ^k$ , the surfaces of this kind result if one has  $Q^2 = f(Q^1)$  implying  $A = fdQ^1$ ,  $f = P_1 + P_2 \partial_{Q_1} Q^2$ , which implies the condition  $A \wedge dA = 0$ . For these space-time sheets one can introduce  $Q^1$  as a global coordinate along field lines of  $A$  and define the phase factor  $\exp(i \int A_\mu dx^\mu)$  as a wave function defined for the entire space-time sheet. This function could be interpreted as a phase of an order parameter of super-conductor like state and there is a high temptation to assume that quantum coherence in this sense is lost for more general  $D_{CP_2} = 3$  solutions.

Chern-Simons action is known as helicity in electrodynamics [?]. Helicity indeed describes the linking of magnetic flux lines as is easy to see by interpreting magnetic field as incompressible fluid flow having  $A$  as vector potential:  $B = \nabla \times A$ . One can write  $A$  using the inverse of  $\nabla \times$  as  $A = (1/\nabla \times)B$ . The inverse is non-local operator expressible as

$$\frac{1}{\nabla \times} B(r) = \int dV' \frac{(r - r')}{|r - r'|^3} \times B(r') ,$$

as a little calculation shows. This allows to write  $\int A \cdot B$  as

$$\int dV A \cdot B = \int dV dV' B(r) \cdot \left( \frac{(r - r')}{|r - r'|^3} \times B(r') \right) ,$$

which is completely analogous to the Gauss formula for linking number when linked curves are replaced by a distribution of linked curves and an average is taken.

For  $D_{CP_2} = 3$  field equations imply that Kähler current is proportional to the helicity current by a factor which depends on  $CP_2$  coordinates, which implies that the current is automatically divergence free and defines a conserved charge for  $D = 3$ -dimensional  $CP_2$  projection for which the instanton density vanishes identically. Kähler charge is not equal to the helicity defined by the inner product of magnetic field and vector potential but to a more general topological charge.

The number of conserved topological charges is infinite since the product of any function of  $CP_2$  coordinates with the helicity current has vanishing divergence and defines a topological charge. A very natural function basis is provided by the scalar spherical harmonics of  $SU(3)$  defining Hamiltonians of  $CP_2$  canonical transformations and possessing well defined color quantum numbers. These functions define an infinite number of conserved charges which are also classical knot invariants in the sense that they are not affected at all when the 3-surface interpreted as a map from  $CP_2$  projection to  $M_+^4$  is deformed in  $M_+^4$  degrees of freedom. Also canonical transformations induced by Hamiltonians in

irreducible representations of color group affect these invariants via Poisson bracket action when the  $U(1)$  gauge transformation induced by the canonical transformation corresponds to a single valued scalar function. These link invariants are additive in union whereas the quantum invariants defined by topological quantum field theories are multiplicative.

Also non-Abelian topological charges are well-defined. One can generalize the topological current associated with the Kähler form to a corresponding current associated with the induced electro-weak gauge fields whereas for classical color gauge fields the Chern-Simons form vanishes identically. Also in this case one can multiply the current by  $CP_2$  color harmonics to obtain an infinite number of invariants in  $D_{CP_2} = 3$  case. The only difference is that  $A \wedge dA$  is replaced by  $Tr(A \wedge (dA + 2A \wedge A/3))$ .

There is a strong temptation to assume that these conserved charges characterize colored quantum states of the conformally invariant quantum theory as a functional of the light-like 3-surface defining boundary of space-time sheet or elementary particle horizon surrounding wormhole contacts. They would be TGD analogs of the states of the topological quantum field theory defined by Chern-Simons action as highest weight states associated with corresponding Wess-Zumino-Witten theory. These charges could be interpreted as topological counterparts of the isometry charges of configuration space of 3-surfaces defined by the algebra of canonical transformations of  $CP_2$ .

The interpretation of these charges as contributions of light-like boundaries to configuration space Hamiltonians would be natural. The dynamics of the induced second quantized spinor fields relates to that of Kähler action by a super-symmetry, so that it should define super-symmetric counterparts of these knot invariants. The anti-commutators of these super charges cannot however contribute to configuration space Kähler metric so that topological zero modes are in question. These Hamiltonians and their super-charge counterparts would be responsible for the topological sector of quantum TGD.

### 2.3.5 Preferred extremal property and the topologization/light-likeness of Kähler current?

The basic question is under what conditions the Kähler current is either topologized or light-like so that the Lorentz force vanishes. Does this hold for all preferred extremals of Kähler action? Or only asymptotically as suggested by the fact that generalized Beltrami fields can be interpreted as asymptotic self-organization patterns, when dissipation has become insignificant. Or does topologization take place in regions of space-time surface having Minkowskian signature of the induced metric? And what asymptotia actually means? Do absolute minima of Kähler action correspond to preferred extremals?

One can challenge the interpretation in terms of asymptotic self organization patterns assigned to the Minkowskian regions of space-time surface.

1. Zero energy ontology challenges the notion of approach to asymptotia in Minkowskian sense since the dynamics of light-like 3-surfaces is restricted inside finite volume  $CD \subset M^4$  since the partonic 2-surfaces representing their ends are at the light-like boundaries of causal diamond in a given p-adic time scale.
2. One can argue that generic non-asymptotic field configurations have  $D_{CP_2} = 4$ , and would thus carry a vanishing Kähler four-current if Beltrami conditions were satisfied universally rather than only asymptotically.  $j^\alpha = 0$  would obviously hold true also for the asymptotic configurations, in particular those with  $D_{CP_2} < 4$  so that empty space Maxwell's field equations would be universally satisfied for asymptotic field configurations with  $D_{CP_2} < 4$ . The weak point of this argument is that it is 3-D light-like 3-surfaces rather than space-time surfaces which are the basic dynamical objects so that the generic and only possible case corresponds to  $D_{CP_2} = 3$  for  $X_1^3$ . It is quite possible that preferred extremal property implies that  $D_{CP_2} = 3$  holds true in the Minkowskian regions since these regions indeed represent empty space. Geometrically this would mean that the  $CP_2$  projection does not change as the light-like coordinate labeling  $Y_1^3$  varies. This conforms nicely with the notion of quantum gravitational holography.
3. The failure of the generalized Beltrami conditions would mean that Kähler field is completely analogous to a dissipative Maxwell field for which also Lorentz force vanishes since  $\vec{j} \cdot \vec{E}$  is non-vanishing (note that isometry currents are conserved although energy momentum tensor is not). Quantum classical correspondence states that classical space-time dynamics is by its classical non-determinism able to mimic the non-deterministic sequence of quantum jumps at

space-time level, in particular dissipation in various length scales defined by the hierarchy of space-time sheets. Classical fields would represent "symbolically" the average dynamics, in particular dissipation, in shorter length scales. For instance, vacuum 4-current would be a symbolic representation for the average of the currents consisting of elementary particles. This would seem to support the view that  $D_{CP_2} = 4$  Minkowskian regions are present. The weak point of this argument is that there is fractal hierarchy of length scales represented by the hierarchy of causal diamonds ( $CDs$ ) and that the resulting hierarchy of generalized Feynman graphs might be enough to represent dissipation classically.

4. One objection to the idea is that second law realized as an asymptotic vanishing of Lorentz-Kähler force implies that all space-like 3-surfaces approaching same asymptotic state have the same value of Kähler function assuming that the Kähler function assignable to space-like 3-surface is same for all space-like sections of  $X^4(X_l^3)$  (assuming that one can realize general coordinate invariance also in this sense). This need not be the case. In any case, this need not be a problem since it would mean an additional symmetry extending general coordinate invariance. The exponent of Kähler function would be highly analogous to a partition function defined as an exponent of Hamiltonian with Kähler coupling strength playing the role of temperature.

It seems that asymptotic self-organization pattern need not be correct interpretation for non-dissipating regions, and the identification of light-like 3-surfaces as generalized Feynman diagrams encourages an alternative interpretation.

1.  $M^8 - H$  duality states that also the  $H$  counterparts of co-hyper-hyperquaternionic surfaces of  $M^8$  are preferred extremals of Kähler action.  $CP_2$  type vacuum extremals represent the basic example of these and a plausible conjecture is that the regions of space-time with Euclidian signature of the induced metric represent this kind of regions. If this conjecture is correct, dissipation could be assigned with regions having Euclidian signature of the induced metric. This makes sense since dissipation has quantum description in terms of Feynman graphs and regions of Euclidian signature indeed correspond to generalized Feynman graphs. This argument would suggest that generalized Beltrami conditions or light-likeness hold true inside Minkowskian regions rather than only asymptotically.
2. One could of course play language games and argue that asymptotia is with respect to the Euclidian time coordinate inside generalized Feynman graphs and is achieved exactly when the signature of the induced metric becomes Minkowskian. This is somewhat artificial attempt to save the notion of asymptotic self-organization pattern since the regions outside Feynman diagrams represent empty space providing a holographic representations for the matter at  $X_l^3$  so that the vanishing of  $j^\alpha F_{\alpha\beta}$  is very natural.
3. What is then the correct identification of asymptotic self-organization pattern. Could correspond to the negative energy part of the zero energy state at the upper light-like boundary  $\delta M_-^4$  of  $CD$ ? Or in the case of phase conjugate state to the positive energy part of the state at  $\delta M_+^4$ ? An identification consistent with the fractal structure of zero energy ontology and TGD inspired theory of consciousness is that the entire zero energy state reached by a sequence of quantum jumps represents asymptotic self-organization pattern represented by the asymptotic generalized Feynman diagram or their superposition. Biological systems represent basic examples about self-organization, and one cannot avoid the questions relating to the relationship between experience and geometric time. A detailed discussion of these points can be found in [?].

Absolute minimization of Kähler action was the first guess for the criterion selecting preferred extremals. Absolute minimization in a strict sense of the word does not make sense in the p-adic context since p-adic numbers are not well-ordered, and one cannot even define the action integral as a p-adic number. The generalized Beltrami conditions and the boundary conditions defining the preferred extremals are however local and purely algebraic and make sense also p-adically. If absolute minimization reduces to these algebraic conditions, it would make sense.

### 2.3.6 Generalized Beltrami fields and biological systems

The following arguments support the view that generalized Beltrami fields play a key role in living systems, and that  $D_{CP_2} = 2$  corresponds to ordered phase,  $D_{CP_2} = 3$  to spin glass phase and  $D_{CP_2} = 4$

to chaos, with  $D_{CP_2} = 3$  defining life as a phenomenon at the boundary between order and chaos. If the criteria suggested by the number theoretic compactification are accepted, it is not clear whether  $D_{CP_2}$  extremals can define preferred extremals of Kähler action. For instance, cosmic strings are not preferred extremals and the  $Y_I^3$  associated with MEs allow only covariantly constant right handed neutrino eigenmode of  $D_K(X^2)$ . The topological condensation of  $CP_2$  type vacuum extremals around  $D_{CP_2} = 2$  type extremals is however expected to give preferred extremals and if the density of the condensate is low enough one can still speak about  $D_{CP_2} = 2$  phase. A natural guess is also that the deformation of  $D_{CP_2} = 2$  extremals transforms light-like gauge currents to space-like topological currents allowed by  $D_{CP_2} = 3$  phase.

### Why generalized Beltrami fields are important for living systems?

Chirality, complexity, and high level of organization make  $D_{CP_2} = 3$  generalized Beltrami fields excellent candidates for the magnetic bodies of living systems.

1. Chirality selection is one of the basic signatures of living systems. Beltrami field is characterized by a chirality defined by the relative sign of the current and magnetic field, which means parity breaking. Chirality reduces to the sign of the function  $\psi$  appearing in the topologization condition and makes sense also for the generalized Beltrami fields.
2. Although Beltrami fields can be extremely complex, they are also extremely organized. The reason is that the function  $\alpha$  is constant along flux lines so that flux lines must in the case of compact Riemann 3-manifold belong to 2-dimensional  $\alpha = \text{constant}$  closed surfaces, in fact two-dimensional invariant tori [?].

For generalized Beltrami fields the function  $\psi$  is constant along the flow lines of the Kähler current. Space-time sheets with 3-dimensional  $CP_2$  projection serve as an illustrative example. One can use the coordinates for the  $CP_2$  projection as space-time coordinates so that one space-time coordinate disappears totally from consideration. Hence the situation reduces to a flow in a 3-dimensional sub-manifold of  $CP_2$ . One can distinguish between three types of flow lines corresponding to space-like, light-like and time-like topological current. The 2-dimensional  $\psi = \text{constant}$  invariant manifolds are sub-manifolds of  $CP_2$ . Ordinary Beltrami fields are a special case of space-like flow with flow lines belonging to the 2-dimensional invariant tori of  $CP_2$ . Time-like and light-like situations are more complex since the flow lines need not be closed so that the 2-dimensional  $\psi = \text{constant}$  surfaces can have boundaries.

For periodic self-organization patterns flow lines are closed and  $\psi = \text{constant}$  surfaces of  $CP_2$  must be invariant tori. The dynamics of the periodic flow is obtained from that of a steady flow by replacing one spatial coordinate with effectively periodic time coordinate. Therefore topological notions like helix structure, linking, and knotting have a dynamical meaning at the level of  $CP_2$  projection. The periodic generalized Beltrami fields are highly organized also in the temporal domain despite the potentiality for extreme topological complexity.

For these reasons topologically quantized generalized Beltrami fields provide an excellent candidate for a generic model for the dynamics of biological self-organization patterns. A natural guess is that many-sheeted magnetic and  $Z^0$  magnetic fields and their generalizations serve as templates for the helical molecules populating living matter, and explain both chiral selection, the complex linking and knotting of DNA and protein molecules, and even the extremely complex and self-organized dynamics of biological systems at the molecular level.

The intricate topological structures of DNA, RNA, and protein molecules are known to have a deep significance besides their chemical structure, and they could even define something analogous to the genetic code. Usually the topology and geometry of bio-molecules is believed to reduce to chemistry. TGD suggests that space-like generalized Beltrami fields serve as templates for the formation of bio-molecules and bio-structures in general. The dynamics of bio-systems would in turn utilize the time-like Beltrami fields as templates. There could even exist a mapping from the topology of magnetic flux tube structures serving as templates for bio-molecules to the templates of self-organized dynamics. The helical structures, knotting, and linking of bio-molecules would thus define a symbolic representation, and even coding for the dynamics of the bio-system analogous to written language.

**$D_{CP_2} = 3$  systems as boundary between  $D_{CP_2} = 2$  order and  $D_{CP_2} = 4$  chaos**

The dimension of  $CP_2$  projection is basic classifier for the asymptotic self-organization patterns.

1.  $D_{CP_2} = 4$  phase, dead matter, and chaos

$D_{CP_2} = 4$  corresponds to the ordinary Maxwellian phase in which Kähler current and charge density vanish and there is no topologization of Kähler current. By its maximal dimension this phase would naturally correspond to disordered phase, ordinary "dead matter". If one assumes that Kähler charge corresponds to either em charge or  $Z^0$  charge then the signature of this state of matter would be em neutrality or  $Z^0$  neutrality.

2.  $D_{CP_2} = 2$  phase as ordered phase

By the low dimension of  $CP_2$  projection  $D_{CP_2} = 2$  phase is the least stable phase possible only at cold space-time sheets. Kähler current is either vanishing or light-like, and Beltrami fields are not possible. This phase is highly ordered and much like a topological quantized version of ferro-magnet. In particular, it is possible to have a global coordinate varying along the field lines of the vector potential also now. The magnetic and  $Z^0$  magnetic body of any system is a candidate for this kind of system.  $Z^0$  field is indeed always present for vacuum extremals having  $D_{CP_2} = 2$  and the vanishing of em field requires that that  $\sin^2(\theta_W)$  ( $\theta_W$  is Weinberg angle) vanishes.

3.  $D_{CP_2} = 3$  corresponds to living matter

$D_{CP_2} = 3$  corresponds to highly organized phase characterized in the case of space-like Kähler current by complex helical structures necessarily accompanied by topologized Kähler charge density  $\propto \bar{A} \cdot \bar{B} \neq 0$  and Kähler current  $\bar{E} \times \bar{A} + \phi \bar{B}$ . For time like Kähler currents the helical structures are replaced by periodic oscillation patterns for the state of the system. By the non-maximal dimension of  $CP_2$  projection this phase must be unstable against too strong external perturbations and cannot survive at too high temperatures. Living matter is thus excellent candidate for this phase and it might be that the interaction of the magnetic body with living matter makes possible the transition from  $D_{CP_2} = 2$  phase to the self-organizing  $D_{CP_2} = 3$  phase.

Living matter which is indeed populated by helical structures providing examples of space-like Kähler current. Strongly charged lipid layers of cell membrane might provide example of time-like Kähler current. Cell membrane, micro-tubuli, DNA, and proteins are known to be electrically charged and  $Z^0$  charge plays key role in TGD based model of catalysis discussed in [K26]. For instance, denaturing of DNA destroying its helical structure could be interpreted as a transition leading from  $D_{CP_2} = 3$  phase to  $D_{CP_2} = 4$  phase. The prediction is that the denatured phase should be electro-magnetically (or  $Z^0$ ) neutral.

Beltrami fields result when Kähler charge density vanishes. For these configurations magnetic field and current density take the role of the vector potential and magnetic field as far as the contact structure is considered. For Beltrami fields there exist a global coordinate along the field lines of the vector potential but not along those of the magnetic field. As a consequence, the covariant consistency condition  $(\partial_s - qeA_s)\Psi = 0$  frequently appearing in the physics of super conducting systems would make sense along the flow lines of the vector potential for the order parameter of Bose-Einstein condensate. If Beltrami phase is super-conducting, then the state of the system must change in the transition to a more general phase. It is impossible to assign slicing of 4-surface by 3-D surfaces labeled by a coordinate  $t$  varying along the flow lines. This means that one cannot speak about a continuous evolution of Schrödinger amplitude with  $t$  playing the role of time coordinate. One could perhaps say that the entire space-time sheet represents single quantum event which cannot be decomposed to evolution. This would conform with the assignment of macroscopic and macro-temporal quantum coherence with living matter.

The existence of these three phases brings in mind systems allowing chaotic de-magnetized phase above critical temperature  $T_c$ , spin glass phase at the critical point, and ferromagnetic phase below  $T_c$ . Similar analogy is provided by liquid phase, liquid crystal phase possible in the vicinity of the critical point for liquid to solid transition, and solid phase. Perhaps one could regard  $D_{CP_2} = 3$  phase and life as a boundary region between  $D_{CP_2} = 2$  order and  $D_{CP_2} = 4$  chaos. This would naturally explain why life as it is known is possible in relatively narrow temperature interval.

### Can one assign a continuous Schrödinger time evolution to light-like 3-surfaces?

Alain Connes wrote [?] about factors of various types using as an example Schrödinger equation for various kinds of foliations of space-time to time=constant slices. If this kind of foliation does not exist, one cannot speak about time evolution of Schrödinger equation at all. Depending on the character of the foliation one can have factor of type I, II, or III. For instance, torus with slicing  $dx = ady$  in flat coordinates, gives a factor of type I for rational values of  $a$  and factor of type II for irrational values of  $a$ .

#### 1. 3-D foliations and type III factors

Connes mentioned 3-D foliations  $V$  which give rise to type III factors. Foliation property requires a slicing of  $V$  by a one-form  $v$  to which slices are orthogonal (this requires metric).

1. The foliation property requires that  $v$  multiplied by suitable scalar is gradient. This gives the integrability conditions  $dv = w \wedge v$ ,  $w = -d\psi/\psi = -d\log(\psi)$ . Something proportional to  $\log(\psi)$  can be taken as a third coordinate varying along flow lines of  $v$ : the flow defines a continuous sequence of maps of 2-dimensional slice to itself.
2. If the so called Godbillon-Vey invariant defined as the integral of  $dw \wedge w$  over  $V$  is non-vanishing, factor of type III is obtained using Schrödinger amplitudes for which the flow lines of foliation define the time evolution. The operators of the algebra in question are transversal operators acting on Schrödinger amplitudes at each slice. Essentially Schrödinger equation in 3-D space-time would be in question with factor of type III resulting from the exotic choice of the time coordinate defining the slicing.

#### 2. What happens in case of light-like 3-surfaces?

In TGD light-like 3-surfaces are natural candidates for  $V$  and it is interesting to look what happens in this case. Light-likeness is of course a disturbing complication since orthogonality condition and thus contravariant metric is involved with the definition of the slicing. Light-likeness is not however involved with the basic conditions.

1. The one-form  $v$  defined by the induced Kähler gauge potential  $A$  defining also a braiding is a unique identification for  $v$ . If foliation exists, the braiding flow defines a continuous sequence of maps of partonic 2-surface to itself.
2. Physically this means the possibility of a super-conducting phase with order parameter satisfying covariant constancy equation  $D\psi = (d/dt - ieA)\psi = 0$ . This would describe a supra current flowing along flow lines of  $A$ .
3. If the integrability fails to be true, one *cannot* assign Schrödinger time evolution with the flow lines of  $v$ . One might perhaps say that 3-surface behaves like single quantum event not allowing slicing into a continuous Schrödinger time evolution.
4. In TGD Schrödinger amplitudes are replaced by second quantized induced spinor fields. Hence one does not face the problem whether it makes sense to speak about Schrödinger time evolution of complex order parameter along the flow lines of a foliation or not. Also the fact that the "time evolution" for the modified Dirac operator corresponds to single position dependent generalized eigenvalue identified as Higgs expectation same for all transversal modes (essentially  $z^n$  labeled by conformal weight) is crucial since it saves from the problems caused by the possible non-existence of Schrödinger evolution.

#### 4. Extremals of Kähler action

Some comments relating to the interpretation of the classification of the extremals of Kähler action by the dimension of their  $CP_2$  projection are in order. It has been already found that the extremals can be classified according to the dimension  $D$  of the  $CP_2$  projection of space-time sheet in the case that  $A_a = 0$  holds true.



1. For  $D_{CP_2} = 2$  integrability conditions for the vector potential can be satisfied for  $A_a = 0$  so that one has generalized Beltrami flow and one can speak about Schrödinger time evolution associated with the flow lines of vector potential defined by covariant constancy condition  $D\psi = 0$  makes sense. Kähler current is vanishing or light-like. This phase is analogous to a super-conductor or a ferromagnetic phase. For non-vanishing  $A_a$  the Beltrami flow property is lost but the analogy with ferromagnetism makes sense still.
2. For  $D_{CP_2} = 3$  foliations are lost. The phase is dominated by helical structures. This phase is analogous to spin glass phase around phase transition point from ferromagnetic to non-magnetized phase and expected to be important in living matter systems.
3.  $D_{CP_2} = 4$  is analogous to a chaotic phase with vanishing Kähler current and to a phase without magnetization. The interpretation in terms of non-quantum coherent "dead" matter is suggestive.

An interesting question is whether the ordinary 8-D imbedding space which defines one sector of the generalized imbedding space could correspond to  $A_a = 0$  phase. If so, then all states for this sector would be vacua with respect to  $M^4$  quantum numbers.  $M^4$ -trivial zero energy states in this sector could be transformed to non-trivial zero energy states by a leakage to other sectors.

### 2.3.7 About small perturbations of field equations

The study of small perturbations of the known solutions of field equations is a standard manner to get information about the properties of the solutions, their stability in particular. Fourier expansion is the standard manner to do the perturbation theory. In the recent case an appropriate modification of this ansatz might make sense if the solution in question is representable as a map  $M^4_+ \rightarrow CP_2$ , and the perturbations are rapidly varying when compared to the components of the induced metric and Kähler form so that one can make adiabatic approximation and approximate them as being effectively constant. Presumably also restrictions on directions of wave 4-vectors  $k_\mu = (\omega, \vec{k})$  are necessary so that the direction of wave vector adapts to the slowly varying background as in ray optics. Also Hamilton Jacobi structure is expected to modify the most straightforward approach. The four  $CP_2$  coordinates are the dynamical variables so that the situation is relatively simple.

A completely different approach is inspired by the physical picture. In this approach one glues  $CP_2$  type vacuum extremal to a known extremal and tries to deduce the behavior of the deformed extremal in the vicinity of wormhole throat by posing the general conditions on the slicing by light-like 3-surfaces  $Y_1^3$ . This approach is not followed now.

#### Generalized plane waves

Individual plane waves are geometrically very special since they represent a deformation of the space-time surface depending on single coordinate only. Despite this one might hope that plane waves or their appropriate modifications allowing to algebraize the treatment of small perturbations could give useful information also now.

1. Lorentz invariance plus the translational invariance due to the assumption that the induced metric and Kähler form are approximately constant encourage to think that the coordinates reduce Minkowski coordinates locally with the orientation of the local Minkowski frame depending slowly on space-time position. Hamilton Jacobi  $(S^+, S^-, w, \bar{w})$  are a good candidate for this kind of coordinates. The properties of the Hamilton Jacobi structure and of the solution ansatz suggest that excitations are generalized plane waves in longitudinal degrees of freedom only so that four-momentum would be replaced by the longitudinal momentum. In transverse degrees of freedom one might expect that holomorphic plane-waves  $exp(ik_T w)$ , where  $k_T$  is transverse momentum, make algebraization possible.

For time-like longitudinal momenta one can choose the local  $M^4$  coordinates in such a manner that longitudinal momentum reduces to  $(\omega_0, 0)$ , where  $\omega_0$  plays the role of rest mass and is analogous to the plasma frequency serving as an infrared cutoff for plasma waves. In these coordinates the simplest candidates for excitations with time-like momentum would be of form  $\Delta s^k = \epsilon a^k exp(i\omega_0 u)$ , where  $s^k$  are some real coordinates for  $CP_2$ ,  $a^k$  are Fourier coefficients,

and time-like coordinate is defined as  $u = S^+ + S^-$ . The excitations moving with light velocity correspond to  $\omega_0 = 0$ , and one must treat this case separately using plane wave  $\exp(i\omega S^\pm)$ , where  $\omega$  has continuum of values.

2. It is possible that only some preferred  $CP_2$  coordinates are excited in longitudinal degrees of freedom. For  $D_{CP_2} = 3$  ansatz the simplest option is that the complex  $CP_2$  coordinate  $\xi$  depends analytically on  $w$  and the longitudinal  $CP_2$  coordinate  $s$  obeys the plane wave ansatz.  $\xi(w) = a \times \exp(ik_T w)$ , where  $k_T$  is transverse momentum allows the algebraization of the solution ansatz also in the transversal degrees of freedom so that a dispersion relation results. For imaginary values of  $k_T$  and  $\omega$  the equations are real.

### 2. General form for the second variation of the field equations

For time-like four-momentum the second variation of field equations contains three kinds of terms. There are terms quadratic in  $\omega_0$  and coming from the second derivatives of the deformation, terms proportional to  $i\omega_0$  coming from the variation with respect to the derivatives of  $CP_2$  coordinates, and terms which do not depend on  $\omega_0$  and come from the variations of metric and Kähler form with respect to the  $CP_2$  coordinates.

In standard perturbation theory the terms proportional to  $i\omega_0$  would have interpretation as analogs of dissipative terms. This forces to assume that  $\omega_0$  is complex: note that in purely imaginary  $\omega_0$  the equations are real. The basic assumption is that Kähler action is able to mimic dissipation despite the fact that energy and momentum are conserved quantities. The vanishing of the Lorentz force has an interpretation as the vanishing of the dissipative effects. This would suggest that the terms proportional to  $i\omega_0$  vanish for the perturbations of the solution preserving the non-dissipative character of the asymptotic solutions. This might quite well result from the vanishing of the contractions with the deformation of the energy momentum tensor with the second fundamental form and of energy momentum tensor with the deformation of the second fundamental form coming from first derivatives.

Physical intuition would suggest that dissipation-less propagation is possible only along special directions. Thus the vanishing of the linear terms should occur only for special directions of the longitudinal momentum vector, say for light-like four-momenta in the direction of coordinate lines of  $S^+$  or  $S^-$ . Quite generally, the sub-space of allowed four-momenta is expected to depend on position since the components of metric and Kähler form are slowly varying. This dependence is completely analogous with that appearing in the Hamilton Jacobi (ray-optics) approach to the approximate treatment of wave equations and makes sense if the phase of the plane wave varies rapidly as compared to the variation of  $CP_2$  coordinates for the unperturbed solution.

Complex values of  $\omega_0$  are also possible, and would allow to deduce important information about the rate at which small deviations from asymptotia vanish as well as about instabilities of the asymptotic solutions. In particular, for imaginary values of  $\omega_0$  one obtains completely well-defined solution ansatz representing exponentially decaying or increasing perturbation.

### High energy limit

One can gain valuable information by studying the perturbations at the limit of very large four-momentum. At this limit the terms which are quadratic in the components of momentum dominate and come from the second derivatives of the  $CP_2$  coordinates appearing in the second fundamental form. The resulting equations reduce for all  $CP_2$  coordinates to the same condition

$$T^{\alpha\beta} k_\alpha k_\beta = 0 \quad .$$

This condition is generalization of masslessness condition with metric replaced by the energy momentum tensor, which means that light velocity is replaced by an effective light velocity. In fact, energy momentum tensor effectively replaces metric also in the modified Dirac equation whose form is dictated by super symmetry. Light-like four momentum is a rather general solution to the condition and corresponds to  $\omega_0 = 0$  case.

### Reduction of the dispersion relation to the graph of swallowtail catastrophe

Also the general structure of the equations for small perturbations allows to deduce highly non-trivial conclusions about the character of perturbations.

1. The equations for four  $CP_2$  coordinates are simultaneously satisfied if the determinant associated with the equations vanishes. This condition defines a 3-dimensional surface in the 4-dimensional space defined by  $\omega_0$  and coordinates of 3-space playing the role of slowly varying control parameters.  $4 \times 4$  determinant results and corresponds to a polynomial which is of order  $d = 8$  in  $\omega_0$ . If the determinant is real, the polynomial can depend on  $\omega_0^2$  only so that a fourth order polynomial in  $w = \omega_0^2$  results.
2. Only complex roots are possible in the case that the terms linear in  $i\omega_0$  are non-vanishing. One might hope that the linear term vanishes for certain choices of the direction of slowly varying four-momentum vector  $k^\mu(x)$  at least. For purely imaginary values of  $\omega_0$  the equations determinant are real always. Hence catastrophe theoretic description applies in this case at least, and the so called swallow tail [A16] with three control parameters applies to the situation.
3. The general form of the vanishing determinant is

$$D(w, a, b, c) = w^4 - ew^3 - cw^2 - bw - a \quad .$$

The transition from the oscillatory to purely dissipative case changes only the sign of  $w$ . By the shift  $w = \hat{w} + e/4$  the determinant reduces to the canonical form

$$D(\hat{w}, a, b, c) = \hat{w}^4 - c\hat{w}^2 - b\hat{w} - a$$

of the swallowtail catastrophe. This catastrophe has three control variables, which basically correspond to the spatial 3-coordinates on which the induced metric and Kähler form depend. The variation of these coefficients at the space-time sheet of course covers only a finite region of the parameter space of the swallowtail catastrophe. The number of real roots for  $w = \omega_0^2$  is four, two, or none since complex roots appear in complex conjugate pairs for a real polynomial. The general shape of the region of 3-space is that for a portion of swallow tail catastrophe.

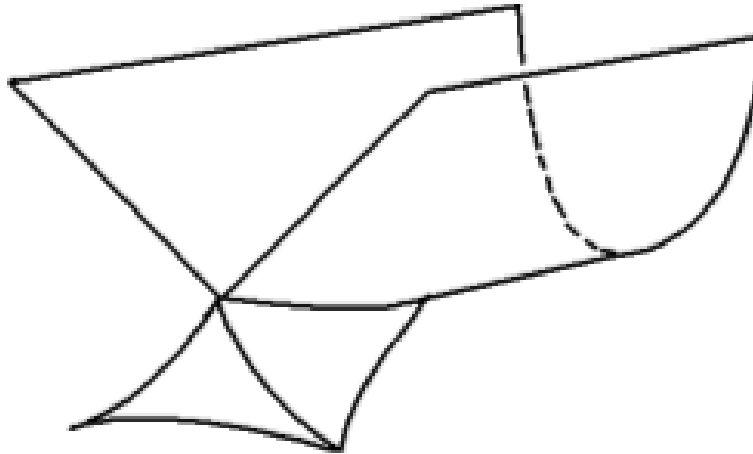

Figure 2.1: The projection of the bifurcation set of the swallowtail catastrophe to the 3-dimensional space of control variables. The potential function has four extrema in the interior of the swallowtail bounded by the triangles, no extrema in the valley above the swallowtail, and 2 extrema elsewhere.

4. The dispersion relation for the "rest mass"  $\omega_0$  (decay rate for the imaginary value of  $\omega_0$ ) has at most four real branches, which conforms with the fact that there are four dynamical variables. In real case  $\omega_0$  is analogous to plasma frequency acting as an infrared cutoff for the frequencies of plasma excitations. To get some grasp on the situation notice that for  $a = 0$  the swallowtail reduces to  $\hat{w} = 0$  and

$$\hat{w}^3 - c\hat{w} - b = 0 \quad ,$$

which represents the cusp catastrophe easy to illustrate in 3-dimensional space. Cusp in turn reduces for  $b = 0$  to  $\hat{w} = 0$  and fold catastrophe  $\hat{w} = \pm\sqrt{c}$ . Thus the catastrophe surface becomes 4-sheeted for  $c \geq 0$  for sufficiently small values of the parameters  $a$  and  $b$ . The possibility of negative values of  $\hat{w}$  in principle allows  $\omega^2 = \hat{w} + e/4 < 0$  solutions identifiable as exponentially decaying or amplified perturbations. At the high frequency limit the 4 branches degenerate to a single branch  $T^{\alpha\beta}k_\alpha k_\beta = 0$ , which as a special case gives light-like four-momenta corresponding to  $\omega_0 = 0$  and the origin of the swallowtail catastrophe.



Figure 2.2: Cusp catastrophe. Vertical direction corresponds to the behavior variable and orthogonal directions to control variables.

5. It is quite possible that the imaginary terms proportional to  $i\omega_0$  cannot be neglected in the time-like case. The interpretation would be as dissipative effects. If these effects are not too large, an approximate description in terms of butterfly catastrophe makes still sense. Note however that the second variation contains besides gravitational terms potentially large dissipative terms coming from the variation of the induced Kähler form and from the variation of  $CP_2$  Christoffel symbols.
6. Additional complications are encountered at the points, where the induced Kähler field vanishes since the second variation vanishes identically at these points. By the arguments represented earlier, these points quite generally represent instabilities.

## 2.4 Vacuum extremals

Vacuum extremals come as two basic types:  $CP_2$  type vacuum extremals for which the induced Kähler field and Kähler action are non-vanishing and the extremals for which the induced Kähler field vanishes. The deformations of both extremals are expected to be of fundamental importance in TGD universe. Vacuum extremals are not gravitational vacua and they are indeed fundamental in TGD inspired cosmology.

### 2.4.1 $CP_2$ type extremals

#### $CP_2$ type vacuum extremals

These extremals correspond to various isometric imbeddings of  $CP_2$  to  $M_+^4 \times CP_2$ . One can also drill holes to  $CP_2$ . Using the coordinates of  $CP_2$  as coordinates for  $X^4$  the imbedding is given by the formula

$$\begin{aligned} m^k &= m^k(u) , \\ m_{kl}\dot{m}^k\dot{m}^l &= 0 , \end{aligned} \tag{2.4.1}$$

where  $u(s^k)$  is an arbitrary function of  $CP_2$  coordinates. The latter condition tells that the curve representing the projection of  $X^4$  to  $M^4$  is light like curve. One can choose the functions  $m^i, i = 1, 2, 3$  freely and solve  $m^0$  from the condition expressing light likeness so that the number of this kind of extremals is very large.

The induced metric and Kähler field are just those of  $CP_2$  and energy momentum tensor  $T^{\alpha\beta}$  vanishes identically by the self duality of the Kähler form of  $CP_2$ . Also the canonical current  $j^\alpha =$

$D_\beta J^{\alpha\beta}$  associated with the Kähler form vanishes identically. Therefore the field equations in the interior of  $X^4$  are satisfied. The field equations are also satisfied on the boundary components of  $CP_2$  type extremal because the non-vanishing boundary term is, besides the normal component of Kähler electric field, also proportional to the projection operator to the normal space and vanishes identically since the induced metric and Kähler form are identical with the metric and Kähler form of  $CP_2$ .

As a special case one obtains solutions for which  $M^4$  projection is light like geodesic. The projection of  $m^0 = \text{constant}$  surfaces to  $CP_2$  is  $u = \text{constant}$  3-submanifold of  $CP_2$ . Geometrically these solutions correspond to a propagation of a massless particle. In a more general case the interpretation as an orbit of a massless particle is not the only possibility. For example, one can imagine a situation, where the center of mass of the particle is at rest and motion occurs along a circle at say  $(m^1, m^2)$  plane. The interpretation as a massive particle is natural. Amusingly, there is nice analogy with the classical theory of Dirac electron: massive Dirac fermion moves also with the velocity of light (zitterbewegung). The quantization of this random motion with light velocity leads to Virasoro conditions and this led to a breakthrough in the understanding of the p-adic QFT limit of TGD. Furthermore, it has turned out that Super Virasoro invariance is a general symmetry of the configuration space geometry and quantum TGD and appears both at the level of imbedding space and space-time surfaces.

The action for all extremals is same and given by the Kähler action for the imbedding of  $CP_2$ . The value of the action is given by

$$S = -\frac{\pi}{8\alpha_K} . \quad (2.4.2)$$

To derive this expression we have used the result that the value of Lagrangian is constant:  $L = 4/R^4$ , the volume of  $CP_2$  is  $V(CP_2) = \pi^2 R^4/2$  and the definition of the Kähler coupling strength  $k_1 = 1/16\pi\alpha_K$  (by definition,  $\pi R$  is the length of  $CP_2$  geodesics). Four-momentum vanishes for these extremals so that they can be regarded as vacuum extremals. The value of the action is negative so that these vacuum extremals are indeed favored by the minimization of the Kähler action. The absolute minimization of Kähler action suggests that ordinary vacuums with vanishing Kähler action density are unstable against the generation of  $CP_2$  type extremals. There are even reasons to expect that  $CP_2$  type extremals are for TGD what black holes are for GRT. Indeed, the nice generalization of the area law for the entropy of black hole [?] supports this view.

In accordance with the basic ideas of TGD topologically condensed vacuum extremals should somehow correspond to massive particles. The properties of the  $CP_2$  type vacuum extremals are in accordance with this interpretation. Although these objects move with a velocity of light, the motion can be transformed to a mere zitterbewegung so that the center of mass motion is trivial. Even the generation of the rest mass could be understood classically as a consequence of the minimization of action. Long range Kähler fields generate negative action for the topologically condensed vacuum extremal (momentum zero massless particle) and Kähler field energy in turn is identifiable as the rest mass of the topologically condensed particle.

An interesting feature of these objects is that they can be regarded as gravitational instantons [A4]. A further interesting feature of  $CP_2$  type extremals is that they carry nontrivial classical color charges. The possible relationship of this feature to color confinement raises interesting questions. Could one model classically the formation of the color singlets to take place through the emission of "colorons": states with zero momentum but non-vanishing color? Could these peculiar states reflect the infrared properties of the color interactions?

#### Are $CP_2$ type non-vacuum extremals possible?

The isometric imbeddings of  $CP_2$  are all vacuum extremals so that these extremals as such cannot correspond to physical particles. One obtains however nonvacuum extremals as deformations of these solutions. There are several types of deformations leading to nonvacuum solutions. In order to describe some of them, recall the expressions of metric and Kähler form of  $CP_2$  in the coordinates  $(r, \Theta, \Psi, \Phi)$  [A13] are given by

$$\begin{aligned}
\frac{ds^2}{R^2} &= \frac{dr^2}{(1+r^2)^2} + \frac{r}{2(1+r^2)^2} (d\Psi + \cos(\Theta)d\Phi)^2 \\
&+ \frac{r^2}{4(1+r^2)} (d\Theta^2 + \sin^2\Theta d\Phi^2) , \\
J &= \frac{r}{(1+r^2)} dr \wedge (d\Psi + \cos(\Theta)d\Phi) \\
&- \frac{r^2}{2(1+r^2)} \sin(\Theta) d\Theta \wedge d\Phi .
\end{aligned} \tag{2.4.3}$$

The scaling of the line element is defined so that  $\pi R$  is the length of the  $CP_2$  geodesic line. Note that  $\Phi$  and  $\Psi$  appear as "cyclic" coordinates in metric and Kähler form: this feature plays important role in the solution ansatz to be described.

Let  $M^4 = M^2 \times E^2$  denote the decomposition of  $M^4$  to a product of 2-dimensional Minkowski space and 2-dimensional Euclidian plane. This decomposition corresponds physically to the decomposition of momentum degrees of freedom for massless particle:  $E^2$  corresponds to polarization degrees of freedom.

There are several types of nonvacuum extremals.

1. "Virtual particle" extremals: the mass spectrum is continuous (also Euclidian momenta are allowed) but these extremals reduce to vacuum extremals in the massless limit.
2. Massless extremals.

Consider first an example of virtual particle extremal. The simplest extremal of this type is obtained in the following form

$$m^k = a^k \Psi + b^k \Phi . \tag{2.4.4}$$

Here  $a^k$  and  $b^k$  are some constant quantities. Field equations are equivalent to the conditions expressing four-momentum conservation and are identically satisfied the reason being that induced metric and Kähler form do not depend on the coordinates  $\Psi$  and  $\Phi$ .

Extremal describes 3-surface, which moves with constant velocity in  $M^4$ . Four-momentum of the solution can be both space and time like. In the massless limit solution however reduces to a vacuum extremal. Therefore the interpretation as an off mass shell massless particle seems appropriate.

Massless extremals are obtained from the following solution ansatz.

$$\begin{aligned}
m^0 &= m^3 = a\Psi + b\Phi , \\
(m^1, m^2) &= (m^1(r, \Theta), m^2(r, \Theta)) .
\end{aligned} \tag{2.4.5}$$

Only  $E^2$  degrees of freedom contribute to the induced metric and the line element is obtained from

$$ds^2 = ds_{CP_2}^2 - (dm^1)^2 - (dm^2)^2 . \tag{2.4.6}$$

Field equations reduce to conservation condition for the components of four-momentum in  $E^2$  plane. By their cyclicity the coordinates  $\Psi$  and  $\Phi$  disappear from field equations and one obtains essentially current conservation condition for two-dimensional field theory defined in space spanned by the coordinates  $r$  and  $\Theta$ .

$$\begin{aligned}
(J_a^i)_{,i} &= 0 , \\
J_a^i &= T^{ij} f_{,j}^a \sqrt{g} .
\end{aligned} \tag{2.4.7}$$

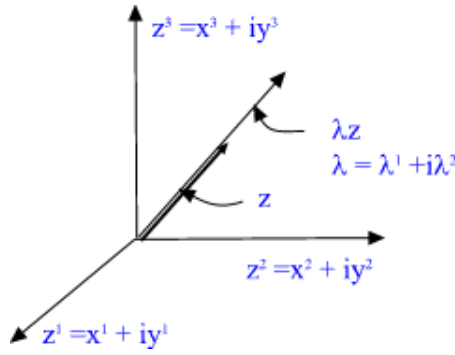

Figure 2.3: Topological sum of  $CP_2$ :s as Feynman graph with lines thickened to four-manifolds

Here the index  $i$  and  $a$  refer to  $r$  and  $\Theta$  and to  $E^2$  coordinates  $m^1$  and  $m^2$  respectively.  $T^{ij}$  denotes the canonical energy momentum tensor associated with Kähler action. One can express the components of  $T^{ij}$  in terms of induced metric and  $CP_2$  metric in the following form

$$T^{ij} = (-g^{ik}g^{jl} + g^{ij}g^{kl}/2)s_{kl} . \quad (2.4.8)$$

This expression holds true for all components of the energy momentum tensor.

Since field equations are essentially two-dimensional conservation conditions they imply that components of momentum currents can be regarded as vector fields of some canonical transformations

$$J_a^i = \varepsilon^{ij} H_{,j}^a , \quad (2.4.9)$$

where  $\varepsilon^{ij}$  denotes two-dimensional constant symplectic form. An open problem is whether one could solve field equations exactly and whether there exists some nonlinear superposition principle for the solutions of these equations. Solutions are massless since transversal momentum densities vanish identically.

Consider as a special case the solution obtained by assuming that one  $E^2$  coordinate is constant and second coordinate is function  $f(r)$  of the variable  $r$  only. Field equations reduce to the following form

$$f_{,r} = \pm \frac{k}{(1+r^2)^{1/3}} \sqrt{r^2 - k^2(1+r^2)^{4/3}} . \quad (2.4.10)$$

The solution is well defined only for sufficiently small values of the parameter  $k$  appearing as integration constant and becomes ill defined at two singular values of the variable  $r$ . Boundary conditions are identically satisfied at the singular values of  $r$  since the radial component of induced metric diverges at these values of  $r$ . The result leads to suspect that the generation of boundary components dynamically is a general phenomenon so that all nonvacuum solutions have boundary components in accordance with basic ideas of TGD.

#### $CP_2 \# CP_2 \# \dots \# CP_2$ :s as generalized Feynman graphs

There are reasons to believe that point like particles might be identified as  $CP_2$  type extremals in TGD approach. Also the geometric counterparts of the massless on mass shell particles and virtual particles have been identified. It is natural to extend this idea to the level of particle interactions: the lines of Feynman diagrams of quantum field theory are thickened to four-manifolds, which are in a good approximation  $CP_2$  type vacuum extremals. This would mean that generalized Feynman graphs are essentially connected sums of  $CP_2$ :s (see Fig. 2.4.1):  $X^4 = CP_2 \# CP_2 \dots \# CP_2$ .

Unfortunately, this picture seems to be oversimplified. First, it is questionable whether the cross sections for the scattering of  $CP_2$  type extremals have anything to do with the cross sections associated with the standard gauge interactions. A naive geometric argument suggests that the cross section should reflect the geometric size of the scattered objects and therefore be of the order of  $CP_2$  radius for topologically non-condensed  $CP_2$  type extremals. The observed cross sections would result at the first level of condensation, where particles are effectively replaced by surfaces with size of order Compton length. Secondly, the  $h_{vac} = -D$  rule, considered in the previous chapter, suggests that only real particles correspond to the  $CP_2$  type extremals whereas virtual particles in general correspond to the vacuum extremals with a vanishing Kähler action. The reason is that the negative exponent of the Kähler action reduces the contribution of the  $CP_2$  type extremals to the functional integral very effectively. Therefore the exchanges of  $CP_2$  type extremals are suppressed by the negative exponent of the Kähler action very effectively so that geometric scattering cross section is obtained.

### 2.4.2 Vacuum extremals with vanishing Kähler field

Vacuum extremals correspond to 4-surfaces with vanishing Kähler field and therefore to gauge field zero configurations of gauge field theory. These surfaces have  $CP_2$  projection, which is Legendre manifold. The condition expressing Legendre manifold property is obtained in the following manner. Kähler potential of  $CP_2$  can be expressed in terms of the canonical coordinates  $(P_i, Q_i)$  for  $CP_2$  as

$$A = \sum_k P_k dQ^k . \quad (2.4.11)$$

The conditions

$$P_k = \partial_{Q^k} f(Q^i) , \quad (2.4.12)$$

where  $f(Q^i)$  is arbitrary function of its arguments, guarantee that Kähler potential is pure gauge. It is clear that canonical transformations, which act as local  $U(1)$  gauge transformations, transform different vacuum configurations to each other so that vacuum degeneracy is enormous. Also  $M_+^4$  diffeomorphisms act as the dynamical symmetries of the vacuum extremals. Some sub-group of these symmetries extends to the isometry group of the configuration space in the proposed construction of the configuration space metric. The vacuum degeneracy is still enhanced by the fact that the topology of the four-surface is practically free.

Vacuum extremals are certainly not absolute minima of the action. For the induced metric having Minkowski signature the generation of Kähler electric fields lowers the action. For Euclidian signature both electric and magnetic fields tend to reduce the action. Therefore the generation of Euclidian regions of space-time is expected to occur.  $CP_2$  type extremals, identifiable as real (as contrast to virtual) elementary particles, can be indeed regarded as these Euclidian regions.

Particle like vacuum extremals can be classified roughly by the number of the compactified dimensions  $D$  having size given by  $CP_2$  length. Thus one has  $D_{CP_2} = 3$  for  $CP_2$  type extremals,  $D_{CP_2} = 2$  for string like objects,  $D_{CP_2} = 1$  for membranes and  $D_{CP_2} = 0$  for pieces of  $M^4$ . As already mentioned, the rule  $h_{vac} = -D$  relating the vacuum weight of the Super Virasoro representation to the number of compactified dimensions of the vacuum extremal is very suggestive.  $D < 3$  vacuum extremals would correspond in this picture to virtual particles, whose contribution to the generalized Feynman diagram is not suppressed by the exponential of Kähler action unlike that associated with the virtual  $CP_2$  type lines.

$M^4$  type vacuum extremals (representable as maps  $M_+^4 \rightarrow CP_2$  by definition) are also expected to be natural idealizations of the space-time at long length scales obtained by smoothing out small scale topological inhomogenities (particles) and therefore they should correspond to space-time of GRT in a reasonable approximation.

The reason would be "Yin-Yang principle".

1. Consider first the option for which Kähler function corresponds to an absolute minimum of Kähler action. Vacuum functional as an exponent of Kähler function is expected to concentrate on those 3-surfaces for which the Kähler action is non-negative. On the other hand, the



requirement that Kähler action is absolute minimum for the space-time associated with a given 3-surface, tends to make the action negative. Therefore the vacuum functional is expected to differ considerably from zero only for 3-surfaces with a vanishing Kähler action per volume. It could also occur that the degeneracy of 3-surfaces with same large negative action compensates the exponent of Kähler function.

2. If preferred extrema correspond to Kähler calibrations or their duals [K72] , Yin-Yang principle is modified to a more local principle. For Kähler calibrations (their duals) the absolute value of action in given region is minimized (maximized). A given region with positive (negative sign) of action density favors Kähler electric (magnetic) fields. In long length scales the average density of Kähler action per four-volume tends to vanish so that Kähler function of the entire universe is expected to be very nearly zero. This regularizes the theory automatically and implies that average Kähler action per volume vanishes. Positive and finite values of Kähler function are of course favored.

In both cases the vanishing of Kähler action per volume in long length scales makes vacuum extremals excellent idealizations for the smoothed out space-time surface. Robertson-Walker cosmologies provide a good example in this respect. As a matter fact the smoothed out space-time is not a mere fictive concept since larger space-time sheets realize it as a essential part of the Universe.

Several absolute minima could be possible and the non-determinism of the vacuum extremals is not expected to be reduced completely. The remaining degeneracy could be even infinite. A good example is provided by the vacuum extremals representable as maps  $M_+^4 \rightarrow D^1$ , where  $D^1$  is one-dimensional curve of  $CP_2$ . This degeneracy could be interpreted as a space-time correlate for the non-determinism of quantum jumps with maximal deterministic regions representing quantum states in a sequence of quantum jumps.

## 2.5 Non-vacuum extremals

### 2.5.1 Cosmic strings

Cosmic strings are extremals of type  $X^2 \times S^2$ , where  $X^2$  is minimal surface in  $M_+^4$  (analogous to the orbit of a bosonic string) and  $S^2$  is the homologically non-trivial geodesic sphere of  $CP_2$ . The action of these extremals is positive and thus absolute minima are certainly not in question. One can however consider the possibility that these extremals are building blocks of the absolute minimum space-time surfaces since the absolute minimization of the Kähler action is global rather than a local principle. Cosmic strings can contain also Kähler charged matter in the form of small holes containing elementary particle quantum numbers on their boundaries and the negative Kähler electric action for a topologically condensed cosmic string could cancel the Kähler magnetic action.

The string tension of the cosmic strings is given by

$$T = \frac{1}{8\alpha_K R^2} \simeq .2210^{-6} \frac{1}{G} , \quad (2.5.1)$$

where  $\alpha_K \simeq \alpha_{em}$  has been used to get the numerical estimate. The string tension is of the same order of magnitude as the string tension of the cosmic strings of GUTs and this leads to the model of the galaxy formation providing a solution to the dark matter puzzle as well as to a model for large voids as caused by the presence of a strongly Kähler charged cosmic string. Cosmic strings play also fundamental role in the TGD inspired very early cosmology.

### 2.5.2 Massless extremals

Massless extremals (or topological light rays) are characterized by massless wave vector  $p$  and polarization vector  $\varepsilon$  orthogonal to this wave vector. Using the coordinates of  $M^4$  as coordinates for  $X^4$  the solution is given as

$$\begin{aligned} s^k &= f^k(u, v) , \\ u &= p \cdot m , & v &= \varepsilon \cdot m , \\ p \cdot \varepsilon &= 0 , & p^2 &= 0 . \end{aligned}$$

$CP_2$  coordinates are arbitrary functions of  $p \cdot m$  and  $\varepsilon \cdot m$ . Clearly these solutions correspond to plane wave solutions of gauge field theories. It is important to notice however that linear super position doesn't hold as it holds in Maxwell phase. Gauge current is proportional to wave vector and its divergence vanishes as a consequence. Also cylindrically symmetric solutions for which the transverse coordinate is replaced with the radial coordinate  $\rho = \sqrt{m_1^2 + m_2^2}$  are possible. In fact,  $v$  can be *any* function of the coordinates  $m^1, m^2$  transversal to the light like vector  $p$ .

Boundary conditions on the boundaries of the massless extremal are satisfied provided the normal component of the energy momentum tensor vanishes. Since energy momentum tensor is of the form  $T^{\alpha\beta} \propto p^\alpha p^\beta$  the conditions  $T^{n\beta} = 0$  are satisfied if the  $M^4$  projection of the boundary is given by the equations of form

$$\begin{aligned} H(p \cdot m, \varepsilon \cdot m, \varepsilon_1 \cdot m) &= 0 \quad , \\ \varepsilon \cdot p &= 0 \quad , \quad \varepsilon_1 \cdot p = 0 \quad , \quad \varepsilon \cdot \varepsilon_1 = 0 \quad . \end{aligned} \quad (2.5.2)$$

where  $H$  is arbitrary function of its arguments. Recall that for  $M^4$  type extremals the boundary conditions are also satisfied if Kähler field vanishes identically on the boundary.

The following argument suggests that there are not very many manners to satisfy boundary conditions in case of  $M^4$  type extremals. The boundary conditions, when applied to  $M^4$  coordinates imply the vanishing of the normal component of energy momentum tensor. Using coordinates, where energy momentum tensor is diagonal, the requirement boils down to the condition that at least one of the eigen values of  $T^{\alpha\beta}$  vanishes so that the determinant  $\det(T^{\alpha\beta})$  must vanish on the boundary: this condition defines 3-dimensional surface in  $X^4$ . In addition, the normal of this surface must have same direction as the eigen vector associated with the vanishing eigen value: this means that three additional conditions must be satisfied and this is in general true in single point only. The boundary conditions in  $CP_2$  coordinates are satisfied provided that the conditions

$$J^{n\beta} J_l^k \partial_\beta s^l = 0$$

are satisfied. The identical vanishing of the normal components of Kähler electric and magnetic fields on the boundary of massless extremal property provides a manner to satisfy all boundary conditions but it is not clear whether there are any other manners to satisfy them.

The characteristic feature of the massless extremals is that in general the Kähler gauge current is non-vanishing. In ordinary Maxwell electrodynamicis this is not possible. This means that these extremals are accompanied by vacuum current, which contains in general case both weak and electromagnetic terms as well as color part.

A possible interpretation of the solution is as the exterior space-time to a topologically condensed particle with vanishing mass described by massless  $CP_2$  type extremal, say photon or neutrino. In general the surfaces in question have boundaries since the coordinates  $s^k$  are bounded this is in accordance with the general ideas about topological condensation. The fact that massless plane wave is associated with  $CP_2$  type extremal combines neatly the wave and particle aspects at geometrical level.

The fractal hierarchy of space-time sheets implies that massless extremals should be interesting also in long length scales. The presence of a light like electromagnetic vacuum current implies the generation of coherent photons and also coherent gravitons are generated since the Einstein tensor is also non-vanishing and light like (proportional to  $k^\alpha k^\beta$ ). Massless extremals play an important role in the TGD based model of bio-system as a macroscopic quantum system. The possibility of vacuum currents is what makes possible the generation of the highly desired coherent photon states.

### 2.5.3 Generalization of the solution ansatz defining massless extremals (MEs)

The solution ansatz for MEs has developed gradually to an increasingly general form and the following formulation is the most general one achieved hitherto. Rather remarkably, it rather closely resembles the solution ansatz for the  $CP_2$  type extremals and has direct interpretation in terms of geometric optics. Equally remarkable is that the latest generalization based on the introduction of the local light cone coordinates was inspired by quantum holography principle.

The solution ansatz for MEs has developed gradually to an increasingly general form and the following formulation is the most general one achieved hitherto. Rather remarkably, it rather closely resembles the solution ansatz for the  $CP_2$  type extremals and has direct interpretation in terms of geometric optics. Equally remarkable is that the latest generalization based on the introduction of the local light cone coordinates was inspired by quantum holography principle.

### Local light cone coordinates

The solution involves a decomposition of  $M^4_+$  tangent space localizing the decomposition of Minkowski space to an orthogonal direct sum  $M^2 \oplus E^2$  defined by light-like wave vector and polarization vector orthogonal to it. This decomposition defines what might be called local light cone coordinates.

1. Denote by  $m^i$  the linear Minkowski coordinates of  $M^4$ . Let  $(S^+, S^-, E^1, E^2)$  denote local coordinates of  $M^4_+$  defining a *local* decomposition of the tangent space  $M^4$  of  $M^4_+$  into a direct *orthogonal* sum  $M^4 = M^2 \oplus E^2$  of spaces  $M^2$  and  $E^2$ . This decomposition has interpretation in terms of the longitudinal and transversal degrees of freedom defined by local light-like four-velocities  $v_{\pm} = \nabla S_{\pm}$  and polarization vectors  $\epsilon_i = \nabla E^i$  assignable to light ray.
2. With these assumptions the coordinates  $(S_{\pm}, E^i)$  define local light cone coordinates with the metric element having the form

$$ds^2 = 2g_{+-}dS^+dS^- + g_{11}(dE^1)^2 + g_{22}(dE^2)^2 . \quad (2.5.3)$$

If complex coordinates are used in transversal degrees of freedom one has  $g_{11} = g_{22}$ .

3. This family of light cone coordinates is not the most general family since longitudinal and transversal spaces are orthogonal. One can also consider light-cone coordinates for which one non-diagonal component, say  $m_{1+}$ , is non-vanishing if the solution ansatz is such that longitudinal and transversal spaces are orthogonal for the induced metric.

### A conformally invariant family of local light cone coordinates

The simplest solutions to the equations defining local light cone coordinates are of form  $S_{\pm} = k \cdot m$  giving as a special case  $S_{\pm} = m^0 \pm m^3$ . For more general solutions of form

$$S_{\pm} = m^0 \pm f(m^1, m^2, m^3) , \quad (\nabla_3 f)^2 = 1 ,$$

where  $f$  is an otherwise arbitrary function, this relationship reads as

$$S^+ + S^- = 2m^0 .$$

This condition defines a natural rest frame. One can integrate  $f$  from its initial data at some two-dimensional  $f = \text{constant}$  surface and solution describes curvilinear light rays emanating from this surface and orthogonal to it. The flow velocity field  $\bar{v} = \nabla f$  is irrotational so that closed flow lines are not possible in a connected region of space and the condition  $\bar{v}^2 = 1$  excludes also closed flow line configuration with singularity at origin such as  $v = 1/\rho$  rotational flow around axis.

One can identify  $E^2$  as a local tangent space spanned by polarization vectors and orthogonal to the flow lines of the velocity field  $\bar{v} = \nabla f(m^1, m^2, m^3)$ . Since the metric tensor of any 3-dimensional space allows always diagonalization in suitable coordinates, one can always find coordinates  $(E^1, E^2)$  such that  $(f, E^1, E^2)$  form orthogonal coordinates for  $m^0 = \text{constant}$  hyperplane. Obviously one can select the coordinates  $E^1$  and  $E^2$  in infinitely many manners.

### Closer inspection of the conditions defining local light cone coordinates

Whether the conformal transforms of the local light cone coordinates  $\{S_{\pm} = m^0 \pm f(m^1, m^2, m^3), E^i\}$  define the only possible compositions  $M^2 \oplus E^2$  with the required properties, remains an open question. The best that one might hope is that any function  $S^+$  defining a family of light-like curves defines a local decomposition  $M^4 = M^2 \oplus E^2$  with required properties.

1. Suppose that  $S^+$  and  $S^-$  define light-like vector fields which are not orthogonal (proportional to each other). Suppose that the polarization vector fields  $\epsilon_i = \nabla E^i$  tangential to local  $E^2$  satisfy the conditions  $\epsilon_i \cdot \nabla S^+ = 0$ . One can formally integrate the functions  $E^i$  from these condition since the initial values of  $E^i$  are given at  $m^0 = \text{constant}$  slice.
2. The solution to the condition  $\nabla S_+ \cdot \epsilon_i = 0$  is determined only modulo the replacement

$$\epsilon_i \rightarrow \hat{\epsilon}_i = \epsilon_i + k \nabla S_+ \quad ,$$

where  $k$  is any function. With the choice

$$k = -\frac{\nabla E^i \cdot \nabla S^-}{\nabla S^+ \cdot \nabla S^-}$$

one can satisfy also the condition  $\hat{\epsilon}_i \cdot \nabla S^- = 0$ .

3. The requirement that also  $\hat{\epsilon}_i$  is gradient is satisfied if the integrability condition

$$k = k(S^+)$$

is satisfied in this case  $\hat{\epsilon}_i$  is obtained by a gauge transformation from  $\epsilon_i$ . The integrability condition can be regarded as an additional, and obviously very strong, condition for  $S^-$  once  $S^+$  and  $E^i$  are known.

4. The problem boils down to that of finding local momentum and polarization directions defined by the functions  $S^+$ ,  $S^-$  and  $E^1$  and  $E^2$  satisfying the orthogonality and integrability conditions

$$(\nabla S^+)^2 = (\nabla S^-)^2 = 0 \quad , \quad \nabla S^+ \cdot \nabla S^- \neq 0 \quad ,$$

$$\nabla S^+ \cdot \nabla E^i = 0 \quad , \quad \frac{\nabla E^i \cdot \nabla S^-}{\nabla S^+ \cdot \nabla S^-} = k_i(S^+) \quad .$$

The number of integrability conditions is 3+3 (all derivatives of  $k_i$  except the one with respect to  $S^+$  vanish): thus it seems that there are not much hopes of finding a solution unless some discrete symmetry relating  $S^+$  and  $S^-$  eliminates the integrability conditions altogether.

A generalization of the spatial reflection  $f \rightarrow -f$  working for the separable Hamilton Jacobi function  $S_{\pm} = m^0 \pm f$  ansatz could relate  $S^+$  and  $S^-$  to each other and trivialize the integrability conditions. The symmetry transformation of  $M_+^4$  must perform the permutation  $S^+ \leftrightarrow S^-$ , preserve the light-likeness property, map  $E^2$  to  $E^2$ , and multiply the inner products between  $M^2$  and  $E^2$  vectors by a mere conformal factor. This encourages the conjecture that all solutions are obtained by conformal transformations from the solutions  $S_{\pm} = m^0 \pm f$ .

### General solution ansatz for MEs for given choice of local light cone coordinates

Consider now the general solution ansatz assuming that a local wave-vector-polarization decomposition of  $M_+^4$  tangent space has been found.

1. Let  $E(S^+, E^1, E^2)$  be an arbitrary function of its arguments: the gradient  $\nabla E$  defines at each point of  $E^2$  an  $S^+$ -dependent (and thus time dependent) polarization direction orthogonal to the direction of local wave vector defined by  $\nabla S^+$ . Polarization vector depends on  $E^2$  position only.
2. Quite a general family of MEs corresponds to the solution family of the field equations having the general form

$$s^k = f^k(S^+, E) \quad ,$$

where  $s^k$  denotes  $CP_2$  coordinates and  $f^k$  is an arbitrary function of  $S^+$  and  $E$ . The solution represents a wave propagating with light velocity and having definite  $S^+$  dependent polarization

in the direction of  $\nabla E$ . By replacing  $S^+$  with  $S^-$  one obtains a dual solution. Field equations are satisfied because energy momentum tensor and Kähler current are light-like so that all tensor contractions involved with the field equations vanish: the orthogonality of  $M^2$  and  $E^2$  is essential for the light-likeness of energy momentum tensor and Kähler current.

3. The simplest solutions of the form  $S_{\pm} = m^0 \pm m^3$ ,  $(E^1, E^2) = (m^1, m^2)$  and correspond to a cylindrical MEs representing waves propagating in the direction of the cylinder axis with light velocity and having polarization which depends on point  $(E^1, E^2)$  and  $S^+$  (and thus time). For these solutions four-momentum is light-like: for more general solutions this cannot be the case. Polarization is in general case time dependent so that both linearly and circularly polarized waves are possible. If  $m^3$  varies in a finite range of length  $L$ , then 'free' solution represents geometrically a cylinder of length  $L$  moving with a light velocity. Of course, ends could be also anchored to the emitting or absorbing space-time surfaces.
4. For the general solution the cylinder is replaced by a three-dimensional family of light like curves and in this case the rectilinear motion of the ends of the cylinder is replaced with a curvilinear motion with light velocity unless the ends are anchored to emitting/absorbing space-time surfaces. The non-rotational character of the velocity flow suggests that the freely moving particle like 3-surface defined by ME cannot remain in a infinite spatial volume. The most general ansatz for MEs should be useful in the intermediate and nearby regions of a radiating object whereas in the far away region radiation solution is expected to decompose to cylindrical ray like MEs for which the function  $f(m^1, m^2, m^2)$  is a linear function of  $m^i$ .
5. One can try to generalize the solution ansatz further by allowing the metric of  $M_{\pm}^4$  to have components of type  $g_{i+}$  or  $g_{i-}$  in the light cone coordinates used. The vanishing of  $T^{11}$ ,  $T^{+1}$ , and  $T^{-}$  is achieved if  $g_{i\pm} = 0$  holds true for the induced metric. For  $s^k = s^k(S^+, E^1)$  ansatz neither  $g_{2\pm}$  nor  $g_{1-}$  is affected by the imbedding so that these components of the metric must vanish for the Hamilton Jacobi structure:

$$ds^2 = 2g_{+-}dS^+dS^- + 2g_{1+}dE^1dS^+ + g_{11}(dE^1)^2 + g_{22}(dE^2)^2 . \quad (2.5.4)$$

$g_{1+} = 0$  can be achieved by an additional condition

$$m_{1+} = s_{kl}\partial_1 s^k \partial_+ s^k . \quad (2.5.5)$$

The diagonalization of the metric seems to be a general aspect of absolute minima. The absence of metric correlations between space-time degrees of freedom for asymptotic self-organization patterns is somewhat analogous to the minimization of non-bound entanglement in the final state of the quantum jump.

### Are the boundaries of space-time sheets quite generally light like surfaces with Hamilton Jacobi structure?

Quantum holography principle naturally generalizes to an approximate principle expected to hold true also in non-cosmological length and time scales.

1. The most general ansatz for topological light rays or massless extremals (MEs) inspired by the quantum holographic thinking relies on the introduction of the notion of local light cone coordinates  $S_+, S_-, E_1, E_2$ . The gradients  $\nabla S_+$  and  $\nabla S_-$  define two light like directions just like Hamilton Jacobi functions define the direction of propagation of wave in geometric optics. The two polarization vector fields  $\nabla E_1$  and  $\nabla E_2$  are orthogonal to the direction of propagation defined by either  $S_+$  or  $S_-$ . Since also  $E_1$  and  $E_2$  can be chosen to be orthogonal, the metric of  $M_{\pm}^4$  can be written locally as  $ds^2 = g_{+-}dS_+dS_- + g_{11}dE_1^2 + g_{22}dE_2^2$ . In the earlier ansatz  $S_+$  and  $S_-$  were restricted to the variables  $k \cdot m$  and  $\tilde{k} \cdot m$ , where  $k$  and  $\tilde{k}$  correspond to light like momentum and its mirror image and  $m$  denotes linear  $M^4$  coordinates: these MEs describe cylindrical structures with constant direction of wave propagation expected to be most important in regions faraway from the source of radiation.

2. Boundary conditions are satisfied if the 3-dimensional boundaries of MEs have one light like direction ( $S_+$  or  $S_-$  is constant). This means that the boundary of ME has metric dimension  $d = 2$  and is characterized by an infinite-dimensional super-symplectic and super-conformal symmetries just like the boundary of the imbedding space  $M_+^4 \times CP_2$ : The boundaries are like moments for mini big bangs (in TGD based fractal cosmology big bang is replaced with a silent whisper amplified to not necessarily so big bang).
3. These observations inspire the conjecture that boundary conditions for  $M^4$  like space-time sheets fixed by the absolute minimization of Kähler action quite generally require that space-time boundaries correspond to light like 3-surfaces with metric dimension equal to  $d = 2$ . This does not yet imply that light like surfaces of imbedding space would take the role of the light cone boundary: these light like surface could be seen only as a special case of causal determinants analogous to event horizons.

### 2.5.4 Maxwell phase

"Maxwell phase" corresponds to small deformations of the  $M^4$  type vacuum extremals. Since energy momentum tensor is quadratic in Kähler field the term proportional to the contraction of the energy momentum tensor with second fundamental form drops from field equations and one obtains in lowest order the following field equations

$$j^\alpha J_{ls,\alpha}^k = 0 . \quad (2.5.6)$$

These equations are satisfied if Maxwell's equations

$$j^\alpha = 0 \quad (2.5.7)$$

hold true. Massless extremals and Maxwell phase clearly exclude each other and it seems that they must corresponds to different space-time sheets.

The explicit construction of these extremals reduces to the task of finding an imbedding for an arbitrary free Maxwell field to  $H$ . One can also allow source terms corresponding to the presence of the point like charges: these should correspond to the regions of the space-time, where the flat space-time approximation of the space-time fails. The regions where the approximation defining the Maxwell phase fails might correspond to a topologically condensed  $CP_2$  type extremals, for example. As a consequence, Kähler field is superposition of radiation type Kähler field and of Coulombic term. A second possibility is the generation of "hole" with similar Coulombic Kähler field.

An important property of the Maxwell phase (also of massless extremals) is its approximate canonical invariance. Canonical transformations do not spoil the extremal property of the four-surface in the approximation used, since it corresponds to a mere  $U(1)$  gauge transformation. This implies the counter part of the vacuum degeneracy, that is, the existence of an enormous number of four-surfaces with very nearly the same action. Also there is an approximate  $Diff(M_+^4)$  invariance.

The canonical degeneracy has some very interesting consequences concerning the understanding of the electro-weak symmetry breaking and color confinement. Kähler field is canonical invariant and satisfies Maxwells equations. This is in accordance with the identification of Kähler field as  $U(1)$  part of the electro-weak gauge field. Electromagnetic gauge field is a superposition of Kähler field and  $Z^0$  field  $\gamma = 3J - \sin^2(\theta_W)Z^0/2$  so that also electromagnetic gauge field is long ranged assuming that  $Z^0$  and  $W^+$  fields are short ranged. These fields are not canonical invariants and their behavior seems to be essentially random, which implies short range correlations and the consequent massivation.

There is an objection against this argument. For the known  $D < 4$  solutions of field equations weak fields are not random at all. These situations could represent asymptotic configurations assignable to space-time sheets. This conforms with the interpretation that weak gauge fields are essentially massless within the asymptotic space-time sheets representing weak bosons. Gauge fields are however transferred between space-time sheets through # contacts modelable as pieces of  $CP_2$  type extremals having  $D_{CP_2} = 4$ . In contrast to Kähler and color gauge fluxes, weak gauge fluxes are not conserved in the Euclidian time evolution between the 3-D causal horizons separating the Euclidian # contact from space-time sheets with Minkowskian signature. This non-conservation implying the loss of coherence

in the transfer of fields between space-time sheets is a plausible mechanism for the loss of correlations and massivation of the weak gauge fields.

Classical gluon fields are proportional to Kähler field and to the Hamiltonians associated with the color isometry generators.

$$g_{\alpha\beta}^A = kH^A J_{\alpha\beta} . \quad (2.5.8)$$

This implies that the direction of gluon fields in color algebra is random. One can always perform a canonical transformation, which reduces to a global color rotation in some arbitrary small region of space-time and reduces to identity outside this region. The proportionality of a gluon field to Kähler form implies that there is a classical long range correlation in  $X^4$  degrees of freedom: in this sense classical gluon fields differ from massive electro-weak fields in Maxwell phase.

### 2.5.5 Stationary, spherically symmetric extremals

The stationary, spherically symmetric extremals of the Kähler action imbeddable in  $M^4 \times S^2$ , where  $S^2$  is geodesic sphere, are the simplest extremals, which one can study as models for the space-time surrounding a topologically condensed particle, say  $CP_2$  type vacuum extremal. In the region near the particle the spherical symmetry is an unrealistic assumption since it excludes the presence of magnetic fields needed to cancel the total Kähler action. The stationarity is also unrealistic assumption since zitterbewegung seems to provide a necessary mechanism for generating Kähler magnetic field and for satisfying boundary conditions. Also the imbeddability to  $M^4 \times S^2$  implies unrealistic relationship between  $Z^0$  and photon charges.

According to the general wisdom, the generation of a Kähler electric field must take place in order to minimize the action and it indeed turns out that the extremal is characterized by essentially  $1/r^2$  Kähler electric field. The necessary presence of a hole or of a topologically condensed object is also demonstrated: it is impossible to find extremals well defined in the region surrounding the origin. It is impossible to satisfy boundary conditions at a hole: this is in accordance with the idea that Euclidian region corresponding to a  $CP_2$  type extremal performing zitterbewegung is generated. In case of  $CP_2$  extremal radius is of the order of the Compton length of the particle and in case of a "hole" of the order of Planck length. The value of the vacuum frequency  $\omega$  is of order of particle mass whereas for macroscopic vacuum extremals it must be of the order of  $1/R$ . This does not lead to a contradiction if the concept of a many-sheeted space-time is accepted.

The Poincare energy of the exterior region is considerably smaller than the gravitational mass; this conforms with the interpretation that gravitational mass is sum of absolute values of positive and negative inertial masses associated with matter and negative energy antimatter. It is quite possible that classical considerations cannot provide much understanding concerning the inertial masses of topologically condensed particles. Electro-weak gauge forces are considerably weaker than the gravitational force at large distances, when the value of the frequency parameter  $\omega$  is of order  $1/R$ . Both these desirable properties fail to be true if  $CP_2$  radius is of order Planck length as believed earlier.

In light of the general ideas about topological condensation it is clear that in planetary length scales these kind of extremals cannot provide a realistic description of space-time. Indeed, spherically symmetric extremals predict a wrong rate for the precession of the perihelion of Mercury. Schwarzschild and Reissner-Nordström metric do this and indeed allow imbedding as vacuum extremals for which the inertial masses of positive energy matter and negative energy antimatter sum up to zero.

This does not yet resolve the interpretational challenge due to the unavoidable long range color and weak gauge fields. A dark matter hierarchy giving rise to a hierarchy of color and electro-weak physics characterized by increasing values of weak and confinement scales explains these fields. # contacts involve a pair of causal horizons at which the Euclidian metric signature of # contact transforms to Minkowskian one. These causal horizons have interpretation as partons so that # contact can be regarded as a bound state of partons bound together by a gravitational instanton ( $CP_2$  type extremal). # contacts provide basic example of dark matter creating long ranged weak fields.

An important result is the correlation between the sign of the vacuum frequency  $\omega$  and that of the Kähler charge, which is of opposite sign for fermions and anti-fermions. This suggests an explanation for matter-antimatter asymmetry. Matter and antimatter condense stably on disjoint regions of the space-time surface at different space-time sheets. Stable antimatter could correspond

to negative time orientation and negative energy. This leads to a model for the primordial generation of matter as spontaneous generation of zero energy # contacts between space-time sheets of opposite time orientations. If  $CP$  conjugation is not exact symmetry, # contacts and their  $CP$  conjugates are created with slightly different rates and this gives rise to  $CP$  asymmetry at each of the two space-time sheets involved. After the splitting of # contacts and subsequent annihilation of particles and antiparticles at each space-time sheet, the two space-time sheets contain only positive energy matter and negative energy antimatter.

### General solution ansatz

The general form of the solution ansatz is obtained by assuming that the space-time surface in question is a sub-manifold of  $M^4 \times S^2$ , where  $S^2$  is the homologically non-trivial geodesic sphere of  $CP_2$ .  $S^2$  is most conveniently realized as  $r = \infty$  surface of  $CP_2$ , for which all values of the coordinate  $\Psi$  correspond to same point of  $CP_2$  so that one can use  $\Theta$  and  $\Phi$  as the coordinates of  $S^2$ .

The solution ansatz is given by the expression

$$\begin{aligned} \cos(\Theta) &= u(r) , \\ \Phi &= \omega t , \\ m^0 &= \lambda t , \\ r_M &= r , \quad \theta_M = \theta , \quad \phi_M = \phi . \end{aligned} \tag{2.5.9}$$

The induced metric is given by the expression

$$ds^2 = \left[ \lambda^2 - \frac{R^2}{4} \omega^2 (1 - u^2) \right] dt^2 - \left( 1 + \frac{R^2}{4} \theta_{,r}^2 \right) dr^2 - r^2 d\Omega^2 . \tag{2.5.10}$$

The value of the parameter  $\lambda$  is fixed by the condition  $g_{tt}(\infty) = 1$ :

$$\lambda^2 - \frac{R^2}{4} \omega^2 (1 - u(\infty)^2) = 1 . \tag{2.5.11}$$

From the condition  $e^0 \wedge e^3 = 0$  the non-vanishing components of the induced Kähler field are given by the expression

$$J_{tr} = \frac{\omega}{4} u_{,r} . \tag{2.5.12}$$

Geodesic sphere property implies that  $Z^0$  and photon fields are proportional to Kähler field:

$$\begin{aligned} \gamma &= (3 - p/2) J , \\ Z^0 &= J . \end{aligned} \tag{2.5.13}$$

From this formula one obtains the expressions

$$\begin{aligned} Q_{em} &= \frac{(3 - p/2)}{4\pi\alpha_{em}} Q_K , \quad Q_Z = \frac{1}{4\pi\alpha_Z} Q , \\ Q &\equiv \frac{J_{tr} 4\pi r^2}{\sqrt{-g_{rr} g_{tt}}} . \end{aligned} \tag{2.5.14}$$

for the electromagnetic and  $Z^0$  charges of the solution using  $e$  and  $g_Z$  as unit.

Field equations can be written as conditions for energy momentum conservation (two equations is in principle all what is needed in the case of geodesic sphere). Energy conservation holds identically true and conservation of momentum, say, in  $z$ -direction gives the equation



$$(T^{rr}z_{,r})_{,r} + (T^{\theta\theta}z_{,\theta})_{,\theta} = 0 . \quad (2.5.15)$$

Using the explicit expressions for the components of the energy momentum tensor

$$\begin{aligned} T^{rr} &= g^{rr}L/2 , \\ T^{\theta\theta} &= -g^{\theta\theta}L/2 , \\ L &= g^{tt}g^{rr}(J_{tr})^2\sqrt{g}/2 , \end{aligned} \quad (2.5.16)$$

and the following notations

$$\begin{aligned} A &= g^{tt}g^{rr}r^2\sqrt{-g_{tt}g_{rr}} , \\ X &\equiv (J_{tr})^2 , \end{aligned} \quad (2.5.17)$$

the field equations reduce to the following form

$$(g^{rr}AX)_{,r} - \frac{2AX}{r} = 0 . \quad (2.5.18)$$

In the approximation  $g^{rr} = 1$  this equation can be readily integrated to give  $AX = C/r^2$ . Integrating Eq. (2.6.7), one obtains integral equation for  $X$

$$J_{tr} = \frac{q}{r_c} (|g_{rr}|^3 g_{tt})^{1/4} \exp\left(\int_{r_c}^r dr \frac{g_{rr}}{r}\right) \frac{1}{r} , \quad (2.5.19)$$

where  $q$  is integration constant, which is related to the charge parameter of the long range Kähler electric field associated with the solution.  $r_c$  denotes the critical radius at which the solution ceases to be well defined.

The inspection of this formula shows that  $J_{tr}$  behaves essentially as  $1/r^2$  Coulomb field. This behavior doesn't depend on the detailed properties of the solution ansatz (for example the imbeddability to  $M^4 \times S^2$ ): stationarity and spherical symmetry is what matters only. The compactness of  $CP_2$  means that stationary, spherically symmetric solution is not possible in the region containing origin. This is in concordance with the idea that either a hole surrounds the origin or there is a topologically condensed  $CP_2$  extremal performing zitterbewegung near the origin and making the solution non-stationary and breaking spherical symmetry.

Second integration gives the following integral equation for  $CP_2$  coordinate  $u = \cos(\Theta)$

$$u(r) = u_0 + \frac{4q}{\omega} \int_{r_c}^r (-g_{rr}^3 g_{tt})^{1/4} \frac{1}{r} \exp\left(\int_{r_c}^r dr \frac{g_{rr}}{r}\right) . \quad (2.5.20)$$

Here  $u_0$  denotes the value of the coordinate  $u$  at  $r = r_0$ .

The form of the field equation suggests a natural iterative procedure for the numerical construction of the solution for large values of  $r$ .

$$u_n(r) = T_{n-1} , \quad (2.5.21)$$

where  $T_{n-1}$  is evaluated using the induced metric associated with  $u_{n-1}$ . The physical content of the approximation procedure is clear: estimate the gravitational effects using lower order solution since these are expected to be small.

A more convenient manner to solve  $u$  is based on Taylor expansion around the point  $V \equiv 1/r = 0$ . The coefficients appearing in the power series expansion  $u = \sum_n u_n A^n V^n$  :  $A = q/\omega$  can be solved by calculating successive derivatives of the integral equation for  $u$ .

The lowest order solution is simply

$$u_0 = u_\infty , \quad (2.5.22)$$

and the corresponding metric is flat metric. In the first order one obtains for  $u(r)$  the expression

$$u = u_\infty - \frac{4q}{\omega r} , \quad (2.5.23)$$

which expresses the fact that Kähler field behaves essentially as  $1/r^2$  Coulomb field. The behavior of  $u$  as a function of  $r$  is identical with that obtained for the imbedding of the Reissner-Nordström solution.

To study the properties of the solution we fix the signs of the parameters in the following manner:

$$u_\infty < 0 , \quad q < 0 , \quad \omega > 0 \quad (2.5.24)$$

(reasons become clear later).

Concerning the behavior of the solution one can consider two different cases.

1) The condition  $g_{tt} > 0$  hold true for all values of  $\Theta$ . In this case  $u$  decreases and the rate of decrease gets faster for small values of  $r$ . This means that in the lowest order the solution becomes certainly ill defined at a critical radius  $r = r_c$  given by the the condition  $u = 1$ : the reason is that  $u$  cannot get values large than one. The expression of the critical radius is given by

$$\begin{aligned} r_c &\geq \frac{4q}{(|u_\infty| + 1)\omega} \\ &= \frac{4\alpha Q_{em}}{(3 - p/2)(|u_\infty| + 1)\omega} . \end{aligned} \quad (2.5.25)$$

The presence of the critical radius for the actual solution is also a necessity as the inspection of the expression for  $J_{tr}$  shows:  $\partial_r \theta$  grows near the origin without bound and  $u = 1$  is reached at some finite value of  $r$ . Boundary conditions require that the quantity  $X = T^{rr} \sqrt{g}$  vanishes at critical radius (no momentum flows through the boundary). Substituting the expression of  $J_{tr}$  from the field equation to  $T^{rr}$  the expression for  $X$  reduces to a form, from which it is clear that  $X$  cannot vanish. The cautious conclusion is that boundary conditions cannot be satisfied and the underlying reason is probably the stationarity and spherical symmetry of the solution. Physical intuition suggests that that  $CP_2$  type extremal performing zitterbewegung is needed to satisfy the boundary conditions.

2)  $g_{tt}$  vanishes for some value of  $\Theta$ . In this case the radial derivative of  $u$  together with  $g_{tt}$  can become zero for some value of  $r = r_c$ . Boundary conditions can be satisfied only provided  $r_c = 0$ . Thus it seems that for the values of  $\omega$  satisfying the condition  $\omega^2 = \frac{4\lambda^2}{R^2 \sin^2(\Theta_0)}$  it might be possible to find a globally defined solution. The study of differential equation for  $u$  however shows that the ansatz doesn't work. The conclusion is that although the boundary is generated it is not possible to satisfy boundary conditions.

A direct calculation of the coefficients  $u_n$  from power series expansion gives the following third order polynomial approximation for  $u$  ( $V = 1/r$ )

$$\begin{aligned} u &= \sum_n u_n A^n V^n , \\ u_0 &= u_\infty (< 0) , \quad u_1 = 1 , \\ u_2 &= K|u_\infty| , \quad u_3 = K(1 + 4K|u_\infty|) , \\ A &\equiv \frac{4q}{\omega} , \quad K \equiv \omega^2 \frac{R^2}{4} . \end{aligned} \quad (2.5.26)$$

The coefficients  $u_2$  and  $u_3$  are indeed positive which means that the value of the critical radius gets larger at least in these orders.

Solution contains three parameters: Kähler electric flux  $Q = 4\pi q$ , parameter  $\omega R$  and parameter  $u_\infty$ . The latter parameters can be regarded as parameters describing the properties of a flat vacuum extremal (lowest order solution) to which particle like solution is glued and are analogous to the parameters describing symmetry broken vacuum in gauge theories.

### Solution is not a realistic model for topological condensation

The solution does not provide realistic model for topological condensation although it gives indirect support for some essential assumptions of TGD based description of Higgs mechanism.

1. When the value of  $\omega$  is of the order of  $CP_2$  mass the solution could be interpreted as the "exterior metric" of a "hole".
  - i) The radius of the hole is of the order of  $CP_2$  length and its mass is of the order of  $CP_2$  mass.
  - ii) Kähler electric field is generated and charge renormalization takes place classically at  $CP_2$  length scales as is clear from the expression of  $Q(r)$ :  $Q(r) \propto (\frac{-g_{rr}}{g_{tt}})^{1/4}$  and charge increases at short distances.
  - iii) The existence of the critical radius is unavoidable but boundary conditions cannot be satisfied. The failure to satisfy boundary conditions might be related to stationarity or to the absence of magnetic field. The motion of the boundary component with velocity of light might be the only manner to satisfy boundary conditions. Second possibility is the breaking of spherical symmetry by the generation of a static magnetic field.
  - iv) The absence of the Kähler magnetic field implies that the Kähler action has an infinite magnitude and the probability of the configuration is zero. A more realistic solution ansatz would break spherical symmetry containing dipole type magnetic field in the nearby region of the hole. The motion of the boundary with a velocity of light could serve as an alternative mechanism for the generation of magnetic field. The third possibility, supported by physical intuition, is that one must give up "hole" type extremal totally.
2. For sufficiently large values of  $r$  and for small values of  $\omega$  (of the order of elementary particle mass scale), the solution might provide an approximate description for the region surrounding elementary particle. Although it is not possible to satisfy boundary conditions the order of magnitude estimate for the size of critical radius ( $r_c \simeq \alpha/\omega$ ) should hold true for more realistic solutions, too. The order of magnitude for the critical radius is smaller than Compton length or larger if the vacuum parameter  $\omega$  is larger than the mass of the particle. In macroscopic length scales the value of  $\omega$  is of order  $1/R$ . This does not lead to a contradiction if the many-sheeted space-time concept is accepted so that  $\omega < m$  corresponds to elementary particle space-time sheet. An unrealistic feature of the solution is that the relationship between  $Z^0$  and em charges is not correct:  $Z^0$  charge should be very small in these length scales.

### Exterior solution cannot be identified as a counter part of Schwarzschild solution

The first thing, which comes into mind is to ask whether one might identify exterior solution as the TGD counterpart of the Schwarzschild solution. The identification of gravitational mass as absolute value of inertial mass which is negative for antimatter implies that vacuum extremals are vacua only with respect to the inertial four-momentum and have a non-vanishing gravitational four-momentum. Hence, in the approximation that the net density of inertial mass vanishes, vacuum extremals provide the proper manner to model matter, and the identification of spherically symmetric extremal as the counterpart of Schwarzschild metric is certainly not possible. It is however useful to show explicitly that the identification is indeed unrealistic. The solution is consistent with Equivalence Principle but the electro-weak gauge forces are considerably weaker than gravitational forces. A wrong perihelion shift is also predicted so that the identification as an exterior metric of macroscopic objects is out of question.

#### 1. Is Equivalence Principle respected?

TGD predicts the possibility of negative classical energy for space-time sheets with negative time orientation, and the only manner to second quantize induced spinor fields without diverging vacuum energy is by assuming that fermions have positive energies and anti-fermions negative energies (vice

versa for phase conjugate fermions). This modifies the original form of Equivalence Principle: gravitational mass can be interpreted as absolute value of inertial mass so that the density of gravitational mass becomes the difference of densities of inertial mass for matter and antimatter (or vice versa). This interpretation leads to an elegant solution of the basic interpretational difficulties created by the conservation of inertial four-momentum and non-conservation of gravitational four-momentum.

The gravitational mass of the solution is determined from the asymptotic behavior of  $g_{tt}$  and is given by

$$M_{gr} = \frac{R^2}{G} \omega q u_\infty , \quad (2.5.27)$$

and is proportional to the Kähler charge  $q$  of the solution.

One can estimate the gravitational mass density also by applying Newtonian approximation to the time component of the metric  $g_{tt} = 1 - 2\Phi_{gr}$ . One obtains  $\Phi_{gr}$  corresponds in the lowest order approximation to a solution of Einstein's equations with the source consisting of a mass point at origin and the energy density of the Kähler electric field. The effective value of gravitational constant is however  $G_{eg} = 8R^2\alpha_K$ . Thus the only sensible interpretation is that the density of Kähler (inertial) energy is only a fraction  $G/G_{eg} \equiv \epsilon \simeq .22 \times 10^{-6}$  of the density of gravitational mass. Hence the densities of positive energy matter and negative energy antimatter cancel each other in a good approximation.

The work with cosmic strings lead to a possible interpretation of the solution as a space-time sheet containing topologically condensed magnetic flux tube idealizable as a point. The negative Kähler electric action must cancel the positive Kähler magnetic action. The resulting structure in turn can condense to a vacuum extremal and Schwartzchild metric is a good approximation for the metric.

One can estimate the contribution of the exterior region ( $r > r_c$ ) to the inertial mass of the system and Equivalence principle requires this to be a fraction of order  $\epsilon$  about the gravitational mass unless the region  $r < r_c$  contains negative inertial mass density, which is of course quite possible. Approximating the metric with a flat metric and using first order approximation for  $u(r)$  the energy reduces just to the standard Coulomb energy of charged sphere with radius  $r_c$

$$\begin{aligned} M_I(ext) &= \frac{1}{32\pi\alpha_K} \int_{r>r_c} E^2 \sqrt{g} d^3x \\ &\simeq \frac{\lambda q^2}{2\alpha_K r_c} , \\ \lambda &= \sqrt{1 + \frac{R^2}{4} \omega^2 (1 - u_\infty^2)} (> 1) . \end{aligned} \quad (2.5.28)$$

Approximating the metric with flat metric the contribution of the region  $r > r_c$  to the energy of the solution is given by

$$M_I(ext) = \frac{1}{8\alpha_K} \lambda q \omega (1 + |u_\infty|) . \quad (2.5.29)$$

The contribution is proportional to Kähler charge as expected. The ratio of external inertial and gravitational masses is given by the expression

$$\begin{aligned} \frac{M_I(ext)}{M_{gr}} &= \frac{G}{4R^2\alpha_K} x , \\ x &= \frac{(1 + |u_\infty|)}{|u_\infty|} > 1 . \end{aligned} \quad (2.5.30)$$

In the approximation used the the ratio of external inertial and gravitational masses is of order  $10^{-6}$  for  $R \sim 10^4 \sqrt{G}$  implied by the p-adic length scale hypothesis and for  $x \sim 1$ . The result conforms with the above discussed interpretation.

2.  $Z^0$  and electromagnetic forces are much weaker than gravitational force

The extremal in question carries Kähler charge and therefore also  $Z^0$  and electromagnetic charge. This implies long range gauge interactions, which ought to be weaker than gravitational interaction in the astrophysical scales. This is indeed the case as the following argument shows.

Expressing the Kähler charge using Planck mass as unit and using the relationships between gauge fields one obtains a direct measure for the strength of the  $Z^0$  force as compared with the strength of gravitational force.

$$Q_Z \equiv \varepsilon_Z M_{gr} \sqrt{G} . \quad (2.5.31)$$

The value of the parameter  $\varepsilon_Z$  should be smaller than one. A transparent form for this condition is obtained, when one writes  $\Phi = \omega t = \Omega m^0 : \Omega = \lambda \omega$ :

$$\varepsilon_Z = \frac{\alpha_K}{\alpha_Z} \frac{1}{\pi(1 + |u_\infty|)\Omega R} \sqrt{\frac{G}{R}} . \quad (2.5.32)$$

The order of magnitude is determined by the values of the parameters  $\sqrt{\frac{G}{R^2}} \sim 10^{-4}$  and  $\Omega R$ . Global Minkowskian signature of the induced metric implies the condition  $\Omega R < 2$  for the allowed values of the parameter  $\Omega R$ . In macroscopic length scales one has  $\Omega R \sim 1$  so that  $Z^0$  force is by a factor of order  $10^{-4}$  weaker than gravitational force. In elementary particle length scales with  $\omega \sim m$  situation is completely different as expected.

### 3. The shift of the perihelion is predicted incorrectly

The  $g_{rr}$  component of Reissner-Nordström and TGD metrics are given by the expressions

$$g_{rr} = -\frac{1}{\left(1 - \frac{2GM}{r}\right)} , \quad (2.5.33)$$

and

$$g_{rr} \simeq 1 - \frac{\frac{Rq}{\omega^2}}{\left[1 - \left(u_\infty - \frac{4q}{\omega r}\right)^2\right] r^4} , \quad (2.5.34)$$

respectively. For reasonable values of  $q$ ,  $\omega$  and  $u_\infty$  the this terms is extremely small as compared with  $1/r$  term so that these expressions differ by  $1/r$  term.

The absence of the  $1/r$  term from  $g_{rr}$ -component of the metric predicts that the shift of the perihelion for elliptic plane orbits is about 2/3 times that predicted by GRT so that the identification as a metric associated with objects of a planetary scale leads to an experimental contradiction. Reissner-Nordström solutions are obtained as vacuum extremals so that standard predictions of GRT are obtained for the planetary motion.

One might hope that the generalization of the form of the spherically symmetric ansatz by introducing the same modification as needed for the imbedding of Reissner-Nordström metric might help. The modification would read as

$$\begin{aligned} \cos(\Theta) &= u(r) , \\ \Phi &= \omega t + f(r) , \\ m^0 &= \lambda t + h(r) , \\ r_M &= r , \quad \theta_M = \theta , \quad \phi_M = \phi . \end{aligned} \quad (2.5.35)$$

The vanishing of the  $g_{tr}$  component of the metric gives the condition

$$\lambda \partial_r h - \frac{R^2}{4} \sin^2(\Theta) \omega \partial_r f = 0 . \quad (2.5.36)$$

The expression for the radial component of the metric transforms to

$$g_{rr} \simeq \partial_r h^2 - 1 - \frac{R^2}{4} (\partial_r \Theta)^2 - \frac{R^2}{4} \sin^2(\Theta) \partial_r f^2, \quad (2.5.37)$$

Essentially the same perihelion shift as for Schwarzschild metric is obtained if  $g_{rr}$  approaches asymptotically to its expression for Schwarzschild metric. This is guaranteed if the following conditions hold true:

$$f(r)_{r \rightarrow \infty} \rightarrow \omega r, \quad \Lambda^2 - 1 = \frac{R^2 \omega^2}{4} \sin^2(\Theta_\infty) \ll \frac{2GM}{\langle r \rangle}. \quad (2.5.38)$$

In the second equation  $\langle r \rangle$  corresponds to the average radius of the planetary orbit.

The field equations for this ansatz can be written as conditions for energy momentum and color charge conservation. Two equations are enough to determine the functions  $\Theta(r)$  and  $f(r)$ . The equation for momentum conservation is same as before. Second field equation corresponds to the conserved isometry current associated with the color isometry  $\Phi \rightarrow \Phi + \epsilon$  and gives equation for  $f$ .

$$[T^{rr} f_{,r} s_{\Phi\Phi} \sqrt{g}]_{,r} = 0. \quad (2.5.39)$$

The conservation laws associated with other infinitesimal  $SU(2)$  rotations of  $S^2_f$  should be satisfied identically. This equation can be readily integrated to give

$$T^{rr} f_{,r} s_{\Phi\Phi} \sqrt{g_{tt} g_{rr}} = \frac{C}{r^2}. \quad (2.5.40)$$

Unfortunately, the result is inconsistent with the  $1/r^4$  behavior of  $T^{rr}$  and  $f \rightarrow \omega r$  implies by correct red shift.

It seems that the only possible way out of the difficulty is to replace spherical symmetry with a symmetry with respect to the rotations around z-axis. The simplest modification of the solution ansatz is as follows:

$$m^0 = \lambda t + h(\rho), \quad \Phi = \omega t + k\rho.$$

Thanks to the linear dependence of  $\Phi$  on  $\rho$ , the conservation laws for momentum and color isospin reduce to the same condition. The ansatz induces a small breaking of spherical symmetry by adding to  $g_{\rho\rho}$  the term

$$(\partial_\rho h)^2 - \frac{R^2}{4} \sin^2(\Theta) k^2.$$

One might hope that in the plane  $\theta = \pi/2$ , where  $r = \rho$  holds true, the ansatz could behave like Schwarzschild metric if the conditions discussed above are posed (including the condition  $k = \omega$ ). The breaking of the spherical symmetry in the planetary system would be coded already to the gravitational field of Sun.

Also the study of the imbeddings of Reissner-Nordström metric as vacuum extremals and the investigation of spherically symmetric (inertial) vacuum extremals for which gravitational four-momentum is conserved [K77] leads to the conclusion that the loss of spherical symmetry due to rotation is inevitable characteristic of realistic solutions.

### 2.5.6 Maxwell hydrodynamics as a toy model for TGD

The field equations of TGD are extremely non-linear and all known solutions have been discovered by symmetry arguments. Chern-Simons term plays essential role also in the construction of solutions of field equations and at partonic level defines braiding for light-like partonic 3-surfaces expected to play key role in the construction of S-matrix. The inspiration for this section came from Terence Tao's blog posting *2006 ICM: Etienne Ghys, Knots and dynamics* [?] giving an elegant summary about amazing mathematical results related to knots, links, braids and hydrodynamical flows in dimension  $D = 3$ . Posting tells about really amazing mathematical results related to knots.

### Chern-Simons term as helicity invariant

Tao mentions helicity as an invariant of fluid flow. Chern-Simons action defined by the induced Kähler gauge potential for light-like 3-surfaces has interpretation as helicity when Kähler gauge potential is identified as fluid velocity. This flow can be continued to the interior of space-time sheet. Also the dual of the induced Kähler form defines a flow at the light-like partonic surfaces but not in the interior of space-time sheet. The lines of this flow can be interpreted as magnetic field lines. This flow is incompressible and represents a conserved charge (Kähler magnetic flux).

The question is which of these flows should define number theoretical braids. Perhaps both of them can appear in the definition of S-matrix and correspond to different kinds of partonic matter (electric/magnetic charges, quarks/leptons?,...). Second kind of matter could not flow in the interior of space-time sheet. Or could interpretation in terms of electric magnetic duality make sense?

Helicity is not gauge invariant and this is as it must be in TGD framework since  $CP_2$  symplectic transformations induce  $U(1)$  gauge transformation, which deforms space-time surface and modifies induced metric as well as classical electroweak fields defined by induced spinor connection. Gauge degeneracy is transformed to spin glass degeneracy.

### Maxwell hydrodynamics

In TGD Maxwell's equations are replaced with field equations which express conservation laws and are thus hydrodynamical in character. With this background the idea that the analogy between gauge theory and hydrodynamics might be applied also in the reverse direction is natural. Hence one might ask what kind of relativistic hydrodynamics results if assumes that the action principle is Maxwell action for the four-velocity  $u^\alpha$  with the constraint term saying that light velocity is maximal signal velocity.

1. For massive particles the length of four-velocity equals to 1:  $u^\alpha u_\alpha = 1$ . In massless case one has  $u^\alpha u_\alpha = 0$ . Geometrically this means that one has sigma model with target space which is 3-D Lobatschevski space or at light-cone boundary. This condition means the addition of constraint term

$$\lambda(u^\alpha u_\alpha - \epsilon) \tag{2.5.41}$$

to the Maxwell action.  $\epsilon = 1/0$  holds for massive/massless flow. In the following the notation of electrodynamics is used to make easier the comparison with electrodynamics.

2. The constraint term destroys gauge invariance by allowing to express  $A^0$  in terms of  $A^i$  but in general the constraint is not equivalent to a choice of gauge in electrodynamics since the solutions to the field equations with constraint term are not solutions of field equations without it. One obtains field equations for an effectively massive em field with Lagrange multiplier  $\lambda$  having interpretation as photon mass depending on space-time point:

$$\begin{aligned} j^\alpha &= \partial_\beta F^{\alpha\beta} = \lambda A^\alpha , \\ A^\alpha &\equiv u^\alpha , \quad F^{\alpha\beta} = \partial^\beta A^\alpha - \partial^\alpha A^\beta . \end{aligned} \tag{2.5.42}$$

3. In electrodynamic context the natural interpretation would be in terms of spontaneous massivation of photon and seems to occur for both values of  $\epsilon$ . The analog of em current given by  $\lambda A^\alpha$  is in general non-vanishing and conserved. This conservation law is quite strong additional constraint on the hydrodynamics. What is interesting is that breaking of gauge invariance does not lead to a loss of charge conservation.
4. One can solve  $\lambda$  by contracting the equations with  $A_\alpha$  to obtain

$$\lambda = j^\alpha A_\alpha$$

for  $\epsilon = 1$ . For  $\epsilon = 0$  one obtains

$$j^\alpha A_\alpha = 0$$

stating that the field does not dissipate energy:  $\lambda$  can be however non-vanishing unless field equations imply  $j^\alpha = 0$ . One can say that for  $\epsilon = 0$  spontaneous massivation can occur. For  $\epsilon = 1$  massivation is present from the beginning and dissipation rate determines photon mass: a natural interpretation for  $\epsilon = 1$  would be in terms of thermal massivation of photon. Non-tachyonicity fixes the sign of the dissipation term so that the thermodynamical arrow of time is fixed by causality.

5. For  $\epsilon = 0$  massless plane wave solutions are possible and one has

$$\partial_\alpha \partial_\beta A^\beta = \lambda A_\alpha .$$

$\lambda = 0$  is obtained in Lorentz gauge which is consistent with the condition  $\epsilon = 0$ . Also superpositions of plane waves with same polarization and direction of propagation are solutions of field equations: these solutions represent dispersionless precisely targeted pulses. For superpositions of plane waves  $\lambda$  with 4-momenta, which are not all parallel  $\lambda$  is non-vanishing so that non-linear self interactions due to the constraint can be said to induce massivation. In asymptotic states for which gauge symmetry is not broken one expects a decomposition of solutions to regions of space-time carrying this kind of pulses, which brings in mind final states of particle reactions containing free photons with fixed polarizations.

6. Gradient flows satisfying the conditions

$$A_\alpha = \partial_\alpha \Phi , \quad A^\alpha A_\alpha = \epsilon \tag{2.5.43}$$

give rise to identically vanishing hydrodynamical gauge fields and  $\lambda = 0$  holds true. These solutions are vacua since energy momentum tensor vanishes identically. There is huge number of this kind of solutions and spin glass degeneracy suggests itself. Small deformations of these vacuum flows are expected to give rise to non-vacuum flows.

7. The counterparts of charged solutions are of special interest. For  $\epsilon = 0$  the solution  $(u^0, u^r) = (Q/r)(1, 1)$  is a solution of field equations outside origin and corresponds to electric field of a point charge  $Q$ . In fact, for  $\epsilon = 0$  any ansatz  $(u^0, u^r) = f(r)(1, 1)$  satisfies field equations for a suitable choice of  $\lambda(r)$  since the ratio of equations associate with  $j^0$  and  $j^r$  gives an equation which is trivially satisfied. For  $\epsilon = 1$  the ansatz  $(u^0, u^r) = (\cosh(u), \sinh(u))$  expressing solution in terms of hyperbolic angle linearizes the field equation obtained by dividing the equations for  $j^0$  and  $j^r$  to eliminate  $\lambda$ . The resulting equation is

$$\partial_r^2 u + \frac{2\partial_r u}{r} = 0$$

for ordinary Coulomb potential and one obtains  $(u^0, u^r) = (\cosh(u_0 + k/r), \sinh(u_0 + k/r))$ . The charge of the solution at the limit  $r \rightarrow \infty$  approaches to the value  $Q = \sinh(u_0)k$  and diverges at the limit  $r \rightarrow 0$ . The charge increases exponentially as a function of  $1/r$  near origin rather than logarithmically as in QED and the interpretation in terms of thermal screening suggests itself. Hyperbolic ansatz might simplify considerably the field equations also in the general case.

### Similarities with TGD

There are strong similarities with TGD which suggests that the proposed model might provide a toy model for the dynamics defined by Kähler action.



1. Also in TGD field equations are essentially hydrodynamical equations stating the conservation of various isometry charges. Gauge invariance is broken for the induced Kähler field although Kähler charge is conserved. There is huge vacuum degeneracy corresponding to vanishing of induced Kähler field and the interpretation is in terms of spin glass degeneracy.
2. Also in TGD dissipation rate vanishes for the known solutions of field equations and a possible interpretation is as space-time correlates for asymptotic non-dissipating self organization patterns.
3. In TGD framework massless extremals represent the analogs for superpositions of plane waves with fixed polarization and propagation direction and representing targeted and dispersionless propagation of signal. Gauge currents are light-like and non-vanishing for these solutions. The decomposition of space-time surface to space-time sheets representing particles is much more general counterpart for the asymptotic solutions of Maxwell hydrodynamics with vanishing  $\lambda$ .
4. In TGD framework one can consider the possibility that the four-velocity assignable to a macroscopic quantum phase is proportional to the induced Kähler gauge potential. In this kind of situation one could speak of a quantal variant of Maxwell hydrodynamics, at least for light-like partonic 3-surfaces. For instance, the condition

$$D^\alpha D_\alpha \Psi = 0 \quad , \quad D_\alpha \Psi = (\partial_\alpha - iq_K A_\alpha) \Psi$$

for the order parameter of the quantum phase corresponds at classical level to the condition  $p^\alpha = q_K Q^\alpha + l^\alpha$ , where  $q_K$  is Kähler charge of fermion and  $l^\alpha$  is a light-like vector field naturally assignable to the partonic boundary component. This gives  $u^\alpha = (q_K Q^\alpha + l^\alpha)/m$ ,  $m^2 = p^\alpha p_\alpha$ , which is somewhat more general condition. The expressibility of  $u^\alpha$  in terms of the vector fields provided by the induced geometry is very natural.

The value  $\epsilon$  depends on space-time region and it would seem that also  $\epsilon = -1$  is possible meaning tachyonicity and breaking of causality. Kähler gauge potential could however have a time-like pure gauge component in  $M^4$  possibly saving the situation. The construction of quantum TGD at parton level indeed forces to assume that Kähler gauge potential has Lorentz invariant  $M^4$  component  $A_a = \text{constant}$  in the direction of the light-cone proper time coordinate axis  $a$ . Note that the decomposition of configuration space to sectors consisting of space-time sheets inside future or past light-cone of  $M^4$  is an essential element of the construction of configuration space geometry and does not imply breaking of Poincare invariance. Without this component  $u_\alpha u^\alpha$  could certainly be negative. The contribution of  $M^4$  component could prevent this for preferred extremals.

If TGD is taken seriously, these similarities force to ask whether Maxwell hydrodynamics might be interpreted as a nonlinear variant of electrodynamics. Probably not: in TGD em field is proportional to the induced Kähler form only in special cases and is in general non-vanishing also for vacuum extremals.

## 2.6 Weak form electric-magnetic duality and its implications

The notion of electric-magnetic duality [?] was proposed first by Olive and Montonen and is central in  $\mathcal{N} = 4$  supersymmetric gauge theories. It states that magnetic monopoles and ordinary particles are two different phases of theory and that the description in terms of monopoles can be applied at the limit when the running gauge coupling constant becomes very large and perturbation theory fails to converge. The notion of electric-magnetic self-duality is more natural since for  $CP_2$  geometry Kähler form is self-dual and Kähler magnetic monopoles are also Kähler electric monopoles and Kähler coupling strength is by quantum criticality renormalization group invariant rather than running coupling constant. The notion of electric-magnetic (self-)duality emerged already two decades ago in the attempts to formulate the Kähler geometric of world of classical worlds. Quite recently a considerable step of progress took place in the understanding of this notion [?]. What seems to be essential is that one adopts a weaker form of the self-duality applying at partonic 2-surfaces. What this means will be discussed in the sequel.

Every new idea must be of course taken with a grain of salt but the good sign is that this concept leads to precise predictions. The point is that elementary particles do not generate monopole fields in macroscopic length scales: at least when one considers visible matter. The first question is whether elementary particles could have vanishing magnetic charges: this turns out to be impossible. The next question is how the screening of the magnetic charges could take place and leads to an identification of the physical particles as string like objects identified as pairs magnetic charged wormhole throats connected by magnetic flux tubes.

1. The first implication is a new view about electro-weak massivation reducing it to weak confinement in TGD framework. The second end of the string contains particle having electroweak isospin neutralizing that of elementary fermion and the size scale of the string is electro-weak scale would be in question. Hence the screening of electro-weak force takes place via weak confinement realized in terms of magnetic confinement.
2. This picture generalizes to the case of color confinement. Also quarks correspond to pairs of magnetic monopoles but the charges need not vanish now. Rather, valence quarks would be connected by flux tubes of length of order hadron size such that magnetic charges sum up to zero. For instance, for baryonic valence quarks these charges could be  $(2, -1, -1)$  and could be proportional to color hyper charge.
3. The highly non-trivial prediction making more precise the earlier stringy vision is that elementary particles are string like objects in electro-weak scale: this should become manifest at LHC energies.
4. The weak form electric-magnetic duality together with Beltrami flow property of Kähler leads to the reduction of Kähler action to Chern-Simons action so that TGD reduces to almost topological QFT and that Kähler function is explicitly calculable. This has enormous impact concerning practical calculability of the theory.
5. One ends up also to a general solution ansatz for field equations from the condition that the theory reduces to almost topological QFT. The solution ansatz is inspired by the idea that all isometry currents are proportional to Kähler current which is integrable in the sense that the flow parameter associated with its flow lines defines a global coordinate. The proposed solution ansatz would describe a hydrodynamical flow with the property that isometry charges are conserved along the flow lines (Beltrami flow). A general ansatz satisfying the integrability conditions is found. The solution ansatz applies also to the extremals of Chern-Simons action and and to the conserved currents associated with the modified Dirac equation defined as contractions of the modified gamma matrices between the solutions of the modified Dirac equation. The strongest form of the solution ansatz states that various classical and quantum currents flow along flow lines of the Beltrami flow defined by Kähler current (Kähler magnetic field associated with Chern-Simons action). Intuitively this picture is attractive. A more general ansatz would allow several Beltrami flows meaning multi-hydrodynamics. The integrability conditions boil down to two scalar functions: the first one satisfies massless d'Alembert equation in the induced metric and the the gradients of the scalar functions are orthogonal. The interpretation in terms of momentum and polarization directions is natural.
6. The general solution ansatz works for induced Kähler Dirac equation and Chern-Simons Dirac equation and reduces them to ordinary differential equations along flow lines. The induced spinor fields are simply constant along flow lines of induced spinor field for Dirac equation in suitable gauge. Also the generalized eigen modes of the modified Chern-Simons Dirac operator can be deduced explicitly if the throats and the ends of space-time surface at the boundaries of  $CD$  are extremals of Chern-Simons action. Chern-Simons Dirac equation reduces to ordinary differential equations along flow lines and one can deduce the general form of the spectrum and the explicit representation of the Dirac determinant in terms of geometric quantities characterizing the 3-surface (eigenvalues are inversely proportional to the lengths of strands of the flow lines in the effective metric defined by the modified gamma matrices).

### 2.6.1 Could a weak form of electric-magnetic duality hold true?

Holography means that the initial data at the partonic 2-surfaces should fix the configuration space metric. A weak form of this condition allows only the partonic 2-surfaces defined by the wormhole throats at which the signature of the induced metric changes. A stronger condition allows all partonic 2-surfaces in the slicing of space-time sheet to partonic 2-surfaces and string world sheets. Number theoretical vision suggests that hyper-quaternionicity *resp.* co-hyperquaternionicity constraint could be enough to fix the initial values of time derivatives of the imbedding space coordinates in the space-time regions with Minkowskian *resp.* Euclidian signature of the induced metric. This is a condition on modified gamma matrices and hyper-quaternionicity states that they span a hyper-quaternionic sub-space.

#### Definition of the weak form of electric-magnetic duality

One can also consider alternative conditions possibly equivalent with this condition. The argument goes as follows.

1. The expression of the matrix elements of the metric and Kähler form of  $WCW$  in terms of the Kähler fluxes weighted by Hamiltonians of  $\delta M_{\pm}^4$  at the partonic 2-surface  $X^2$  looks very attractive. These expressions however carry no information about the 4-D tangent space of the partonic 2-surfaces so that the theory would reduce to a genuinely 2-dimensional theory, which cannot hold true. One would like to code to the  $WCW$  metric also information about the electric part of the induced Kähler form assignable to the complement of the tangent space of  $X^2 \subset X^4$ .
2. Electric-magnetic duality of the theory looks a highly attractive symmetry. The trivial manner to get electric magnetic duality at the level of the full theory would be via the identification of the flux Hamiltonians as sums of of the magnetic and electric fluxes. The presence of the induced metric is however troublesome since the presence of the induced metric means that the simple transformation properties of flux Hamiltonians under symplectic transformations -in particular color rotations- are lost.
3. A less trivial formulation of electric-magnetic duality would be as an initial condition which eliminates the induced metric from the electric flux. In the Euclidian version of 4-D YM theory this duality allows to solve field equations exactly in terms of instantons. This approach involves also quaternions. These arguments suggest that the duality in some form might work. The full electric magnetic duality is certainly too strong and implies that space-time surface at the partonic 2-surface corresponds to piece of  $CP_2$  type vacuum extremal and can hold only in the deep interior of the region with Euclidian signature. In the region surrounding wormhole throat at both sides the condition must be replaced with a weaker condition.
4. To formulate a weaker form of the condition let us introduce coordinates  $(x^0, x^3, x^1, x^2)$  such  $(x^1, x^2)$  define coordinates for the partonic 2-surface and  $(x^0, x^3)$  define coordinates labeling partonic 2-surfaces in the slicing of the space-time surface by partonic 2-surfaces and string world sheets making sense in the regions of space-time sheet with Minkowskian signature. The assumption about the slicing allows to preserve general coordinate invariance. The weakest condition is that the generalized Kähler electric fluxes are apart from constant proportional to Kähler magnetic fluxes. This requires the condition

$$J^{03} \sqrt{g_4} = K J_{12} . \quad (2.6.1)$$

A more general form of this duality is suggested by the considerations of [?] reducing the hierarchy of Planck constants to basic quantum TGD and also reducing Kähler function for preferred extremals to Chern-Simons terms [?] at the boundaries of  $CD$  and at light-like wormhole throats. This form is following

$$J^{n\beta} \sqrt{g_4} = K \epsilon \times \epsilon^{n\beta\gamma\delta} J_{\gamma\delta} \sqrt{g_4} . \quad (2.6.2)$$

Here the index  $n$  refers to a normal coordinate for the space-like 3-surface at either boundary of  $CD$  or for light-like wormhole throat.  $\epsilon$  is a sign factor which is opposite for the two ends of  $CD$ . It could be also opposite of opposite at the opposite sides of the wormhole throat. Note that the dependence on induced metric disappears at the right hand side and this condition eliminates the potentials singularity due to the reduction of the rank of the induced metric at wormhole throat.

- Information about the tangent space of the space-time surface can be coded to the configuration space metric with loosing the nice transformation properties of the magnetic flux Hamiltonians if Kähler electric fluxes or sum of magnetic flux and electric flux satisfying this condition are used and  $K$  is symplectic invariant. Using the sum

$$J_e + J_m = (1 + K)J_{12} , \quad (2.6.3)$$

where  $J$  denotes the Kähler magnetic flux, , makes it possible to have a non-trivial configuration space metric even for  $K = 0$ , which could correspond to the ends of a cosmic string like solution carrying only Kähler magnetic fields. This condition suggests that it can depend only on Kähler magnetic flux and other symplectic invariants. Whether local symplectic coordinate invariants are possible at all is far from obvious, If the slicing itself is symplectic invariant then  $K$  could be a non-constant function of  $X^2$  depending on string world sheet coordinates. The light-like radial coordinate of the light-cone boundary indeed defines a symplectically invariant slicing and this slicing could be shifted along the time axis defined by the tips of  $CD$ .

### Electric-magnetic duality physically

What could the weak duality condition mean physically? For instance, what constraints are obtained if one assumes that the quantization of electro-weak charges reduces to this condition at classical level?

- The first thing to notice is that the flux of  $J$  over the partonic 2-surface is analogous to magnetic flux

$$Q_m = \frac{e}{\hbar} \oint B dS = n .$$

$n$  is non-vanishing only if the surface is homologically non-trivial and gives the homology charge of the partonic 2-surface.

- The expressions of classical electromagnetic and  $Z^0$  fields in terms of Kähler form [?] , [?] read as

$$\begin{aligned} \gamma &= \frac{eF_{em}}{\hbar} = 3J - \sin^2(\theta_W)R_{03} , \\ Z^0 &= \frac{g_Z F_Z}{\hbar} = 2R_{03} . \end{aligned} \quad (2.6.4)$$

Here  $R_{03}$  is one of the components of the curvature tensor in vielbein representation and  $F_{em}$  and  $F_Z$  correspond to the standard field tensors. From this expression one can deduce

$$J = \frac{e}{3\hbar} F_{em} + \sin^2(\theta_W) \frac{g_Z}{6\hbar} F_Z . \quad (2.6.5)$$

3. The weak duality condition when integrated over  $X^2$  implies

$$\begin{aligned} \frac{e^2}{3\hbar}Q_{em} + \frac{g_Z^2 p}{6}Q_{Z,V} &= K \oint J = Kn \ , \\ Q_{Z,V} &= \frac{I_V^3}{2} - Q_{em} \ , \ p = \sin^2(\theta_W) \ . \end{aligned} \quad (2.6.6)$$

Here the vectorial part of the  $Z^0$  charge rather than as full  $Z^0$  charge  $Q_Z = I_L^3 + \sin^2(\theta_W)Q_{em}$  appears. The reason is that only the vectorial isospin is same for left and right handed components of fermion which are in general mixed for the massive states.

The coefficients are dimensionless and expressible in terms of the gauge coupling strengths and using  $\hbar = r\hbar_0$  one can write

$$\begin{aligned} \alpha_{em}Q_{em} + p\frac{\alpha_Z}{2}Q_{Z,V} &= \frac{3}{4\pi} \times rnK \ , \\ \alpha_{em} &= \frac{e^2}{4\pi\hbar_0} \ , \ \alpha_Z = \frac{g_Z^2}{4\pi\hbar_0} = \frac{\alpha_{em}}{p(1-p)} \ . \end{aligned} \quad (2.6.7)$$

4. There is a great temptation to assume that the values of  $Q_{em}$  and  $Q_Z$  correspond to their quantized values and therefore depend on the quantum state assigned to the partonic 2-surface. The linear coupling of the modified Dirac operator to conserved charges implies correlation between the geometry of space-time sheet and quantum numbers assigned to the partonic 2-surface. The assumption of standard quantized values for  $Q_{em}$  and  $Q_Z$  would be also seen as the identification of the fine structure constants  $\alpha_{em}$  and  $\alpha_Z$ . This however requires weak isospin invariance.

### The value of $K$ from classical quantization of Kähler electric charge

The value of  $K$  can be deduced by requiring classical quantization of Kähler electric charge.

1. The condition that the flux of  $F^{03} = (\hbar/g_K)J^{03}$  defining the counterpart of Kähler electric field equals to the Kähler charge  $g_K$  would give the condition  $K = g_K^2/\hbar$ , where  $g_K$  is Kähler coupling constant which should invariant under coupling constant evolution by quantum criticality. Within experimental uncertainties one has  $\alpha_K = g_K^2/4\pi\hbar_0 = \alpha_{em} \simeq 1/137$ , where  $\alpha_{em}$  is finite structure constant in electron length scale and  $\hbar_0$  is the standard value of Planck constant.
2. The quantization of Planck constants makes the condition highly non-trivial. The most general quantization of  $r$  is as rationals but there are good arguments favoring the quantization as integers corresponding to the allowance of only singular coverings of  $CD$  and  $CP_2$ . The point is that in this case a given value of Planck constant corresponds to a finite number pages of the "Big Book". The quantization of the Planck constant implies a further quantization of  $K$  and would suggest that  $K$  scales as  $1/r$  unless the spectrum of values of  $Q_{em}$  and  $Q_Z$  allowed by the quantization condition scales as  $r$ . This is quite possible and the interpretation would be that each of the  $r$  sheets of the covering carries (possibly same) elementary charge. Kind of discrete variant of a full Fermi sphere would be in question. The interpretation in terms of anyonic phases [?] supports this interpretation.
3. The identification of  $J$  as a counterpart of  $eB/\hbar$  means that Kähler action and thus also Kähler function is proportional to  $1/\alpha_K$  and therefore to  $\hbar$ . This implies that for large values of  $\hbar$  Kähler coupling strength  $g_K^2/4\pi$  becomes very small and large fluctuations are suppressed in the functional integral. The basic motivation for introducing the hierarchy of Planck constants was indeed that the scaling  $\alpha \rightarrow \alpha/r$  allows to achieve the convergence of perturbation theory: Nature itself would solve the problems of the theoretician. This of course does not mean that the physical states would remain as such and the replacement of single particles with anyonic states in order to satisfy the condition for  $K$  would realize this concretely.

4. The condition  $K = g_K^2/\hbar$  implies that the Kähler magnetic charge is always accompanied by Kähler electric charge. A more general condition would read as

$$K = n \times \frac{g_K^2}{\hbar}, n \in Z . \quad (2.6.8)$$

This would apply in the case of cosmic strings and would allow vanishing Kähler charge possible when the partonic 2-surface has opposite fermion and antifermion numbers (for both leptons and quarks) so that Kähler electric charge should vanish. For instance, for neutrinos the vanishing of electric charge strongly suggests  $n = 0$  besides the condition that abelian  $Z^0$  flux contributing to em charge vanishes.

It took a year to realize that this value of  $K$  is natural at the Minkowskian side of the wormhole throat. At the Euclidian side much more natural condition is

$$K = \frac{1}{\hbar} . \quad (2.6.9)$$

In fact, the self-duality of  $CP_2$  Kähler form favours this boundary condition at the Euclidian side of the wormhole throat. Also the fact that one cannot distinguish between electric and magnetic charges in Euclidian region since all charges are magnetic can be used to argue in favor of this form. The same constraint arises from the condition that the action for  $CP_2$  type vacuum extremal has the value required by the argument leading to a prediction for gravitational constant in terms of the square of  $CP_2$  radius and  $\alpha_K$  the effective replacement  $g_K^2 \rightarrow 1$  would spoil the argument.

The boundary condition  $J_E = J_B$  for the electric and magnetic parts of Kähler form at the Euclidian side of the wormhole throat inspires the question whether all Euclidian regions could be self-dual so that the density of Kähler action would be just the instanton density. Self-duality follows if the deformation of the metric induced by the deformation of the canonically imbedded  $CP_2$  is such that in  $CP_2$  coordinates for the Euclidian region the tensor  $(g^{\alpha\beta}g^{\mu\nu} - g^{\alpha\nu}g^{\mu\beta})/\sqrt{g}$  remains invariant. This is certainly the case for  $CP_2$  type vacuum extremals since by the light-likeness of  $M^4$  projection the metric remains invariant. Also conformal scalings of the induced metric would satisfy this condition. Conformal scaling is not consistent with the degeneracy of the 4-metric at the wormhole

### Reduction of the quantization of Kähler electric charge to that of electromagnetic charge

The best manner to learn more is to challenge the form of the weak electric-magnetic duality based on the induced Kähler form.

1. Physically it would seem more sensible to pose the duality on electromagnetic charge rather than Kähler charge. This would replace induced Kähler form with electromagnetic field, which is a linear combination of induced Kähler field and classical  $Z^0$  field

$$\begin{aligned} \gamma &= 3J - \sin^2\theta_W R_{03} , \\ Z^0 &= 2R_{03} . \end{aligned} \quad (2.6.10)$$

Here  $Z_0 = 2R_{03}$  is the appropriate component of  $CP_2$  curvature form [?]. For a vanishing Weinberg angle the condition reduces to that for Kähler form.

2. For the Euclidian space-time regions having interpretation as lines of generalized Feynman diagrams Weinberg angle should be non-vanishing. In Minkowskian regions Weinberg angle could however vanish. If so, the condition guaranteeing that electromagnetic charge of the partonic 2-surfaces equals to the above condition stating that the em charge assignable to the fermion content of the partonic 2-surfaces reduces to the classical Kähler electric flux at the Minkowskian side of the wormhole throat. One can argue that Weinberg angle must increase smoothly from a vanishing value at both sides of wormhole throat to its value in the deep interior of the Euclidian region.

3. The vanishing of the Weinberg angle in Minkowskian regions conforms with the physical intuition. Above elementary particle length scales one sees only the classical electric field reducing to the induced Kähler form and classical  $Z^0$  fields and color gauge fields are effectively absent. Only in phases with a large value of Planck constant classical  $Z^0$  field and other classical weak fields and color gauge field could make themselves visible. Cell membrane could be one such system [K55]. This conforms with the general picture about color confinement and weak massivation.

The GRT limit of TGD suggests a further reason for why Weinberg angle should vanish in Minkowskian regions.

1. The value of the Kähler coupling strength must be very near to the value of the fine structure constant in electron length scale and these constants can be assumed to be equal.
2. GRT limit of TGD with space-time surfaces replaced with abstract 4-geometries would naturally correspond to Einstein-Maxwell theory with cosmological constant which is non-vanishing only in Euclidian regions of space-time so that both Reissner-Nordström metric and  $CP_2$  are allowed as simplest possible solutions of field equations [K77]. The extremely small value of the observed cosmological constant needed in GRT type cosmology could be equal to the large cosmological constant associated with  $CP_2$  metric multiplied with the 3-volume fraction of Euclidian regions.
3. Also at GRT limit quantum theory would reduce to almost topological QFT since Einstein-Maxwell action reduces to 3-D term by field equations implying the vanishing of the Maxwell current and of the curvature scalar in Minkowskian regions and curvature scalar + cosmological constant term in Euclidian regions. The weak form of electric-magnetic duality would guarantee also now the preferred extremal property and prevent the reduction to a mere topological QFT.
4. GRT limit would make sense only for a vanishing Weinberg angle in Minkowskian regions. A non-vanishing Weinberg angle would make sense in the deep interior of the Euclidian regions where the approximation as a small deformation of  $CP_2$  makes sense.

The weak form of electric-magnetic duality has surprisingly strong implications for the basic view about quantum TGD as following considerations show.

### 2.6.2 Magnetic confinement, the short range of weak forces, and color confinement

The weak form of electric-magnetic duality has surprisingly strong implications if one combines it with some very general empirical facts such as the non-existence of magnetic monopole fields in macroscopic length scales.

#### How can one avoid macroscopic magnetic monopole fields?

Monopole fields are experimentally absent in length scales above order weak boson length scale and one should have a mechanism neutralizing the monopole charge. How electroweak interactions become short ranged in TGD framework is still a poorly understood problem. What suggests itself is the neutralization of the weak isospin above the intermediate gauge boson Compton length by neutral Higgs bosons. Could the two neutralization mechanisms be combined to single one?

1. In the case of fermions and their super partners the opposite magnetic monopole would be a wormhole throat. If the magnetically charged wormhole contact is electromagnetically neutral but has vectorial weak isospin neutralizing the weak vectorial isospin of the fermion only the electromagnetic charge of the fermion is visible on longer length scales. The distance of this wormhole throat from the fermionic one should be of the order weak boson Compton length. An interpretation as a bound state of fermion and a wormhole throat state with the quantum numbers of a neutral Higgs boson would therefore make sense. The neutralizing throat would have quantum numbers of  $X_{-1/2} = \nu_L \bar{\nu}_R$  or  $X_{1/2} = \bar{\nu}_L \nu_R$ .  $\nu_L \bar{\nu}_R$  would not be neutral Higgs boson (which should correspond to a wormhole contact) but a super-partner of left-handed neutrino obtained by adding a right handed neutrino. This mechanism would apply separately

to the fermionic and anti-fermionic throats of the gauge bosons and corresponding space-time sheets and leave only electromagnetic interaction as a long ranged interaction.

2. One can of course wonder what is the situation for the bosonic wormhole throats feeding gauge fluxes between space-time sheets. It would seem that these wormhole throats must always appear as pairs such that for the second member of the pair monopole charges and  $I_V^3$  cancel each other at both space-time sheets involved so that one obtains at both space-time sheets magnetic dipoles of size of weak boson Compton length. The proposed magnetic character of fundamental particles should become visible at TeV energies so that LHC might have surprises in store!

### Magnetic confinement and color confinement

Magnetic confinement generalizes also to the case of color interactions. One can consider also the situation in which the magnetic charges of quarks (more generally, of color excited leptons and quarks) do not vanish and they form color and magnetic singlets in the hadronic length scale. This would mean that magnetic charges of the state  $q_{\pm 1/2} - X_{\mp 1/2}$  representing the physical quark would not vanish and magnetic confinement would accompany also color confinement. This would explain why free quarks are not observed. To how degree then quark confinement corresponds to magnetic confinement is an interesting question.

For quark and antiquark of meson the magnetic charges of quark and antiquark would be opposite and meson would correspond to a Kähler magnetic flux so that a stringy view about meson emerges. For valence quarks of baryon the vanishing of the net magnetic charge takes place provided that the magnetic net charges are  $(\pm 2, \mp 1, \mp 1)$ . This brings in mind the spectrum of color hyper charges coming as  $(\pm 2, \mp 1, \mp 1)/3$  and one can indeed ask whether color hyper-charge correlates with the Kähler magnetic charge. The geometric picture would be three strings connected to single vertex. Amusingly, the idea that color hypercharge could be proportional to color hyper charge popped up during the first year of TGD when I had not yet discovered  $CP_2$  and believed on  $M^4 \times S^2$ .

p-Adic length scale hypothesis and hierarchy of Planck constants defining a hierarchy of dark variants of particles suggest the existence of scaled up copies of QCD type physics and weak physics. For p-adically scaled up variants the mass scales would be scaled by a power of  $\sqrt{2}$  in the most general case. The dark variants of the particle would have the same mass as the original one. In particular, Mersenne primes  $M_k = 2^k - 1$  and Gaussian Mersennes  $M_{G,k} = (1 + i)^k - 1$  has been proposed to define zoomed copies of these physics. At the level of magnetic confinement this would mean hierarchy of length scales for the magnetic confinement.

One particular proposal is that the Mersenne prime  $M_{89}$  should define a scaled up variant of the ordinary hadron physics with mass scaled up roughly by a factor  $2^{(107-89)/2} = 512$ . The size scale of color confinement for this physics would be same as the weak length scale. It would look more natural that the weak confinement for the quarks of  $M_{89}$  physics takes place in some shorter scale and  $M_{61}$  is the first Mersenne prime to be considered. The mass scale of  $M_{61}$  weak bosons would be by a factor  $2^{(89-61)/2} = 2^{14}$  higher and about  $1.6 \times 10^4$  TeV.  $M_{89}$  quarks would have virtually no weak interactions but would possess color interactions with weak confinement length scale reflecting themselves as new kind of jets at collisions above TeV energies.

In the biologically especially important length scale range 10 nm -2500 nm there are as many as four Gaussian Mersennes corresponding to  $M_{G,k}$ ,  $k = 151, 157, 163, 167$ . This would suggest that the existence of scaled up scales of magnetic-, weak- and color confinement. An especially interesting possibly testable prediction is the existence of magnetic monopole pairs with the size scale in this range. There are recent claims about experimental evidence for magnetic monopole pairs [?].

### Magnetic confinement and stringy picture in TGD sense

The connection between magnetic confinement and weak confinement is rather natural if one recalls that electric-magnetic duality in super-symmetric quantum field theories means that the descriptions in terms of particles and monopoles are in some sense dual descriptions. Fermions would be replaced by string like objects defined by the magnetic flux tubes and bosons as pairs of wormhole contacts would correspond to pairs of the flux tubes. Therefore the sharp distinction between gravitons and physical particles would disappear.



The reason why gravitons are necessarily stringy objects formed by a pair of wormhole contacts is that one cannot construct spin two objects using only single fermion states at wormhole throats. Of course, also super partners of these states with higher spin obtained by adding fermions and anti-fermions at the wormhole throat but these do not give rise to graviton like states [?]. The upper and lower wormhole throat pairs would be quantum superpositions of fermion anti-fermion pairs with sum over all fermions. The reason is that otherwise one cannot realize graviton emission in terms of joining of the ends of light-like 3-surfaces together. Also now magnetic monopole charges are necessary but now there is no need to assign the entities  $X_{\pm}$  with gravitons.

Graviton string is characterized by some p-adic length scale and one can argue that below this length scale the charges of the fermions become visible. Mersenne hypothesis suggests that some Mersenne prime is in question. One proposal is that gravitonic size scale is given by electronic Mersenne prime  $M_{127}$ . It is however difficult to test whether graviton has a structure visible below this length scale.

What happens to the generalized Feynman diagrams is an interesting question. It is not at all clear how closely they relate to ordinary Feynman diagrams. All depends on what one is ready to assume about what happens in the vertices. One could of course hope that zero energy ontology could allow some very simple description allowing perhaps to get rid of the problematic aspects of Feynman diagrams.

1. Consider first the recent view about generalized Feynman diagrams which relies zero energy ontology. A highly attractive assumption is that the particles appearing at wormhole throats are on mass shell particles. For incoming and outgoing elementary bosons and their super partners they would be positive it resp. negative energy states with parallel on mass shell momenta. For virtual bosons they the wormhole throats would have opposite sign of energy and the sum of on mass shell states would give virtual net momenta. This would make possible twistor description of virtual particles allowing only massless particles (in 4-D sense usually and in 8-D sense in TGD framework). The notion of virtual fermion makes sense only if one assumes in the interaction region a topological condensation creating another wormhole throat having no fermionic quantum numbers.
2. The addition of the particles  $X^{\pm}$  replaces generalized Feynman diagrams with the analogs of stringy diagrams with lines replaced by pairs of lines corresponding to fermion and  $X_{\pm 1/2}$ . The members of these pairs would correspond to 3-D light-like surfaces glued together at the vertices of generalized Feynman diagrams. The analog of 3-vertex would not be splitting of the string to form shorter strings but the replication of the entire string to form two strings with same length or fusion of two strings to single string along all their points rather than along ends to form a longer string. It is not clear whether the duality symmetry of stringy diagrams can hold true for the TGD variants of stringy diagrams.
3. How should one describe the bound state formed by the fermion and  $X^{\pm}$ ? Should one describe the state as superposition of non-parallel on mass shell states so that the composite state would be automatically massive? The description as superposition of on mass shell states does not conform with the idea that bound state formation requires binding energy. In TGD framework the notion of negentropic entanglement has been suggested to make possible the analogs of bound states consisting of on mass shell states so that the binding energy is zero [K42]. If this kind of states are in question the description of virtual states in terms of on mass shell states is not lost. Of course, one cannot exclude the possibility that there is infinite number of this kind of states serving as analogs for the excitations of string like object.
4. What happens to the states formed by fermions and  $X_{\pm 1/2}$  in the internal lines of the Feynman diagram? Twistor philosophy suggests that only the higher on mass shell excitations are possible. If this picture is correct, the situation would not change in an essential manner from the earlier one.

The highly non-trivial prediction of the magnetic confinement is that elementary particles should have stringy character in electro-weak length scales and could behaving to become manifest at LHC energies. This adds one further item to the list of non-trivial predictions of TGD about physics at LHC energies [K43].

### 2.6.3 Could Quantum TGD reduce to almost topological QFT?

There seems to be a profound connection with the earlier unrealistic proposal that TGD reduces to almost topological quantum theory in the sense that the counterpart of Chern-Simons action assigned with the wormhole throats somehow dictates the dynamics. This proposal can be formulated also for the modified Dirac action action. I gave up this proposal but the following argument shows that Kähler action with weak form of electric-magnetic duality effectively reduces to Chern-Simons action plus Coulomb term.

1. Kähler action density can be written as a 4-dimensional integral of the Coulomb term  $j_K^\alpha A_\alpha$  plus and integral of the boundary term  $J^{n\beta} A_\beta \sqrt{g_4}$  over the wormhole throats and of the quantity  $J^{0\beta} A_\beta \sqrt{g_4}$  over the ends of the 3-surface.
2. If the self-duality conditions generalize to  $J^{n\beta} = 4\pi\alpha_K \epsilon^{n\beta\gamma\delta} J_{\gamma\delta}$  at throats and to  $J^{0\beta} = 4\pi\alpha_K \epsilon^{0\beta\gamma\delta} J_{\gamma\delta}$  at the ends, the Kähler function reduces to the counterpart of Chern-Simons action evaluated at the ends and throats. It would have same value for each branch and the replacement  $\hbar_0 \rightarrow r\hbar_0$  would effectively describe this. Boundary conditions would however give  $1/r$  factor so that  $\hbar$  would disappear from the Kähler function! The original attempt to realize quantum TGD as an almost topological QFT was in terms of Chern-Simons action but was given up. It is somewhat surprising that Kähler action gives Chern-Simons action in the vacuum sector defined as sector for which Kähler current is light-like or vanishes.

Holography encourages to ask whether also the Coulomb interaction terms could vanish. This kind of dimensional reduction would mean an enormous simplification since TGD would reduce to an almost topological QFT. The attribute "almost" would come from the fact that one has non-vanishing classical Noether charges defined by Kähler action and non-trivial quantum dynamics in  $M^4$  degrees of freedom. One could also assign to space-time surfaces conserved four-momenta which is not possible in topological QFTs. For this reason the conditions guaranteeing the vanishing of Coulomb interaction term deserve a detailed analysis.

1. For the known extremals  $j_K^\alpha$  either vanishes or is light-like ("massless extremals" for which weak self-duality condition does not make sense [K9] ) so that the Coulombic term vanishes identically in the gauge used. The addition of a gradient to  $A$  induces terms located at the ends and wormhole throats of the space-time surface but this term must be cancelled by the other boundary terms by gauge invariance of Kähler action. This implies that the  $M^4$  part of WCW metric vanishes in this case. Therefore massless extremals as such are not physically realistic: wormhole throats representing particles are needed.
2. The original naive conclusion was that since Chern-Simons action depends on  $CP_2$  coordinates only, its variation with respect to Minkowski coordinates must vanish so that the WCW metric would be trivial in  $M^4$  degrees of freedom. This conclusion is in conflict with quantum classical correspondence and was indeed too hasty. The point is that the allowed variations of Kähler function must respect the weak electro-magnetic duality which relates Kähler electric field depending on the induced 4-metric at 3-surface to the Kähler magnetic field. Therefore the dependence on  $M^4$  coordinates creeps via a Lagrange multiplier term

$$\int \Lambda_\alpha (J^{n\alpha} - K \epsilon^{n\alpha\beta\gamma} J_{\beta\gamma}) \sqrt{g_4} d^3x . \quad (2.6.11)$$

The (1,1) part of second variation contributing to  $M^4$  metric comes from this term.

3. This erratic conclusion about the vanishing of  $M^4$  part WCW metric raised the question about how to achieve a non-trivial metric in  $M^4$  degrees of freedom. The proposal was a modification of the weak form of electric-magnetic duality. Besides  $CP_2$  Kähler form there would be the Kähler form assignable to the light-cone boundary reducing to that for  $r_M = \text{constant}$  sphere - call it  $J^1$ . The generalization of the weak form of self-duality would be  $J^{n\beta} = \epsilon^{n\beta\gamma\delta} K (J_{\gamma\delta} + \epsilon J_{\gamma\delta}^1)$ . This form implies that the boundary term gives a non-trivial contribution to the  $M^4$  part of

the WCW metric even without the constraint from electric-magnetic duality. Kähler charge is not affected unless the partonic 2-surface contains the tip of  $CD$  in its interior. In this case the value of Kähler charge is shifted by a topological contribution. Whether this term can survive depends on whether the resulting vacuum extremals are consistent with the basic facts about classical gravitation.

4. The Coulombic interaction term is not invariant under gauge transformations. The good news is that this might allow to find a gauge in which the Coulomb term vanishes. The vanishing condition fixing the gauge transformation  $\phi$  is

$$j_K^\alpha \partial_\alpha \phi = -j^\alpha A_\alpha \quad . \quad (2.6.12)$$

This differential equation can be reduced to an ordinary differential equation along the flow lines  $j_K$  by using  $dx^\alpha/dt = j_K^\alpha$ . Global solution is obtained only if one can combine the flow parameter  $t$  with three other coordinates- say those at the either end of  $CD$  to form space-time coordinates. The condition is that the parameter defining the coordinate differential is proportional to the covariant form of Kähler current:  $dt = \phi j_K$ . This condition in turn implies  $d^2t = d(\phi j_K) = d\phi \wedge j_K + \phi dj_K = 0$  implying  $j_K \wedge dj_K = 0$  or more concretely,

$$\epsilon^{\alpha\beta\gamma\delta} j_\beta^K \partial_\gamma j_\delta^K = 0 \quad . \quad (2.6.13)$$

$j_K$  is a four-dimensional counterpart of Beltrami field [?] and could be called generalized Beltrami field.

The integrability conditions follow also from the construction of the extremals of Kähler action [K9]. The conjecture was that for the extremals the 4-dimensional Lorentz force vanishes (no dissipation): this requires  $j_K \wedge J = 0$ . One manner to guarantee this is the topologization of the Kähler current meaning that it is proportional to the instanton current:  $j_K = \phi j_I$ , where  $j_I = *(J \wedge A)$  is the instanton current, which is not conserved for 4-D  $CP_2$  projection. The conservation of  $j_K$  implies the condition  $j_I^\alpha \partial_\alpha \phi = \partial_\alpha j^\alpha \phi$  and from this  $\phi$  can be integrated if the integrability condition  $j_I \wedge dj_I = 0$  holds true implying the same condition for  $j_K$ . By introducing at least 3 or  $CP_2$  coordinates as space-time coordinates, one finds that the contravariant form of  $j_I$  is purely topological so that the integrability condition fixes the dependence on  $M^4$  coordinates and this selection is coded into the scalar function  $\phi$ . These functions define families of conserved currents  $j_K^\alpha \phi$  and  $j_I^\alpha \phi$  and could be also interpreted as conserved currents associated with the critical deformations of the space-time surface.

5. There are gauge transformations respecting the vanishing of the Coulomb term. The vanishing condition for the Coulomb term is gauge invariant only under the gauge transformations  $A \rightarrow A + \nabla\phi$  for which the scalar function the integral  $\int j_K^\alpha \partial_\alpha \phi$  reduces to a total divergence a giving an integral over various 3-surfaces at the ends of  $CD$  and at throats vanishes. This is satisfied if the allowed gauge transformations define conserved currents

$$D_\alpha(j^\alpha \phi) = 0 \quad . \quad (2.6.14)$$

As a consequence Coulomb term reduces to a difference of the conserved charges  $Q_\phi^e = \int j^0 \phi \sqrt{g_4} d^3x$  at the ends of the CD vanishing identically. The change of the imons type term is trivial if the total weighted Kähler magnetic flux  $Q_\phi^m = \sum \int J \phi dA$  over wormhole throats is conserved. The existence of an infinite number of conserved weighted magnetic fluxes is in accordance with the electric-magnetic duality. How these fluxes relate to the flux Hamiltonians central for WCW geometry is not quite clear.

6. The gauge transformations respecting the reduction to almost topological QFT should have some special physical meaning. The measurement interaction term in the modified Dirac interaction corresponds to a critical deformation of the space-time sheet and is realized as an addition of a gauge part to the Kähler gauge potential of  $CP_2$ . It would be natural to identify this gauge transformation giving rise to a conserved charge so that the conserved charges would provide a representation for the charges associated with the infinitesimal critical deformations not affecting Kähler action. The gauge transformed Kähler potential couples to the modified Dirac equation and its effect could be visible in the value of Kähler function and therefore also in the properties of the preferred extremal. The effect on WCW metric would however vanish since  $K$  would transform only by an addition of a real part of a holomorphic function. Kähler function is identified as a Dirac determinant for Chern-Simons Dirac action and the spectrum of this operator should not be invariant under these gauge transformations if this picture is correct. This is achieved if the gauge transformation is carried only in the Dirac action corresponding to the Chern-Simons term: this assumption is motivated by the breaking of time reversal invariance induced by quantum measurements. The modification of Kähler action can be guessed to correspond just to the Chern-Simons contribution from the instanton term.
7. A reasonable looking guess for the explicit realization of the quantum classical correspondence between quantum numbers and space-time geometry is that the deformation of the preferred extremal due to the addition of the measurement interaction term is induced by a  $U(1)$  gauge transformation induced by a transformation of  $\delta CD \times CP_2$  generating the gauge transformation represented by  $\phi$ . This interpretation makes sense if the fluxes defined by  $Q_\phi^m$  and corresponding Hamiltonians affect only zero modes rather than quantum fluctuating degrees of freedom.

To sum up, one could understand the basic properties of WCW metric in this framework. Effective 2-dimensionality would result from the existence of an infinite number of conserved charges in two different time directions (genuine conservation laws plus gauge fixing). The infinite-dimensional symmetric space for given values of zero modes corresponds to the Cartesian product of the WCWs associated with the partonic 2-surfaces at both ends of  $CD$  and the generalized Chern-Simons term decomposes into a sum of terms from the ends giving single particle Kähler functions and to the terms from light-like wormhole throats giving interaction term between positive and negative energy parts of the state. Hence Kähler function could be calculated without any knowledge about the interior of the space-time sheets and TGD would reduce to almost topological QFT as speculated earlier. Needless to say this would have immense boost to the program of constructing WCW Kähler geometry.

#### 2.6.4 Kähler action for Euclidian regions as Kähler function and Kähler action for Minkowskian regions as Morse function?

One of the nasty questions about the interpretation of Kähler action relates to the square root of the metric determinant. If one proceeds completely straightforwardly, the only reason conclusion is that the square root is imaginary in Minkowskian space-time regions so that Kähler action would be complex. The Euclidian contribution would have a natural interpretation as positive definite Kähler function but how should one interpret the imaginary Minkowskian contribution? Certainly the path integral approach to quantum field theories supports its presence. For some mysterious reason I was able to forget this nasty question and serious consideration of the obvious answer to it. Only when I worked between possible connections between TGD and Floer homology [?] I realized that the Minkowskian contribution is an excellent candidate for Morse function whose critical points give information about WCW homology. This would fit nicely with the vision about TGD as almost topological QFT.

Euclidian regions would guarantee the convergence of the functional integral and one would have a mathematically well-defined theory. Minkowskian contribution would give the quantal interference effects and stationary phase approximation. The analog of Floer homology would represent quantum superpositions of critical points identifiable as ground states defined by the extrema of Kähler action for Minkowskian regions. Perturbative approach to quantum TGD would rely on functional integrals around the extrema of Kähler function. One would have maxima also for the Kähler function but only in the zero modes not contributing to the WCW metric.

There is a further question related to almost topological QFT character of TGD. Should one assume that the reduction to Chern-Simons terms occurs for the preferred extremals in *both* Minkowskian and Euclidian regions or only in Minkowskian regions?

1. All arguments for this have been represented for Minkowskian regions [?] involve local light-like momentum direction which does not make sense in the Euclidian regions. This does not however kill the argument: one can have non-trivial solutions of Laplacian equation in the region of  $CP_2$  bounded by wormhole throats: for  $CP_2$  itself only covariantly constant right-handed neutrino represents this kind of solution and at the same time supersymmetry. In the general case solutions of Laplacian represent broken super-symmetries and should be in one-one correspondences with the solutions of the modified Dirac equation. The interpretation for the counterparts of momentum and polarization would be in terms of classical representation of color quantum numbers.

If the reduction occurs in Euclidian regions, it gives in the case of  $CP_2$  two 3-D terms corresponding to two 3-D gluing regions for three coordinate patches needed to define coordinates and spinor connection for  $CP_2$  so that one would have two Chern-Simons terms. Without any other contributions the first term would be identical with that from Minkowskian region apart from imaginary unit. Second Chern-Simons term would be however independent of this. For wormhole contacts the two terms could be assigned with opposite wormhole throats and would be identical with their Minkowskian cousins from imaginary unit. This looks a little bit strange.

2. There is however a very delicate issue involved. Quantum classical correspondence requires that the quantum numbers of partonic states must be coded to the space-time geometry, and this is achieved by adding to the action a measurement interaction term which reduces to what is almost a gauge term present only in Chern-Simons-Dirac equation but not at space-time interior [?]. This term would represent a coupling to Poincare quantum numbers at the Minkowskian side and to color and electro-weak quantum numbers at  $CP_2$  side. Therefore the net Chern-Simons contributions and would be different.
3. There is also a very beautiful argument stating that Dirac determinant for Chern-Simons-Dirac action equals to Kähler function, which would be lost if Euclidian regions would not obey holography. The argument obviously generalizes and applies to both Morse and Kähler function.

The Minkowskian contribution of Kähler action is imaginary due to the negative of the metric determinant and gives a phase factor to vacuum functional reducing to Chern-Simons terms at wormhole throats. Ground state degeneracy due to the possibility of having both signs for Minkowskian contribution to the exponent of vacuum functional provides a general view about the description of CP breaking in TGD framework.

1. In TGD framework path integral is replaced by inner product involving integral over WCV. The vacuum functional and its conjugate are associated with the states in the inner product so that the phases of vacuum functionals cancel if only one sign for the phase is allowed. Minkowskian contribution would have no physical significance. This of course cannot be the case. The ground state is actually degenerate corresponding to the phase factor and its complex conjugate since  $\sqrt{g}$  can have two signs in Minkowskian regions. Therefore the inner products between states associated with the two ground states define  $2 \times 2$  matrix and non-diagonal elements contain interference terms due to the presence of the phase factor. At the limit of full  $CP_2$  type vacuum extremal the two ground states would reduce to each other and the determinant of the matrix would vanish.
2. A small mixing of the two ground states would give rise to CP breaking and the first principle description of CP breaking in systems like  $K - \bar{K}$  and of CKM matrix should reduce to this mixing.  $K^0$  mesons would be CP even and odd states in the first approximation and correspond to the sum and difference of the ground states. Small mixing would be present having exponential sensitivity to the actions of  $CP_2$  type extremals representing wormhole throats. This might allow to understand qualitatively why the mixing is about 50 times larger than expected for  $B^0$  mesons.
3. There is a strong temptation to assign the two ground states with two possible arrows of geometric time. At the level of M-matrix the two arrows would correspond to state preparation at

either upper or lower boundary of CD. Do long- and shortlived neutral K mesons correspond to almost fifty-fifty orthogonal superpositions for the two arrow of geometric time or almost completely to a fixed arrow of time induced by environment? Is the dominant part of the arrow same for both or is it opposite for long and short-lived neutral mesons? Different lifetimes would suggest that the arrow must be the same and apart from small leakage that induced by environment. CP breaking would be induced by the fact that CP is performed only  $K^0$  but not for the environment in the construction of states. One can probably imagine also alternative interpretations.

*Remark:* The proportionality of Minkowskian and Euclidian contributions to the same Chern-Simons term implies that the critical points with respect to zero modes appear for both the phase and modulus of vacuum functional. The Kähler function property does not allow extrema for vacuum functional as a function of complex coordinates of WCW since this would mean Kähler metric with non-Euclidian signature. If this were not the case, the stationary values of phase factor and extrema of modulus of the vacuum functional would correspond to different configurations.

### 2.6.5 A general solution ansatz based on almost topological QFT property

The basic vision behind the ansatz is the reduction of quantum TGD to almost topological field theory. This requires that the flow parameters associated with the flow lines of isometry currents and Kähler current extend to global coordinates. This leads to integrability conditions implying generalized Beltrami flow and Kähler action for the preferred extremals reduces to Chern-Simons action when weak electro-weak duality is applied as boundary conditions. The strongest form of the hydrodynamical interpretation requires that all conserved currents are parallel to Kähler current. In the more general case one would have several hydrodynamic flows. Also the braidings (several of them for the most general ansatz) assigned with the light-like 3-surfaces are naturally defined by the flow lines of conserved currents. The independent behavior of particles at different flow lines can be seen as a realization of the complete integrability of the theory. In free quantum field theories on mass shell Fourier components are in a similar role but the geometric interpretation in terms of flow is of course lacking. This picture should generalize also to the solution of the modified Dirac equation.

#### Basic field equations

Consider first the equations at general level.

1. The breaking of the Poincare symmetry due to the presence of monopole field occurs and leads to the isometry group  $T \times SO(3) \times SU(3)$  corresponding to time translations, rotations, and color group. The Cartan algebra is four-dimensional and field equations reduce to the conservation laws of energy  $E$ , angular momentum  $J$ , color isospin  $I_3$ , and color hypercharge  $Y$ .
2. Quite generally, one can write the field equations as conservation laws for  $I, J, I_3$ , and  $Y$ .

$$D_\alpha [D_\beta (J^{\alpha\beta} H_A) - j_K^\alpha H^A + T^{\alpha\beta} j_A^l h_{kl} \partial_\beta h^l] = 0 . \quad (2.6.15)$$

The first term gives a contraction of the symmetric Ricci tensor with antisymmetric Kähler form and vanishes so that one has

$$D_\alpha [j_K^\alpha H^A - T^{\alpha\beta} j_A^k h_{kl} \partial_\beta h^l] = 0 . \quad (2.6.16)$$

For energy one has  $H_A = 1$  and energy current associated with the flow lines is proportional to the Kähler current. Its divergence vanishes identically.

3. One can express the divergence of the term involving energy momentum tensor as a sum of terms involving  $j_K^\alpha J_{\alpha\beta}$  and contraction of second fundamental form with energy momentum tensor so that one obtains

$$j_K^\alpha D_\alpha H^A = j_K^\alpha J_{\alpha\beta} j_\beta^A + T^{\alpha\beta} H_{\alpha\beta}^k j_k^A . \quad (2.6.17)$$

### Hydrodynamical solution ansatz

The characteristic feature of the solution ansatz would be the reduction of the dynamics to hydrodynamics analogous to that for a continuous distribution of particles initially at the end of  $X^3$  of the light-like 3-surface moving along flow lines defined by currents  $j_A$  satisfying the integrability condition  $j_A \wedge dj_A = 0$ . Field theory would reduce effectively to particle mechanics along flow lines with conserved charges defined by various isometry currents. The strongest condition is that all isometry currents  $j_A$  and also Kähler current  $j_K$  are proportional to the same current  $j$ . The more general option corresponds to multi-hydrodynamics.

Conserved currents are analogous to hydrodynamical currents in the sense that the flow parameter along flow lines extends to a global space-time coordinate. The conserved current is proportional to the gradient  $\nabla\Phi$  of the coordinate varying along the flow lines:  $J = \Psi\nabla\Phi$  and by a proper choice of  $\Psi$  one can allow to have conservation. The initial values of  $\Psi$  and  $\Phi$  can be selected freely along the flow lines beginning from either the end of the space-time surface or from wormhole throats.

If one requires hydrodynamics also for Chern-Simons action (effective 2-dimensionality is required for preferred extremals), the initial values of scalar functions can be chosen freely only at the partonic 2-surfaces. The freedom to choose the initial values of the charges conserved along flow lines at the partonic 2-surfaces means the existence of an infinite number of conserved charges so that the theory would be integrable and even in two different coordinate directions. The basic difference as compared to ordinary conservation laws is that the conserved currents are parallel and their flow parameter extends to a global coordinate.

1. The most general assumption is that the conserved isometry currents

$$J_A^\alpha = j_K^\alpha H^A - T^{\alpha\beta} j_A^k h_{kl} \partial_\beta h^l \quad (2.6.18)$$

and Kähler current are integrable in the sense that  $J_A \wedge J_A = 0$  and  $j_K \wedge j_K = 0$  hold true. One could imagine the possibility that the currents are not parallel.

2. The integrability condition  $dJ_A \wedge J_A = 0$  is satisfied if one has

$$J_A = \Psi_A d\Phi_A . \quad (2.6.19)$$

The conservation of  $J_A$  gives

$$d * (\Psi_A d\Phi_A) = 0 . \quad (2.6.20)$$

This would mean separate hydrodynamics for each of the currents involved. In principle there is no need to assume any further conditions and one can imagine infinite basis of scalar function pairs  $(\Psi_A, \Phi_A)$  since criticality implies infinite number deformations implying conserved Noether currents.

3. The conservation condition reduces to d'Alembert equation in the induced metric if one assumes that  $\nabla\Psi_A$  is orthogonal with every  $d\Phi_A$ .

$$d * d\Phi_A = 0 , \quad d\Psi_A \cdot d\Phi_A = 0 . \quad (2.6.21)$$

Taking  $x = \Phi_A$  as a coordinate the orthogonality condition states  $g^{xj}\partial_j\Psi_A = 0$  and in the general case one cannot solve the condition by simply assuming that  $\Psi_A$  depends on the coordinates transversal to  $\Phi_A$  only. These conditions bring in mind  $p \cdot p = 0$  and  $p \cdot e$  condition for massless modes of Maxwell field having fixed momentum and polarization.  $d\Phi_A$  would correspond to  $p$  and  $d\Psi_A$  to polarization. The condition that each isometry current corresponds its own pair  $(\Psi_A, \Phi_A)$  would mean that each isometry current corresponds to independent light-like momentum and polarization. Ordinary free quantum field theory would support this view whereas hydrodynamics and QFT limit of TGD would support single flow.

These are the most general hydrodynamical conditions that one can assume. One can consider also more restricted scenarios.

1. The strongest ansatz is inspired by the hydrodynamical picture in which all conserved isometry charges flow along same flow lines so that one would have

$$J_A = \Psi_A d\Phi . \quad (2.6.22)$$

In this case same  $\Phi$  would satisfy simultaneously the d'Alembert type equations.

$$d * d\Phi = 0 , \quad d\Psi_A \cdot d\Phi = 0 . \quad (2.6.23)$$

This would mean that the massless modes associated with isometry currents move in parallel manner but can have different polarizations. The spinor modes associated with light-light like 3-surfaces carry parallel four-momenta, which suggest that this option is correct. This allows a very general family of solutions and one can have a complete 3-dimensional basis of functions  $\Psi_A$  with gradient orthogonal to  $d\Phi$ .

2. Isometry invariance under  $T \times SO(3) \times SU(3)$  allows to consider the possibility that one has

$$J_A = k_A \Psi_A d\Phi_{G(A)} , \quad d * (d\Phi_{G(A)}) = 0 , \quad d\Psi_A \cdot d\Phi_{G(A)} = 0 . \quad (2.6.24)$$

where  $G(A)$  is  $T$  for energy current,  $SO(3)$  for angular momentum currents and  $SU(3)$  for color currents. Energy would thus flow along its own flux lines, angular momentum along its own flow lines, and color quantum numbers along their own flow lines. For instance, color currents would differ from each other only by a numerical constant. The replacement of  $\Psi_A$  with  $\Psi_{G(A)}$  would be too strong a condition since Killing vector fields are not related by a constant factor.

To sum up, the most general option is that each conserved current  $J_A$  defines its own integrable flow lines defined by the scalar function pair  $(\Psi_A, \Phi_A)$ . A complete basis of scalar functions satisfying the d'Alembert type equation guaranteeing current conservation could be imagined with restrictions coming from the effective 2-dimensionality reducing the scalar function basis effectively to the partonic 2-surface. The diametrically opposite option corresponds to the basis obtained by assuming that only single  $\Phi$  is involved.

The proposed solution ansatz can be compared to the earlier ansatz [?] stating that Kähler current is topologized in the sense that for  $D(CP_2) = 3$  it is proportional to the identically conserved



instanton current (so that 4-D Lorentz force vanishes) and vanishes for  $D(CP_2) = 4$  (Maxwell phase). This hypothesis requires that instanton current is Beltrami field for  $D(CP_2) = 3$ . In the recent case the assumption that also instanton current satisfies the Beltrami hypothesis in strong sense (single function  $\Phi$ ) generalizes the topologization hypothesis for  $D(CP_2) = 3$ . As a matter fact, the topologization hypothesis applies to isometry currents also for  $D(CP_2) = 4$  although instanton current is not conserved anymore.

### Can one require the extremal property in the case of Chern-Simons action?

Effective 2-dimensionality is achieved if the ends and wormhole throats are extremals of Chern-Simons action. The strongest condition would be that space-time surfaces allow orthogonal slicings by 3-surfaces which are extremals of Chern-Simons action.

Also in this case one can require that the flow parameter associated with the flow lines of the isometry currents extends to a global coordinate. Kähler magnetic field  $B = *J$  defines a conserved current so that all conserved currents would flow along the field lines of  $B$  and one would have 3-D Beltrami flow. Note that in magnetohydrodynamics the standard assumption is that currents flow along the field lines of the magnetic field.

For wormhole throats light-likeness causes some complications since the induced metric is degenerate and the contravariant metric must be restricted to the complement of the light-like direction. This means that d'Alembert equation reduces to 2-dimensional Laplace equation. For space-like 3-surfaces one obtains the counterpart of Laplace equation with partonic 2-surfaces serving as sources. The interpretation in terms of analogs of Coulomb potentials created by 2-D charge distributions would be natural.

## 2.6.6 Hydrodynamic picture in fermionic sector

Super-symmetry inspires the conjecture that the hydrodynamical picture applies also to the solutions of the modified Dirac equation.

### 4-dimensional modified Dirac equation and hydrodynamical picture

Consider first the solutions of the induced spinor field in the interior of space-time surface.

1. The local inner products of the modes of the induced spinor fields define conserved currents

$$\begin{aligned} D_\alpha J_{mn}^\alpha &= 0 , \\ J_{mn}^\alpha &= \bar{u}_m \hat{\Gamma}^\alpha u_n , \\ \hat{\Gamma}^\alpha &= \frac{\partial L_K}{\partial(\partial_\alpha h^k)} \Gamma_k . \end{aligned} \quad (2.6.25)$$

The conjecture is that the flow parameters of also these currents extend to a global coordinate so that one would have in the completely general case the condition

$$\begin{aligned} J_{mn}^\alpha &= \Phi_{mn} d\Psi_{mn} , \\ d*(d\Phi_{mn}) &= 0 , \quad \nabla \Psi_{mn} \cdot \Phi_{mn} = 0 . \end{aligned} \quad (2.6.26)$$

The condition  $\Phi_{mn} = \Phi$  would mean that the massless modes propagate in parallel manner and along the flow lines of Kähler current. The conservation condition along the flow line implies that the current component  $J_{mn}$  is constant along it. Everything would reduce to initial values at the ends of the space-time sheet boundaries of  $CD$  and 3-D modified Dirac equation would reduce everything to initial values at partonic 2-surfaces.

2. One might hope that the conservation of these super currents for all modes is equivalent with the modified Dirac equation. The modes  $u_n$  appearing in  $\Psi$  in quantized theory would be kind of "square roots" of the basis  $\Phi_{mn}$  and the challenge would be to deduce the modes from the conservation laws.
3. The quantization of the induced spinor field in 4-D sense would be fixed by those at 3-D space-like ends by the fact that the oscillator operators are carried along the flow lines as such so that the anti-commutator of the induced spinor field at the opposite ends of the flow lines at the light-like boundaries of  $CD$  is in principle fixed by the anti-commutations at the either end. The anti-commutations at 3-D surfaces cannot be fixed freely since one has 3-D Chern-Simons flow reducing the anti-commutations to those at partonic 2-surfaces.

The following argument suggests that induced spinor fields are in a suitable gauge simply constant along the flow lines of the Kähler current just as massless spinor modes are constant along the geodesic in the direction of momentum.

1. The modified gamma matrices are of form  $T_k^\alpha \Gamma^k$ ,  $T_k^\alpha = \partial L_K / \partial (\partial_\alpha h^k)$ . The H-vectors  $T_k^\alpha$  can be expressed as linear combinations of a subset of Killing vector fields  $j_A^k$  spanning the tangent space of  $H$ . For  $CP_2$  the natural choice are the 4 Lie-algebra generators in the complement of  $U(2)$  sub-algebra. For  $CD$  one can use generator time translation and three generators of rotation group  $SO(3)$ . The completeness of the basis defined by the subset of Killing vector fields gives completeness relation  $h_l^k = j^{Ak} j_{Ak}$ . This implies  $T^{\alpha k} = T^{\alpha k} j_A^k j_A^k = T^{\alpha A} j_A^k$ . One can define gamma matrices  $\Gamma_A$  as  $\Gamma_k j_A^k$  to get  $T_k^\alpha \Gamma^k = T^{\alpha A} \Gamma_A$ .
2. This together with the condition that all isometry currents are proportional to the Kähler current (or if this vanishes to some conserved current- say energy current) satisfying Beltrami flow property implies that one can reduce the modified Dirac equation to an ordinary differential equation along flow lines. The quantities  $T^{tA}$  are constant along the flow lines and one obtains

$$T^{tA} j_A D_t \Psi = 0 . \quad (2.6.27)$$

By choosing the gauge suitably the spinors are just constant along flow lines so that the spinor basis reduces by effective 2-dimensionality to a complete spinor basis at partonic 2-surfaces.

### Generalized eigen modes for the modified Chern-Simons Dirac equation and hydrodynamical picture

Hydrodynamical picture helps to understand also the construction of generalized eigen modes of 3-D Chern-Simons Dirac equation.

*The general form of generalized eigenvalue equation for Chern-Simons Dirac action*

Consider first the the general form and interpretation of the generalized eigenvalue equation assigned with the modified Dirac equation for Chern-Simons action [K15] . This is of course only an approximation since an additional contribution to the modified gamma matrices from the Lagrangian multiplier term guaranteeing the weak form of electric-magnetic duality must be included.

1. The modified Dirac equation for  $\Psi$  is consistent with that for its conjugate if the coefficient of the instanton term is real and one uses the Dirac action  $\bar{\Psi}(D^\rightarrow - D^\leftarrow)\Psi$  giving modified Dirac equation as

$$D_{C-S} \Psi + \frac{1}{2} (D_\alpha \hat{\Gamma}_{C-S}^\alpha) \Psi = 0 . \quad (2.6.28)$$

As noticed, the divergence  $D_\alpha \hat{\Gamma}_{C-S}^\alpha$  does not contain second derivatives in the case of Chern-Simons action. In the case of Kähler action they occur unless field equations equivalent with the

vanishing of the divergence term are satisfied. The extremals of Chern-Simons action provide a natural manner to define effective 2-dimensionality.

Also the fermionic current is conserved in this case, which conforms with the idea that fermions flow along the light-like 3-surfaces. If one uses the action  $\bar{\Psi}D^{\rightarrow}\Psi$ ,  $\bar{\Psi}$  does not satisfy the Dirac equation following from the variational principle and fermion current is not conserved.

2. The generalized eigen modes of  $D_{C-S}$  should be such that one obtains the counterpart of Dirac propagator which is purely algebraic and does not therefore depend on the coordinates of the throat. This is satisfied if the generalized eigenvalues are expressible in terms of covariantly constant combinations of gamma matrices and here only  $M^4$  gamma matrices are possible. Therefore the eigenvalue equation would read as

$$D\Psi = \lambda^k \gamma_k \Psi, \quad D = D_{C-S} + \frac{1}{2} D_{\alpha} \hat{\Gamma}_{C-S}^{\alpha}, \quad D_{C-S} = \hat{\Gamma}_{C-S}^{\alpha} D_{\alpha}. \quad (2.6.29)$$

Here the covariant derivatives  $D_{\alpha}$  contain the measurement interaction term as an apparent gauge term. For extremals one has

$$D = D_{C-S}. \quad (2.6.30)$$

Covariant constancy allows to take the square of this equation and one has

$$(D^2 + [D, \lambda^k \gamma_k])\Psi = \lambda^k \lambda_k \Psi. \quad (2.6.31)$$

The commutator term is analogous to magnetic moment interaction.

3. The generalized eigenvalues correspond to  $\lambda = \sqrt{\lambda^k \lambda_k}$  and Dirac determinant is defined as a product of the eigenvalues and conjecture to give the exponent of Kähler action reducing to Chern-Simons term.  $\lambda$  is completely analogous to mass.  $\lambda_k$  cannot be however interpreted as ordinary four-momentum: for instance, number theoretic arguments suggest that  $\lambda_k$  must be restricted to the preferred plane  $M^2 \subset M^4$  interpreted as a commuting hyper-complex plane of complexified quaternions. For incoming lines this mass would vanish so that all incoming particles irrespective their actual quantum numbers would be massless in this sense and the propagator is indeed that for a massless particle. Note that the eigen-modes define the boundary values for the solutions of  $D_K \Psi = 0$  so that the values of  $\lambda$  indeed define the counterpart of the momentum space.

This transmutation of massive particles to effectively massless ones might make possible the application of the twistor formalism as such in TGD framework [?].  $N = 4$  SUSY is one of the very few gauge theory which might be UV finite but it is definitely unphysical due to the masslessness of the basic quanta. Could the resolution of the interpretational problems be that the four-momenta appearing in this theory do not directly correspond to the observed four-momenta?

### 2. Inclusion of the constraint term

As already noticed one must include also the constraint term due to the weak form of electric-magnetic duality and this changes somewhat the above simple picture.

1. At the 3-dimensional ends of the space-time sheet and at wormhole throats the 3-dimensionality allows to introduce a coordinate varying along the flow lines of Kähler magnetic field  $B = *J$ . In this case the integrability conditions state that the flow is Beltrami flow. Note that the value of  $B^\alpha$  along the flow line defining magnetic flux appearing in anti-commutation relations is constant. This suggests that the generalized eigenvalue equation for the Chern-Simons action reduces to a collection of ordinary apparently independent differential equations associated with the flow lines beginning from the partonic 2-surface. This indeed happens when the  $CP_2$  projection is 2-dimensional. In this case it however seems that the basis  $u_n$  is not of much help.
2. The conclusion is wrong: the variations of Chern-Simons action are subject to the constraint that electric-magnetic duality holds true expressible in terms of Lagrange multiplier term

$$\int \Lambda_\alpha (J^{n\alpha} - K \epsilon^{n\alpha\beta\gamma} J_{\beta\gamma}) \sqrt{g_4} d^3 x . \quad (2.6.32)$$

This gives a constraint force to the field equations and also a dependence on the induced 4-metric so that one has only almost topological QFT. This term also guarantees the  $M^4$  part of WCW Kähler metric is non-trivial. The condition that the ends of space-time sheet and wormhole throats are extrema of Chern-Simons action subject to the electric-magnetic duality constraint is strongly suggested by the effective 2-dimensionality. Without the constraint term Chern-Simons action would vanish for its extremals so that Kähler function would be identically zero.

This term implies also an additional contribution to the modified gamma matrices besides the contribution coming from Chern-Simons action so that the first guess for the modified Dirac operator would not be quite correct. This contribution is of exactly of the same general form as the contribution for any general general coordinate invariant action. The dependence of the induced metric on  $M^4$  degrees of freedom guarantees that also  $M^4$  gamma matrices are present. In the following this term will not be considered.

3. When the contribution of the constraint term to the modified gamma matrices is neglected, the explicit expression of the modified Dirac operator  $D_{C-S}$  associated with the Chern-Simons term is given by

$$\begin{aligned} D &= \hat{\Gamma}^\mu D_\mu + \frac{1}{2} D_\mu \hat{\Gamma}^\mu , \\ \hat{\Gamma}^\mu &= \frac{\partial L_{C-S}}{\partial_\mu h^k} \Gamma_k = \epsilon^{\mu\alpha\beta} [2J_{kl} \partial_\alpha h^l A_\beta + J_{\alpha\beta} A_k] \Gamma^k D_\mu , \\ D_\mu \hat{\Gamma}^\mu &= B_K^\alpha (J_{k\alpha} + \partial_\alpha A_k) , \\ B_K^\alpha &= \epsilon^{\alpha\beta\gamma} J_{\beta\gamma} , \quad J_{k\alpha} = J_{kl} \partial_\alpha s^l , \quad \hat{\epsilon}^{\alpha\beta\gamma} = \epsilon^{\alpha\beta\gamma} \sqrt{g_3} . \end{aligned} \quad (2.6.33)$$

For the extremals of Chern-Simons action one has  $D_\alpha \hat{\Gamma}^\alpha = 0$ . Analogous condition holds true when the constraining contribution to the modified gamma matrices is added.

### 3. Generalized eigenvalue equation for Chern-Simons Dirac action

Consider now the Chern-Simons Dirac equation in more detail assuming that the inclusion of the constraint contribution to the modified gamma matrices does not induce any complications. Assume also extremal property for Chern-Simons action with constraint term and Beltrami flow property.

1. For the extremals the Chern-Simons Dirac operator (constraint term not included) reduces to a one-dimensional Dirac operator

$$D_{C-S} = \hat{\epsilon}^{r\alpha\beta} [2J_{k\alpha} A_\beta + J_{\alpha\beta} A_k] \Gamma^k D_r . \quad (2.6.34)$$

Constraint term implies only a modification of the modified gamma matrices but the form of the operator remains otherwise same when extrema are in question so that one has  $D_\alpha \hat{\Gamma}^\alpha = 0$ .

2. For the extremals of Chern-Simons action the general solution of the modified Chern-Simons Dirac equation ( $\lambda^k = 0$ ) is covariantly constant with respect to the coordinate  $r$ :

$$D_r \Psi = 0 . \quad (2.6.35)$$

The solution to this condition can be written immediately in terms of a non-integrable phase factor  $P \exp(i \int A_r dr)$ , where integration is along curve with constant transversal coordinates. If  $\hat{\Gamma}^v$  is light-like vector field also  $\hat{\Gamma}^v \Psi_0$  defines a solution of  $D_{C-S}$ . This solution corresponds to a zero mode for  $D_{C-S}$  and does not contribute to the Dirac determinant (suggested to give rise to the exponent of Kähler function identified as Kähler action). Note that the dependence of these solutions on transversal coordinates of  $X_i^3$  is arbitrary which conforms with the hydrodynamic picture. The solutions of Chern-Simons-Dirac are obtained by similar integration procedure also when extremals are not in question.

The formal solution associated with a general eigenvalue  $\lambda$  can be constructed by integrating the eigenvalue equation separately along all coordinate curves. This makes sense if  $r$  indeed assigned to possibly light-like flow lines of  $B^\alpha$  or more general Beltrami field possible induced by the constraint term. There are very strong consistency conditions coming from the conditions that  $\Psi$  in the interior is constant along the flow lines of Kähler current and continuous at the ends and throats (call them collectively boundaries), where  $\Psi$  has a non-trivial variation along the flow lines of  $B^\alpha$ .

1. This makes sense only if the flow lines of the Kähler current are transversal to the boundaries so that the spinor modes at boundaries dictate the modes of the spinor field in the interior. Effective 2-dimensionality means that the spinor modes in the interior can be calculated either by starting from the throats or from the ends so that the data at either upper or lower partonic 2-surfaces dictates everything in accordance with zero energy ontology.
2. This gives an infinite number of commuting diagrams stating that the flow-line time evolution along flow lines along wormhole throats from lower partonic 2-surface to the upper one is equivalent with the flow-line time evolution along the lower end of space-time surface to interior, then along interior to the upper end of the space-time surface and then back to the upper partonic 2-surface. If the space-time surface allows a slicing by partonic 2-surfaces these conditions can be assumed for any pair of partonic 2-surfaces connected by Chern-Simons flow evolution.
3. Since the time evolution along interior keeps the spinor field as constant in the proper gauge and since the flow evolutions at the lower and upper ends are in a reverse direction, there is a strong attemptation to assume that the spinor field at the ends of the of the flow lines of Kähler magnetic field are identical apart from a gauge transformation. This leads to a particle-in-box quantization of the values of the pseudo-mass (periodic boundary conditions). These conditions will be assumed in the sequel.

These assumptions lead to the following picture about the generalized eigen modes.

1. By choosing the gauge so that covariant derivative reduces to ordinary derivative and using the constancy of  $\hat{\Gamma}^r$ , the solution of the generalized eigenvalue equation can be written as

$$\begin{aligned} \Psi &= \exp(iL(r)\hat{\Gamma}^r \lambda^k \Gamma_k) \Psi_0 , \\ L(r) &= \int_0^r \frac{1}{\sqrt{\hat{g}^{rr}}} dr . \end{aligned} \quad (2.6.36)$$

$L(r)$  can be regarded as the along flux line as defined by the effective metric defined by modified gamma matrices. If  $\lambda_k$  is linear combination of  $\Gamma^0$  and  $\Gamma^{r_M}$  it anti-commutes with  $\Gamma^r$  which contains only  $CP_2$  gamma matrices so that the pseudo-momentum is a priori arbitrary.

2. When the constraint term taking care of the electric-magnetic duality is included, also  $M^4$  gamma matrices are present. If they are in the orthogonal complement of a preferred plane  $M^2 \subset M^4$ , anti-commutativity is achieved. This assumption cannot be fully justified yet but conforms with the general physical vision. There is an obvious analogy with the condition that polarizations are in a plane orthogonal to  $M^2$ . The condition indeed states that only transversal deformations define quantum fluctuating WCW degrees of freedom contributing to the WCW Kähler metric. In  $M^8-H$  duality the preferred plane  $M^2$  is interpreted as a hyper-complex plane belonging to the tangent space of the space-time surface and defines the plane of non-physical polarizations. Also a generalization of this plane to an integrable distribution of planes  $M^2(x)$  has been proposed and one must consider also now the possibility of a varying plane  $M^2(x)$  for the pseudo-momenta. The scalar function  $\Phi$  appearing in the general solution ansatz for the field equations satisfies massless d'Alembert equation and its gradient defines a local light-like direction at space-time-level and hence a 2-D plane of the tangent space. Maybe the projection of this plane to  $M^4$  could define the preferred  $M^2$ . The minimum condition is that these planes are defined only at the ends of space-time surface and at wormhole throats.
3. If one accepts this hypothesis, one can write

$$\begin{aligned}\Psi &= \left[ \cos(L(r)\lambda) + i \sin(\lambda(r)) \hat{\Gamma}^r \lambda^k \Gamma_k \right] \Psi_0, \\ \lambda &= \sqrt{\lambda_k \lambda^k}.\end{aligned}\tag{2.6.37}$$

4. Boundary conditions should fix the spectrum of masses. If the the flow lines of Kähler current coincide with the flow lines of Kähler magnetic field or more general Beltrami current at wormhole throats one ends up with difficulties since the induced spinor fields must be constant along flow lines and only trivial eigenvalues are possible. Hence it seems that the two Beltrami fields must be transversal. This requires that at the partonic 2-surfaces the value of the induced spinor mode in the interior coincides with its value at the throat. Since the induced spinor fields in interior are constant along flow lines, one must have

$$\exp(i\lambda L_{(max)}) = 1.\tag{2.6.38}$$

This implies that one has essentially particle in a box with size defined by the effective metric

$$\lambda_n = \frac{n2\pi}{L(r_{max})}.\tag{2.6.39}$$

5. This condition cannot however hold true simultaneously for all points of the partonic 2-surfaces since  $L(r_{max})$  depends on the point of the surface. In the most general case one can consider only a subset consisting of the points for which the values of  $L(r_{max})$  are rational multiples of the value of  $L(r_{max})$  at one of the points -call it  $L_0$ . This implies the notion of number theoretical braid. Induced spinor fields are localized to the points of the braid defined by the flow lines of the Kähler magnetic field (or equivalently, any conserved current- this resolves the longstanding issue about the identification of number theoretical braids). The number of the included points depends on measurement resolution characterized somehow by the number rationals which are allowed. Only finite number of harmonics and sub-harmonics of  $L_0$  are possible so that for integer multiples the number of points is finite. If  $n_{max}L_0$  and  $L_0/n_{min}$  are the largest and smallest lengths involved, one can argue that the rationals  $n_{max}/n$ ,  $n = 1, \dots, n_{max}$  and  $n/n_{min}$ ,  $n = 1, \dots, n_{min}$  are the natural ones.

6. One can consider also algebraic extensions for which  $L_0$  is scaled from its reference value by an algebraic number so that the mass scale  $m$  must be scaled up in similar manner. The spectrum comes also now in integer multiples.  $p$ -Adic mass calculations predicts mass scales to the inverses of square roots of prime and this raises the expectation that  $\sqrt{n}$  harmonics and sub-harmonics of  $L_0$  might be necessary. Notice however that pseudo-momentum spectrum is in question so that this argument is on shaky grounds.

There is also the question about the allowed values of  $(\lambda_0, \lambda_3)$  for a given value of  $\lambda$ . This issue will be discussed in the next section devoted to the attempt to calculate the Dirac determinant assignable to this spectrum: suffice it to say that integer valued spectrum is the first guess implying that the pseudo-momenta satisfy  $n_0^2 - n_3^2 = n^2$  and therefore correspond to Pythagorean triangles. What is remarkable that the notion of number theoretic braid pops up automatically from the Beltrami flow hypothesis.

### 2.6.7 Possible role of Beltrami flows and symplectic invariance in the description of gauge and gravitational interactions

One of the most recent observations made by people working with twisters is the finding of Monteiro and O'Connell described in the preprint *The Kinematic Algebra From the Self-Dual Sector* [?]. The claim is that one can obtain supergravity amplitudes by replacing the color factors with kinematic factors which obey formally 2-D symplectic algebra defined by the plane defined by light-like momentum direction and complexified variable in the plane defined by polarizations. One could say that momentum and polarization dependent kinematic factors are in exactly the same role as the factors coming from Yang-Mills couplings. Unfortunately, the symplectic algebra looks rather formal object since the first coordinate is light-like coordinate and second coordinate complex transverse coordinate. It could make sense only in the complexification of Minkowski space.

In any case, this would suggest that the gravitational gauge group (to be distinguished from diffeomorphisms) is symplectic group of some kind having enormous representative power as we know from the fact that the symmetries of practically any physical system are realized in terms of symplectic transformations. According to the authors of [?] one can identify the Lie algebra of symplectic group of sphere with that of  $SU(N)$  at large  $N$  limit in suitable basis. What makes this interesting is that at large  $N$  limit non-planar diagrams which are the problem of twistor Grassmann approach vanish: this is old result of t'Hooft, which initiated the developments leading to AdS/CFT correspondence.

The symplectic group of  $\delta M_{\pm}^4 \times CP_2$  is the isometry algebra of WCW and I have proposed that the effective replacement of gauge group with this group implies the vanishing of non-planar diagrams [?]. The extension of SYM to a theory of also gravitation in TGD framework could make Yangian symmetry exact, resolve the infrared divergences, and the problems caused by non-planar diagrams. It would also imply stringy picture in finite measurement resolution. Also the the construction of the non-commutative homology and cohomology in TGD framework led to the lifting of Galois group algebras to their braided variants realized as symplectic flows [?] and to the conjecture that in finite measurement resolution the cohomology obtained in this manner represents WCW ("world of classical worlds") spinor fields (or at least something very essential about them).

It is however difficult to understand how one could generalize the symplectic structure so that also symplectic transformations involving light-like coordinate and complex coordinate of the partonic 2-surface would make sense in some sense. In fact, a more natural interpretation for the kinematic algebra would in terms of volume preserving flows which are also Beltrami flows [?, ?]. This gives a connection with quantum TGD since Beltrami flows define a basic dynamical symmetry for the preferred extremals of Kähler action which might be called Maxwellian phase.

1. Classical TGD is defined by Kähler action which is the analog of Maxwell action with Maxwell field expressed as the projection of  $CP_2$  Kähler form. The field equations are extremely non-linear and only the second topological half of Maxwell equations is satisfied. The remaining equations state conservation laws for various isometry currents. Actually much more general conservation laws are obtained.
2. As a special case one obtains solutions analogous to those for Maxwell equations but there are also other objects such as  $CP_2$  type vacuum extremals providing correlates for elementary particles and string like objects: for these solutions it does not make sense to speak about QFT

in Minkowski space-time. For the Maxwell like solutions linear superposition is lost but a superposition holds true for solutions with the same local direction of polarization and massless four-momentum. This is a very quantal outcome (in accordance with quantum classical correspondence) since also in quantum measurement one obtains final state with fixed polarization and momentum. So called massless extremals (topological light rays) analogous to wave guides containing laser beam and its phase conjugate are solutions of this kind. The solutions are very interesting since no dispersion occurs so that wave packet preserves its form and the radiation is precisely targeted.

3. Maxwellian preferred extremals decompose in Minkowskian space-time regions to regions that can be regarded as classical space-time correlates for massless particles. Massless particles are characterized by polarization direction and light-like momentum direction. Now these directions can depend on position and are characterized by gradients of two scalar functions  $\Phi$  and  $\Psi$ .  $\Phi$  defines light-like momentum direction and the square of the gradient of  $\Phi$  in Minkowski metric must vanish.  $\Psi$  defines polarization direction and its gradient is orthogonal to the gradient of  $\Phi$  since polarization is orthogonal to momentum.
4. The flow has the additional property that the coordinate associated with the flow lines integrates to a global coordinate. Beltrami flow is the term used by mathematicians. Beltrami property means that the condition  $j \wedge dj = 0$  is satisfied. In other words, the current is in the plane defined by its exterior derivative. The above representation obviously guarantees this. Beltrami property allows to assign order parameter to the flow depending only the parameter varying along flow line.

This is essential for the hydrodynamical interpretation of the preferred extremals which relies on the idea that various conservation laws hold along flow lines. For instance, super-conducting phase requires this kind of flow and velocity along flow line is gradient of the order parameter. The breakdown of super-conductivity would mean topologically the loss of the Beltrami flow property. One might say that the space-time sheets in TGD Universe represent analogs of supra flow and this property is spoiled only by the finite size of the sheets. This strongly suggests that the space-time sheets correspond to perfect fluid flows with very low viscosity to entropy ratio and one application is to the observed perfect flow behavior of quark gluon plasma.

5. The current  $J = \Phi \nabla \Psi$  has vanishing divergence if besides the orthogonality of the gradients the functions  $\Psi$  and  $\Phi$  satisfy massless d'Alembert equation. This is natural for massless field modes and when these functions represent constant wave vector and polarization also d'Alembert equations are satisfied. One can actually add to  $\nabla \Psi$  a gradient of an arbitrary function of  $\Phi$  this corresponds to  $U(1)$  gauge invariance and the addition to the polarization vector a vector parallel to light-like four-momentum. One can replace  $\Phi$  by any function of  $\Phi$  so that one has Abelian Lie algebra analogous to  $U(1)$  gauge algebra restricted to functions depending on  $\Phi$  only.

The general Beltrami flow gives as a special case the kinetic flow associated by Monteiro and O'Connell with plane waves. For ordinary plane wave with constant direction of momentum vector and polarization vector one could take  $\Phi = \cos(\phi)$ ,  $\phi = k \cdot m$  and  $\Psi = \epsilon \cdot m$ . This would give a real flow. The kinematical factor in SYM diagrams corresponds to a complexified flow  $\Phi = \exp(i\phi)$  and  $\Psi = \phi + w$ , where  $w$  is complex coordinate for polarization plane or more naturally, complexification of the coordinate in polarization direction. The flow is not unique since gauge invariance allows to modify  $\phi$  term. The complexified flow is volume preserving only in the formal algebraic sense and satisfies the analog of Beltrami condition only in Dolbeault cohomology where  $d$  is identified as complex exterior derivative ( $df = df/dz dz$  for holomorphic functions). In ordinary cohomology it fails. This formal complex flow of course does not define a real diffeomorphism at space-time level: one should replace Minkowski space with its complexification to get a genuine flow.

The finding of Monteiro and O'Connell encourages to think that the proposed more general Abelian algebra pops up also in non-Abelian YM theories. Discretization by braids would actually select single polarization and momentum direction. If the volume preserving Beltrami flows characterize the basic building bricks of radiation solutions of both general relativity and YM theories, it would not be surprising if the kinematic Lie algebra generators would appear in the vertices of YM theory and replace color factors in the transition from YM theory to general relativity. In TGD framework the



construction of vertices at partonic two-surfaces would define local kinematic factors as effectively constant ones.

## 2.7 How to define Dirac determinant?

The basic challenge is to define Dirac determinant hoped to give rise to the exponent of Kähler action associated with the preferred extremal. The reduction to almost topological QFT gives this kind of expression in terms of Chern-Simons action and one might hope of obtaining even more concrete expression from the Chern-Simons Dirac determinant. The calculation of the previous section allowed to calculate the most general spectrum of the modified Dirac operator. If the number of the eigenvalues is infinite as the naive expectation is then Dirac determinant diverges if calculated as the product of the eigenvalues and one must calculate it by using some kind of regularization procedure. Zeta function regularization is the natural manner to do this.

The following arguments however lead to a concrete vision how the regularization could be avoided and a connection with infinite primes. In fact, the manifestly finite option and the option involving zeta function regularization give Kähler functions differing only by a scaling factor and only the manifestly finite option satisfies number theoretical constraints coming from p-adicization. An explicit expression for the Dirac determinant in terms of geometric data of the orbit of the partonic 2-surface emerges.

Arithmetic quantum field theory defined by infinite emerges naturally. The lines of the generalized Feynman graphs are characterized by infinite primes and the selection rules correlating the geometries of the lines of the generalized Feynman graphs corresponds to the conservation of the sum of number theoretic momenta  $\log(p_i)$  assignable to sub-braids corresponding to different primes  $p_i$  assignable to the orbit of parton. This conforms with the vision that infinite primes indeed characterize the geometry of light-like 3-surfaces and therefore also of space-time sheets. The eigenvalues of the modified Dirac operator are proportional  $1/\sqrt{p_i}$  where  $p_i$  are the primes appearing in the definition of the p-adic prime and the interpretation as analogs of Higgs vacuum expectation values makes sense and is consistent with p-adic length scale hypothesis and p-adic mass calculations. It must be emphasized that all this is essentially due to single basic hypothesis, namely the reduction of quantum TGD to almost topological QFT guaranteed by the Beltrami ansatz for field equations and by the weak form of electric-magnetic duality.

### 2.7.1 Dirac determinant when the number of eigenvalues is infinite

At first sight the general spectrum looks the only reasonable possibility but if the eigenvalues correlate with the geometry of the partonic surface as quantum classical correspondence suggests, this conclusion might be wrong. The original hope was the number of eigenvalues would be finite so that also determinant would be finite automatically. There were some justifications for this hope in the definition of Dirac determinant based on the dimensional reduction of  $D_K$  as  $D_K = D_{K,3} + D_1$  and the identification of the generalized eigenvalues as those assigned to  $D_{K,3}$  as analogs of energy eigenvalues assignable to the light-like 3-surface. It will be found that number theoretic input could allow to achieve a manifest finiteness in the case of  $D_{C-S}$  and that this option is the only possible one if number theoretic universality is required.

If there are no constraints on the eigenvalue spectrum of  $D_{C-S}$  for a given partonic orbit, the naive definition of the determinant gives an infinite result and one must define Dirac determinant using  $\zeta$  function regularization implying that Kähler function reduces to the derivative of the zeta function  $\zeta_D(s)$  -call it Dirac Zeta- associated with the eigenvalue spectrum.

Consider now the situation when the number of eigenvalues is infinite.

1. In this kind of situation zeta function regularization is the standard manner to define the Dirac determinant. What one does is to assign zeta function to the spectrum- let us call it Dirac zeta function and denote by  $\zeta_D(s)$ - as

$$\zeta_D(s) = \sum_k \lambda_k^{-s} . \quad (2.7.1)$$

If the eigenvalue  $\lambda_k$  has degeneracy  $g_k$  it appears  $g_k$  times in the sum. In the case of harmonic oscillator one obtains Riemann zeta for which sum representation converges only for  $Re(s) \geq 1$ . Riemann zeta can be however analytically continued to the entire complex plane and the idea is that this can be done also in the more general case.

2. By the basic conjecture Kähler function corresponds to the logarithm of the Dirac determinant and equals to the sum of the logarithms of the eigenvalues

$$K = \log\left(\prod \lambda_k\right) = -\frac{d\zeta_D}{ds} \Big|_{s=0} . \quad (2.7.2)$$

The expression on the left hand side diverges if taken as such but the expression on the right had side based on the analytical continuation of the zeta function is completely well-defined and finite quantity. Note that the replacement of eigenvalues  $\lambda_k$  by their powers  $\lambda_k^n$  -or equivalently the increase of the degeneracy by a factor  $n$  - brings in only a factor  $n$  to  $K$ :  $K \rightarrow nK$ .

3. Dirac determinant involves in the minimal situation only the integer multiples of pseudo-mass scale  $\lambda = 2\pi/L_{min}$ . One can consider also rational and even algebraic multiples  $qL_{min} < L_{max}$ ,  $q \geq 1$ , of  $L_{min}$  so that one would have several integer spectra simultaneously corresponding to different braids. Here  $L_{min}$  and  $L_{max}$  are the extrema of the braid strand length determined in terms of the effective metric as  $L = \int (\hat{g}^{rr})^{-1/2} dr$ . The question what multiples are involved will be needed later.
4. Each rational or algebraic multiple of  $L_{min}$  gives to the zeta function a contribution which is of same form so that one has

$$\zeta_D = \sum_q \zeta(\log(qx)s) , \quad x = \frac{L_{min}}{R} , \quad 1 \leq q < \frac{L_{max}}{L_{min}} . \quad (2.7.3)$$

Kähler function can be expressed as

$$K = \sum_n \log(\lambda_n) = -\frac{d\zeta_D(s)}{ds} = -\sum_q \log(qx) \frac{d\zeta(s)}{ds} \Big|_{s=0} , \quad x = \frac{L_{min}}{R} . \quad (2.7.4)$$

What is remarkable that the number theoretical details of  $\zeta_D$  determine only the overall scaling factor of Kähler function and thus the value of Kähler coupling strength, which would be purely number theoretically determined if the hypothesis about the role of infinite primes is correct. Also the value of  $R$  is irrelevant since it does not affect the Kähler metric.

5. The dependence of Kähler function on WCW degrees of freedom would be coded completely by the dependence of the length scales  $qL_{min}$  on the complex coordinates of WCW: note that this dependence is different for each scale. This is reminiscent of the coding of the shape of the drum (or more generally - manifold) by the spectrum of its eigen frequencies. Now Kähler geometry would code for the dependence of the spectrum on the shape of the drum defined by the partonic 2-surface and the 4-D tangent space distribution associated with it.

What happens at the limit of vacuum extremals serves as a test for the identification of Kähler function as Dirac determinant. The weak form of electric magnetic duality implies that all components of the induced Kähler field vanish simultaneously if Kähler magnetic field cancels. In the modified Chern-Simons Dirac equation one obtains  $L = \int (\hat{g}^{rr})^{-1/2} dr$ . The modified gamma matrix  $\hat{\Gamma}^r$  approaches a finite limit when Kähler magnetic field vanishes

$$\hat{\Gamma}^r = \epsilon^{r\beta\gamma} (2J_{\beta k} A_\gamma + J_{\beta\gamma} A_k) \Gamma^k \rightarrow 2\epsilon^{r\beta\gamma} J_{\beta k} \Gamma^k . \quad (2.7.5)$$

The relevant component of the effective metric is  $\hat{g}^{rr}$  and is given by

$$\hat{g}^{rr} = (\hat{\Gamma}^r)^2 = 4\epsilon^{r\beta\gamma}\epsilon^{r\mu\nu}J_{\beta k}J_{\mu}^k A_{\gamma}A_{\nu} . \quad (2.7.6)$$

The limit is non-vanishing in general and therefore the eigenvalues remain finite also at this limit as also the parameter  $L_{min} = \int (\hat{g}^{rr})^{-1/2} dr$  defining the minimum of the length of the braid strand defined by Kähler magnetic flux line in the effective metric unless  $\hat{g}^{rr}$  goes to zero everywhere inside the partonic surface. Chern-Simons action and Kähler action vanish for vacuum extremals so that in this case one could require that Dirac determinant approaches to unity in a properly chosen gauge. Dirac determinant should approach to unit for vacuum extremals indeed approaches to unity since there are no finite eigenvalues at the limit  $\hat{g}^{rr} = 0$ .

## 2.7.2 Hyper-octonionic primes

Before detailed discussion of the hyper-octonionic option it is good to consider the basic properties of hyper-octonionic primes.

1. Hyper-octonionic primes are of form

$$\Pi_p = (n_0, n_3, n_1, n_2, \dots, n_7) , \quad \Pi_p^2 = n_0^2 - \sum_i n_i^2 = p \text{ or } p^2 . \quad (2.7.7)$$

2. Hyper-octonionic primes have a standard representation as hyper-complex primes. The Minkowski norm squared factorizes into a product as

$$n_0^2 - n_3^2 = (n_0 + n_3)(n_0 - n_3) . \quad (2.7.8)$$

If one has  $n_3 \neq 0$ , the prime property implies  $n_0 - n_3 = 1$  so that one obtains  $n_0 = n_3 + 1$  and  $2n_3 + 1 = p$  giving

$$(n_0, n_3) = ((p+1)/2, (p-1)/2) . \quad (2.7.9)$$

Note that one has  $(p+1)/2$  odd for  $p \bmod 4 = 1$  and  $(p+1)/2$  even for  $p \bmod 4 = 3$ ). The difference  $n_0 - n_3 = 1$  characterizes prime property.

If  $n_3$  vanishes the prime property implies equivalence with ordinary prime and one has  $n_0^2 = p^2$ . These hyper-octonionic primes represent particles at rest.

3. The action of a discrete subgroup  $G(p)$  of the octonionic automorphism group  $G_2$  generates form hyper-complex primes with  $n_3 \neq 0$  further hyper-octonionic primes  $\Pi(p, k)$  corresponding to the same value of  $n_0$  and  $p$  and for these the integer valued projection to  $M^2$  satisfies  $n_0^2 - n_3^2 = n > p$ . It is also possible to have a state representing the system at rest with  $(n_0, n_3) = ((p+1)/2, 0)$  so that the pseudo-mass varies in the range  $[\sqrt{p}, (p+1)/2]$ . The subgroup  $G(n_0, n_3) \subset SU(3)$  leaving invariant the projection  $(n_0, n_3)$  generates the hyper-octonionic primes corresponding to the same value of mass for hyper-octonionic primes with same Minkowskian length  $p$  and pseudo-mass  $\lambda = n \geq \sqrt{p}$ .
4. One obtains two kinds of primes corresponding to the lengths of pseudo-momenta equal to  $p$  or  $\sqrt{p}$ . The first kind of particles are always at rest whereas the second kind of particles can be brought at rest only if one interprets the pseudo-momentum as  $M^2$  projection. This brings in mind the secondary p-adic length scales assigned to causal diamonds (CDs) and the primary p-adic lengths scales assigned to particles.

If the  $M^2$  projections of hyper-octonionic primes with length  $\sqrt{p}$  characterize the allowed basic momenta,  $\zeta_D$  is sum of zeta functions associated with various projections which must be in the limits dictated by the geometry of the orbit of the partonic surface giving upper and lower bounds  $L_{max}$  and  $L_{min}$  on the length  $L$ .  $L_{min}$  is scaled up to  $\sqrt{n_0^2 - n_3^2} L_{min}$  for a given projection  $(n_0, n_3)$ . In general a given  $M^2$  projection  $(n_0, n_3)$  corresponds to several hyper-octonionic primes since  $SU(3)$  rotations give a new hyper-octonionic prime with the same  $M^2$  projection. This leads to an inconsistency unless one has a good explanation for why some basic momentum can appear several times. One might argue that the spinor mode is degenerate due to the possibility to perform discrete color rotations of the state. For hyper complex representatives there is no such problem and it seems favored. In any case, one can look how the degeneracy factors for given projection can be calculated.

1. To calculate the degeneracy factor  $D(n)$  associated with given pseudo-mass value  $\lambda = n$  one must find all hyper-octonionic primes  $\Pi$ , which can have projection in  $M^2$  with length  $n$  and sum up the degeneracy factors  $D(n, p)$  associated with them:

$$\begin{aligned} D(n) &= \sum_p D(n, p) , \\ D(n, p) &= \sum_{n_0^2 - n_3^2 = p} D(p, n_0, n_3) , \\ n_0^2 - n_3^2 &= n , \quad \Pi_p^2(n_0, n_3) = n_0^2 - n_3^2 - \sum_i n_i^2 = n - \sum_i n_i^2 = p . \end{aligned} \quad (2.7.10)$$

2. The condition  $n_0^2 - n_3^2 = n$  allows only Pythagorean triangles and one must find the discrete subgroup  $G(n_0, n_3) \subset SU(3)$  producing hyper-octonions with integer valued components with length  $p$  and components  $(n_0, n_3)$ . The points at the orbit satisfy the condition

$$\sum n_i^2 = p - n . \quad (2.7.11)$$

The degeneracy factor  $D(p, n_0, n_3)$  associated with given mass value  $n$  is the number of elements of in the coset space  $G(n_0, n_3, p)/H(n_0, n_3, p)$ , where  $H(n_0, n_3, p)$  is the isotropy group of given hyper-octonionic prime obtained in this manner. For  $n_0^2 - n_3^2 = p^2$   $D(n_0, n_3, p)$  obviously equals to unity.

### 2.7.3 Three basic options for the pseudo-momentum spectrum

The calculation of the scaling factor of the Kähler function requires the knowledge of the degeneracies of the mass squared eigen values. There are three options to consider.

#### First option: all pseudo-momenta are allowed

If the degeneracy for pseudo-momenta in  $M^2$  is same for all mass values- and formally characterizable by a number  $N$  telling how many 2-D pseudo-momenta reside on mass shell  $n_0^2 - n_3^2 = m^2$ . In this case zeta function would be proportional to a sum of Riemann Zetas with scaled arguments corresponding to scalings of the basic mass  $m$  to  $m/q$ .

$$\zeta_D(s) = N \sum_q \zeta(\log(qx)s) , \quad x = \frac{L_{min}}{R} . \quad (2.7.12)$$

This option provides no idea about the possible values of  $1 \leq q \leq L_{max}/L_{min}$ . The number  $N$  is given by the integral of relativistic density of states  $\int dk/2\sqrt{k^2 + m^2}$  over the hyperbola and is logarithmically divergent so that the normalization factor  $N$  of the Kähler function would be infinite.

### Second option: All integer valued pseudomomenta are allowed

Second option is inspired by number theoretic vision and assumes integer valued components for the momenta using  $m_{max} = 2\pi/L_{min}$  as mass unit. p-Adicization motivates also the assumption that momentum components using  $m_{max}$  as mass scale are integers. This would restrict the choice of the number theoretical braids.

Integer valuedness together with masses coming as integer multiples of  $m_{max}$  implies  $(\lambda_0, \lambda_3) = (n_0, n_3)$  with on mass shell condition  $n_0^2 - n_3^2 = n^2$ . Note that the condition is invariant under scaling. These integers correspond to Pythagorean triangles plus the degenerate situation with  $n_3 = 0$ . There exists a finite number of pairs  $(n_0, n_3)$  satisfying this condition as one finds by expressing  $n_0$  as  $n_0 = n_3 + k$  giving  $2n_3k + k^2 = p^2$  giving  $n_3 < n^2/2, n_0 < n^2/2 + 1$ . This would be enough to have a finite degeneracy  $D(n) \geq 1$  for a given value of mass squared and  $\zeta_D$  would be well defined.  $\zeta_D$  would be a modification of Riemann zeta given by

$$\begin{aligned}\zeta_D &= \sum_q \zeta_1(\log(qx)s) , \quad x = \frac{L_{min}}{R} , \\ \zeta_1(s) &= \sum g_n n^{-s} , \quad g_n \geq 1 .\end{aligned}\tag{2.7.13}$$

For generalized Feynman diagrams this option allows conservation of pseudo-momentum and for loops no divergences are possible since the integral over two-dimensional virtual momenta is replaced with a sum over discrete mass shells containing only a finite number of points. This option looks thus attractive but requires a regularization. On the other hand, the appearance of a zeta function having a strong resemblance with Riemann zeta could explain the finding that Riemann zeta is closely related to the description of critical systems. This point will be discussed later.

### Third option: Infinite primes code for the allowed mass scales

According to the proposal of [?] , [?] the hyper-complex parts of hyper-octonionic primes appearing in their infinite counterparts correspond to the  $M^2$  projections of real four-momenta. This hypothesis suggests a very detailed map between infinite primes and standard model quantum numbers and predicts a universal mass spectrum [?] . Since pseudo-momenta are automatically restricted to the plane  $M^2$ , one cannot avoid the question whether they could actually correspond to the hyper-octonionic primes defining the infinite prime. These interpretations need not of course exclude each other. This option allows several variants and at this stage it is not possible to exclude any of these options.

1. One must choose between two alternatives for which pseudo-momentum corresponds to hyper-complex prime serving as a canonical representative of a hyper-octonionic prime or a projection of hyper-octonionic prime to  $M^2$ .
2. One must decide whether one allows a) only the momenta corresponding to hyper-complex primes, b) also their powers (p-adic fractality), or c) all their integer multiples ("Riemann option").

One must also decide what hyper-octonionic primes are allowed.

1. The first guess is that all hyper-complex/hyper-octonionic primes defining length scale  $\sqrt{p}L_{min} \leq L_{max}$  or  $pL_{min} \leq L_{max}$  are allowed. p-Adic fractality suggests that also the higher p-adic length scales  $p^{n/2}L_{min} < L_{max}$  and  $p^n L_{min} < L_{max}$ ,  $n \geq 1$ , are possible.

It can however happen that no primes are allowed by this criterion. This would mean vanishing Kähler function which is of course also possible since Kähler action can vanish (for instance, for massless extremals). It seems therefore safer to allow also the scale corresponding to the trivial prime  $(n_0, n_3) = (1, 0)$  (1 is formally prime because it is not divisible by any prime different from 1) so that at least  $L_{min}$  is possible. This option also allows only rather small primes unless the partonic 2-surface contains vacuum regions in which case  $L_{max}$  is infinite: in this case all primes would be allowed and the exponent of Kähler function would vanish.

2. The hypothesis that only the hyper-complex or hyper-octonionic primes appearing in the infinite hyper-octonionic prime are possible looks more reasonable since large values of  $p$  would be possible and could be identified in terms of the p-adic length scale hypothesis. All hyper-octonionic primes appearing in infinite prime would be possible and the geometry of the orbit of the partonic 2-surface would define an infinite prime. This would also give a concrete physical interpretation for the earlier hypothesis that hyper-octonionic primes appearing in the infinite prime characterize partonic 2-surfaces geometrically. One can also identify the fermionic and purely bosonic primes appearing in the infinite prime as braid strands carrying fermion number and purely bosonic quantum numbers. This option will be assumed in the following.

### 2.7.4 Expression for the Dirac determinant for various options

The expressions for the Dirac determinant for various options can be deduced in a straightforward manner. Numerically Riemann option and manifestly finite option do not differ much but their number theoretic properties are totally different.

#### Riemann option

All integer multiples of these basic pseudo-momenta would be allowed for Riemann option so that  $\zeta_D$  would be sum of Riemann zetas with arguments scaled by the basic pseudo-masses coming as inverses of the basic length scales for braid strands. For the option involving only hyper-complex primes the formula for  $\zeta_D$  reads as

$$\zeta_D = \zeta(\log(x_{min}s)) + \sum_{i,n} \zeta(\log(x_{i,n}s)) + \sum_{i,n} \zeta(\log(y_{i,n}s)) ,$$

$$x_{i,n} = p_i^{n/2} x_{min} \leq x_{max} , \quad p_i \geq 3 , \quad y_{i,n} = p_i^n x_{min} \leq x_{max} \cdot p_i \geq 2 ,$$
(2.7.14)

$L_{max}$  *resp.*  $L_{min}$  is the maximal *resp.* minimal length  $L = \int (\hat{g}^{rr})^{-1/2} dr$  for the braid strand defined by the flux line of the Kähler magnetic field in the effective metric. The contributions correspond to the effective hyper-complex prime  $p_1 = (1, 0)$  and hyper-complex primes with Minkowski lengths  $\sqrt{p}$  ( $p \geq 3$ ) and  $p$ ,  $p \geq 2$ . If also higher p-adic length scales  $L_n = p^{n/2} L_{min} < L_{max}$  and  $L_n = p^n L_{min} < L_{max}$ ,  $n > 1$ , are allowed there is no further restriction on the summation. For the restricted option only  $L_n$ ,  $n = 0, 2$  is allowed.

The expressions for the Kähler function and its exponent reads as

$$K = k(\log(x_{min}) + \sum_i \log(x_i) + \sum_i \log(y_i)) ,$$

$$\exp(K) = \left(\frac{1}{x_{min}}\right)^k \times \prod_i \left(\frac{1}{x_i}\right)^k \times \prod_i \left(\frac{1}{y_i}\right)^k ,$$

$$x_i \leq x_{max} , \quad y_i \leq x_{max} , \quad k = -\frac{d\zeta(s)}{ds} \Big|_{s=0} = \frac{1}{2} \log(2\pi) \simeq .9184 .$$
(2.7.15)

From the point of view of p-adicization program the appearance of strongly transcendental numbers in the normalization factor of  $\zeta_D$  is not a well-come property.

If the scaling of the WCW Kähler metric by  $1/k$  is a legitimate procedure it would allow to get rid of the transcendental scaling factor  $k$  and this scaling would cancel also the transcendental from the exponent of Kähler function. The scaling is not however consistent with the view that Kähler coupling strength determines the normalization of the WCW metric.

This formula generalizes in a rather obvious manner to the cases when one allows  $M^2$  projections of hyper-octonionic primes.

### Manifestly finite options

The options for which one does not allow summation over all integer multiples of the basic momenta characterized by the canonical representatives of hyper-complex primes or their projections to  $M^2$  are manifestly finite. They differ from the Riemann option only in that the normalization factor  $k \simeq .9184$  defined by the derivative Riemann Zeta at origin is replaced with  $k = 1$ . This would mean manifest finiteness of  $\zeta_D$ . Kähler function and its exponent are given by

$$\begin{aligned} K &= k(\log(x_{min}) + \sum_i \log(x_i) + \sum_i \log(y_i)) , \quad x_i \leq x_{max} , \quad y_i \leq x_{max} , \\ \exp(K) &= \frac{1}{x_{min}} \times \prod_i \frac{1}{x_i} \times \prod_i \frac{1}{y_i} . \end{aligned} \tag{2.7.16}$$

Numerically the Kähler functions do not differ much since their ratio is .9184. Number theoretically these functions are however completely different. The resulting dependence involves only square roots of primes and is an algebraic function of the lengths  $p_i$  and rational function of  $x_{min}$ . p-Adicization program would require rational values of the lengths  $x_{min}$  in the intersection of the real and p-adic worlds if one allows algebraic extension containing the square roots of the primes involved. Note that in p-adic context this algebraic extension involves two additional square roots for  $p > 2$  if one does not want square root of  $p$ . Whether one should allow for  $R_p$  also extension based on  $\sqrt{p}$  is not quite clear. This would give 8-D extension.

For the more general option allowing all projections of hyper-complex primes to  $M^2$  the general form of Kähler function is same. Instead of pseudo-masses coming as primes and their square roots one has pseudomasses coming as square roots of some integers  $n \leq p$  or  $n \leq p^2$  for each  $p$ . In this case the conservation laws are not so strong.

Note that in the case of vacuum extremals  $x_{min} = \infty$  holds true so that there are no primes satisfying the condition and Kähler function vanishes as it indeed should.

### More concrete picture about the option based on infinite primes

The identification of pseudo-momenta in terms of infinite primes suggests a rather concrete connection between number theory and physics.

1. One could assign the finite hyper-octonionic primes  $\Pi_i$  making the infinite prime to the sub-braids identified as Kähler magnetic flux lines with the same length  $L$  in the effective metric. The primes assigned to the finite part of the infinite prime correspond to single fermion and some number of bosons. The primes assigned to the infinite part correspond to purely bosonic states assignable to the purely bosonic braid strands. Purely bosonic state would correspond to the action of a WCW Hamiltonian to the state.

This correspondence can be expanded to include all quantum numbers by using the pair of infinite primes corresponding to the "vacuum primes"  $X \pm 1$ , where  $X$  is the product of all finite primes [?]. The only difference with respect to the earlier proposal is that physical momenta would be replaced by pseudo-momenta.

2. Different primes  $p_i$  appearing in the infinite prime would correspond to their own sub-braids. For each sub-braid there is a  $N$ -fold degeneracy of the generalized eigen modes corresponding to the number  $N$  of braid strands so that many particle states are possible as required by the braid picture.
3. The correspondence of infinite primes with the hierarchy of Planck constants could allow to understand the fermion-many boson states and many boson states assigned with a given finite prime in terms of many-particle states assigned to  $n_a$  and  $n_b$ -sheeted singular covering spaces of  $CD$  and  $CP_2$  assignable to the two infinite primes. This interpretation requires that only single p-adic prime  $p_i$  is realized as quantum state meaning that quantum measurement always selects a particular p-adic prime  $p_i$  (and corresponding sub-braid) characterizing the p-adicity of the quantum state. This selection of number field behind p-adic physics responsible for cognition looks very plausible.

4. The correspondence between pairs of infinite primes and quantum states [?] allows to interpret color quantum numbers in terms of the states associated with the representations of a finite subgroup of  $SU(3)$  transforming hyper-octonionic primes to each other and preserving the  $M^2$  pseudo-momentum. Same applies to  $SO(3)$ . The most natural interpretation is in terms of wave functions in the space of discrete  $SU(3)$  and  $SO(3)$  transforms of the partonic 2-surface. The dependence of the pseudo-masses on these quantum numbers is natural so that the projection hypothesis finds support from this interpretation.
5. The infinite prime characterizing the orbit of the partonic 2-surface would thus code which multiples of the basic mass  $2\pi/L_{min}$  are possible. Either the  $M^2$  projections of hyper-octonionic primes or their hyper-complex canonical representatives would fix the basic  $M^2$  pseudo-momenta for the corresponding number theoretic braid associated. In the reverse direction the knowledge of the light-like 3-surface, the  $CD$  and  $CP_2$  coverings, and the number of the allowed discrete  $SU(3)$  and  $SU(2)$  rotations of the partonic 2-surface would dictate the infinite prime assignable to the orbit of the partonic 2-surface.

One would also like to understand whether there is some kind of conservation laws associated with the pseudo-momenta at vertices. The arithmetic QFT assignable to infinite primes would indeed predict this kind of conservation laws.

1. For the manifestly finite option the ordinary conservation of pseudo-momentum conservation at vertices is not possible since the addition of pseudo-momenta does not respect the condition  $n_0 - n_3 = 1$ . In fact, this difference in the sum of hyper-complex prime momenta tells how many momenta are present. If one applies the conservation law to the sum of the pseudo-momenta corresponding to different primes and corresponding braids, one can have reactions in which the number of primes involved is conserved. This would give the selection rule  $\sum_1^N p_i = \sum_1^N p_f$ . These reactions have interpretation in terms of the geometry of the 3-surface representing the line of the generalized Feynman diagram.
2. Infinite primes define an arithmetic quantum field theory in which the total momentum defined as  $\sum n_i \log(p_i)$  is a conserved quantity. As matter fact, each prime  $p_i$  would define a separately conserved momentum so that there would be an infinite number of conservation laws. If the sum  $\sum_i \log(p_i)$  is conserved in the vertex, the primes  $p_i$  associated with the incoming particle are shared with the outgoing particles so that also the total momentum is conserved. This looks the most plausible option and would give very powerful number theoretical selection rules at vertices since the collection of primes associated with incoming line would be union of the collections associated with the outgoing lines and also total pseudo-momentum would be conserved.
3. For the both Riemann zeta option and manifestly finite options the arithmetic QFT associated with infinite primes would be realized at the level of pseudo-momenta meaning very strong selection rules at vertices coding for how the geometries of the partonic lines entering the vertex correlate. WCW integration would reduce for the lines of Feynman diagram to a sum over light-like 3-surfaces characterized by  $(x_{min}, x_{max})$  with a suitable weighting factor and the exponent of Kähler function would give an exponential damping as a function of  $x_{min}$ .

### Which option to choose?

One should be able to make two choices. One must select between hyper-complex representations and the projections of hyper-octonionic primes and between the manifestly finite options and the one producing Riemann zeta?

Hyper-complex option seems to be slightly favored over the projection option.

1. The appearance of the scales  $\sqrt{p_i} x_{min}$  and possibly also their  $p^n$  multiples brings in mind p-adic length scales coming as  $\sqrt{p^n}$  multiples of  $CP_2$  length scale. The scales  $p_i x_{min}$  associated with hyper-complex primes reducing to ordinary primes in turn bring in mind the size scales assignable to  $CD$ s. The hierarchy of Planck constants implies also  $\hbar/\hbar_0 = \sqrt{n_a n_b}$  multiples of these length scales but mass scales would not depend on  $n_a$  and  $n_b$  [K71]. For large values of  $p$  the pseudo-momenta are almost light-like for hyper-complex option whereas the projection option allows also states at rest.



2. Hyper-complex option predicts that only the p-adic pseudo-mass scales appear in the partition function and is thus favored by the p-adic length scale hypothesis. Projection option predicts also the possibility of the mass scales (not all of them) coming as  $1/\sqrt{n}$ . These mass scales are however not predicted by the hierarchy of Planck constants.
3. The same pseudo-mass scale can appear several times for the projection option. This degeneracy corresponds to the orbit of the hyper-complex prime under the subgroup of  $SU(3)$  respecting integer property. Similar statement holds true in the case of  $SO(3)$ : these groups are assigned to the two infinite primes characterizing parton. The natural assignment of this degeneracy is to the discrete color rotational and rotational degrees associated with the partonic 2-surface itself rather than spinor modes at fixed partonic 2-surface. That the pseudo-mass would depend on color and angular momentum quantum numbers would make sense.

Consider next the arguments in favor of the manifestly finite option.

1. The manifestly finite option is admittedly more elegant than the one based on Riemann zeta and also guarantees that no additional loop summations over pseudo-momenta are present. The strongest support for the manifestly finite option comes from number theoretical universality.
2. One could however argue that the restriction of the pseudo-momenta to a finite number is not consistent with the modified Dirac-Chern-Simons equation. Quantum classical correspondence however implies correlation between the geometry of the partonic orbits and the pseudo-momenta and the summation over all prime valued pseudo-momenta is present but with a weighting factor coming from Kähler function implying exponential suppression.

The Riemann zeta option could be also defended.

1. The numerical difference of the normalization factors of the Kähler function is however only about 8 per cent and quantum field theorists might interpret the replacement the length scales  $x_i$  and  $y_i$  with  $x_i^d$  and  $y_i^d$ ,  $d \simeq .9184$ , in terms of an anomalous dimension of these length scales. Could one say that radiative corrections mean the scaling of the original preferred coordinates so that one could still have consistency with number theoretic universality?
2. Riemann zeta with a non-vanishing argument could have also other applications in quantum TGD. Riemann zeta has interpretation as a partition function and the zeros of partition functions have interpretation in terms of phase transitions. The quantum criticality of TGD indeed corresponds to a phase transition point. There is also experimental evidence that the distribution of zeros of zeta corresponds to the distribution of energies of quantum critical systems in the sense that the energies correspond to the imaginary parts of the zeros of zeta [?].

The first explanation would be in terms of the analogs of the harmonic oscillator coherent states with integer multiple of the basic momentum taking the role of occupation number of harmonic oscillator and the zeros  $s = 1/2 + iy$  of  $\zeta$  defining the values of the complex coherence parameters. TGD inspired strategy for the proof of Riemann hypothesis indeed leads to the identification of the zeros as coherence parameters rather than energies as in the case of Hilbert-Polya hypothesis [?] and the vanishing of the zeta at zero has interpretation as orthogonality of the state with respect to the state defined by a vanishing coherence parameter interpreted as a tachyon. One should demonstrate that the energies of quantum states can correspond to the imaginary parts of the coherence parameters.

Second interpretation could be in terms of quantum critical zero energy states for which the "complex square root of density matrix" defines time-like entanglement coefficients of  $M$ -matrix. The complex square roots of the probabilities defined by the coefficient of harmonic oscillator states (perhaps identifiable in terms of the multiples of pseudo-momentum) in the coherent state defined by the zero of  $\zeta$  would define the  $M$ -matrix in this situation. Energy would correspond also now to the imaginary part of the coherence parameter. The norm of the state would be completely well-defined.

### Representation of configuration Kähler metric in terms of eigenvalues of $D_{C-S}$

A surprisingly concrete connection of the configuration space metric in terms of generalized eigenvalue spectrum of  $D_{C-S}$  results. From the general expression of Kähler metric in terms of Kähler function

$$G_{k\bar{l}} = \partial_k \partial_{\bar{l}} K = \frac{\partial_k \partial_{\bar{l}} \exp(K)}{\exp(K)} - \frac{\partial_k \exp(K)}{\exp(K)} \frac{\partial_{\bar{l}} \exp(K)}{\exp(K)}, \quad (2.7.17)$$

and from the expression of  $\exp(K) = \prod_i \lambda_i$  as the product of finite number of eigenvalues of  $D_{C-S}$ , the expression

$$G_{k\bar{l}} = \sum_i \frac{\partial_k \partial_{\bar{l}} \lambda_i}{\lambda_i} - \frac{\partial_k \lambda_i}{\lambda_i} \frac{\partial_{\bar{l}} \lambda_i}{\lambda_i} \quad (2.7.18)$$

for the configuration space metric follows. Here complex coordinates refer to the complex coordinates of configuration space. Hence the knowledge of the eigenvalue spectrum of  $D_{C-S}(X^3)$  as function of some complex coordinates of configuration space allows to deduce the metric to arbitrary accuracy. If the above arguments are correct the calculation reduces to the calculation of the derivatives of  $\log(\sqrt{p}L_{min}/R)$ , where  $L_{min}$  is the length of the Kähler magnetic flux line between partonic 2-surfaces with respect to the effective metric defined by the anti-commutators of the modified gamma matrices. Note that these length scales have different dependence on WCW coordinates so that one cannot reduce everything to  $L_{min}$ . Therefore one would have explicit representation of the basic building brick of WCW Kähler metric in terms of the geometric data associated with the orbit of the partonic 2-surface.

### The formula for the Kähler action of $CP_2$ type vacuum extremals is consistent with the Dirac determinant formula

The first killer test for the formula of Kähler function in terms of the Dirac determinant based on infinite prime hypothesis is provided by the action of  $CP_2$  type vacuum extremals. One of the first attempts to make quantitative predictions in TGD framework was the prediction for the gravitational constant. The argument went as follows.

1. For dimensional reasons gravitational constant must be proportional to p-adic length scale squared, where  $p$  characterizes the space-time sheet of the graviton. It must be also proportional to the square of the vacuum function for the graviton representing a line of generalized Feynman diagram and thus to the exponent  $\exp(-2K)$  of Kähler action for topologically condensed  $CP_2$  type vacuum extremals with very long projection. If topological condensation does not reduce much of the volume of  $CP_2$  type vacuum extremal, the action is just Kähler action for  $CP_2$  itself. This gives

$$\hbar_0 G = L_p^2 \exp(2L_K(CP_2)) = pR^2 \exp(2L_K(CP_2)). \quad (2.7.19)$$

2. Using as input the constraint  $\alpha_K \simeq \alpha_{em} \sim 1/137$  for Kähler coupling strengths coming from the comparison of the TGD prediction for the rotation velocity of distant galaxies around galactic nucleus and the p-adic mass calculation for the electron mass, one obtained the result

$$\exp(2L_K(CP_2)) = \frac{1}{p \times \prod_{p_i \leq 23} p_i}. \quad (2.7.20)$$

The product contains the product of all primes smaller than 24 ( $p_i \in \{2, 3, 5, 7, 11, 13, 17, 19, 23\}$ ). The expression for the Kähler function would be just of the form predicted by the Dirac determinant formula with  $L_{min}$  replaced with  $CP_2$  length scale. As a matter fact, this was the first indication that particles are characterized by several p-adic primes but that only one of them is "active". As explained, the number theoretical state function reduction explains this.

3. The same formula for the gravitational constant would result for any prime  $p$  but the value of Kähler coupling strength would depend on prime  $p$  logarithmically for this option. I indeed proposed that this formula fixes the discrete evolution of the Kähler coupling strength as function of p-adic prime from the condition that gravitational constant is renormalization group invariant quantity but gave up this hypothesis later. It is wisest to keep an agnostic attitude to this issue.
4. I also made numerous brave attempts to deduce an explicit formula for Kähler coupling strength. The general form of the formula is

$$\frac{1}{\alpha_K} = k \log(K^2), \quad K^2 = p \times 2 \times 3 \times 5 \dots \times 23 \quad . \quad (2.7.21)$$

The problem is the exact value of  $k$  cannot be known precisely and the guesses for its value depend on what one means with number theoretical universality. Should Kähler action be a rational number? Or is it Kähler function which is rational number (it is for the Dirac determinant option in this particular case). Is Kähler coupling strength  $g_K^2/4\pi$  or  $g_K^2$  a rational number? Some of the guesses were  $k = \pi/4$  and  $k = 137/107$ . The facts that the value of Kähler action for the line of a generalized diagram is not exactly  $CP_2$  action and the value of  $\alpha_K$  is not known precisely makes these kind of attempts hopeless in absence of additional ideas.

Also other elementary particles -in particular exchanged bosons- should involve the exponent of Kähler action for  $CP_2$  type vacuum extremal. Since the values of gauge couplings are gigantic as compared to the expression of the gravitational constant the value of Kähler action must be rather small form them.  $CP_2$  type vacuum extremals must be short in the sense that  $L_{min}$  in the effective metric is very short. Note however that the p-adic prime characterizing the particle according to p-adic mass calculations would be large also now. One can of course ask whether this p-adic prime characterizes the gravitational space-time sheets associated with the particle and not the particle itself. The assignment of p-adic mass calculations with thermodynamics at gravitational space-time sheets of the particle would be indeed natural. The value of  $\alpha_K$  would depend on  $p$  in logarithmic manner for this option. The topological condensation of could also eat a lot of  $CP_2$  volume for them.

### Eigenvalues of $D_{C-S}$ as vacuum expectations of Higgs field?

Infinite prime hypothesis implies the analog of p-adic length scale hypothesis but since pseudo-momenta are in question, this need not correspond to the p-adic length scale hypothesis for the actual masses justified by p-adic thermodynamics. Note also that  $L_{min}$  does not correspond to  $CP_2$  length scale. This is actually not a problem since the effective metric is not  $M^4$  metric and one can quite well consider the possibility that  $L_{min}$  corresponds to  $CP_2$  length scale in the the induced metric. The reason is that light-like 3- surface is in question the distance along the Kähler magnetic flux line reduces essentially to a distance along the partonic 2-surface having size scale of order  $CP_2$  length for the partonic 2-surfaces identified as wormhole throats. Therefore infinite prime can code for genuine p-adic length scales associated with the light-like 3-surface and quantum states would correspond by number theoretical state function reduction hypothesis to single ordinary prime.

Support for this identification comes also from the expression of gravitational constant deduced from p-adic length scale hypothesis. The result is that gravitational constant is assumed to be proportional to have the expression  $G = L_p^2 \exp(-2S_K(CP_2))$ , where  $p$  characterizes graviton or the space-time sheet mediating gravitational interaction and exponent gives Kähler action for  $CP_2$  type vacuum extremal representing graviton. The argument allows to identify the p-adic prime  $p = M_{127}$  associated with electron (largest Mersenne prime which does not correspond to super-astronomical length scale) as the p-adic prime characterizing also graviton. The exponent of Kähler action is proportional to  $1/p$  which conforms with the general expression for Kähler function. I have considered several identifications of the numerical factor and one of them has been as product of primes  $2 \leq p \leq 23$  assuming that somehow the primes  $\{2, \dots, 23, p\}$  characterize graviton. This guess is indeed consistent with the prediction of the infinite-prime hypothesis.

The first guess inspired by the p-adic mass calculations is that the squares  $\lambda_i^2$  of the eigenvalues of  $D_{C-S}$  could correspond to the conformal weights of ground states. Another natural physical

interpretation of  $\lambda$  is as an analog of the Higgs vacuum expectation. The instability of the Higgs=0 phase would correspond to the fact that  $\lambda = 0$  mode is not localized to any region in which electromagnetic field or induced Kähler field is non-vanishing. By the previous argument one would have order of magnitude estimate  $h_0 = \sqrt{2\pi/L_{min}}$ .

1. The vacuum expectation value of Higgs is only proportional to the scale of  $\lambda$ . Indeed, Higgs and gauge bosons as elementary particles correspond to wormhole contacts carrying fermion and anti-fermion at the two wormhole throats and must be distinguished from the space-time correlate of its vacuum expectation as something proportional to  $\lambda$ . For free fermions the vacuum expectation value of Higgs does not seem to be even possible since free fermions do not correspond to wormhole contacts between two space-time sheets but possess only single wormhole throat (p-adic mass calculations are consistent with this). If fermion suffers topological condensation as indeed assumed to do in interaction region, a wormhole contact is generated and makes possible the generation of Higgs vacuum expectation value.
2. Physical considerations suggest that the vacuum expectation of Higgs field corresponds to a particular eigenvalue  $\lambda_i$  of modified Chern-Simons Dirac operator so that the eigenvalues  $\lambda_i$  would define TGD counterparts for the minima of Higgs potential. For the minimal option one has only a finite number of pseudo-mass eigenvalues inversely proportional  $\sqrt{p}$  so that the identification as a Higgs vacuum expectation is consistent with the p-adic length scale hypothesis. Since the vacuum expectation of Higgs corresponds to a condensate of wormhole contacts giving rise to a coherent state, the vacuum expectation cannot be present for topologically condensed  $CP_2$  type vacuum extremals representing fermions since only single wormhole throat is involved. This raises a hen-egg question about whether Higgs contributes to the mass or whether Higgs is only a correlate for massivation having description using more profound concepts. From TGD point of view the most elegant option is that Higgs does not give rise to mass but Higgs vacuum expectation value accompanies bosonic states and is naturally proportional to  $\lambda_i$ . With this interpretation  $\lambda_i$  could give a contribution to both fermionic and bosonic masses.
3. If the coset construction for super-symplectic and super Kac-Moody algebra implying Equivalence Principle is accepted, one encounters what looks like a problem. p-Adic mass calculations require negative ground state conformal weight compensated by Super Virasoro generators in order to obtain massless states. The tachyonicity of the ground states would mean a close analogy with both string models and Higgs mechanism.  $\lambda_i^2$  is very natural candidate for the ground state conformal weights identified but would have wrong sign. Therefore it seems that  $\lambda_i^2$  can define only a deviation of the ground state conformal weight from negative value and is positive.
4. In accordance with this  $\lambda_i^2$  would give constant contribution to the ground state conformal weight. What contributes to the thermal mass squared is the deviation of the ground state conformal weight from half-odd integer since the negative integer part of the total conformal weight can be compensated by applying Virasoro generators to the ground state. The first guess motivated by cyclotron energy analogy is that the lowest conformal weights are of form  $h_c = -n/2 + \lambda_i^2$  where the negative contribution comes from Super Virasoro representation. The negative integer part of the net conformal weight can be canceled using Super Virasoro generators but  $\Delta h_c$  would give to mass squared a contribution analogous to Higgs contribution. The mapping of the real ground state conformal weight to a p-adic number by canonical identification involves some delicacies.
5. p-Adic mass calculations are consistent with the assumption that Higgs type contribution is vanishing (that is small) for fermions and dominates for gauge bosons. This requires that the deviation of  $\lambda_i^2$  with smallest magnitude from half-odd integer value in the case of fermions is considerably smaller than in the case of gauge bosons in the scale defined by p-adic mass scale  $1/L(k)$  in question. Somehow this difference could relate to the fact that bosons correspond to pairs of wormhole throats.

### Is there a connection between p-adic thermodynamics, hierarchy of Planck constants, and infinite primes

The following observations suggest that there might be an intrinsic connection between p-adic thermodynamics, hierarchy of Planck constants, and infinite primes.

1. p-Adic thermodynamics [K39] is based on string mass formula in which mass squared is proportional to conformal weight having values which are integers apart from the contribution of the conformal weight of vacuum which can be non-integer valued. The thermal expectation in p-adic thermodynamics is obtained by replacing the Boltzman weight  $\exp(-E/T)$  of ordinary thermodynamics with p-adic conformal weight  $p^{n/T_p}$ , where  $n$  is the value of conformal weight and  $1/T_p = m$  is integer values inverse p-adic temperature. Apart from the ground state contribution and scale factor p-adic mass squared is essentially the expectation value

$$\langle n \rangle = \frac{\sum_n g(n) n p^{\frac{n}{T_p}}}{\sum_n g(n) p^{\frac{n}{T_p}}} . \quad (2.7.22)$$

$g(n)$  denotes the degeneracy of a state with given conformal weight and depends only on the number of tensor factors in the representations of Virasoro or Super-Virasoro algebra. p-Adic mass squared is mapped to its real counterpart by canonical identification  $\sum x_n p^n \rightarrow \sum x_n p^{-n}$ . The real counterpart of p-adic thermodynamics is obtained by the replacement  $p^{-\frac{n}{T_p}}$  and gives under certain additional assumptions in an excellent accuracy the same results as the p-adic thermodynamics.

2. An intriguing observation is that one could interpret p-adic and real thermodynamics for mass squared also in terms of number theoretic thermodynamics for the number theoretic momentum  $\log(p^n) = n \log(p)$ . The expectation value for this differs from the expression for  $\langle n \rangle$  only by the factor  $\log(p)$ .
3. In the proposed characterization of the partonic orbits in terms of infinite primes the primes appearing in infinite prime are identified as p-adic primes. For minimal option the p-adic prime characterizes  $\sqrt{p}$ - or  $p$ - multiple of the minimum length  $L_{min}$  of braid strand in the effective metric defined by modified Chern-Simons gamma matrix. One can consider also  $(\sqrt{p})^n$  and  $p^n$  (p-adic fractality)- and even integer multiples of  $L_{min}$  if they are below  $L_{max}$ . If light-like 3-surface contains vacuum regions arbitrary large  $p$ :s are possible since for these one has  $L_{min} \rightarrow \infty$ . Number theoretic state function reduction implies that only single  $p$  can be realized -one might say "is active"- for a given quantum state. The powers  $p_i^n$  appearing in the infinite prime have interpretation as many particle states with total number theoretic momentum  $n_i \log(p)_i$ . For the finite part of infinite prime one has one fermion and  $n_i - 1$  bosons and for the bosonic part  $n_i$  bosons. The arithmetic QFT associated with infinite primes - in particular the conservation of the number theoretic momentum  $\sum n_i \log(p_i)$  - would naturally describe the correlations between the geometries of light-like 3-surfaces representing the incoming lines of the vertex of generalized Feynman diagram. As a matter fact, the momenta associated with different primes are separately conserved so that one has infinite number of conservation laws.
4. One must assign two infinite primes to given partonic two surface so that one has for a given prime  $p$  two integers  $n_+$  and  $n_-$ . Also the hierarchy of Planck constants assigns to a given page of the Big Book two integers and one has  $\hbar = n_a n_b \hbar_0$ . If one has  $n_a = n_+$  and  $n_b = n_-$  then the reactions in which given initial number theoretic momenta  $n_{\pm, i} \log(p_i)$  is shared between final states would have concrete interpretation in terms of the integers  $n_a, n_b$  characterizing the coverings of incoming and outgoing lines.

Note that one can also consider the possibility that the hierarchy of Planck constants emerges from the basic quantum TGD. Basically due to the vacuum degeneracy of Kähler action the canonical momentum densities correspond to several values of the time derivatives of the imbedding space coordinates so that for a given partonic 2-surface there are several space-time sheets with same conserved quantities defined by isometry currents and Kähler current. This forces the introduction of  $N$ -fold covering of  $CD \times CP_2$  in order to describe the situation. The splitting of the partonic 2-surface into  $N$  pieces implies a charge fractionization during its travel to the upper end of  $CD$ . One can also develop an argument suggesting that the coverings factorize to coverings of  $CD$  and  $CP_2$  so that the number of the sheets of the covering is  $N = n_a n_b$  [?] .

These observations make one wonder whether there could be a connection between p-adic thermodynamics, hierarchy of Planck constants, and infinite primes.

1. Suppose that one accepts the identification  $n_a = n_+$  and  $n_b = n_-$ . Could one perform a further identification of these integers as non-negative conformal weights characterizing physical states so that conservation of the number theoretic momentum for a given p-adic prime would correspond to the conservation of conformal weight. In p-adic thermodynamics this conformal weight is sum of conformal weights of 5 tensor factors of Super-Virasoro algebra. The number must be indeed five and one could assign them to the factors of the symmetry group. One factor for color symmetries and two factors of electro-weak  $SU(2)_L \times U(1)$  are certainly present. The remaining two factors could correspond to transversal degrees of freedom assignable to string like objects but one can imagine also other identifications [K39].
2. If this interpretation is correct, a given conformal weight  $n = n_a = n_+$  (say) would correspond to all possible distributions of five conformal weights  $n_i$ ,  $i = 1, \dots, 5$  between the  $n_a$  sheets of covering of  $CD$  satisfying  $\sum_{i=1}^5 n_i = n_a = n_+$ . Single sheet of covering would carry only unit conformal weight so that one would have the analog of fractionization also now and a possible interpretation would be in terms of the instability of states with conformal weight  $n > 1$ . Conformal thermodynamics would also mean thermodynamics in the space of states determined by infinite primes and in the space of coverings.
3. The conformal weight assignable to the  $CD$  would naturally correspond to mass squared but there is also the conformal weight assignable to  $CP_2$  and one can wonder what its interpretation might be. Could it correspond to the expectation of pseudo mass squared characterizing the generalized eigenstates of the modified Dirac operator? Note that one should allow in the spectrum also the powers of hyper-complex primes up to some maximum power  $p^{n_{max}/2} \leq L_{max}/L_{min}$  so that Dirac determinant would be non-vanishing and Kähler function finite. From the point of conformal invariance this is indeed natural.

## 2.8 An attempt to understand preferred extremals of Kähler action

There are pressing motivations for understanding the preferred extremals of Kähler action. For instance, the conformal invariance of string models naturally generalizes to 4-D invariance defined by quantum Yangian of quantum affine algebra (Kac-Moody type algebra) characterized by two complex coordinates and therefore explaining naturally the effective 2-dimensionality [?]. The problem is however how to assign a complex coordinate with the string world sheet having Minkowskian signature of metric. One can hope that the understanding of preferred extremals could allow to identify two preferred complex coordinates whose existence is also suggested by number theoretical vision giving preferred role for the rational points of partonic 2-surfaces in preferred coordinates. The best one could hope is a general solution of field equations in accordance with the hints that TGD is integrable quantum theory.

A lot is known about properties of preferred extremals and just by trying to integrate all this understanding, one might gain new visions. The problem is that all these arguments are heuristic and rely heavily on physical intuition. The following considerations relate to the space-time regions having Minkowskian signature of the induced metric. The attempt to generalize the construction also to Euclidian regions could be very rewarding. Only a humble attempt to combine various ideas to a more coherent picture is in question.

The core observations and visions are following.

1. Hamilton-Jacobi coordinates for  $M^4$  (discussed in this chapter) define natural preferred coordinates for Minkowskian space-time sheet and might allow to identify string world sheets for  $X^4$  as those for  $M^4$ . Hamilton-Jacobi coordinates consist of light-like coordinate  $m$  and its dual defining local 2-plane  $M^2 \subset M^4$  and complex transversal complex coordinates  $(w, \bar{w})$  for a plane  $E_x^2$  orthogonal to  $M_x^2$  at each point of  $M^4$ . Clearly, hyper-complex analyticity and complex analyticity are in question.

2. Space-time sheets allow a slicing by string world sheets (partonic 2-surfaces) labelled by partonic 2-surfaces (string world sheets).
3. The quaternionic planes of octonion space containing preferred hyper-complex plane are labelled by  $CP_2$ , which might be called  $CP_2^{mod}$  [K72]. The identification  $CP_2 = CP_2^{mod}$  motivates the notion of  $M^8 - M^4 \times CP_2$  duality [?]. It also inspires a concrete solution ansatz assuming the equivalence of two different identifications of the quaternionic tangent space of the space-time sheet and implying that string world sheets can be regarded as strings in the 6-D coset space  $G_2/SU(3)$ . The group  $G_2$  of octonion automorphisms has already earlier appeared in TGD framework.
4. The duality between partonic 2-surfaces and string world sheets in turn suggests that the  $CP_2 = CP_2^{mod}$  conditions reduce to string model for partonic 2-surfaces in  $CP_2 = SU(3)/U(2)$ . String model in both cases could mean just hypercomplex/complex analyticity for the coordinates of the coset space as functions of hyper-complex/complex coordinate of string world sheet/partonic 2-surface.

The considerations of this section lead to a revival of an old very ambitious and very romantic number theoretic idea.

1. To begin with express octonions in the form  $o = q_1 + Iq_2$ , where  $q_i$  is quaternion and  $I$  is an octonionic imaginary unit in the complement of fixed a quaternionic sub-space of octonions. Map preferred coordinates of  $H = M^4 \times CP_2$  to octonionic coordinate, form an arbitrary octonion analytic function having expansion with real Taylor or Laurent coefficients to avoid problems due to non-commutativity and non-associativity. Map the outcome to a point of  $H$  to get a map  $H \rightarrow H$ . This procedure is nothing but a generalization of Wick rotation to get an 8-D generalization of analytic map.
2. Identify the preferred extremals of Kähler action as surfaces obtained by requiring the vanishing of the imaginary part of an octonion analytic function. Partonic 2-surfaces and string world sheets would correspond to commutative sub-manifolds of the space-time surface and of imbedding space and would emerge naturally. The ends of braid strands at partonic 2-surface would naturally correspond to the poles of the octonion analytic functions. This would mean a huge generalization of conformal invariance of string models to octonionic conformal invariance and an exact solution of the field equations of TGD and presumably of quantum TGD itself.

### 2.8.1 Basic ideas about preferred extremals

#### The slicing of the space-time sheet by partonic 2-surfaces and string world sheets

The basic vision is that space-time sheets are sliced by partonic 2-surfaces and string world sheets. The challenge is to formulate this more precisely at the level of the preferred extremals of Kähler action.

1. Almost topological QFT property means that the Kähler action reduces to Chern-Simons terms assignable to 3-surfaces. This is guaranteed by the vanishing of the Coulomb term in the action density implied automatically if conserved Kähler current is proportional to the instanton current with proportionality coefficient some scalar function.
2. The field equations reduce to the conservation of isometry currents. An attractive ansatz is that the flow lines of these currents define global coordinates. This means that these currents are Beltrami flows [?] so that corresponding 1-forms  $J$  satisfy the condition  $J \wedge dJ = 0$ . These conditions are satisfied if

$$J = \Phi \nabla \Psi$$

hold true for conserved currents. From this one obtains that  $\Psi$  defines global coordinate varying along flow lines of  $J$ .

3. A possible interpretation is in terms of local polarization and momentum directions defined by the scalar functions involved and natural additional conditions are that the gradients of  $\Psi$  and  $\Phi$  are orthogonal:

$$\nabla\Phi \cdot \nabla\Psi = 0 ,$$

and that the  $\Psi$  satisfies massless d'Alembert equation

$$\nabla^2\Psi = 0$$

as a consequence of current conservation. If  $\Psi$  defines a light-like vector field - in other words

$$\nabla\Psi \cdot \nabla\Psi = 0 ,$$

the light-like dual of  $\Phi$  -call it  $\Phi_c$ - defines a light-like coordinate and  $\Phi$  and  $\Phi_c$  defines a light-like plane at each point of space-time sheet.

If also  $\Phi$  satisfies d'Alembert equation

$$\nabla^2\Phi = 0 ,$$

also the current

$$K = \Psi\nabla\Phi$$

is conserved and its flow lines define a global coordinate in the polarization plane orthogonal to time-like plane defined by local light-like momentum direction.

If  $\Phi$  allows a continuation to an analytic function of the transversal complex coordinate, one obtains a coordinatization of spacetime surface by  $\Psi$  and its dual (defining hyper-complex coordinate) and  $w, \bar{w}$ . Complex analyticity and its hyper-complex variant would allow to provide space-time surface with four coordinates very much analogous with Hamilton-Jacobi coordinates of  $M^4$ .

This would mean a decomposition of the tangent space of space-time surface to orthogonal planes defined by light-like momentum and plane orthogonal to it. If the flow lines of  $J$  defined Beltrami flow it seems that the distribution of momentum planes is integrable.

4. General arguments suggest that the space-time sheets allow a slicing by string world sheets parametrized by partonic 2-surfaces or vice versa. This would mean an intimate connection with the mathematics of string models. The two complex coordinates assignable to the Yangian of affine algebra would naturally relate to string world sheets and partonic 2-surfaces and the highly non-trivial challenge is to identify them appropriately.

### Hamilton-Jacobi coordinates for $M^4$

The earlier attempts to construct preferred extremals [K9] led to the realization that so called Hamilton-Jacobi coordinates  $(m, w)$  for  $M^4$  define its slicing by string world sheets parametrized by partonic 2-surfaces.  $m$  would be pair of light-like conjugate coordinates associated with an integrable distribution of planes  $M^2$  and  $w$  would define a complex coordinate for the integrable distribution of 2-planes  $E^2$  orthogonal to  $M^2$ . There is a great temptation to assume that these coordinates define preferred coordinates for  $M^4$ .

1. The slicing is very much analogous to that for space-time sheets and the natural question is how these slicings relate. What is of special interest is that the momentum plane  $M^2$  can be defined by massless momentum. The scaling of this vector does not matter so that these planes are labelled by points  $z$  of sphere  $S^2$  telling the direction of the line  $M^2 \cap E^3$ , when one assigns rest frame and therefore  $S^2$  with the preferred time coordinate defined by the line connecting the tips of  $CD$ . This direction vector can be mapped to a twistor consisting of a spinor and its conjugate.



The complex scalings of the twistor  $(u, \bar{u}) \rightarrow \lambda u, \bar{u}/\lambda$  define the same plane. Projective twistor like entities defining  $CP_1$  having only one complex component instead of three are in question. This complex number defines with certain prerequisites a local coordinate for space-time sheet and together with the complex coordinate of  $E^2$  could serve as a pair of complex coordinates  $(z, w)$  for space-time sheet. This brings strongly in mind the two complex coordinates appearing in the expansion of the generators of quantum Yangian of quantum affine algebra [?].

2. The coordinate  $\Psi$  appearing in Beltrami flow defines the light-like vector field defining  $M^2$  distribution. Its hyper-complex conjugate would define  $\Psi_c$  and conjugate light-like direction. An attractive possibility is that  $\Phi$  allows analytic continuation to a holomorphic function of  $w$ . In this manner one would have four coordinates for  $M^4$  also for space-time sheet.
3. The general vision is that at each point of space-time surface one can decompose the tangent space to  $M^2(x) \subset M^4 = M_x^2 \times E_x^2$  representing momentum plane and polarization plane  $E^2 \subset E_x^2 \times T(CP_2)$ . The moduli space of planes  $E^2 \subset E^6$  is 8-dimensional and parametrized by  $SO(6)/SO(2) \times SO(4)$  for a given  $E_x^2$ . How can one achieve this selection and what conditions it must satisfy? Certainly the choice must be integrable but this is not the only condition.

### Space-time surfaces as quaternionic surfaces

The idea that number theory determines classical dynamics in terms of associativity condition means that space-time surfaces are in some sense quaternionic surfaces of an octonionic space-time. It took several trials before the recent form of this hypothesis was achieved.

1. Octonionic structure is defined in terms of the octonionic representation of gamma matrices of the imbedding space existing only in dimension  $D = 8$  since octonion units are in one-one correspondence with tangent vectors of the tangent space. Octonionic real unit corresponds to a preferred time axes (and rest frame) identified naturally as that connecting the tips of  $CD$ . What modified gamma matrices mean depends on variational principle for space-time surface. For volume action one would obtain induced gamma matrices. For Kähler action one obtains something different. In particular, the modified gamma matrices do not define vector basis identical with tangent vector basis of space-time surface.
2. Quaternionicity means that the modified gamma matrices defined as contractions of gamma matrices of  $H$  with canonical momentum densities for Kähler action span quaternionic sub-space of the octonionic tangent space [?]. A further condition is that each quaternionic space defined in this manner contains a preferred hyper-complex subspace of octonions.
3. The sub-space defined by the modified gamma matrices does not co-incide with the tangent space of space-time surface in general so that the interpretation of this condition is far from obvious. The canonical momentum densities need not define four independent vectors at given point. For instance, for massless extremals these densities are proportional to light-like vector so that the situation is degenerate and the space in question reduces to 2-D hyper-complex sub-space since light-like vector defines plane  $M^2$ .

The obvious questions are following.

1. Does the analog of tangent space defined by the octonionic modified gammas contain the local tangent space  $M^2 \subset M^4$  for preferred extremals? For massless extremals [K9] this condition would be true. The orthogonal decomposition  $T(X^4) = M^2 \oplus_{\perp} E^2$  can be defined at each point if this is true. For massless extremals also the functions  $\Psi$  and  $\Phi$  can be identified.
2. One should answer also the following delicate question. Can  $M^2$  really depend on point  $x$  of space-time?  $CP_2$  as a moduli space of quaternionic planes emerges naturally if  $M^2$  is *same* everywhere. It however seems that one should allow an integrable distribution of  $M_x^2$  such that  $M_x^2$  is same for all points of a given partonic 2-surface.

How could one speak about fixed  $CP_2$  (the imbedding space) at the entire space-time sheet even when  $M_x^2$  varies?

- (a) Note first that  $G_2$  defines the Lie group of octonionic automorphisms and  $G_2$  action is needed to change the preferred hyper-octonionic sub-space. Various  $SU(3)$  subgroups of  $G_2$  are related by  $G_2$  automorphism. Clearly, one must assign to each point of a string world sheet in the slicing parameterizing the partonic 2-surfaces an element of  $G_2$ . One would have Minkowskian string model with  $G_2$  as a target space. As a matter fact, this string model is defined in the target space  $G_2/SU(3)$  having dimension  $D = 6$  since  $SU(3)$  automorphisms leave given  $SU(3)$  invariant.
  - (b) This would allow to identify at each point of the string world sheet standard quaternionic basis - say in terms of complexified basis vectors consisting of two hyper-complex units and octonionic unit  $q_1$  with "color isospin"  $I_3 = 1/2$  and "color hypercharge"  $Y = -1/3$  and its conjugate  $\bar{q}_1$  with opposite color isospin and hypercharge.
  - (c) The  $CP_2$  point assigned with the quaternionic basis would correspond to the  $SU(3)$  rotation needed to rotate the standard basis to this basis and would actually correspond to the first row of  $SU(3)$  rotation matrix. Hyper-complex analyticity is the basic property of the solutions of the field equations representing Minkowskian string world sheets. Also now the same assumption is highly natural. In the case of string models in Minkowski space, the reduction of the induced metric to standard form implies Virasoro conditions and similar conditions are expected also now. There is no need to introduce action principle -just the hyper-complex analyticity is enough-since Kähler action already defines it.
3. The WZW model inspired approach to the situation would be following. The parametrization corresponds to a map  $g : X^2 \rightarrow G_2$  for which  $g$  defines a flat  $G_2$  connection at string world sheet. WZW type action would give rise to this kind of situation. The transition  $G_2 \rightarrow G_2/SU(3)$  would require that one gauges  $SU(3)$  degrees of freedom by bringing in  $SU(3)$  connection. Similar procedure for  $CP_2 = SU(3)/U(2)$  would bring in  $SU(3)$  valued chiral field and  $U(2)$  gauge field. Instead of introducing these connections one can simply introduce  $G_2/SU(3)$  and  $SU(3)/U(2)$  valued chiral fields. What this observation suggests that this ansatz indeed predicts gluons and electroweak gauge bosons assignable to string like objects so that the mathematical picture would be consistent with physical intuition.

### The two interpretations of $CP_2$

An old observation very relevant for what I have called  $M^8 - H$  duality [?] is that the moduli space of quaternionic sub-spaces of octonionic space (identifiable as  $M^8$ ) containing preferred hyper-complex plane is  $CP_2$ . Or equivalently, the space of two planes whose addition extends hyper-complex plane to some quaternionic subspace can be parametrized by  $CP_2$ . This  $CP_2$  can be called it  $CP_2^{mod}$  to avoid confusion. In the recent case this would mean that the space  $E^2(x) \subset E_x^2 \times T(CP_2)$  is represented by a point of  $CP_2^{mod}$ . On the other hand, the imbedding of space-time surface to  $H$  defines a point of "real"  $CP_2$ . This gives two different  $CP_2$ s.

1. The highly suggestive idea is that the identification  $CP_2^{mod} = CP_2$  (apart from isometry) is crucial for the construction of preferred extremals. Indeed, the projection of the space-time point to  $CP_2$  would fix the local polarization plane completely. This condition for  $E^2(x)$  would be purely local and depend on the values of  $CP_2$  coordinates only. Second condition for  $E^2(x)$  would involve the gradients of imbedding space coordinates including those of  $CP_2$  coordinates.
2. The conditions that the planes  $M_x^2$  form an integrable distribution at space-like level and that  $M_x^2$  is determined by the modified gamma matrices. The integrability of this distribution for  $M^4$  could imply the integrability for  $X^2$ .  $X^4$  would differ from  $M^4$  only by a deformation in degrees of freedom transversal to the string world sheets defined by the distribution of  $M^2$ s.

Does this mean that one can begin from vacuum extremal with constant values of  $CP_2$  coordinates and makes them non-constant but allows to depend only on transversal degrees of freedom? This condition is too strong even for simplest massless extremals for which  $CP_2$  coordinates depend on transversal coordinates defined by  $\epsilon \cdot m$  and  $\epsilon \cdot k$ . One could however allow dependence of  $CP_2$  coordinates on light-like  $M^4$  coordinate since the modification of the induced metric is light-like so that light-like coordinate remains light-like coordinate in this modification of the metric.

Therefore, if one generalizes directly what is known about massless extremals, the most general dependence of  $CP_2$  points on the light-like coordinates assignable to the distribution of  $M_x^2$  would be dependence on either of the light-like coordinates of Hamilton-Jacobi coordinates but not both.

### 2.8.2 What could be the construction recipe for the preferred extremals assuming $CP_2 = CP_2^{mod}$ identification?

The crucial condition is that the planes  $E^2(x)$  determined by the point of  $CP_2 = CP_2^{mod}$  identification and by the tangent space of  $E_x^2 \times CP_2$  are same. The challenge is to transform this condition to an explicit form.  $CP_2 = CP_2^{mod}$  identification should be general coordinate invariant. This requires that also the representation of  $E^2$  as  $(e^2, e^3)$  plane is general coordinate invariant suggesting that the use of preferred  $CP_2$  coordinates -presumably complex Eguchi-Hanson coordinates- could make life easy. Preferred coordinates are also suggested by number theoretical vision. A careful consideration of the situation would be required.

The modified gamma matrices define a quaternionic sub-space analogous to tangent space of  $X^4$  but not in general identical with the tangent space: this would be the case only if the action were 4-volume. I will use the notation  $T_x^m(X^4)$  about the modified tangent space and call the vectors of  $T_x^m(X^4)$  modified tangent vectors. I hope that this would not cause confusion.

#### $CP_2 = CP_2^{mod}$ condition

Quaternionic property of the counterpart of  $T_x^m(X^4)$  allows an explicit formulation using the tangent vectors of  $T_x^m(X^4)$ .

1. The unit vector pair  $(e_2, e_3)$  should correspond to a unique tangent vector of  $H$  defined by the coordinate differentials  $dh^k$  in some natural coordinates used. Complex Eguchi-Hanson coordinates [?] are a natural candidate for  $CP_2$  and require complexified octonionic imaginary units. If octonionic units correspond to the tangent vector basis of  $H$  uniquely, this is possible.
2. The pair  $(e_2, e_3)$  as also its complexification  $(q_1 = e_2 + ie_3, \bar{q}_1 = e_2 - ie_3)$  is expressible as a linear combination of octonionic units  $I_2, \dots, I_7$  should be mapped to a point of  $CP_2^{mod} = CP_2$  in canonical manner. This mapping is what should be expressed explicitly. One should express given  $(e_2, e_3)$  in terms of  $SU(3)$  rotation applied to a standard vector. After that one should define the corresponding  $CP_2$  point by the bundle projection  $SU(3) \rightarrow CP_2$ .
3. The tangent vector pair

$$(\partial_w h^k, \partial_{\bar{w}} h^k)$$

defines second representation of the tangent space of  $E^2(x)$ . This pair should be equivalent with the pair  $(q_1, \bar{q}_1)$ . Here one must be however very cautious with the choice of coordinates. If the choice of  $w$  is unique apart from constant the gradients should be unique. One can use also real coordinates  $(x, y)$  instead of  $(w = x + iy, \bar{w} = x - iy)$  and the pair  $(e_2, e_3)$ . One can project the tangent vector pair to the standard vielbein basis which must correspond to the octonion basis

$$(\partial_x h^k, \partial_y h^k) \rightarrow (\partial_x h^k e_k^A e_A, \partial_y h^k e_k^A e_A) \leftrightarrow (e_2, e_3) ,$$

where the  $e_A$  denote the octonion units in 1-1 correspondence with vielbein vectors. This expression can be compared to the expression of  $(e_2, e_3)$  derived from the knowledge of  $CP_2$  projection.

#### Formulation of quaternionicity condition in terms of octonionic structure constants

One can consider also a formulation of the quaternionic tangent planes in terms of  $(e_2, e_3)$  expressed in terms of octonionic units deducible from the condition that unit vectors obey quaternionic algebra. The expressions for octonionic *resp.* quaternionic structure constants can be found at [?] *resp.* [?].

1. The ansatz is

$$\begin{aligned} \{E_k\} &= \{1, I_1, E_2, E_3\} , \\ E_2 &= E_{2k}e^k \equiv \sum_{k=2}^7 E_{2k}e^k , \quad E_3 = E_{3k}e^k \equiv \sum_{k=2}^7 E_{3k}e^k , \\ |E_2| &= 1 , \quad |E_3| = 1 . \end{aligned} \tag{2.8.1}$$

2. The multiplication table for octonionic units expressible in terms of octonionic triangle [?] gives

$$f^{1kl}E_{2k} = E_{3l} , \quad f^{1kl}E_{3k} = -E_{2l} , \quad f^{klr}E_{2k}E_{3l} = \delta_1^r . \tag{2.8.2}$$

Here the indices are raised by unit metric so that there is no difference between lower and upper indices. Summation convention is assumed. Also the contribution of the real unit is present in the structure constants of third equation but this contribution must vanish.

3. The conditions are linear and quadratic in the coefficients  $E_{2k}$  and  $E_{3k}$  and are expected to allow an explicit solution. The first two conditions define homogenous equations which must allow solution. The coefficient matrix acting on  $(E_2, E_3)$  is of the form

$$\begin{pmatrix} f_1 & 1 \\ -1 & f_1 \end{pmatrix} ,$$

where 1 denotes unit matrix. The vanishing of the determinant of this matrix should be due to the highly symmetric properties of the structure constants. In fact the equations can be written as eigen conditions

$$f_1 \circ (E_2 \pm iE_3) = \mp i(E_2 \pm iE_3) ,$$

and one can say that the structure constants are eigenstates of the hermitian operator defined by  $I_1$  analogous to color hyper charge. Both values of color hyper charged are obtained.

### Explicit expression for the $CP_2 = CP_2^{mod}$ conditions

The symmetry under  $SU(3)$  allows to construct the solutions of the above equations directly.

1. One can introduce complexified basis of octonion units transforming like  $(1, 1, 3, \bar{3})$  under  $SU(3)$ . Note the analogy of triplet with color triplet of quarks. One can write complexified basis as  $(1, e_1, (q_1, q_2, q_3), (\bar{q}_1, \bar{q}_2, \bar{q}_3))$ . The expressions for complexified basis elements are

$$(q_1, q_2, q_3) = \frac{1}{\sqrt{2}}(e_2 + ie_3, e_4 + ie_5, e_6 + ie_7) .$$

These options can be seen to be possible by studying octonionic triangle in which all lines containing 3 units defined associative triple: any pair of octonion units at this kind of line can be used to form pair of complexified unit and its conjugate. In the tangent space of  $M^4 \times CP_2$  the basis vectors  $q_1$ , and  $q_2$  are mixtures of  $E_x^2$  and  $CP_2$  tangent vectors.  $q_3$  involves only  $CP_2$  tangent vectors and there is a temptation to interpret it as the analog of the quark having no color isospin.

2. The quaternionic basis is real and must transform like  $(1, 1, q_1, \bar{q}_1)$ , where  $q_1$  is any quark in the triplet and  $\bar{q}_1$  its conjugate in antitriplet. Having fixed some basis one can perform  $SU(3)$  rotations to get a new basis. The action of the rotation is by  $3 \times 3$  special unitary matrix. The over all phases of its rows do not matter since they induce only a rotation in  $(e_2, e_3)$  plane not

affecting the plane itself. The action of  $SU(3)$  on  $q_1$  is simply the action of its first row on  $(q_1, q_2, q_3)$  triplet:

$$\begin{aligned} q_1 &\rightarrow (Uq)_1 = U_{11}q_1 + U_{12}q_2 + U_{13}q_3 \equiv z_1q_1 + z_2q_2 + z_3q_3 \\ &= z_1(e_2 + ie_3) + z_2(e_4 + ie_5) + z_3(e_6 + ie_7) . \end{aligned} \quad (2.8.3)$$

The triplets  $(z_1, z_2, z_3)$  defining a complex unit vector and point of  $S^5$ . Since overall phase does not matter a point of  $CP_2$  is in question. The new real octonion units are given by the formulas

$$\begin{aligned} e_2 &\rightarrow Re(z_1)e_2 + Re(z_2)e_4 + Re(z_3)e_6 - Im(z_1)e_3 - Im(z_2)e_5 - Im(z_3)e_7 , \\ e_3 &\rightarrow Im(z_1)e_2 + Im(z_2)e_4 + Im(z_3)e_6 + Re(z_1)e_3 + Re(z_2)e_5 + Re(z_3)e_7 . \end{aligned} \quad (2.8.4)$$

For instance the  $CP_2$  coordinates corresponding to the coordinate patch  $(z_1, z_2, z_3)$  with  $z_3 \neq 0$  are obtained as  $(\xi_1, \xi_2) = (z_1/z_3, z_2/z_3)$ .

Using these expressions the equations expressing the conjecture  $CP_2 = CP_2^{mod}$  equivalence can be expressed explicitly as first order differential equations. The conditions state the equivalence

$$(e_2, e_3) \leftrightarrow (\partial_x h^k e_k^A e_A, \partial_y h^k e_k^A e_A) , \quad (2.8.5)$$

where  $e_A$  denote octonion units. The comparison of two pairs of vectors requires normalization of the tangent vectors on the right hand side to unit vectors so that one takes unit vector in the direction of the tangent vector. After this the vectors can be equated. This allows to express the contractions of the partial derivatives with vielbein vectors with the 6 components of  $e_2$  and  $e_3$ . Each condition gives 6+6 first order partial differential equations which are non-linear by the presence of the overall normalization factor for the right hand side. The equations are invariant under scalings of  $(x, y)$ . The very special form of these equations suggests that some symmetry is involved.

It must be emphasized that these equations make sense only in preferred coordinates: ordinary Minkowski coordinates and Hamiltonin-Jacobi coordinates for  $M^4$  and Eguchi-Hanson complex coordinates in which  $SU(2) \times U(1)$  is represented linearly for  $CP_2$ . These coordinates are preferred because they carry deep physical meaning.

### Does TGD boil down to two string models?

It is good to look what have we obtained. Besides Hamilton-Jacobi conditions, and  $CP_2 = CP_2^{mod}$  conditions one has what one might call string model with 6-dimensional  $G_2/SU(3)$  as tangent space. The orbit of string in  $G_2/SU(3)$  allows to deduce the  $G_2$  rotation identifiable as a point of  $G_2/SU(3)$  defining what one means with standard quaternionic plane at given point of string world sheet. The hypothesis is that hyper-complex analyticity solves these equations.

The conjectured electric-magnetic duality implies duality between string world sheet and partonic 2-surfaces central for the proposed mathematical applications of TGD [?, ?, ?, ?]. This duality suggests that the solutions to the  $CP_2 = CP_2^{mod}$  conditions could reduce to holomorphy with respect to the coordinate  $w$  for partonic 2-surface plus the analogs of Virasoro conditions. The dependence on light-like coordinate would appear as a parametric dependence.

If this were the case, TGD would reduce at least partially to what might be regarded as dual string models in  $G_2/SU(3)$  and  $SU(3)/U(2)$  and also to string model in  $M^4$  and  $X^4$ ! In the previous arguments one ends up to string models in moduli spaces of string world sheets and partonic 2-surfaces. TGD seems to yield an inflation of string models! This not actually surprising since the slicing of space-time sheets by string world sheets and partonic 2-surfaces implies automatically various kinds of maps having interpretation in terms of string orbits.

### 2.8.3 Could octonion analyticity solve the field equations?

The interesting question is what happens in the space-time regions with Euclidian signature of induced metric. In this case it is not possible to introduce light-like plane at each point of the space-time sheet. Nothing however prevents from applying the above described procedure to construct conserved currents whose flow lines define global coordinates. In both cases analytic continuation allows to extend the coordinates to complex coordinates. Therefore one would have two complex functions satisfying Laplace equation and having orthogonal gradients.

1. When  $CP_2$  projection is 4-dimensional, there is strong temptation to assume that these functions could be reduced to complex  $CP_2$  coordinates analogous to the Hamilton-Jacobi coordinates for  $M^4$ . Complex Eguchi-Hanson coordinates transforming linearly under  $U(2) \subset SU(3)$  define the simplest candidates in this respect. Laplace-equations are satisfied automatically since holomorphic functions are in question. The gradients are also orthogonal automatically since the metric is Kähler metric. Note however that one could argue that in inner product the conjugate of the function appears. Any holomorphic map defines new coordinates of this kind. Note that the maps need not be globally holomorphic since  $CP_2$  projection of space-time sheet need not cover the entire  $CP_2$ .
2. For string like objects  $X^4 = X^2 \times Y^2 \subset M^4 \times CP_2$  with Minkowskian signature of the metric the coordinate pair would be hyper-complex coordinate in  $M^4$  and complex coordinate in  $CP_2$ . If  $X^2$  has Euclidian signature of induced metric the coordinate in question would be complex coordinate. The proposal in the case of  $CP_2$  allows all holomorphic functions of the complex coordinates.

There is an objection against this construction. There should be a symmetry between  $M^4$  and  $CP_2$  but this is not the case. Therefore this picture cannot be quite correct.

Could the construction of new preferred coordinates by holomorphic maps generalize as electromagnetic duality suggests? One can imagine several options, which bring in mind old ideas that what I have christened as "romantic stuff" [K72].

1. Should one generalize the holomorphic map to a quaternion analytic map with real Taylor coefficients so that non-commutativity would not produce problems. One would map first  $M^4$  coordinates to quaternions, map these coordinates to new ones by quaternion analytic map defined by a Taylor or even Laurnte expansion with real coefficients, and then map the resulting quaternion valued coordinate back to hyper-quaternion defining four coordinates as fuctions in  $M^4$ . This procedure would be very much analogous to Wick rotation used in quantum field theories. Similar quaternion analytic map be applied also in  $CP_2$  degrees of freedom followed by the map of the quaternion to two complex numbers. This would give additional constraints on the map. This option could be seen as a quaternionic generalization of conformal invariance.

The problem is that one decouples  $M^4$  and  $CP_2$  degrees of freedom completely. These degrees are however coupled in the proposed construction since the  $E^2(x)$  corresponds to subspace of  $E_x^2 \times T(CP_2)$ . Something goes still wrong.

2. This motivates to imagine even more ambitious and even more romantic option realizing the original idea about octonionic generalization of conformal invariance. Assume linear  $M^4 \times CP_2$  coordinates (Eguchi-Hanson coordinates transforming linearly under  $U(2)$  in the case of  $CP_2$ ). Map these to octonionic coordinate  $h$ . Map the octonionic coordinate to itself by an octonionic analytic map defined by Taylor or even Laurent series with real coefficients so that non-commutativity and non-associativity do not cause troubles. Map the resulting octonion valued coordinates back to ordinary  $H$ -coordinates and expressible as functions of original coordinates.

It must be emphasized that this would be nothing but a generalization of Wick rotation and its inverse used routinely in quantum field theories in order to define loop integrals.

#### Could octonion real-analyticity make sense?

Suppose that one -for a fleeting moment- takes octonionic analyticity seriously. For space-time surfaces themselves one should have in some sense quaternionic variant of conformal invariance. What does this mean?

1. Could one regard space-time surfaces analogous to the curves at which the imaginary part of analytic function of complex argument vanishes so that complex analyticity reduces to real analyticity. One can indeed divide octonion to quaternion and its imaginary part to give  $o = q_1 + Iq_2$ :  $q_1$  and  $q_2$  are quaternions and  $I$  is octonionic imaginary unit in the complement of the quaternionic sub-space. This decomposition actually appears in the standard construction of octonions. Therefore 4-dimensional surfaces at which the imaginary part of octonion valued function vanishes make sense and defined in well-defined sense quaternionic 4-surfaces.

This kind of definition would be in nice accord with the vision about physics as algebraic geometry. Now the algebraic geometry would be extended from complex realm to the octonionic realm since quaternionic surfaces/string world sheets could be regarded as associative/commutative sub-algebras of the algebra of the octonionic real-analytic functions.

2. Could these surfaces correspond to quaternionic 4-surfaces defined in terms of the modified gamma matrices or induced gamma matrices? Contrary to the original expectations it will be found that only induced gamma matrices is a plausible option. This would be an enormous simplification and would mean that the theory is exactly solvable in the same sense as string models are: complex analyticity would be replaced with octonion analyticity. I have considered this option in several variants using the notion of real octonion analyticity [K72] but have not managed to build any satisfactory scenario.
3. Hyper-complex and complex conformal symmetries would result by a restriction to hyper-complex *resp.* complex sub-manifolds of the imbedding space defined by string world sheets *resp.* partonic 2-surfaces. The principle forcing this restriction would be commutativity. Yangian of an affine algebra would unify these views to single coherent view [?].

4-D n-point functions of the theory should result from the restriction on partonic 2-surfaces or string world sheets with arguments of n-point functions identified as the ends of braid strands so that a kind of analytic continuation from 2-D to the 4-D case would be in question. The octonionic conformal invariance would be induced by the ordinary conformal invariance in accordance with strong form of General Coordinate Invariance.

4. This algebraic continuation of the ordinary conformal invariance could help to construct also the representations of Yangians of affine Kac-Moody type algebras. For the Yangian symmetry of 1+1 D integrable QFTs the charges are multilocal involving multiple integrals over ordered multiple points of 1-D space. I

In the recent case multiple 1-D space is replaced with a space-like 3-surface at the light-like end of  $CD$ . The point of the 1-D space appearing in the multiple integral are replaced by a partonic 2-surface represented by a collection of punctures. There is a strong temptation to assume that the intermediate points on the line correspond to genuine physical particles and therefore to partonic 2-surfaces at which the signature of the induced metric changes. If so, the 1-D space would correspond to a closed curve connecting punctures of different partonic 2-surfaces representing physical particles and ordered along a loop. The integral over multiple points would correspond to an integral over WCW rather than over fixed back-ground space-time.

1-D space would be replaced with a closed curve going through punctures of a subset of partonic 2-surfaces associated with a space-like 3-surface. If a given partonic surface or a given puncture can contribute only once to the multiple integral the multi-locality is bounded from above and only a finite number of Yangian generators are obtained in this manner unless one allows the number of partonic 2-surfaces and of punctures for them to vary. This variation is physically natural and would correspond to generation of particle pairs by vacuum polarization. Although only punctures would contribute, the Yangian charges would be defined in WCW rather than in fixed space-time. Integral over positions of punctures and possible numbers of them would be actually an integral over WCW. 2-D modular invariance of Yangian charges for the partonic 2-surfaces is a natural constraint.

The question is whether some conformal fields at the punctures of the partonic 2-surfaces appearing in the multiple integral define the basic building bricks of the conserved quantum charges representing the multilocal generators of the Yangian algebra? Note that Wick rotation would be involved.

### What Wick rotation could mean?

Second definition of quaternionicity is on more shaky basis and motivated by the solutions of 2-D Laplace equation: quaternionic space-time surfaces would be obtained as zero loci of octonion real-analytic functions. Unfortunately octonion real-analyticity does not make sense in Minkowskian signature.

One could understand octonion real-analyticity in Minkowskian signature if one could understand the deeper meaning of Wick rotation. Octonion real analyticity formulated as a condition for the vanishing of the imaginary part of octonion real-analytic function makes sense for in octonionic coordinates for  $E^4 \times CP_2$  with Euclidian signature of metric.  $M^4 \times CP_2$  is however only a subspace of complexified octonions and not closed with respect to multiplication so that octonion real-analytic functions do not make sense in  $M^4 \times CP_2$ . Wick rotation should transform the solution candidate defined by an octonion real-analytic function to that defined in  $M^4 \times CP_2$ . A natural additional condition is that Wick rotation should reduce to that taking  $M^2 \subset M^4$  to  $E^2 \subset E^4$ .

The following trivial observation made in the construction of Hamilton-Jacobi structure in  $M^4$  with Minkowskian signature of the induced metric (see the appendix of [?]) as a Wick rotation of Hermitian structure in  $E^4$  might help here.

1. The components of the metric of  $E^2$  in complex coordinates  $(z, \bar{z})$  for  $E^2$  are given by  $g_{w\bar{w}} = -1$  whereas the metric of  $M^2$  in light-like coordinates  $(u = x+t, v = x-t)$  is given by  $g_{uv} = -1$ . The metric is same and  $M^2$  and  $E^2$  correspond only to different interpretations for the coordinates! One could say that  $M^4 \times CP_2$  and  $E^4 \times CP_2$  have same metric tensor, Kähler structure, and spinor structure. Since only these appear in field equations, one could hope that the solutions of field equations in  $M^4 \times CP_2$  and  $E^4 \times CP_2$  are obtained by Wick rotation. This for preferred extremals at least and if the field equations reduce to purely algebraic ones.
2. If one accepts the proposed construction of preferred extremals of Kähler action discussed in [?], the field equations indeed reduce to purely algebraic conditions satisfied if space-time surface possesses Hermitian structure in the case of Euclidian signature of the induced metric and Hamilton-Jacobi structure in the case of Minkowskian signature. Just as in the case of minimal surfaces, energy momentum tensor and second fundamental form have no common non-vanishing components. The algebraization requires as a consistency condition Einstein's equations with a cosmological term. Gravitational constant and cosmological constant follow as predictions.
3. If Wick rotation in the replacement of  $E^2$  coordinates  $(z, \bar{z})$  with  $M^2$  coordinates  $(u, v)$  makes sense, one can hope that field equations for the preferred extremals hold true also for a Wick rotated surfaces obtained by mapping  $M^2 \subset M^4$  to  $E^2 \subset E^4$ . Also Einstein's equations should be satisfied by the Wick rotated metric with Euclidian signature.
4. Wick rotation makes sense also for the surfaces defined by the vanishing of the imaginary part (complementary to quaternionic part) of octonion real-analytic function. Therefore one can hope that this ansatz could work. Wick rotation is non-trivial geometrically. For instance, light-like lines  $v = 0$  of hyper-complex plane  $M^2$  are taken to  $\bar{z} = 0$  defining a point of complex plane  $E^2$ . Note that non-invertible hyper-complex numbers correspond to the two light-like lines  $u = 0$  and  $v = 0$  whereas non-invertible complex numbers correspond to the origin of  $E^2$ .
5. If the conjecture holds true, one can apply to both factors in  $E^4 = E^2 \times E^2$  and to get preferred extremals in  $M^{2,2} \times CP_2$ . Minkowski space  $M^{2,2}$  is essential in twistor approach and the possibility to carry out Wick rotation for preferred extremals could justify Wick rotation in quantum theory.

### What the non-triviality of the moduli space of the octonionic structures means?

The moduli space  $G_2$  of the octonionic structures is essentially the Galois group defined as maps of octonions to itself respecting octonionic sum and multiplication. This raises the question whether octonion analyticity should be generalized in such a manner that the global choice of the octonionic imaginary units - in particular that of preferred commuting complex sub-space- would become local. Physically this would correspond to the choice of momentum plane  $M_x^2$  for a position dependent light-like momentum defining the plane of non-physical polarizations.



This question is inspired by the general solution ansatz based on the slicing of space-time sheets which involves the dependence of the choice of the momentum plane  $M_x^2$  on the point of string world sheet. This dependence is parameterized by a point of  $G_2/SU(3)$  and assumed to be constant along partonic 2-surfaces. These slicings would be naturally associated with the two complex parts  $c_i$  of the quaternionic coordinate  $q_1 = c_1 + Ic_2$  of the space-time sheet.

This dependence is well-defined only for the quaternionic 4-surface defining the space-time surface and can be seen as a local choice of a preferred complex imaginary unit along string world sheets.  $CP_2$  would parametrize the remaining geometric degrees of freedom. Should/could one extend this dependence to entire 8-D imbedding space? This is possible if the 8-D imbedding space allows a slicing by the string world sheets. If the string world sheets correspond to the string world sheets appearing in the slicing of  $M^4$  defined by Hamilton-Jacobi coordinates [K9], this slicing indeed exists.

### Zero energy ontology and octonion analyticity

How does this picture relate to zero energy ontology and how partonic 2-surfaces and string world sheets could be identified in this framework?

1. The intersection of the quaternionic four-surfaces with the 7-D light-like boundaries of  $CD$ s is 3-D space-like surface. String world sheets are obtained as 2-D complex surfaces by putting  $c_2 = 0$ , where  $c_2$  is the imaginary part of the quaternion coordinate  $q = c_1 + Ic_2$ . Their intersections with  $CD$  boundaries are generally 1-dimensional and represent space-like strings.
2. Partonic 2-surfaces could correspond to the intersections of  $Re(c_1) = constant$  3-surfaces with the boundaries of  $CD$ . The variation of  $Re(c_1)$  would give a family of (possibly light-like) 3-surfaces whose intersection with the boundaries of  $CD$  would be 2-dimensional. The interpretation  $Re(c_1) = constant$  surfaces as (possibly light-like) orbits of partonic 2-surfaces would be natural. Wormhole throats at which the signature of the induced metric changes (by definition) would correspond to some special value of  $Re(c_1)$ , naturally  $Re(c_1) = 0$ .

What comes first in mind is that partonic 2-surfaces assignable to wormhole throats correspond to co-complex 2-surfaces obtained by putting  $c_1 = 0$  (or  $c_1 = constant$ ) in the decomposition  $q = c_1 + ic_2$ . This option is consistent with the above assumption if  $Im(c_1) = 0$  holds true at the boundaries of  $CD$ . Note that also co-quaternionic surfaces make sense and would have Euclidian signature of the induced metric: the interpretation as counterparts of lines of generalized Feynman graphs might make sense.

3. One can of course wonder whether also the poles of  $c_1$  might be relevant. The most natural idea is that the value of  $Re(c_1)$  varies between 0 and  $\infty$  between the ends of the orbit of partonic 2-surface. This would mean that  $c_1$  has a pole at the other end of  $CD$  (or light-like orbit of partonic 2-surface). In light of this the earlier proposal [?] that zero energy states might correspond to rational functions assignable to infinite primes and that the zeros/poles of these functions correspond to the positive/negative energy part of the state is interesting.

The intersections of string world sheets and partonic 2-surfaces identifiable as the common ends of space-like and time like braid strands would correspond to the points  $q = c_1 + Ic_2 = 0$  and  $q = \infty + Ic_2$ , where  $\infty$  means real infinity. In other words, to the zeros and real poles of quaternion analytic function with real coefficients. In the number theoretic vision especially interesting situations correspond to polynomials with rational number valued coefficients and rational functions formed from these. In this kind of situations the number of zeros and therefore of braid strands is always finite.

### Do induced or modified gamma matrices define quaternionicity?

There are two options to be considered: either induced or modified gamma matrices define quaternionicity.

1. There are several arguments supporting this view that induced gamma matrices define quaternionicity and that quaternionic planes are therefore tangent planes for space-time sheet.

- (a)  $H - M^8$  correspondence is based on the observation that quaternionic sub-spaces of octonions containing preferred complex sub-space are labelled by points of  $CP_2$ . The integrability of the distribution of quaternionic spaces could follow from the parametrization by points of  $CP_2$  ( $CP_2 = CP_{mod}$  condition). Quaternionic planes would be necessarily tangent planes of space-time surface. Induced gamma matrices correspond naturally to the tangent space vectors of the space-time surface.

Here one should however understand the role of the  $M^4$  coordinates. What is the functional form of  $M^4$  coordinates as functions of space-time coordinates or does this matter at all (general coordinate invariance): could one choose the space-time coordinates as  $M^4$  coordinates for surfaces representable as graphs for maps  $M^4 \rightarrow CP_2$ ? What about other cases such as cosmic strings [K18]?

- (b) Could one do entirely without gamma matrices and speak only about induced octonion structure in 8-D tangent space (raising also dimension  $D = 8$  to preferred role) with reduces to quaternionic structure for quaternionic 4-surfaces. The interpretation of quaternionic plane as tangent space would be unavoidable also now. In this approach there would be no question about whether one should identify octonionic gamma matrices as induced gamma matrices or as modified octonionic gamma matrices.
- (c) If quaternion analyticity is defined in terms of modified gamma matrices defined by the volume action why it would solve the field equations for Kähler action rather than for minimal surfaces? Is the reason that quaternionic and octonionic analyticities defined as generalized differentiability are not possible. The real and imaginary parts of quaternionic real-analytic function with quaternion interpreted as bi-complex number are not analytic functions of two complex variables of either complex variable. In 4-D situation minimal surface property would be too strong a condition whereas Kähler action poses much weaker conditions. Octonionic real-analyticity however poses strong symmetries and suggests effective 2-dimensionality.

2. The following argument suggest that modified gamma matrices cannot define the notion of quaternionic plane.

- (a) Modified gamma matrices can define sub-spaces of lower dimensionality so that they do not defined a 4-plane. In this case they cannot define  $CP_2$  point so that  $CP_2 = CP_2^{mod}$  identity fails. Massless extremals represents the basic example about this. Hydrodynamic solutions defined in terms of Beltrami flows could represent a more general phase of this kind.
- (b) Modified gamma matrices are not in general parallel to the space-time surface. The  $CP_2$  part of field equations coming from the variation of Kähler form gives the non-tangential contribution. If the distribution of the quaternionic planes is integrable it defines another space-time surface and this looks rather strange.
- (c) Integrable quaternionicity can mean only tangent space quaternionicity. For modified gamma matrices this cannot be the case. One cannot assign to the octonion analytic map modified gamma matrices in any natural manner.

The conclusion seems to be that induced gamma matrices or induced octonion structure must define quaternionicity and quaternionic planes are tangent planes of space-time surface and therefore define an integrable distribution. An open question is whether  $CP_2 = CP_2^{mod}$  condition implies the integrability automatically.

### Volume action or Kähler action?

What seems clear is that quaternionicity must be defined by the induced gamma matrices obtained as contractions of canonical momentum densities associated with volume action with imbedding space gamma matrices. Probably equivalent definition is in terms of induced octonion structure. For the believer in strings this would suggest that the volume action is the correct choice. There are however strong objections against this choice.

1. In 2-dimensional case the minimal surfaces allow conformal invariance and one can speak of complex structure in their tangent space. In particular, string world sheets can be regarded as complex 2-surfaces of quaternionic space-time surfaces. In 4-dimensional case the situation is different since quaternionic differentiability fails by non-commutativity. It is quite possible that only very few minimal surfaces (volume action) are quaternionic.
2. The possibility of Beltrami flows is a rather plausible property of quite many preferred extremals of Kähler action. Beltrami flows are also possible for a 4-D minimal surface action. In particular,  $M^4$  translations would define Beltrami flows for which the 1-forms would be gradients of linear  $M^4$  coordinates. If  $M^4$  coordinate can be used one obtains flows in directions of all coordinate axes. Hydrodynamical picture in the strong form therefore fails whereas for Kähler action various isometry currents could be parallel (as they are for massless extremals).
3. For volume action topological QFT property fails as also fails the decomposition of solutions to massless quanta in Minkowskian regions. The same applies to criticality. The crucial vacuum degeneracy responsible for most nice features of Kähler action is absent and also the effective 2-dimensionality and almost topological QFT property are lost since the action does not reduce to 3-D term.

One can however keep Kähler action and define quaternionicity in terms of induced gamma matrices or induced octonion structure. Preferred extremals could be identified as extremals of Kähler action which are also quaternionic 4-surfaces.

1. Preferred extremal property for Kähler action could be much weaker condition than minimal surface property so that much larger set of quaternionic space-time surfaces would be extremals of the Kähler action than of volume action. The reason would be that the rank of energy momentum tensor for Maxwell action tends to be smaller than maximal. This expectation is supported by the vacuum degeneracy, the properties of massless extremals and of  $CP_2$  type vacuum extremals, and by the general hydrodynamical picture.
2. There is also a long list of beautiful properties supporting Kähler action which should be also familiar: effective 2-dimensionality and slicing of space-time surface by string world sheets and partonic 2-surfaces, reduction to almost topological QFT and to abelian Chern-Simons term, weak form of electric-magnetic duality, quantum criticality, spin glass degeneracy, etc...

### **Are quaternionicities defined in terms of induced gamma matrices *resp.* octonion real-analytic maps equivalent?**

Quaternionicity could be defined by induced gamma matrices or in terms of octonion real-analytic maps. Are these two definitions equivalent and how could one test the equivalence?

1. The calculation technical problem is that space-time surfaces are not defined in terms of imbedding map involving some coordinate choice but in terms of four vanishing conditions for the imaginary part of the octonion real-analytic function expressible as biquaternion valued functions.
2. Integrability to 4-D surface is achieved if there exists a 4-D closed Lie algebra defined by vector fields identifiable as tangent vector fields. This Lie algebra can be generalized to a local 4-D Lie algebra. One cannot however represent octonionic units in terms of 8-D vector fields since the commutators of the latter do not form an associative algebra. Also the representation of 7 octonionic imaginary units as 8-D vector fields is impossible since the algebra in question is non-associative Malcev algebra [?] which can be seen as a Lie algebra over non-associative number field (one speaks of 7-dimensional cross product [?]). One must use instead of vector fields either octonionic units as such or octonionic gamma "matrices" to represent tangent vectors. The use of octonionic units as such would mean the introduction of the notion of octonionic tangent space structure. That the subalgebra generated by any two octonionic units is associative brings strongly in mind effective 2-dimensionality.

3. The tangent vector fields of space-time surface in the representation using octonionic units can be identified in the following manner. Map can be defined using 8-D octonionic coordinates defined by standard  $M^4$  coordinates or possibly Hamilton-Jacobi coordinates and  $CP_2$  complex coordinates for which  $U(2)$  is represented linearly. Gamma "matrices" for  $H$  using octonionic representation are known in these coordinates. One can introduce the 8 components of the image of a given point under the octonion real-analytic map as new imbedding space coordinates. One can calculate the covariant gamma matrices of  $H$  in these coordinates.

What should check whether the octonionic gamma matrices associated with the four non-vanishing coordinates define quaternionic (and thus associative) algebra in the octonionic basis for the gamma matrices. Also the interpretation as a associative subspace of local Malcev algebra elements is possible and one should check whether if the algebra reduces to a quaternionic Lie-algebra. Local  $SO(2) \times U(1)$  algebra should emerge in this manner.

4. Can one identify quaternionic imaginary units with vector fields generating  $SO(3)$  Lie algebra or its local variant? The Lie algebra of rotation generators defines algebra equivalent with that based on commutators of quaternionic units. Could the slicing of space-time sheet by time axis define local  $SO(3)$  algebra? Light-like momentum direction and momentum direction and its dual define as their sum space-like vector field and together with vector fields defining transversal momentum directions they might generate a local  $SO(3)$  algebra.

### Questions related to quaternion real-analyticity

There are many poorly understood issues and the following questions represent only some of very many such questions picked up rather randomly.

1. The above considerations are restricted to Minkowskian regions of space-time sheets. What happens in the Euclidian regions? Does the existence of light-like Beltrami field and its dual generalize to the existence of complex vector field and its dual?
2. It would be nice to find a justification for the notion of  $CD$  from basic principles. The condition  $q\bar{q} = 0$  implies  $q = 0$  for quaternions. For hyper-quaternionic subspace of complexified quaternions obtained by Wick rotation it implies  $q\bar{q} = 0$  corresponds the entire light-cone boundary. If n-point functions can be identified identified as products of quaternion valued n-point functions and their quaternionic conjugates, the outcome could be proportional to  $1/q\bar{q}$  having poles at light-cone boundaries or  $CD$  boundaries rather than at single point as in Euclidian realm.
3. This correspondence of points and light-cone boundaries would effectively identify the points at future and past light-like boundaries of  $CD$  along light rays. Could one think that only the 2-sphere at which the upper and lower light-like boundaries of  $CD$  meet remains after this identification. The structure would be homologically very much like  $CP_2$  which is obtained by compactifying  $E^4$  by adding a 2-sphere at infinity. Could this  $CD - CP_2$  correspondence have some deep physical meaning? Do the boundaries of  $CD$  somehow correspond to zeros and/or poles of quaternionic analytic functions in the Minkowskian realm? Could the light-like orbits of partonic 2-surfaces at which the signature of the induced metric changes correspond to similar counterparts of zeros or poles when the quaternion analytic variables is obtained as quaternion real analytic function of  $H$  coordinates regarded as bi-quaternions?
4. Could braids correspond to zeros and poles of an octonion real-analytic function? Consider the partonic 2-surfaces at which the signature of the induced metric changes. The intersections of these surfaces with string world sheets at the ends of  $CDs$ . contain only complex and thus commutative points meaning that the imaginary part of bi-complex number representing quaternionic value of octonion real-analytic function vanishes. Braid ends would thus correspond to the origins of local complex coordinate patches. Finite measurement resolution would be forced by commutativity condition and correlate directly with the complexity of the partonic 2-surface measured by the minimal number of coordinate patches. Its realization would be as an upper bound on the number of braid strands. A natural expectation would be that only the values of n-point functions at these points contribute to scattering amplitudes. Number theoretic braids would be realized but in a manner different from the original guess.

### How complex analysis could generalize?

One can make several questions related to the possible generalization of complex analysis to the quaternionic and octonionic situation.

1. Does the notion of analyticity in the sense that derivatives  $df/dq$  and  $df/do$  make sense hold true? The answer is "No": non-commutativity destroys all hopes about this kind of generalization. Octonion and quaternion real-analyticity has however a well-defined meaning.
2. Could the generalization of residue calculus by keeping interaction contours as 1-D curves make sense? Since residue formulas is the outcome of the fact that any analytic function  $g$  can be written as  $g = df/dz$  locally, the answer is "No".
3. Could one generalize of the residue calculus by replacing 1-dimensional curves with 4-D surfaces -possibly quaternionic 4-surfaces? Could one reduce the 4-D integral of quaternion analytic function to a double residue integral? This would be the case if the quaternion real-analytic function of  $q = c_1 + Ic_2$  could be regarded as an analytic function of complex arguments  $c_1$  and  $c_2$ . This is not the case. The product of two octonions decomposed to two quaternions as  $o_i = q_{i1} + Iq_{i2}$ ,  $i = a, b$  reads as

$$o_a o_b = q_{a1} q_{b1} - \bar{q}_{a2} q_{b2} + I(\bar{q}_{a1} q_{b2} - q_{a2} q_{b1}) . \quad (2.8.6)$$

The conjugations result from the anticommutativity of imaginary parts and  $I$ . This formula gives similar formula for quaternions by restriction. As a special cas  $o_a = o_b = q_1 + Iq_2$  one has

$$o^2 = q_1^2 - \bar{q}_2 q_2 + I(\bar{q}_1 q_2 - q_2 q_1)$$

From this it is clear that the real part of an octonion real-analytic function cannot be regarded as quaternion-analytic function unless one assumes that the imaginary part  $q_2$  vanishes. By similar argument real part of quaternion real-analytic function  $q = c_1 + Ic_2$  fails to be analytic unless one restricts the consideration to a surface at which one has  $c_2 = 0$ . These negative results are obviously consistent with the effective 2-dimensionality.

4. One must however notice that physicists use often what might be called analytization trick [?] working if the non-analytic function  $f(x, y) = f(z, \bar{z})$  is differentiable. The trick is to interpret  $z$  and  $\bar{z}$  as independent variables. In the recent case this is rather natural. Wick rotation could be used to transform the integral over the space-time sheet to integral in quaternionic domain. For 4-dimensional integrals of quaternion real-analytic function with integration measure proportional to  $dc_1 d\bar{c}_1 dc_2 d\bar{c}_2$  one could formally define the integral using multiple residue integration with four complex variables. The constraint is that the poles associated with  $c_i$  and  $\bar{c}_i$  are conjugates of each other. Quaternion real-analyticity should guarantee this. This would of course be a *definition* of four-dimensional integral and might work for the 4-D generalization of conformal field theory.

Mandelbrot and Julia sets are fascinating fractals and already now more or less a standard piece of complex analysis. The fact that the iteration of octonion real-analytic map produces a sequence of space-time surfaces and partonic 2-surfaces encourages to ask whether these notions -and more generally, the dynamics based on iteration of analytic functions - might have a higher-dimensional generalization in the proposed framework.

1. The canonical Mandelbrot set corresponds to the set of the complex parameters  $c$  in  $f(z) = z^2 + c$  for which iterates of  $z = 0$  remain finite. In octonionic and quaternionic real-analytic case  $c$  would be real so that one would obtain only the intersection of the Mandelbrot set with real axes and the outcome would be rather uninteresting. This is true quite generally.

2. Julia set corresponds to the boundary of the Fatou set in which the dynamics defined by the iteration of  $f(z)$  by definition behaves in a regular manner. In Julia set the behavior is chaotic. Julia set can be defined as a set of complex plane resulting by taking inverse images of a generic point belonging to the Julia set. For polynomials Julia set is the boundary of the region in which iterates remain finite. In Julia set the dynamics defined by the iteration is chaotic.

Julia set could be interesting also in the recent case since it could make sense for real analytic functions of both quaternions and octonions, and one might hope that the dynamics determined by the iterations of octonion real-analytic function could have a physical meaning as a space-time correlate for quantal self-organization by quantum jump in TGD framework. Single step in iteration would be indeed a very natural space-time correlate for quantum jump. The restriction of octonion analytic functions to string world sheets should produce the counterparts of the ordinary Julia sets since these surfaces are mapped to themselves under iteration and octonion real-analytic functions reduces to ordinary complex real-analytic functions at them. Therefore one might obtain the counterparts of Julia sets in 4-D sense as extensions of ordinary Julia sets. These extensions would be 3-D sets obtained as piles of ordinary Julia sets labelled by partonic 2-surfaces.

## 2.9 In what sense TGD could be an integrable theory?

During years evidence supporting the idea that TGD could be an integrable theory in some sense has accumulated. The challenge is to show that various ideas about what integrability means form pieces of a bigger coherent picture. Of course, some of the ideas are doomed to be only partially correct or simply wrong. Since it is not possible to know beforehand what ideas are wrong and what are right the situation is very much like in experimental physics and it is easy to claim (and has been and will be claimed) that all this argumentation is useless speculation. This is the price that must be paid for real thinking.

Integrable theories allow to solve nonlinear classical dynamics in terms of scattering data for a linear system. In TGD framework this translates to quantum classical correspondence. The solutions of modified Dirac equation define the scattering data. This data should define a real analytic function whose octonionic extension defines the space-time surface as a surface for which its imaginary part in the representation as bi-quaternion vanishes. There are excellent hopes about this thanks to the reduction of the modified Dirac equation to geometric optics.

In the following I will first discuss briefly what integrability means in (quantum) field theories, list some bits of evidence for integrability in TGD framework, discuss once again the question whether the different pieces of evidence are consistent with other and what one really means with various notions. As an outcome I represent what I regard as a more coherent view about integrability of TGD. The notion of octonion analyticity developed in the previous section is essential for the for what follows.

### 2.9.1 What integrable theories are?

The following is an attempt to get some bird's eye of view about the landscape of integrable theories.

#### Examples of integrable theories

Integrable theories are typically non-linear 1+1-dimensional (quantum) field theories. Solitons and various other particle like structures are the characteristic phenomenon in these theories. Scattering matrix is trivial in the sense that the particles go through each other in the scattering and suffer only a phase change. In particular, momenta are conserved. Korteweg-de Vries equation [?] was motivated by the attempt to explain the experimentally discovered shallow water wave preserving its shape and moving with a constant velocity. Sine-Gordon equation [?] describes geometrically constant curvature surfaces and defines a Lorentz invariant non-linear field theory in 1+1-dimensional space-time, which can be applied to Josephson junctions (in TGD inspired quantum biology it is encountered in the model of nerve pulse [K55]). Non-linear Schrödinger equation [?] having applications to optics and water waves represents a further example. All these equations have various variants.

From TGD point of view conformal field theories represent an especially interesting example of integrable theories. (Super-)conformal invariance is the basic underlying symmetry and by its infinite-

dimensional character implies infinite number of conserved quantities. The construction of the theory reduces to the construction of the representations of (super-)conformal algebra. One can solve 2-point functions exactly and characterize them in terms of (possibly anomalous) scaling dimensions of conformal fields involved and the coefficients appearing in 3-point functions can be solved in terms of fusion rules leading to an associative algebra for conformal fields. The basic applications are to 2-dimensional critical thermodynamical systems whose scaling invariance generalizes to conformal invariance. String models represent second application in which a collection of super-conformal field theories associated with various genera of 2-surface is needed to describe loop corrections to the scattering amplitudes. Also moduli spaces of conformal equivalence classes become important.

Topological quantum field theories are also examples of integrable theories. Because of its independence on the metric Chern-Simons action is in 3-D case the unique action defining a topological quantum field theory. The calculations of knot invariants (for TGD approach see [?]), topological invariants of 3-manifolds and 4-manifolds, and topological quantum computation (for a model of DNA as topological quantum computer see [K24]) represent applications of this approach. TGD as almost topological QFT means that the Kähler action for preferred extremals reduces to a surface term by the vanishing of Coulomb term in action and by the weak form of electric-magnetic duality reduces to Chern-Simons action. Both Euclidian and Minkowskian regions give this kind of contribution.

$\mathcal{N} = 4$  SYM is the a four-dimensional and very nearly realistic candidate for an integral quantum field theory. The observation that twistor amplitudes allow also a dual of the 4-D conformal symmetry motivates the extension of this symmetry to its infinite-dimensional Yangian variant [?]. Also the enormous progress in the construction of scattering amplitudes suggests integrability. In TGD framework Yangian symmetry would emerge naturally by extending the symplectic variant of Kac-Moody algebra from light-cone boundary to the interior of causal diamond and the Kac-Moody algebra from light-like 3-surface representing wormhole throats at which the signature of the induced metric changes to the space-time interior [?].

### About mathematical methods

The mathematical methods used in integrable theories are rather refined and have contributed to the development of the modern mathematical physics. Mention only quantum groups, conformal algebras, and Yangian algebras.

The basic element of integrability is the possibility to transform the non-linear classical problem for which the interaction is characterized by a potential function or its analog to a linear scattering problem depending on time. For instance, for the ordinary Schrödinger function one can solve potential once single solution of the equation is known. This does not work in practice. One can however gather information about the asymptotic states in scattering to deduce the potential. One cannot do without information about bound state energies too.

In TGD framework asymptotic states correspond to partonic 2-surfaces at the two light-like boundaries of  $CD$  (more precisely: the largest  $CD$  involved and defining the IR resolution for momenta). From the scattering data coding information about scattering for various values of energy of the incoming particle one deduced the potential function or its analog.

1. The basic tool is inverse scattering transform known as Gelfand-Marchenko-Levitan (GML) transform described in simple terms in [?].
  - (a) In 1+1 dimensional case the S-matrix characterizing scattering is very simple since the only thing that can take place in scattering is reflection or transmission. Therefore the S-matrix elements describe either of these processes and by unitarity the sum of corresponding probabilities equals to 1. The particle can arrive to the potential either from left or right and is characterized by a momentum. The transmission coefficient can have a pole meaning complex (imaginary in the simplest case) wave vector serving as a signal for the formation of a bound state or resonance. The scattering data are represented by the reflection and transmission coefficients as function of time.
  - (b) One can deduce an integral equation for a propagator like function  $K(t, x)$  describing how delta pulse moving with light velocity is scattered from the potential and is expressible in terms of time integral over scattering data with contributions from both scattering states and bound states. The derivation of GML transform [?] uses time reversal and time

translational invariance and causality defined in terms of light velocity. After some tricks one obtains the integral equation as well as an expression for the time independent potential as  $V(x) = K(x, x)$ . The argument can be generalized to more complex problems to deduce the GML transform.

2. The so called Lax pair is one manner to describe integrable systems [?]. Lax pair consists of two operators  $L$  and  $M$ . One studies what might be identified as "energy" eigenstates satisfying  $L(x, t)\Psi = \lambda\Psi$ .  $\lambda$  does not depend on time and one can say that the dynamics is associated with  $x$  coordinate whereas as  $t$  is time coordinate parametrizing different variants of eigenvalue problem with the same spectrum for  $L$ . The operator  $M(t)$  does not depend on  $x$  at all and the independence of  $\lambda$  on time implies the condition

$$\partial_t L = [L, M] \ .$$

This equation is analogous to a quantum mechanical evolution equation for an operator induced by time dependent "Hamiltonian"  $M$  and gives the non-linear classical evolution equation when the commutator on the right hand side is a multiplicative operator (so that it does not involve differential operators acting on the coordinate  $x$ ). Non-linear classical dynamics for the time dependent potential emerges as an integrability condition.

One could say that  $M(t)$  introduces the time evolution of  $L(t, x)$  as an automorphism which depends on time and therefore does not affect the spectrum. One has  $L(t, x) = U(t)L(0, x)U^{-1}(t)$  with  $dU(t)/dt = M(t)U(t)$ . The time evolution of the analog of the quantum state is given by a similar equation.

3. A more refined view about Lax pair is based on the observation that the above equation can be generalized so that  $M$  depends also on  $x$ . The generalization of the basic equation for  $M(x, t)$  reads as

$$\partial_t L - \partial_x M - [L, M] = 0 \ .$$

The condition has interpretation as a vanishing of the curvature of a gauge potential having components  $A_x = L, A_t = M$ . This generalization allows a beautiful geometric formulation of the integrability conditions and extends the applicability of the inverse scattering transform. The monodromy of the flat connection becomes important in this approach. Flat connections in moduli spaces are indeed important in topological quantum field theories and in conformal field theories.

4. There is also a connection with the so called Riemann-Hilbert problem [?]. The monodromies of the flat connection define monodromy group and Riemann-Hilbert problem concerns the existence of linear differential equations having a given monodromy group. Monodromy group emerges in the analytic continuation of an analytic function and the action of the element of the monodromy group tells what happens for the resulting many-valued analytic function as one turns around a singularity once ('mono-'). The linear equations obviously relate to the linear scattering problem. The flat connection  $(M, L)$  in turn defines the monodromy group. What is needed is that the functions involved are analytic functions of  $(t, x)$  replaced with a complex or hyper-complex variable. Again Wick rotation is involved. Similar approach generalizes also to higher dimensional moduli spaces with complex structures.

In TGD framework the effective 2-dimensionality raises the hope that this kind of mathematical apparatus could be used. An interesting possibility is that finite measurement resolution could be realized in terms of a gauge group or Kac-Moody type group represented by trivial gauge potential defining a monodromy group for n-point functions. Monodromy invariance would hold for the full n-point functions constructed in terms of analytic n-point functions and their conjugates. The ends of braid strands are natural candidates for the singularities around which monodromies are defined.



### 2.9.2 Why TGD could be integrable theory in some sense?

There are many indications that TGD could be an integrable theory in some sense. The challenge is to see which ideas are consistent with each other and to build a coherent picture where everything finds its own place.

1. 2-dimensionality or at least effective 2-dimensionality seems to be a prerequisite for integrability. Effective 2-dimensionality is suggested by the strong form of General Coordinate Invariance implying also holography and generalized conformal invariance predicting infinite number of conservation laws. The dual roles of partonic 2-surfaces and string world sheets supports a four-dimensional generalization of conformal invariance. Twistor considerations [?] indeed suggest that Yangian invariance and Kac-Moody invariances combine to a 4-D analog of conformal invariance induced by 2-dimensional one by algebraic continuation.
2. Octonionic representation of imbedding space Clifford algebra and the identification of the space-time surfaces as quaternionic space-time surfaces would define a number theoretically natural generalization of conformal invariance. The reason for using gamma matrix representation is that vector field representation for octonionic units does not exist. The problem concerns the precise meaning of the octonionic representation of gamma matrices.

Space-time surfaces could be quaternionic also in the sense that conformal invariance is analytically continued from string curve to 8-D space by octonion real-analyticity. The question is whether the Clifford algebra based notion of tangent space quaternionicity is equivalent with octonionic real-analyticity based notion of quaternionicity.

The notions of co-associativity and co-quaternionicity make also sense and one must consider seriously the possibility that associativity-co-associativity dichotomy corresponds to Minkowskian-Euclidian dichotomy.

3. Field equations define hydrodynamic Beltrami flows satisfying integrability conditions of form  $J \wedge dJ = 0$ .
  - (a) One can assign local momentum and polarization directions to the preferred extremals and this gives a decomposition of Minkowskian space-time regions to massless quanta analogous to the 1+1-dimensional decomposition to solitons. The linear superposition of modes with 4-momenta with different directions possible for free Maxwell action does not look plausible for the preferred extremals of Kähler action. This rather quantal and solitonic character is in accordance with the quantum classical correspondence giving very concrete connection between quantal and classical particle pictures. For 4-D volume action one does not obtain this kind of decomposition. In 2-D case volume action gives superposition of solutions with different polarization directions so that the situation is nearer to that for free Maxwell action and is not like soliton decomposition.
  - (b) Beltrami property in strong sense allows to identify 4 preferred coordinates for the space-time surface in terms of corresponding Beltrami flows. This is possible also in Euclidian regions using two complex coordinates instead of hyper-complex coordinate and complex coordinate. The assumption that isometry currents are parallel to the same light-like Beltrami flow implies hydrodynamic character of the field equations in the sense that one can say that each flow line is analogous to particle carrying some quantum numbers. This property is not true for all extremals (say cosmic strings).
  - (c) The tangent bundle theoretic view about integrability is that one can find a Lie algebra of vector fields in some manifold spanning the tangent space of a lower-dimensional manifolds and is expressed in terms of Frobenius theorem [?]. The gradients of scalar functions defining Beltrami flows appearing in the ansatz for preferred extremals would define these vector fields and the slicing. Partonic 2-surfaces would correspond to two complex conjugate vector fields (local polarization direction) and string world sheets to light-like vector field and its dual (light-like momentum directions). This slicing generalizes to the Euclidian regions.
4. Infinite number of conservation laws is the signature of integrability. Classical field equations follow from the condition that the vector field defined by modified gamma matrices has vanishing

divergence and can be identified an integrability condition for the modified Dirac equation guaranteeing also the conservation of super currents so that one obtains an infinite number of conserved charges.

5. Quantum criticality is a further signal of integrability. 2-D conformal field theories describe critical systems so that the natural guess is that quantum criticality in TGD framework relates to the generalization of conformal invariance and to integrability. Quantum criticality implies that Kähler coupling strength is analogous to critical temperature. This condition does affect classical field equations only via boundary conditions expressed as weak form of electric magnetic duality at the wormhole throats at which the signature of the metric changes.

For finite-dimensional systems the vanishing of the determinant of the matrix defined by the second derivatives of potential is similar signature and applies in catastrophe theory. Therefore the existence of vanishing second variations of Kähler action should characterize criticality and define a property of preferred extremals. The vanishing of second variations indeed leads to an infinite number of conserved currents [?, K9].

### 2.9.3 Questions

There are several questions which are not completely settled yet. Even the question what preferred extremals are is still partially open. In the following I try to de-learn what I have possibly learned during these years and start from scratch to see which assumptions might be un-necessarily strong or even wrong.

### 2.9.4 Could TGD be an integrable theory?

Consider first the abstraction of integrability in TGD framework. Quantum classical correspondence could be seen as a correspondence between linear quantum dynamics and non-linear classical dynamics. Integrability would realize this correspondence. In integrable models such as Sine-Gordon equation particle interactions are described by potential in 1+1 dimensions. This too primitive for the purposes of TGD. The vertices of generalized Feynman diagrams take care of this. At lines one has free particle dynamics so that the situation could be much simpler than in integrable models if one restricts the considerations to the lines or Minkowskian space-time regions surrounding them.

The non-linear dynamics for the space-time sheets representing incoming lines of generalized Feynman diagram should be obtainable from the linear dynamics for the induced spinor fields defined by modified Dirac operator. There are two options.

1. Strong form of the quantum classical correspondence states that each solution for the linear dynamics of spinor fields corresponds to space-time sheet. This is analogous to solving the potential function in terms of a single solution of Schrödinger equation. Coupling of space-time geometry to quantum numbers via measurement interaction term is a proposal for realizing this option. It is however the quantum numbers of positive/negative energy parts of zero energy state which would be visible in the classical dynamics rather than those of induced spinor field modes.
2. Only overall dynamics characterized by scattering data- the counterpart of  $S$ -matrix for the modified Dirac operator- is mapped to the geometry of the space-time sheet. This is much more abstract realization of quantum classical correspondence.
3. Can these two approaches be equivalent? This might be the case since quantum numbers of the state are not those of the modes of induced spinor fields.

What the scattering data could be for the induced spinor field satisfying modified Dirac equation?

1. If the solution of field equation has hydrodynamic character, the solutions of the modified Dirac equation can be localized to light-like Beltrami flow lines of hydrodynamic flow. These correspond to basic solutions and the general solution is a superposition of these. There is no dispersion and the dynamics is that of geometric optics at the basic level. This means geometric optics like character of the spinor dynamics.

Solutions of the modified Dirac equation are completely analogous to the pulse solutions defining the fundamental solution for the wave equation in the argument leading from wave equation with external time independent potential to Marchenko-Gelfand-Levitan equation allowing to identify potential in terms of scattering data. There is however no potential present now since the interactions are described by the vertices of Feynman diagram where the particle lines meet. Note that particle like regions are Euclidian and that this picture applies only to the Minkowskian exteriors of particles.

2. Partonic 2-surfaces at the ends of the line of generalized Feynman diagram are connected by flow lines. Partonic 2-surfaces at which the signature of the induced metric changes are in a special position. Only the imaginary part of the bi-quaternionic value of the octonion valued map is non-vanishing at these surfaces which can be said to be co-complex 2-surfaces. By geometric optics behavior the scattering data correspond to a diffeomorphism mapping initial partonic 2-surface to the final one in some preferred complex coordinates common to both ends of the line.
3. What could be these preferred coordinates? Complex coordinates for  $S^2$  at light-cone boundary define natural complex coordinates for the partonic 2-surface. With these coordinates the diffeomorphism defining scattering data is diffeomorphism of  $S^2$ . Suppose that this map is real analytic so that maps "real axis" of  $S^2$  to itself. This map would be same as the map defining the octonionic real analyticity as algebraic extension of the complex real analytic map. By octonionic analyticity one can make large number of alternative choices for the coordinates of partonic 2-surface.
4. There can be non-uniqueness due to the possibility of  $G_2/SU(3)$  valued map characterizing the local octonionic units. The proposal is that the choice of octonionic imaginary units can depend on the point of string like orbit: this would give string model in  $G_2/SU(3)$ . Conformal invariance for this string model would imply analyticity and helps considerably but would not probably fix the situation completely since the element of the coset space would constant at the partonic 2-surfaces at the ends of  $CD$ . One can of course ask whether the  $G_2/SU(3)$  element could be constant for each propagator line and would change only at the 2-D vertices?

This would be the inverse scattering problem formulated in the spirit of TGD. There could be also dependence of space-time surface on quantum numbers of quantum states but not on individual solution for the induced spinor field since the scattering data of this solution would be purely geometric.

## 2.10 About deformations of known extremals of Kähler action

I have done a considerable amount of speculative guesswork to identify what I have used to call preferred extremals of Kähler action. The problem is that the mathematical problem at hand is extremely non-linear and that there is no existing mathematical literature. One must proceed by trying to guess the general constraints on the preferred extremals which look physically and mathematically plausible. The hope is that this net of constraints could eventually chrySTALLIZE to Eureka! Certainly the recent speculative picture involves also wrong guesses. The need to find explicit ansatz for the deformations of known extremals based on some common principles has become pressing. The following considerations represent an attempt to combine the existing information to achieve this.

### 2.10.1 What might be the common features of the deformations of known extremals

The dream is to discover the deformations of all known extremals by guessing what is common to all of them. One might hope that the following list summarizes at least some common features.

#### Effective three-dimensionality at the level of action

1. Holography realized as effective 3-dimensionality also at the level of action requires that it reduces to 3-dimensional effective boundary terms. This is achieved if the contraction  $j^\alpha A_\alpha$  vanishes. This is true if  $j^\alpha$  vanishes or is light-like, or if it is proportional to instanton current

in which case current conservation requires that  $CP_2$  projection of the space-time surface is 3-dimensional. The first two options for  $j$  have a realization for known extremals. The status of the third option - proportionality to instanton current - has remained unclear.

2. As I started to work again with the problem, I realized that instanton current could be replaced with a more general current  $j = *B \wedge J$  or concretely:  $j^\alpha = \epsilon^{\alpha\beta\gamma\delta} B_\beta J_{\gamma\delta}$ , where  $B$  is vector field and  $CP_2$  projection is 3-dimensional, which it must be in any case. The contractions of  $j$  appearing in field equations vanish automatically with this ansatz.
3. Almost topological QFT property in turn requires the reduction of effective boundary terms to Chern-Simons terms: this is achieved by boundary conditions expressing weak form of electric magnetic duality. If one generalizes the weak form of electric magnetic duality to  $J = \Phi * J$  one has  $B = d\Phi$  and  $j$  has a vanishing divergence for 3-D  $CP_2$  projection. This is clearly a more general solution ansatz than the one based on proportionality of  $j$  with instanton current and would reduce the field equations in concise notation to  $Tr(TH^k) = 0$ .
4. Any of the alternative properties of the Kähler current implies that the field equations reduce to  $Tr(TH^k) = 0$ , where  $T$  and  $H^k$  are shorthands for Maxwellian energy momentum tensor and second fundamental form and the product of tensors is obvious generalization of matrix product involving index contraction.

### Could Einstein's equations emerge dynamically?

For  $j^\alpha$  satisfying one of the three conditions, the field equations have the same form as the equations for minimal surfaces except that the metric  $g$  is replaced with Maxwell energy momentum tensor  $T$ .

1. This raises the question about dynamical generation of small cosmological constant  $\Lambda$ :  $T = \Lambda g$  would reduce equations to those for minimal surfaces. For  $T = \Lambda g$  modified gamma matrices would reduce to induced gamma matrices and the modified Dirac operator would be proportional to ordinary Dirac operator defined by the induced gamma matrices. One can also consider weak form for  $T = \Lambda g$  obtained by restricting the consideration to sub-space of tangent space so that space-time surface is only "partially" minimal surface but this option is not so elegant although necessary for other than  $CP_2$  type vacuum extremals.
2. What is remarkable is that  $T = \Lambda g$  implies that the divergence of  $T$  which in the general case equals to  $j^\beta J_\beta^\alpha$  vanishes. This is guaranteed by one of the conditions for the Kähler current. Since also Einstein tensor has a vanishing divergence, one can ask whether the condition to  $T = \kappa G + \Lambda g$  could be the general condition. This would give Einstein's equations with cosmological term besides the generalization of the minimal surface equations. GRT would emerge dynamically from the non-linear Maxwell's theory although in slightly different sense as conjectured [K77]! Note that the expression for  $G$  involves also second derivatives of the imbedding space coordinates so that actually a partial differential equation is in question. If field equations reduce to purely algebraic ones, as the basic conjecture states, it is possible to have  $Tr(GH^k) = 0$  and  $Tr(gH^k) = 0$  separately so that also minimal surface equations would hold true.

What is amusing that the first guess for the action of TGD was curvature scalar. It gave analogs of Einstein's equations as a definition of conserved four-momentum currents. The recent proposal would give the analog of ordinary Einstein equations as a dynamical constraint relating Maxwellian energy momentum tensor to Einstein tensor and metric.

3. Minimal surface property is physically extremely nice since field equations can be interpreted as a non-linear generalization of massless wave equation: something very natural for non-linear variant of Maxwell action. The theory would be also very "stringy" although the fundamental action would not be space-time volume. This can however hold true only for Euclidian signature. Note that for  $CP_2$  type vacuum extremals Einstein tensor is proportional to metric so that for them the two options are equivalent. For their small deformations situation changes and it might happen that the presence of  $G$  is necessary. The GRT limit of TGD discussed in [K77] [?] indeed suggests that  $CP_2$  type solutions satisfy Einstein's equations with large cosmological constant and that the small observed value of the cosmological constant is due to averaging and small volume fraction of regions of Euclidian signature (lines of generalized Feynman diagrams).

4. For massless extremals and their deformations  $T = \Lambda g$  cannot hold true. The reason is that for massless extremals energy momentum tensor has component  $T^{vv}$  which actually quite essential for field equations since one has  $H_{vv}^k = 0$ . Hence for massless extremals and their deformations  $T = \Lambda g$  cannot hold true if the induced metric has Hamilton-Jacobi structure meaning that  $g^{uu}$  and  $g^{vv}$  vanish. A more general relationship of form  $T = \kappa G + \Lambda G$  can however be consistent with non-vanishing  $T^{vv}$  but require that deformation has at most 3-D  $CP_2$  projection ( $CP_2$  coordinates do not depend on  $v$ ).
5. The non-determinism of vacuum extremals suggest for their non-vacuum deformations a conflict with the conservation laws. In, also massless extremals are characterized by a non-determinism with respect to the light-like coordinate but like-likeness saves the situation. This suggests that the transformation of a properly chosen time coordinate of vacuum extremal to a light-like coordinate in the induced metric combined with Einstein's equations in the induced metric of the deformation could allow to handle the non-determinism.

### Are complex structure of $CP_2$ and Hamilton-Jacobi structure of $M^4$ respected by the deformations?

The complex structure of  $CP_2$  and Hamilton-Jacobi structure of  $M^4$  could be central for the understanding of the preferred extremal property algebraically.

1. There are reasons to believe that the Hermitian structure of the induced metric ((1,1) structure in complex coordinates) for the deformations of  $CP_2$  type vacuum extremals could be crucial property of the preferred extremals. Also the presence of light-like direction is also an essential elements and 3-dimensionality of  $M^4$  projection could be essential. Hence a good guess is that allowed deformations of  $CP_2$  type vacuum extremals are such that (2,0) and (0,2) components the induced metric and/or of the energy momentum tensor vanish. This gives rise to the conditions implying Virasoro conditions in string models in quantization:

$$g_{\xi^i \xi^j} = 0 \quad , \quad g_{\bar{\xi}^i \bar{\xi}^j} = 0 \quad , \quad i, j = 1, 2 \quad . \quad (2.10.1)$$

Holomorphisms of  $CP_2$  preserve the complex structure and Virasoro conditions are expected to generalize to 4-dimensional conditions involving two complex coordinates. This means that the generators have two integer valued indices but otherwise obey an algebra very similar to the Virasoro algebra. Also the super-conformal variant of this algebra is expected to make sense.

These Virasoro conditions apply in the coordinate space for  $CP_2$  type vacuum extremals. One expects similar conditions hold true also in field space, that is for  $M^4$  coordinates.

2. The integrable decomposition  $M^4(m) = M^2(m) + E^2(m)$  of  $M^4$  tangent space to longitudinal and transversal parts (non-physical and physical polarizations) - Hamilton-Jacobi structure- could be a very general property of preferred extremals and very natural since non-linear Maxwellian electrodynamics is in question. This decomposition led rather early to the introduction of the analog of complex structure in terms of what I called Hamilton-Jacobi coordinates  $(u, v, w, \bar{w})$  for  $M^4$ .  $(u, v)$  defines a pair of light-like coordinates for the local longitudinal space  $M^2(m)$  and  $(w, \bar{w})$  complex coordinates for  $E^2(m)$ . The metric would not contain any cross terms between  $M^2(m)$  and  $E^2(m)$ :  $g_{uw} = g_{vw} = g_{u\bar{w}} = g_{v\bar{w}} = 0$ .

A good guess is that the deformations of massless extremals respect this structure. This condition gives rise to the analog of the constraints leading to Virasoro conditions stating the vanishing of the non-allowed components of the induced metric.  $g_{uu} = g_{vv} = g_{ww} = g_{\bar{w}\bar{w}} = g_{uw} = g_{vw} = g_{u\bar{w}} = g_{v\bar{w}} = 0$ . Again the generators of the algebra would involve two integers and the structure is that of Virasoro algebra and also generalization to super algebra is expected to make sense. The moduli space of Hamilton-Jacobi structures would be part of the moduli space of the preferred extremals and analogous to the space of all possible choices of complex coordinates. The analogs of infinitesimal holomorphic transformations would preserve the modular parameters and give rise to a 4-dimensional Minkowskian analog of Virasoro algebra. The conformal algebra acting on  $CP_2$  coordinates acts in field degrees of freedom for Minkowskian signature.

### Field equations as purely algebraic conditions

If the proposed picture is correct, field equations would reduce basically to purely algebraically conditions stating that the Maxwellian energy momentum tensor has no common index pairs with the second fundamental form. For the deformations of  $CP_2$  type vacuum extremals  $T$  is a complex tensor of type (1,1) and second fundamental form  $H^k$  a tensor of type (2,0) and (0,2) so that  $Tr(TH^k) = 0$  is true. This requires that second light-like coordinate of  $M^4$  is constant so that the  $M^4$  projection is 3-dimensional. For Minkowskian signature of the induced metric Hamilton-Jacobi structure replaces conformal structure. Here the dependence of  $CP_2$  coordinates on second light-like coordinate of  $M^2(m)$  only plays a fundamental role. Note that now  $T^{vv}$  is non-vanishing (and light-like). This picture generalizes to the deformations of cosmic strings and even to the case of vacuum extremals.

### 2.10.2 What small deformations of $CP_2$ type vacuum extremals could be?

I was led to these arguments when I tried find preferred extremals of Kähler action, which would have 4-D  $CP_2$  and  $M^4$  projections - the Maxwell phase analogous to the solutions of Maxwell's equations that I conjectured long time ago. It however turned out that the dimensions of the projections can be ( $D_{M^4} \leq 3, D_{CP_2} = 4$ ) or ( $D_{M^4} = 4, D_{CP_2} \leq 3$ ). What happens is essentially breakdown of linear superposition so that locally one can have superposition of modes which have 4-D wave vectors in the same direction. This is actually very much like quantization of radiation field to photons now represented as separate space-time sheets and one can say that Maxwellian superposition corresponds to union of separate photonic space-time sheets in TGD. In the following I shall restrict the consideration to the deformations of  $CP_2$  type vacuum extremals.

#### Solution ansatz

I proceed by the following arguments to the ansatz.

1. Effective 3-dimensionality for action (holography) requires that action decomposes to vanishing  $j^\alpha A_\alpha$  term + total divergence giving 3-D "boundary" terms. The first term certainly vanishes (giving effective 3-dimensionality) for

$$D_\beta J^{\alpha\beta} = j^\alpha = 0 .$$

Empty space Maxwell equations, something extremely natural. Also for the proposed GRT limit these equations are true.

2. How to obtain empty space Maxwell equations  $j^\alpha = 0$ ? The answer is simple: assume self duality or its slight modification:

$$J = *J$$

holding for  $CP_2$  type vacuum extremals or a more general condition

$$J = k * J ,$$

In the simplest situation  $k$  is some constant not far from unity.  $*$  is Hodge dual involving 4-D permutation symbol.  $k = \text{constant}$  requires that the determinant of the induced metric is apart from constant equal to that of  $CP_2$  metric. It does not require that the induced metric is proportional to the  $CP_2$  metric, which is not possible since  $M^4$  contribution to metric has Minkowskian signature and cannot be therefore proportional to  $CP_2$  metric.

One can consider also a more general situation in which  $k$  is scalar function as a generalization of the weak electric-magnetic duality. In this case the Kähler current is non-vanishing but divergenceless. This also guarantees the reduction to  $Tr(TH^k) = 0$ . In this case however the proportionality of the metric determinant to that for  $CP_2$  metric is not needed. This solution ansatz becomes therefore more general.

- Field equations reduce with these assumptions to equations differing from minimal surfaces equations only in that metric  $g$  is replaced by Maxwellian energy momentum tensor  $T$ . Schematically:

$$\text{Tr}(TH^k) = 0 \ ,$$

where  $T$  is the Maxwellian energy momentum tensor and  $H^k$  is the second fundamental form - asymmetric 2-tensor defined by covariant derivative of gradients of imbedding space coordinates.

#### How to satisfy the condition $\text{Tr}(TH^k) = 0$ ?

It would be nice to have minimal surface equations since they are the non-linear generalization of massless wave equations. It would be also nice to have the vanishing of the terms involving Kähler current in field equations as a consequence of this condition. Indeed,  $T = \kappa G + \Lambda g$  implies this. In the case of  $CP_2$  vacuum extremals one cannot distinguish between these options since  $CP_2$  itself is constant curvature space with  $G \propto g$ . Furthermore, if  $G$  and  $g$  have similar tensor structure the algebraic field equations for  $G$  and  $g$  are satisfied separately so that one obtains minimal surface property also now. In the following minimal surface option is considered.

- The first option is achieved if one has

$$T = \Lambda g \ .$$

Maxwell energy momentum tensor would be proportional to the metric! One would have dynamically generated cosmological constant! This begins to look really interesting since it appeared also at the proposed GRT limit of TGD [?]. Note that here also non-constant value of  $\Lambda$  can be considered and would correspond to a situation in which  $k$  is scalar function: in this case the the determinant condition can be dropped and one obtains just the minimal surface equations.

- Very schematically and forgetting indices and being sloppy with signs, the expression for  $T$  reads as

$$T = JJ - g/4\text{Tr}(JJ) \ .$$

Note that the product of tensors is obtained by generalizing matrix product. This should be proportional to metric.

Self duality implies that  $\text{Tr}(JJ)$  is just the instanton density and does not depend on metric and is constant.

For  $CP_2$  type vacuum extremals one obtains

$$T = -g + g = 0 \ .$$

Cosmological constant would vanish in this case.

- Could it happen that for deformations a small value of cosmological constant is generated? The condition would reduce to

$$JJ = (\Lambda - 1)g \ .$$

$\Lambda$  must relate to the value of parameter  $k$  appearing in the generalized self-duality condition. For the most general ansatz  $\Lambda$  would not be constant anymore.

This would generalize the defining condition for Kähler form

$$JJ = -g \ (i^2 = -1 \text{ geometrically})$$

stating that the square of Kähler form is the negative of metric. The only modification would be that index raising is carried out by using the induced metric containing also  $M^4$  contribution rather than  $CP_2$  metric.

4. Explicitly:

$$J_{\alpha\mu}J^{\mu}_{\beta} = (\Lambda - 1)g_{\alpha\beta} .$$

Cosmological constant would measure the breaking of Kähler structure. By writing  $g = s+m$  and defining index raising of tensors using  $CP_2$  metric and their product accordingly, this condition can be also written as

$$Jm = (\Lambda - 1)mJ .$$

If the parameter  $k$  is constant, the determinant of the induced metric must be proportional to the  $CP_2$  metric. If  $k$  is scalar function, this condition can be dropped. Cosmological constant would not be constant anymore but the dependence on  $k$  would drop out from the field equations and one would hope of obtaining minimal surface equations also now. It however seems that the dimension of  $M^4$  projection cannot be four. For 4-D  $M^4$  projection the contribution of the  $M^2$  part of the  $M^4$  metric gives a non-holomorphic contribution to  $CP_2$  metric and this spoils the field equations.

For  $T = \kappa G + \Lambda g$  option the value of the cosmological constant is large - just as it is for the proposed GRT limit of TGD [K77] [?]. The interpretation in this case is that the average value of cosmological constant is small since the portion of space-time volume containing generalized Feynman diagrams is very small.

#### More detailed ansatz for the deformations of $CP_2$ type vacuum extremals

One can develop the ansatz to a more detailed form. The most obvious guess is that the induced metric is apart from constant conformal factor the metric of  $CP_2$ . This would guarantee self-duality apart from constant factor and  $j^\alpha = 0$ . Metric would be in complex  $CP_2$  coordinates tensor of type (1,1) whereas  $CP_2$  Riemann connection would have only purely holomorphic or anti-holomorphic indices. Therefore  $CP_2$  contributions in  $Tr(TH^k)$  would vanish identically.  $M^4$  degrees of freedom however bring in difficulty. The  $M^4$  contribution to the induced metric should be proportional to  $CP_2$  metric and this is impossible due to the different signatures. The  $M^4$  contribution to the induced metric breaks its Kähler property but would preserve Hermitian structure.

A more realistic guess based on the attempt to construct deformations of  $CP_2$  type vacuum extremals is following.

1. Physical intuition suggests that  $M^4$  coordinates can be chosen so that one has integrable decomposition to longitudinal degrees of freedom parametrized by two light-like coordinates  $u$  and  $v$  and to transversal polarization degrees of freedom parametrized by complex coordinate  $w$  and its conjugate.  $M^4$  metric would reduce in these coordinates to a direct sum of longitudinal and transverse parts. I have called these coordinates Hamilton Jacobi coordinates.
2.  $w$  would be holomorphic function of  $CP_2$  coordinates and therefore satisfy massless wave equation. This would give hopes about rather general solution ansatz.  $u$  and  $v$  cannot be holomorphic functions of  $CP_2$  coordinates. Unless wither  $u$  or  $v$  is constant, the induced metric would receive contributions of type (2,0) and (0,2) coming from  $u$  and  $v$  which would break Kähler structure and complex structure. These contributions would give no-vanishing contribution to all minimal surface equations. Therefore either  $u$  or  $v$  is constant: the coordinate line for non-constant coordinate -say  $u$ - would be analogous to the  $M^4$  projection of  $CP_2$  type vacuum extremal.
3. With these assumptions the induced metric would remain (1,1) tensor and one might hope that  $Tr(TH^k)$  contractions vanishes for all variables except  $u$  because the there are no common index pairs (this if non-vanishing Christoffel symbols for  $H$  involve only holomorphic or anti-holomorphic indices in  $CP_2$  coordinates). For  $u$  one would obtain massless wave equation expressing the minimal surface property.
4. If the value of  $k$  is constant the determinant of the induced metric must be proportional to the determinant of  $CP_2$  metric. The induced metric would contain only the contribution from the transversal degrees of freedom besides  $CP_2$  contribution. Minkowski contribution has however rank 2 as  $CP_2$  tensor and cannot be proportional to  $CP_2$  metric. It is however enough that



its determinant is proportional to the determinant of  $CP_2$  metric with constant proportionality coefficient. This condition gives an additional non-linear condition to the solution. One would have wave equation for  $u$  (also  $w$  and its conjugate satisfy massless wave equation) and determinant condition as an additional condition.

The determinant condition reduces by the linearity of determinant with respect to its rows to sum of conditions involved 0,1,2 rows replaced by the transversal  $M^4$  contribution to metric given if  $M^4$  metric decomposes to direct sum of longitudinal and transversal parts. Derivatives with respect to derivative with respect to particular  $CP_2$  complex coordinate appear linearly in this expression they can depend on  $u$  via the dependence of transversal metric components on  $u$ . The challenge is to show that this equation has (or does not have) non-trivial solutions.

5. If the value of  $k$  is scalar function the situation changes and one has only the minimal surface equations and Virasoro conditions.

What makes the ansatz attractive is that special solutions of Maxwell empty space equations are in question, equations reduces to non-linear generalizations of Euclidian massless wave equations, and possibly space-time dependent cosmological constant pops up dynamically. These properties are true also for the GRT limit of TGD [?].

### 2.10.3 Hamilton-Jacobi conditions in Minkowskian signature

The maximally optimistic guess is that the basic properties of the deformations of  $CP_2$  type vacuum extremals generalize to the deformations of other known extremals such as massless extremals, vacuum extremals with 2-D  $CP_2$  projection which is Lagrangian manifold, and cosmic strings characterized by Minkowskian signature of the induced metric. These properties would be following.

1. The recomposition of  $M^4$  tangent space to longitudinal and transversal parts giving Hamilton-Jacobi structure. The longitudinal part has hypercomplex structure but the second light-like coordinate is constant: this plays a crucial role in guaranteeing the vanishing of contractions in  $Tr(TH^k)$ . It is the algebraic properties of  $g$  and  $T$  which are crucial.  $T$  can however have light-like component  $T^{vv}$ . For the deformations of  $CP_2$  type vacuum extremals (1,1) structure is enough and is guaranteed if second light-like coordinate of  $M^4$  is constant whereas  $w$  is holomorphic function of  $CP_2$  coordinates.
2. What could happen in the case of massless extremals? Now one has 2-D  $CP_2$  projection in the initial situation and  $CP_2$  coordinates depend on light-like coordinate  $u$  and single real transversal coordinate. The generalization would be obvious: dependence on single light-like coordinate  $u$  and holomorphic dependence on  $w$  for complex  $CP_2$  coordinates. The constraint is  $T = \Lambda g$  cannot hold true since  $T^{vv}$  is non-vanishing (and light-like). This property restricted to transversal degrees of freedom could reduce the field equations to minimal surface equations in transversal degrees of freedom. The transversal part of energy momentum tensor would be proportional to metric and hence covariantly constant. Gauge current would remain light-like but would not be given by  $j = *d\phi \wedge J$ .  $T = \kappa G + \Lambda g$  seems to define the attractive option.

It therefore seems that the essential ingredient could be the condition

$$T = \kappa G + \lambda g ,$$

which has structure (1,1) in both  $M^2(m)$  and  $E^2(m)$  degrees of freedom apart from the presence of  $T^{vv}$  component with deformations having no dependence on  $v$ . If the second fundamental form has (2,0)+(0,2) structure, the minimal surface equations are satisfied provided Kähler current satisfies on of the proposed three conditions and if  $G$  and  $g$  have similar tensor structure.

One can actually pose the conditions of metric as complete analogs of stringy constraints leading to Virasoro conditions in quantization to give

$$g_{uu} = 0 , \quad g_{vv} = 0 , \quad g_{ww} = 0 , \quad g_{\bar{w}\bar{w}} = 0 . \quad (2.10.2)$$

This brings in mind the generalization of Virasoro algebra to four-dimensional algebra for which an identification in terms of non-local Yangian symmetry has been proposed [?]. The number of

conditions is four and the same as the number of independent field equations. One can consider similar conditions also for the energy momentum tensor  $T$  but allowing non-vanishing component  $T^{vv}$  if deformations has no  $v$ -dependence. This would solve the field equations if the gauge current vanishes or is light-like. On this case the number of equations is 8. First order differential equations are in question and they can be also interpreted as conditions fixing the coordinates used since there is infinite number of manners to choose the Hamilton-Jacobi coordinates.

One can try to apply the physical intuition about general solutions of field equations in the linear case by writing the solution as a superposition of left and right propagating solutions:

$$\xi^k = f_+^k(u, w) + f_-^k(v, w) . \quad (2.10.3)$$

This could guarantee that second fundamental form is of form  $(2,0)+(0,2)$  in both  $M^2$  and  $E^2$  part of the tangent space and these terms if  $Tr(TH^k)$  vanish identically. The remaining terms involve contractions of  $T^{uw}$ ,  $T^{u\bar{w}}$  and  $T^{vw}$ ,  $T^{v\bar{w}}$  with second fundamental form. Also these terms should sum up to zero or vanish separately. Second fundamental form has components coming from  $f_+^k$  and  $f_-^k$

Second fundamental form  $H^k$  has as basic building bricks terms  $\hat{H}^k$  given by

$$\hat{H}_{\alpha\beta}^k = \partial_\alpha \partial_\beta h^k + \binom{k}{l\ m} \partial_\alpha h^l \partial_\beta h^m . \quad (2.10.4)$$

For the proposed ansatz the first terms give vanishing contribution to  $H_{uv}^k$ . The terms containing Christoffel symbols however give a non-vanishing contribution and one can allow only  $f_+^k$  or  $f_-^k$  as in the case of massless extremals. This reduces the dimension of  $CP_2$  projection to  $D = 3$ .

What about the condition for Kähler current? Kähler form has components of type  $J_{w\bar{w}}$  whose contravariant counterpart gives rise to space-like current component.  $J_{uw}$  and  $J_{u\bar{w}}$  give rise to light-like currents components. The condition would state that the  $J^{w\bar{w}}$  is covariantly constant. Solutions would be characterized by a constant Kähler magnetic field. Also electric field is represent. The interpretation both radiation and magnetic flux tube makes sense.

#### 2.10.4 Deformations of cosmic strings

In the physical applications it has been assumed that the thickening of cosmic strings to Kähler magnetic flux tubes takes place. One indeed expects that the proposed construction generalizes also to the case of cosmic strings having the decomposition  $X^4 = X^2 \times Y^2 \subset M^4 \times CP_2$ , where  $X^2$  is minimal surface and  $Y^2$  a complex homologically non-trivial sub-manifold of  $CP_2$ . Now the starting point structure is Hamilton-Jacobi structure for  $M_m^2 \times Y^2$  defining the coordinate space.

1. The deformation should increase the dimension of either  $CP_2$  or  $M^4$  projection or both. How this thickening could take place? What comes in mind that the string orbits  $X^2$  can be interpreted as a distribution of longitudinal spaces  $M^2(x)$  so that for the deformation  $w$  coordinate becomes a holomorphic function of the natural  $Y^2$  complex coordinate so that  $M^4$  projection becomes 4-D but  $CP_2$  projection remains 2-D. The new contribution to the  $X^2$  part of the induced metric is vanishing and the contribution to the  $Y^2$  part is of type  $(1, 1)$  and the the ansatz  $T = \kappa G + \Lambda g$  might be needed as a generalization of the minimal surface equations The ratio of  $\kappa$  and  $G$  would be determined from the form of the Maxwellian energy momentum tensor and be fixed at the limit of undeformed cosmic strong to  $T = (ag(Y^2) - bg(Y^2))$ . The value of cosmological constant is now large, and overall consistency suggests that  $T = \kappa G + \Lambda g$  is the correct option also for the  $CP_2$  type vacuum extremals.
2. One could also imagine that remaining  $CP_2$  coordinates could depend on the complex coordinate of  $Y^2$  so that also  $CP_2$  projection would become 4-dimensional. The induced metric would receive holomorphic contributions in  $Y^2$  part. As a matter fact, this option is already implied by the assumption that  $Y^2$  is a complex surface of  $CP_2$ .

### 2.10.5 Deformations of vacuum extremals?

What about the deformations of vacuum extremals representable as maps from  $M^4$  to  $CP_2$ ?

1. The basic challenge is the non-determinism of the vacuum extremals. One should perform the deformation so that conservation laws are satisfied. For massless extremals there is also non-determinism but it is associated with the light-like coordinate so that there are no problems with the conservation laws. This would suggest that a properly chosen time coordinate consistent with Hamilton-Jacobi decomposition becomes light-like coordinate in the induced metric. This poses a conditions on the induced metric.
2. Physical intuition suggests that one cannot require  $T = \Lambda g$  since this would mean that the rank of  $T$  is maximal whereas the original situation corresponds to the vanishing of  $T$ . For small deformations rank two for  $T$  looks more natural and one could think that  $T$  is proportional to a projection of metric to a 2-D subspace. The vision about the long length scale limit of TGD is that Einstein's equations are satisfied and this would suggest  $T = kG$  or  $T = \kappa G + \Lambda g$ . The rank of  $T$  could be smaller than four for this ansatz and this conditions binds together the values of  $\kappa$  and  $G$ .
3. These extremals have  $CP_2$  projection which in the generic case is 2-D Lagrangian sub-manifold  $Y^2$ . Again one could assume Hamilton-Jacobi coordinates for  $X^4$ . For  $CP_2$  one could assume Darboux coordinates  $(P_i, Q_i)$ ,  $i = 1, 2$ , in which one has  $A = P_i dQ^i$ , and that  $Y^2 \subset CP_2$  corresponds to  $Q_i = \text{constant}$ . In principle  $P_i$  would depend on arbitrary manner on  $M^4$  coordinates. It might be more convenient to use as coordinates  $(u, v)$  for  $M^2$  and  $(P_1, P_2)$  for  $Y^2$ . This covers also the situation when  $M^4$  projection is not 4-D. By its 2-dimensionality  $Y^2$  allows always a complex structure defined by its induced metric: this complex structure is not consistent with the complex structure of  $CP_2$  ( $Y^2$  is not complex sub-manifold).

Using Hamilton-Jacobi coordinates the pre-image of a given point of  $Y^2$  is a 2-dimensional sub-manifold  $X^2$  of  $X^4$  and defines also 2-D sub-manifold of  $M^4$ . The following picture suggests itself. The projection of  $X^2$  to  $M^4$  can be seen for a suitable choice of Hamilton-Jacobi coordinates as an analog of Lagrangian sub-manifold in  $M^4$  that is as surface for which  $v$  and  $\text{Im}(w)$  vary and  $u$  and  $\text{Re}(w)$  are constant.  $X^2$  would be obtained by allowing  $u$  and  $\text{Re}(w)$  to vary: as a matter fact,  $(P_1, P_2)$  and  $(u, \text{Re}(w))$  would be related to each other. The induced metric should be consistent with this picture. This would requires  $g_{u\text{Re}(w)} = 0$ .

For the deformations  $Q_1$  and  $Q_2$  would become non-constant and they should depend on the second light-like coordinate  $v$  only so that only  $g_{uu}$  and  $g_{uw}$  and  $g_{u\bar{w}}$   $g_{w,w}$  and  $g_{\bar{w},\bar{w}}$  receive contributions which vanish. This would give rise to the analogs of Virasoro conditions guaranteeing that  $T$  is a tensor of form  $(1,1)$  in both  $M^2$  and  $E^2$  indices and that there are no cross components in the induced metric. A more general formulation states that energy momentum tensor satisfies these conditions. The conditions on  $T$  might be equivalent with the conditions for  $g$  and  $G$  separately.

4. Einstein's equations provide an attractive manner to achieve the vanishing of effective 3-dimensionality of the action. Einstein equations would be second order differential equations and the idea that a deformation of vacuum extremal is in question suggests that the dynamics associated with them is in directions transversal to  $Y^2$  so that only the deformation is dictated partially by Einstein's equations.
5. Lagrangian manifolds do not involve complex structure in any obvious manner. One could however ask whether the deformations could involve complex structure in a natural manner in  $CP_2$  degrees of freedom so that the vanishing of  $g_{w\bar{w}}$  would be guaranteed by holomorphy of  $CP_2$  complex coordinate as function of  $w$ .

One should get the complex structure in some natural manner: in other words, the complex structure should relate to the geometry of  $CP_2$  somehow. The complex coordinate defined by say  $z = P_1 + iQ^1$  for the deformation suggests itself. This would suggest that at the limit when one puts  $Q_1 = 0$  one obtains  $P_1 = P_1(\text{Re}(w))$  for the vacuum extremals and the deformation could be seen as an analytic continuation of real function to region of complex plane. This is in spirit with the algebraic approach. The vanishing of Kähler current requires that the Kähler magnetic field is covariantly constant:  $D_z J^{z\bar{z}} = 0$  and  $D_{\bar{z}} J^{z\bar{z}} = 0$  .

6. One could consider the possibility that the resulting 3-D sub-manifold of  $CP_2$  can be regarded as contact manifold with induced Kähler form non-vanishing in 2-D section with natural complex coordinates. The third coordinate variable- call it  $s$ - of the contact manifold and second coordinate of its transversal section would depend on time space-time coordinates for vacuum extremals. The coordinate associated with the transversal section would be continued to a complex coordinate which is holomorphic function of  $w$  and  $u$ .
7. The resulting thickened magnetic flux tubes could be seen as another representation of Kähler magnetic flux tubes: at this time as deformations of vacuum flux tubes rather than cosmic strings. For this ansatz it is however difficult to imagine deformations carrying Kähler electric field.

### 2.10.6 About the interpretation of the generalized conformal algebras

The long-standing challenge has been finding of the direct connection between the super-conformal symmetries assumed in the construction of the geometry of the "world of classical worlds" (WCW) and possible conformal symmetries of field equations. 4-dimensionality and Minkowskian signature have been the basic problems. The recent construction provides new insights to this problem.

1. In the case of string models the quantization of the Fourier coefficients of coordinate variables of the target space gives rise to Kac-Moody type algebra and Virasoro algebra generators are quadratic in these. Also now Kac-Moody type algebra is expected. If one were to perform a quantization of the coefficients in Laurents series for complex  $CP_2$  coordinates, one would obtain interpretation in terms of  $su(3) = u(2) + t$  decomposition, where  $t$  corresponds to  $CP_3$ : the oscillator operators would correspond to generators in  $t$  and their commutator would give generators in  $u(2)$ .  $SU(3)/SU(2)$  coset representation for Kac-Moody algebra would be in question. Kac-Moody algebra would be associated with the generators in both  $M^4$  and  $CP_2$  degrees of freedom. This kind of Kac-Moody algebra appears in quantum TGD.
2. The constraints on induced metric imply a very close resemblance with string models and a generalization of Virasoro algebra emerges. An interesting question is how the two algebras acting on coordinate and field degrees of freedom relate to the super-conformal algebras defined by the symplectic group of  $\delta M_+^4 \times CP_2$  acting on space-like 3-surfaces at boundaries of  $CD$  and to the Kac-Moody algebras acting on light-like 3-surfaces. It has been conjectured that these algebras allow a continuation to the interior of space-time surface made possible by its slicing by 2-surfaces parametrized by 2-surfaces. The proposed construction indeed provides this kind of slicings in both  $M^4$  and  $CP_2$  factor.
3. In the recent case, the algebras defined by the Fourier coefficients of field variables would be Kac-Moody algebras. Virasoro algebra acting on preferred coordinates would be expressed in terms of the Kac-Moody algebra in the standard Sugawara construction applied in string models. The algebra acting on field space would be analogous to the conformal algebra assignable to the symplectic algebra so that also symplectic algebra is present. Stringy pragmatist could imagine quantization of symplectic algebra by replacing  $CP_2$  coordinates in the expressions of Hamiltonians with oscillator operators. This description would be counterpart for the construction of spinor harmonics in WCW and might provide some useful insights.
4. For given type of space-time surface either  $CP_2$  or  $M^4$  corresponds to Kac-Moody algebra but not both. From the point of view of quantum TGD it looks as that something were missing. An analogous problem was encountered at GRT limit of TGD [?]. When Euclidian space-time regions are allowed Einstein-Maxwell action is able to mimic standard model with a surprising accuracy but there is a problem: one obtains either color charges or  $M^4$  charges but not both. Perhaps it is not enough to consider either  $CP_2$  type vacuum extremal or its exterior but both to describe particle: this would give the direct product of the Minkowskian and Euclidian algebras acting on tensor product. This does not however seem to be consistent with the idea that the two descriptions are duality related (the analog of T-duality).

## 2.11 Do geometric invariants of preferred extremals define topological invariants of space-time surface and code for quantum physics?

The recent progress in the understanding of preferred extremals [K9] led to a reduction of the field equations to conditions stating for Euclidian signature the existence of Kähler metric. The resulting conditions are a direct generalization of corresponding conditions emerging for the string world sheet and stating that the 2-metric has only non-diagonal components in complex/hypercomplex coordinates. Also energy momentum of Kähler action has this characteristic (1,1) tensor structure. In Minkowskian signature one obtains the analog of 4-D complex structure combining hyper-complex structure and 2-D complex structure.

The construction lead also to the understanding of how Einstein's equations with cosmological term follow as a consistency condition guaranteeing that the covariant divergence of the Maxwell's energy momentum tensor assignable to Kähler action vanishes. This gives  $T = kG + \Lambda g$ . By taking trace a further condition follows from the vanishing trace of  $T$ :

$$R = \frac{4\Lambda}{k} . \tag{2.11.1}$$

That any preferred extremal should have a constant Ricci scalar proportional to cosmological constant is very strong prediction. Note however that both  $\Lambda$  and  $k \propto 1/G$  are both parameters characterizing one particular preferred extremal. One could of course argue that the dynamics allowing only constant curvature space-times is too simple. The point is however that particle can topologically condense on several space-time sheets meaning effective superposition of various classical fields defined by induced metric and spinor connection.

The following considerations demonstrate that preferred extremals can be seen as canonical representatives for the constant curvature manifolds playing central role in Thurston's geometrization theorem [?] known also as hyperbolization theorem implying that geometric invariants of space-time surfaces transform to topological invariants. The generalization of the notion of Ricci flow to Maxwell flow in the space of metrics and further to Kähler flow for preferred extremals in turn gives a rather detailed vision about how preferred extremals organize to one-parameter orbits. It is quite possible that Kähler flow is actually discrete. The natural interpretation is in terms of dissipation and self organization. Somewhat surprisingly, hyperbolization theorem stating that very many 4-manifolds allow a metric with negative constant curvature gives a first principle explanation for the small negative value of cosmological constant implying accelerated cosmic expansion!

Quantum classical correspondence suggests that this line of thought could be continued even further: could the geometric invariants of the preferred extremals code not only for space-time topology but also for quantum physics? How to calculate the correlation functions and coupling constant evolution has remained a basic unresolved challenge of quantum TGD. Could the correlation functions be reduced to statistical geometric invariants of preferred extremals? The latest (means the end of 2012) and perhaps the most powerful idea hitherto about coupling constant evolution is quantum classical correspondence in statistical sense stating that the statistical properties of a preferred extremal in quantum superposition of them are same as those of the zero energy state in question. This principle would be quantum generalization of ergodic theorem stating that the time evolution of a single member of ensemble represents the ensemble statistically. This principle would allow to deduce correlation functions and S-matrix from the statistical properties of single preferred extremal alone using classical intuition. Also coupling constant evolution would be coded by the statistical properties of the representative preferred extremal.

### 2.11.1 Preferred extremals of Kähler action as manifolds with constant Ricci scalar whose geometric invariants are topological invariants

An old conjecture inspired by the preferred extremal property is that the geometric invariants of space-time surface serve as topological invariants. The reduction of Kähler action to 3-D Chern-Simons terms [K9] gives support for this conjecture as a classical counterpart for the view about TGD

as almost topological QFT. The following arguments give a more precise content to this conjecture in terms of existing mathematics.

1. It is not possible to represent the scaling of the induced metric as a deformation of the space-time surface preserving the preferred extremal property since the scale of  $CP_2$  breaks scale invariance. Therefore the curvature scalar cannot be chosen to be equal to one numerically. Therefore also the parameter  $R = 4\Lambda/k$  and also  $\Lambda$  and  $k$  separately characterize the equivalence class of preferred extremals as is also physically clear.

Also the volume of the space-time sheet closed inside causal diamond  $CD$  remains constant along the orbits of the flow and thus characterizes the space-time surface.  $\Lambda$  and even  $k \propto 1/G$  can indeed depend on space-time sheet and p-adic length scale hypothesis suggests a discrete spectrum for  $\Lambda/k$  expressible in terms of p-adic length scales:  $\Lambda/k \propto 1/L_p^2$  with  $p \simeq 2^k$  favored by p-adic length scale hypothesis. During cosmic evolution the p-adic length scale would increase gradually. This would resolve the problem posed by cosmological constant in GRT based theories.

2. One could also see the preferred extremals as 4-D counterparts of constant curvature 3-manifolds in the topology of 3-manifolds. An interesting possibility raised by the observed negative value of  $\Lambda$  is that most 4-surfaces are constant negative curvature 4-manifolds. By a general theorem coset spaces  $H^4/\Gamma$ , where  $H^4 = SO(1,4)/SO(4)$  is hyperboloid of  $M^5$  and  $\Gamma$  a torsion free discrete subgroup of  $SO(1,4)$  [?]. It is not clear to me, whether the constant value of Ricci scalar implies constant sectional curvatures and therefore hyperbolic space property. It could happen that the space of spaces with constant Ricci curvature contain a hyperbolic manifold as an especially symmetric representative. In any case, the geometric invariants of hyperbolic metric are topological invariants.

By Mostow rigidity theorem [?] finite-volume hyperbolic manifold is unique for  $D > 2$  and determined by the fundamental group of the manifold. Since the orbits under the Kähler flow preserve the curvature scalar the manifolds at the orbit must represent different imbeddings of one and hyperbolic 4-manifold. In 2-D case the moduli space for hyperbolic metric for a given genus  $g > 0$  is defined by Teichmueller parameters and has dimension  $6(g - 1)$ . Obviously the exceptional character of  $D = 2$  case relates to conformal invariance. Note that the moduli space in question plays a key role in p-adic mass calculations [K16].

In the recent case Mostow rigidity theorem could hold true for the Euclidian regions and maybe generalize also to Minkowskian regions. If so then both "topological" and "geometro" in "Topological Geometrodynamics" would be fully justified. The fact that geometric invariants become topological invariants also conforms with "TGD as almost topological QFT" and allows the notion of scale to find its place in topology. Also the dream about exact solvability of the theory would be realized in rather convincing manner.

These conjectures are the main result independent of whether the generalization of the Ricci flow discussed in the sequel exists as a continuous flow or possibly discrete sequence of iterates in the space of preferred extremals of Kähler action. My sincere hope is that the reader could grasp how far reaching these result really are.

### 2.11.2 Is there a connection between preferred extremals and AdS<sub>4</sub>/CFT correspondence?

The preferred extremals satisfy Einstein Maxwell equations with a cosmological constant and have negative curvature for negative value of  $\Lambda$ . 4-D space-times with hyperbolic metric provide canonical representation for a large class of four-manifolds and an interesting question is whether these spaces are obtained as preferred extremals and/or vacuum extremals.

4-D hyperbolic space with Minkowski signature is locally isometric with AdS<sub>4</sub>. This suggests at connection with AdS<sub>4</sub>/CFT correspondence of M-theory. The boundary of AdS would be now replaced with 3-D light-like orbit of partonic 2-surface at which the signature of the induced metric changes. The metric 2-dimensionality of the light-like surface makes possible generalization of 2-D conformal invariance with the light-like coordinate taking the role of complex coordinate at light-like boundary. AdS would presumably represent a special case of a more general family of space-time surfaces with constant Ricci scalar satisfying Einstein-Maxwell equations and generalizing the AdS<sub>4</sub>/CFT correspondence.

This gives motivations for finding whether AdS<sub>4</sub> allows an imbedding as a vacuum extremal to  $M^4 \times S^2 \subset M^4 \times CP_2$ , where  $S^2$  is a homologically trivial geodesic sphere of  $CP_2$ . It is easy to guess the general form of the imbedding by writing the line elements of,  $M^4$ ,  $S^2$ , and AdS<sub>4</sub>.

1. The line element of  $M^4$  in spherical Minkowski coordinates  $(m, r_M, \theta, \phi)$  reads as

$$ds^2 = dm^2 - dr_M^2 - r_M^2 d\Omega^2 . \quad (2.11.2)$$

2. Also the line element of  $S^2$  is familiar:

$$ds^2 = -R^2(d\Theta^2 + \sin^2(\theta)d\Phi^2) . \quad (2.11.3)$$

3. By visiting in Wikipedia one learns that in spherical coordinate the line element of AdS<sub>4</sub> is given by

$$\begin{aligned} ds^2 &= A(r)dt^2 - \frac{1}{A(r)}dr^2 - r^2d\Omega^2 , \\ A(r) &= 1 + y^2 , \quad y = \frac{r}{r_0} . \end{aligned} \quad (2.11.4)$$

4. From these formulas it is easy to see that the ansatz is of the same general form as for the imbedding of Schwarzschild-Nordstöm metric:

$$\begin{aligned} m &= \Lambda t + h(y) , \quad r_M = r , \\ \Theta &= s(y) , \quad \Phi = \omega(t + f(y)) . \end{aligned} \quad (2.11.5)$$

The non-trivial conditions on the components of the induced metric are given by

$$\begin{aligned} g_{tt} &= \Lambda^2 - x^2 \sin^2(\Theta) = A(r) , \\ g_{tr} &= \frac{1}{r_0} \left[ \Lambda \frac{dh}{dy} - x^2 \sin^2(\theta) \frac{df}{dr} \right] = 0 , \\ g_{rr} &= \frac{1}{r_0^2} \left[ \left( \frac{dh}{dy} \right)^2 - 1 - x^2 \sin^2(\theta) \left( \frac{df}{dy} \right)^2 - R^2 \left( \frac{d\Theta}{dy} \right)^2 \right] = -\frac{1}{A(r)} , \\ x &= R\omega . \end{aligned} \quad (2.11.6)$$

By some simple algebraic manipulations one can derive expressions for  $\sin(\Theta)$ ,  $df/dr$  and  $dh/dr$ .

1. For  $\Theta(r)$  the equation for  $g_{tt}$  gives the expression

$$\begin{aligned} \sin(\Theta) &= \pm \frac{P^{1/2}}{x} , \\ P &= \Lambda^2 - A = \Lambda^2 - 1 - y^2 . \end{aligned} \quad (2.11.7)$$

The condition  $0 \leq \sin^2(\Theta) \leq 1$  gives the conditions

$$(\Lambda^2 - x^2 - 1)^{1/2} \leq y \leq (\Lambda^2 - 1)^{1/2} . \quad (2.11.8)$$

Clearly only a spherical shell is possible.

2. From the vanishing of  $g_{tr}$  one obtains

$$\frac{dh}{dy} = \frac{P}{\Lambda} \frac{df}{dy} , \quad (2.11.9)$$

3. The condition for  $g_{rr}$  gives

$$\left(\frac{df}{dy}\right)^2 = \text{frac} r_0^2 AP [A^{-1} - R^2 \left(\frac{d\Theta}{dy}\right)^2] . \quad (2.11.10)$$

Clearly, the right-hand side is positive if  $P \geq 0$  holds true and  $Rd\Theta/dy$  is small. From this condition one can solve by expressing  $d\Theta/dy$  using chain rule as

$$\left(\frac{d\Theta}{dy}\right)^2 = \frac{x^2 y^2}{P(P-x^2)} . \quad (2.11.11)$$

One obtains

$$\left(\frac{df}{dy}\right)^2 = \Lambda r_0^2 \frac{y^2}{AP} \left[ \frac{1}{1+y^2} - x^2 \left(\frac{R}{r_0}\right)^2 \frac{1}{P(P-x^2)} \right] . \quad (2.11.12)$$

The right hand side of this equation is non-negative for certain range of parameters and variable  $y$ . Note that for  $r_0 \gg R$  the second term on the right hand side can be neglected. In this case it is easy to integrate  $f(y)$ .

The conclusion is that  $\text{AdS}_4$  allows a local imbedding as a vacuum extremal. Whether also an imbedding as a non-vacuum preferred extremal to homologically non-trivial geodesic sphere is possible, is an interesting question.

### 2.11.3 Generalizing Ricci flow to Maxwell flow for 4-geometries and Kähler flow for space-time surfaces

The notion of Ricci flow has played a key part in the geometrization of topological invariants of Riemann manifolds. I certainly did not have this in mind when I choose to call my unification attempt "Topological Geometrodynamics" but this title strongly suggests that a suitable generalization of Ricci flow could play a key role in the understanding of also TGD.

#### Ricci flow and Maxwell flow for 4-geometries

The observation about constancy of 4-D curvature scalar for preferred extremals inspires a generalization of the well-known volume preserving Ricci flow [?] introduced by Richard Hamilton. Ricci flow is defined in the space of Riemann metrics as

$$\frac{dg_{\alpha\beta}}{dt} = -2R_{\alpha\beta} + 2\frac{R_{avg}}{D} g_{\alpha\beta} . \quad (2.11.13)$$

Here  $R_{avg}$  denotes the average of the scalar curvature, and  $D$  is the dimension of the Riemann manifold. The flow is volume preserving in average sense as one easily checks ( $\langle g^{\alpha\beta} dg_{\alpha\beta}/dt \rangle = 0$ ). The volume preserving property of this flow allows to intuitively understand that the volume of a 3-manifold in the



asymptotic metric defined by the Ricci flow is topological invariant. The fixed points of the flow serve as canonical representatives for the topological equivalence classes of 3-manifolds. These 3-manifolds (for instance hyperbolic 3-manifolds with constant sectional curvatures) are highly symmetric. This is easy to understand since the flow is dissipative and destroys all details from the metric.

What happens in the recent case? The first thing to do is to consider what might be called Maxwell flow in the space of all 4-D Riemann manifolds allowing Maxwell field.

1. First of all, the vanishing of the trace of Maxwell's energy momentum tensor codes for the volume preserving character of the flow defined as

$$\frac{dg_{\alpha\beta}}{dt} = T_{\alpha\beta} . \quad (2.11.14)$$

Taking covariant divergence on both sides and assuming that  $d/dt$  and  $D_\alpha$  commute, one obtains that  $T^{\alpha\beta}$  is divergenceless.

This is true if one assumes Einstein's equations with cosmological term. This gives

$$\frac{dg_{\alpha\beta}}{dt} = kG_{\alpha\beta} + \Lambda g_{\alpha\beta} = kR_{\alpha\beta} + \left(-\frac{kR}{2} + \Lambda\right)g_{\alpha\beta} . \quad (2.11.15)$$

The trace of this equation gives that the curvature scalar is constant. Note that the value of the Kähler coupling strength plays a highly non-trivial role in these equations and it is quite possible that solutions exist only for some critical values of  $\alpha_K$ . Quantum criticality should fix the allow value triplets  $(G, \Lambda, \alpha_K)$  apart from overall scaling

$$(G, \Lambda, \alpha_K) \rightarrow (xG, \Lambda/x, x\alpha_K) .$$

Fixing the value of  $G$  fixes the values remaining parameters at critical points. The rescaling of the parameter  $t$  induces a scaling by  $x$ .

2. By taking trace one obtains the already mentioned condition fixing the curvature to be constant, and one can write

$$\frac{dg_{\alpha\beta}}{dt} = kR_{\alpha\beta} - \Lambda g_{\alpha\beta} . \quad (2.11.16)$$

Note that in the recent case  $R_{avg} = R$  holds true since curvature scalar is constant. The fixed points of the flow would be Einstein manifolds [?, ?] satisfying

$$R_{\alpha\beta} = \frac{\Lambda}{k}g_{\alpha\beta} \quad (2.11.17)$$

3. It is by no means obvious that continuous flow is possible. The condition that Einstein-Maxwell equations are satisfied might pick up from a completely general Maxwell flow a discrete subset as solutions of Einstein-Maxwell equations with a cosmological term. If so, one could assign to this subset a sequence of values  $t_n$  of the flow parameter  $t$ .

4. I do not know whether 3-dimensionality is somehow absolutely essential for getting the topological classification of closed 3-manifolds using Ricci flow. This ignorance allows me to pose some innocent questions. Could one have a canonical representation of 4-geometries as spaces with constant Ricci scalar? Could one select one particular Einstein space in the class four-metrics and could the ratio  $\Lambda/k$  represent topological invariant if one normalizes metric or curvature scalar suitably. In the 3-dimensional case curvature scalar is normalized to unity. In the recent case this normalization would give  $k = 4\Lambda$  in turn giving  $R_{\alpha\beta} = g_{\alpha\beta}/4$ . Does this mean that there is only single fixed point in local sense, analogous to black hole toward which all geometries are driven by the Maxwell flow? Does this imply that only the 4-volume of the original space would serve as a topological invariant?

### Maxwell flow for space-time surfaces

One can consider Maxwell flow for space-time surfaces too. In this case Kähler flow would be the appropriate term and provides families of preferred extremals. Since space-time surfaces inside CD are the basic physical objects are in TGD framework, a possible interpretation of these families would be as flows describing physical dissipation as a four-dimensional phenomenon polishing details from the space-time surface interpreted as an analog of Bohr orbit.

1. The flow is now induced by a vector field  $j^k(x, t)$  of the space-time surface having values in the tangent bundle of imbedding space  $M^4 \times CP_2$ . In the most general case one has Kähler flow without the Einstein equations. This flow would be defined in the space of all space-time surfaces or possibly in the space of all extremals. The flow equations reduce to

$$h_{kl}D_\alpha j^k(x, t)D_\beta h^l = \frac{1}{2}T_{\alpha\beta} . \quad (2.11.18)$$

The left hand side is the projection of the covariant gradient  $D_\alpha j^k(x, t)$  of the flow vector field  $j^k(x, t)$  to the tangent space of the space-time surface.  $D_{alpha}$  is covariant derivative taking into account that  $j^k$  is imbedding space vector field. For a fixed point space-time surface this projection must vanish assuming that this space-time surface reachable. A good guess for the asymptotia is that the divergence of Maxwell energy momentum tensor vanishes and that Einstein's equations with cosmological constant are well-defined.

Asymptotes corresponds to vacuum extremals. In Euclidian regions  $CP_2$  type vacuum extremals and in Minkowskian regions to any space-time surface in any 6-D sub-manifold  $M^4 \times Y^2$ , where  $Y^2$  is Lagrangian sub-manifold of  $CP_2$  having therefore vanishing induced Kähler form. Symplectic transformations of  $CP_2$  combined with diffeomorphisms of  $M^4$  give new Lagrangian manifolds. One would expect that vacuum extremals are approached but never reached at second extreme for the flow.

If one assumes Einstein's equations with a cosmological term, allowed vacuum extremals must be Einstein manifolds. For  $CP_2$  type vacuum extremals this is the case. It is quite possible that these fixed points do not actually exist in Minkowskian sector, and could be replaced with more complex asymptotic behavior such as limit, chaos, or strange attractor.

2. The flow could be also restricted to the space of preferred extremals. Assuming that Einstein Maxwell equations indeed hold true, the flow equations reduce to

$$h_{kl}D_\alpha j^k(x, t)\partial_\beta h^l = \frac{1}{2}(kR_{\alpha\beta} - \Lambda g_{\alpha\beta}) . \quad (2.11.19)$$

Preferred extremals would correspond to a fixed sub-manifold of the general flow in the space of all 4-surfaces.

3. One can also consider a situation in which  $j^k(x, t)$  is replaced with  $j^k(h, t)$  defining a flow in the entire imbedding space. This assumption is probably too restrictive. In this case the equations reduce to

$$(D_r j_l(x, t) + D_l j_r) \partial_\alpha h^r \partial_\beta h^l = k R_{\alpha\beta} - \Lambda g_{\alpha\beta} . \quad (2.11.20)$$

Here  $D_r$  denotes covariant derivative. Asymptotia is achieved if the tensor  $D_k j_l + D_l j_k$  becomes orthogonal to the space-time surface. Note for that Killing vector fields of  $H$  the left hand side vanishes identically. Killing vector fields are indeed symmetries of also asymptotic states.

It must be made clear that the existence of a continuous flow in the space of preferred extremals might be too strong a condition. Already the restriction of the general Maxwell flow in the space of metrics to solutions of Einstein-Maxwell equations with cosmological term might lead to discretization, and the assumption about representability as 4-surface in  $M^4 \times CP_2$  would give a further condition reducing the number of solutions. On the other hand, one might consider a possibility of a continuous flow in the space of constant Ricci scalar metrics with a fixed 4-volume and having hyperbolic spaces as the most symmetric representative.

#### Dissipation, self organization, transition to chaos, and coupling constant evolution

A beautiful connection with concepts like dissipation, self-organization, transition to chaos, and coupling constant evolution suggests itself.

1. It is not at all clear whether the vacuum extremal limits of the preferred extremals can correspond to Einstein spaces except in special cases such as  $CP_2$  type vacuum extremals isometric with  $CP_2$ . The imbeddability condition however defines a constraint force which might well force asymptotically more complex situations such as limit cycles and strange attractors. In ordinary dissipative dynamics an external energy feed is essential prerequisite for this kind of non-trivial self-organization patterns.

In the recent case the external energy feed could be replaced by the constraint forces due to the imbeddability condition. It is not too difficult to imagine that the flow (if it exists!) could define something analogous to a transition to chaos taking place in a stepwise manner for critical values of the parameter  $t$ . Alternatively, these discrete values could correspond to those values of  $t$  for which the preferred extremal property holds true for a general Maxwell flow in the space of 4-metrics. Therefore the preferred extremals of Kähler action could emerge as one-parameter (possibly discrete) families describing dissipation and self-organization at the level of space-time dynamics.

2. For instance, one can consider the possibility that in some situations Einstein's equations split into two mutually consistent equations of which only the first one is independent

$$\begin{aligned} x J^\alpha{}_\nu J^{\nu\beta} &= R^{\alpha\beta} , \\ L_K &= x J^\alpha{}_\nu J^{\nu\beta} = 4\Lambda , \\ x &= \frac{1}{16\pi\alpha_K} . \end{aligned} \quad (2.11.21)$$

Note that the first equation indeed gives the second one by tracing. This happens for  $CP_2$  type vacuum extremals.

Kähler action density would reduce to cosmological constant which should have a continuous spectrum if this happens always. A more plausible alternative is that this holds true only asymptotically. In this case the flow equation could not lead arbitrary near to vacuum extremal, and one can think of situation in which  $L_K = 4\Lambda$  defines an analog of limiting cycle or perhaps even strange attractor. In any case, the assumption would allow to deduce the asymptotic value

of the action density which is of utmost importance from calculational point of view: action would be simply  $S_K = 4\Lambda V_4$  and one could also say that one has minimal surface with  $\Lambda$  taking the role of string tension.

3. One of the key ideas of TGD is quantum criticality implying that Kähler coupling strength is analogous to critical temperature. Second key idea is that p-adic coupling constant evolution represents discretized version of continuous coupling constant evolution so that each p-adic prime would correspond a fixed point of ordinary coupling constant evolution in the sense that the 4-volume characterized by the p-adic length scale remains constant. The invariance of the geometric and thus geometric parameters of hyperbolic 4-manifold under the Kähler flow would conform with the interpretation as a flow preserving scale assignable to a given p-adic prime. The continuous evolution in question (if possible at all!) might correspond to a fixed p-adic prime. Also the hierarchy of Planck constants relates to this picture naturally. Planck constant  $\hbar_{eff} = n\hbar$  corresponds to a multi-furcation generating n-sheeted structure and certainly affecting the fundamental group.
4. One can of course question the assumption that a continuous flow exists. The property of being a solution of Einstein-Maxwell equations, imbeddability property, and preferred extremal property might allow only discrete sequences of space-time surfaces perhaps interpretable as orbit of an iterated map leading gradually to a fractal limit. This kind of discrete sequence might be also be selected as preferred extremals from the orbit of Maxwell flow without assuming Einstein-Maxwell equations. Perhaps the discrete p-adic coupling constant evolution could be seen in this manner and be regarded as an iteration so that the connection with fractality would become obvious too.

#### Does a 4-D counterpart of thermodynamics make sense?

The interpretation of the Kähler flow in terms of dissipation, the constancy of  $R$ , and almost constancy of  $L_K$  suggest an interpretation in terms of 4-D variant of thermodynamics natural in zero energy ontology (ZEO), where physical states are analogs for pairs of initial and final states of quantum event are quantum superpositions of classical time evolutions. Quantum theory becomes a "square root" of thermodynamics so that 4-D analog of thermodynamics might even replace ordinary thermodynamics as a fundamental description. If so this 4-D thermodynamics should be qualitatively consistent with the ordinary 3-D thermodynamics.

1. The first naive guess would be the interpretation of the action density  $L_K$  as an analog of energy density  $e = E/V_3$  and that of  $R$  as the analog to entropy density  $s = S/V_3$ . The asymptotic states would be analogs of thermodynamical equilibria having constant values of  $L_K$  and  $R$ .
2. Apart from an overall sign factor  $\epsilon$  to be discussed, the analog of the first law  $de = Tds - pdV/V$  would be

$$dL_K = kdR + \Lambda \frac{dV_4}{V_4} .$$

One would have the correspondences  $S \rightarrow \epsilon RV_4$ ,  $e \rightarrow \epsilon L_K$  and  $k \rightarrow T$ ,  $p \rightarrow -\Lambda$ .  $k \propto 1/G$  indeed appears formally in the role of temperature in Einstein's action defining a formal partition function via its exponent. The analog of second law would state the increase of the magnitude of  $\epsilon RV_4$  during the Kähler flow.

3. One must be very careful with the signs and discuss Euclidian and Minkowskian regions separately. Concerning purely thermodynamic aspects at the level of vacuum functional Euclidian regions are those which matter.
  - (a) For  $CP_2$  type vacuum extremals  $L_K \propto E^2 + B^2$ ,  $R = \Lambda/k$ , and  $\Lambda$  are positive. In thermodynamical analogy for  $\epsilon = 1$  this would mean that pressure is negative.
  - (b) In Minkowskian regions the value of  $R = \Lambda/k$  is negative for  $\Lambda < 0$  suggested by the large abundance of 4-manifolds allowing hyperbolic metric and also by cosmological considerations. The asymptotic formula  $L_K = 4\Lambda$  considered above suggests that also Kähler action

is negative in Minkowskian regions for magnetic flux tubes dominating in TGD inspired cosmology: the reason is that the magnetic contribution to the action density  $L_K \propto E^2 - B^2$  dominates.

Consider now in more detail the 4-D thermodynamics interpretation in Euclidian and Minkowskian regions assuming that the evolution by quantum jumps has Kähler flow as a space-time correlate.

1. In Euclidian regions the choice  $\epsilon = 1$  seems to be more reasonable one. In Euclidian regions  $-\Lambda$  as the analog of pressure would be negative, and asymptotically (that is for  $CP_2$  type vacuum extremals) its value would be proportional to  $\Lambda \propto 1/GR^2$ , where  $R$  denotes  $CP_2$  radius defined by the length of its geodesic circle.

A possible interpretation for negative pressure is in terms of string tension effectively inducing negative pressure (note that the solutions of the modified Dirac equation indeed assign a string to the wormhole contact). The analog of the second law would require the increase of  $RV_4$  in quantum jumps. The magnitudes of  $L_K$ ,  $R$ ,  $V_4$  and  $\Lambda$  would be reduced and approach their asymptotic values. In particular,  $V_4$  would approach asymptotically the volume of  $CP_2$ .

2. In Minkowskian regions Kähler action contributes to the vacuum functional a phase factor analogous to an imaginary exponent of action serving in the role of Morse function so that thermodynamics interpretation can be questioned. Despite this one can check whether thermodynamic interpretation can be considered. The choice  $\epsilon = -1$  seems to be the correct choice now.  $-\Lambda$  would be analogous to a negative pressure whose gradually decreases. In 3-D thermodynamics it is natural to assign negative pressure to the magnetic flux tube like structures as their effective string tension defined by the density of magnetic energy per unit length.  $-R \geq 0$  would entropy and  $-L_K \geq 0$  would be the analog of energy density.

$R = \Lambda/k$  and the reduction of  $\Lambda$  during cosmic evolution by quantum jumps suggests that the larger the volume of CD and thus of (at least) Minkowskian space-time sheet the smaller the negative value of  $\Lambda$ .

Assume the recent view about state function reduction explaining how the arrow of geometric time is induced by the quantum jump sequence defining experienced time [?]. According to this view zero energy states are quantum superpositions over  $CD$ s of various size scales but with common tip, which can correspond to either the upper or lower light-like boundary of  $CD$ . The sequence of quantum jumps the gradual increase of the average size of  $CD$  in the quantum superposition and therefore that of average value of  $V_4$ . On the other hand, a gradual decrease of both  $-L_K$  and  $-R$  looks physically very natural. If Kähler flow describes the effect of dissipation by quantum jumps in ZEO then the space-time surfaces would gradually approach nearly vacuum extremals with constant value of entropy density  $-R$  but gradually increasing 4-volume so that the analog of second law stating the increase of  $-RV_4$  would hold true.

3. The interpretation of  $-R > 0$  as negentropy density assignable to entanglement is also possible and is consistent with the interpretation in terms of second law. This interpretation would only change the sign factor  $\epsilon$  in the proposed formula. Otherwise the above arguments would remain as such.

#### 2.11.4 Could correlation functions, S-matrix, and coupling constant evolution be coded the statistical properties of preferred extremals?

Quantum classical correspondence states that all aspects of quantum states should have correlates in the geometry of preferred extremals. In particular, various elementary particle propagators should have a representation as properties of preferred extremals. This would allow to realize the old dream about being able to say something interesting about coupling constant evolution although it is not yet possible to calculate the M-matrices and U-matrix. Hitherto everything that has been said about coupling constant evolution has been rather speculative arguments except for the general vision that it reduces to a discrete evolution defined by p-adic length scales. General first principle definitions are however much more valuable than ad hoc guesses even if the latter give rise to explicit formulas.

In quantum TGD and also at its QFT limit various correlation functions in given quantum state should code for its properties. By quantum classical correspondence these correlation functions should

have counterparts in the geometry of preferred extremals. Even more: these classical counterparts for a given preferred extremal ought to be identical with the quantum correlation functions for the superposition of preferred extremals. This correspondence could be called quantum ergodicity by its analogy with ordinary ergodicity stating that the member of ensemble becomes representative of ensemble.

1. The marvelous implication of quantum ergodicity would be that one could calculate everything solely classically using the classical intuition - the only intuition that we have. Quantum ergodicity would also solve the paradox raised by the quantum classical correspondence for momentum eigenstates. Any preferred extremal in their superposition defining momentum eigenstate should code for the momentum characterizing the superposition itself. This is indeed possible if every extremal in the superposition codes the momentum to the properties of classical correlation functions which are identical for all of them.
2. The only manner to possibly achieve quantum ergodicity is in terms of the statistical properties of the preferred extremals. It should be possible to generalize the ergodic theorem stating that the properties of statistical ensemble are represented by single space-time evolution in the ensemble of time evolutions. Quantum superposition of classical worlds would effectively reduce to single classical world as far as classical correlation functions are considered. The notion of finite measurement resolution suggests that one must state this more precisely by adding that classical correlation functions are calculated in a given UV and IR resolutions meaning UV cutoff defined by the smallest CD and IR cutoff defined by the largest CD present.
3. The skeptic inside me immediately argues that TGD Universe is 4-D spin glass so that this quantum ergodic theorem must be broken. In the case of the ordinary spin glasses one has not only statistical average for a fixed Hamiltonian but a statistical average over Hamiltonians. There is a probability distribution over the coupling parameters appearing in the Hamiltonian. Maybe the quantum counterpart of this is needed to predict the physically measurable correlation functions.

Could this average be an ordinary classical statistical average over quantum states with different classical correlation functions? This kind of average is indeed taken in density matrix formalism. Or could it be that the square root of thermodynamics defined by ZEO actually gives automatically rise to this average? The eigenvalues of the "hermitian square root" of the density matrix would code for components of the state characterized by different classical correlation functions. One could assign these contributions to different "phases".

4. Quantum classical correspondence in statistical sense would be very much like holography (now individual classical state represents the entire quantum state). Quantum ergodicity would pose a rather strong constraint on quantum states. This symmetry principle could actually fix the spectrum of zero energy states to a high degree and fix therefore the M-matrices given by the product of hermitian square root of density matrix and unitary S-matrix and unitary U-matrix having M-matrices as its orthonormal rows.
5. In TGD inspired theory of consciousness the counterpart of quantum ergodicity is the postulate that the space-time geometry provides a symbolic representation for the quantum states and also for the contents of consciousness assignable to quantum jumps between quantum states. Quantum ergodicity would realize this strongly self-referential looking condition. The positive and negative energy parts of zero energy state would be analogous to the initial and final states of quantum jump and the classical correlation functions would code for the contents of consciousness like written formulas code for the thoughts of mathematician and provide a sensory feedback.

How classical correlation functions should be defined?

1. General Coordinate Invariance and Lorentz invariance are the basic constraints on the definition. These are achieved for the space-time regions with Minkowskian signature and 4-D  $M^4$  projection if linear Minkowski coordinates are used. This is equivalent with the contraction of the indices of tensor fields with the space-time projections of  $M^4$  Killing vector fields representing translations.

Accepting this generalization, there is no need to restrict oneself to 4-D  $M^4$  projection and one can also consider also Euclidian regions identifiable as lines of generalized Feynman diagrams.

Quantum ergodicity very probably however forces to restrict the consideration to Minkowskian and Euclidian space-time regions and various phases associated with them. Also  $CP_2$  Killing vector fields can be projected to space-time surface and give a representation for classical gluon fields. These in turn can be contracted with  $M^4$  Killing vectors giving rise to gluon fields as analogs of graviton fields but with second polarization index replaced with color index.

2. The standard definition for the correlation functions associated with classical time evolution is the appropriate starting point. The correlation function  $G_{XY}(\tau)$  for two dynamical variables  $X(t)$  and  $Y(t)$  is defined as the average  $G_{XY}(\tau) = \int_T X(t)Y(t+\tau)dt/T$  over an interval of length  $T$ , and one can also consider the limit  $T \rightarrow \infty$ . In the recent case one would replace  $\tau$  with the difference  $m_1 - m_2 = m$  of  $M^4$  coordinates of two points at the preferred extremal and integrate over the points of the extremal to get the average. The finite time interval  $T$  is replaced with the volume of causal diamond in a given length scale. Zero energy state with given quantum numbers for positive and negative energy parts of the state defines the initial and final states between which the fields appearing in the correlation functions are defined.
3. What correlation functions should be considered? Certainly one could calculate correlation functions for the induced spinor connection given electro-weak propagators and correlation functions for  $CP_2$  Killing vector fields giving correlation functions for gluon fields using the description in terms of Killing vector fields. If one can uniquely separate from the Fourier transform uniquely a term of form  $Z/(p^2 - m^2)$  by its momentum dependence, the coefficient  $Z$  can be identified as coupling constant squared for the corresponding gauge potential component and one can in principle deduce coupling constant evolution purely classically. One can imagine of calculating spinorial propagators for string world sheets in the same manner. Note that also the dependence on color quantum numbers would be present so that in principle all that is needed could be calculated for a single preferred extremal without the need to construct QFT limit and to introduce color quantum numbers of fermions as spin like quantum numbers (color quantum numbers corresponds to  $CP_2$  partial wave for the tip of the CD assigned with the particle).
4. What about Higgs field? TGD in principle allows scalar and pseudo-scalars which could be called Higgs like states. These states are however not necessary for particle massivation although they can represent particle massivation and must do so if one assumes that QFT limit exist. p-Adic thermodynamics however describes particle massivation microscopically.

The problem is that Higgs like field does not seem to have any obvious space-time correlate. The trace of the second fundamental form is the obvious candidate but vanishes for preferred extremals which are both minimal surfaces and solutions of Einstein Maxwell equations with cosmological constant. If the string world sheets at which all spinor components except right handed neutrino are localized for the general solution ansatz of the modified Dirac equation, the corresponding second fundamental form at the level of imbedding space defines a candidate for classical Higgs field. A natural expectation is that string world sheets are minimal surfaces of space-time surface. In general they are however not minimal surfaces of the imbedding space so that one might achieve a microscopic definition of classical Higgs field and its vacuum expectation value as an average of one point correlation function over the string world sheet.

Many detailed speculations about coupling constant evolution to be discussed in the sections below must be taken as innovative guesses doomed to have the eventual fate of guesses. The notion of quantum ergodicity could however be one of the really deep ideas about coupling constant evolution comparable to the notion of p-adic coupling constant evolution. Quantum Ergodicity (briefly QE) would also state something extremely non-trivial also about the construction of correlation functions and S-matrix. Because this principle is so new, the rest of the chapter does not yet contain any applications of QE. This should not lead the reader to under-estimate the potential power of QE.

## 2.12 Does thermodynamics have a representation at the level of space-time geometry?

R. Kiehn has proposed what he calls Topological Thermodynamics (TTD) [?] as a new formulation of thermodynamics. The basic vision is that thermodynamical equations could be translated to differential geometric statements using the notions of differential forms and Pfaffian system [?]. That TTD differs from TGD by a single letter is not enough to ask whether some relationship between them might exist. Quantum TGD can however in a well-defined sense be regarded as a square root of thermodynamics in zero energy ontology (ZEO) and this leads leads to ask seriously whether TTD might help to understand TGD at deeper level. The thermodynamical interpretation of space-time dynamics would obviously generalize black hole thermodynamics to TGD framework and already earlier some concrete proposals have been made in this direction.

One can raise several questions. Could the preferred extremals of Kähler action code for the square root of thermodynamics? Could induced Kähler gauge potential and Kähler form (essentially Maxwell field) have formal thermodynamic interpretation? The vacuum degeneracy of Kähler action implies 4-D spin glass degeneracy and strongly suggests the failure of strict determinism for the dynamics of Kähler action for non-vacuum extremals too. Could thermodynamical irreversibility and preferred arrow of time allow to characterize the notion of preferred extremal more sharply?

It indeed turns out that one can translate Kiehn's notions to TGD framework rather straightforwardly.

1. Kiehn's work 1- form corresponds to induced Kähler gauge potential implying that the vanishing of instanton density for Kähler form becomes a criterion of reversibility and irreversibility is localized on the (4-D) "lines" of generalized Feynman diagrams, which correspond to space-like signature of the induced metric. The localization of heat production to generalized Feynman diagrams conforms nicely with the kinetic equations of thermodynamics based on reaction rates deduced from quantum mechanics. It also conforms with Kiehn's vision that dissipation involves topology change.
2. Heat produced in a given generalized Feynman diagram is just the integral of instanton density and the condition that the arrow of geometric time has definite sign classically fixes the sign of produced heat to be positive. In this picture the preferred extremals of Kähler action would allow a trinity of interpretations as non-linear Maxwellian dynamics, thermodynamics, and integrable hydrodynamics.
3. The 4-D spin glass degeneracy of TGD breaking of ergodicity suggests that the notion of global thermal equilibrium is too naive. The hierarchies of Planck constants and of p-adic length scales suggests a hierarchical structure based on *CDs* withing *CDs* at imbedding space level and space-time sheets topologically condensed at larger space-time sheets at space-time level. The arrow of geometric time for quantum states could vary for sub-*CDs* and would have thermodynamical space-time correlates realized in terms of distributions of arrows of geometric time for sub-*CDs*, sub-sub-*CDs*, etc...

The hydrodynamical character of classical field equations of TGD means that field equations reduce to local conservation laws for isometry currents and Kähler gauge current. This requires the extension of Kiehn's formalism to include besides forms and exterior derivative also induced metric, index raising operation transforming 1-forms to vector fields, duality operation transforming k- forms to n-k forms, and divergence which vanishes for conserved currents.

### 2.12.1 Motivations and background

It is good to begin by discussing the motivations for the geometrization of thermodynamics and by introducing the existing mathematical framework identifying space-time surfaces as preferred extremals of Kähler action.

#### ZEO and the need for the space-time correlates for square root of thermodynamics

Quantum classical correspondence is basic guiding principle of quantum TGD. In ZEO TGD can be regarded as a complex square root of thermodynamics so that the thermodynamics should have



correlates at the level of the geometry of space-time.

1. Zero energy states consist of pairs of positive and negative energy states assignable to opposite boundaries of a causal diamond ( $CD$ ). There is entire hierarchy of  $CD$ s characterized by their scale coming as an integer multiple of a basic scale (also their Poincare transforms are allowed).
2. In ZEO zero energy states are automatically time-irreversible in the sense that either end of the causal diamond ( $CD$ ) corresponds to a state consisting of single particle states with well-defined quantum numbers. In other words, this end of  $CD$  carries a prepared state. The other end corresponds to a superposition of states which can have even different particle numbers: this is the case in particle physics experiment typically. State function reduction reduces the second end of  $CD$  to a prepared state. This process repeats itself. This suggests that the arrow of time or rather, its geometric counterpart which we experience, alternates. This need not however be the case if quantum classical correspondence holds true.
3. To illustrate what I have in mind consider a path towel, which has been been folded forth and back. Assume that the direction in which folding is carried is time direction. Suppose that the inhabitant of bath towel Universe is like the habitant of the famous Flatland and therefore not able to detect the folding of the towel. If the classical dynamics of towel is time irreversible (time corresponds to the direction in which the folding takes place), the inhabitant sees ever lasting irreversible time evolution with single arrow of geometric time identified as time coordinate for the towel: no changes in the arrow of geometric time. If the inhabitant is able to make measurements about 3-D space the situation he or she might be able to see that his time evolution takes place forth and back with respect to the time coordinate of higher-dimensional imbedding space.
4. One might understand the arrow of time - albeit differently as in normal view about the situation - if classical time evolution for the preferred extremals of Kähler action defines a geometric correlate for quantum irreversibility of zero energy states. There are of course other space-time sheets and other  $CD$ s present and it might be possible to detect the alternation of the arrow of geometric time at imbedding space level by making measurements giving information about their geometric arrows of time [?].

By quantum classical correspondence one expects that the geometric arrow of time - irreversibility - for zero energy states should have classical counterparts at the level of the dynamics of preferred extremals of Kähler action. What could be this counterpart? Thermodynamical evolution by quantum jumps does not obey ordinary variational principle that would make it deterministic: Negentropy Maximization Principle (NMP) [K42] for state function reductions of system is analogous to Second Law for an ensemble of copies of system and actually implies it. Could one mimic irreversibility by single classical evolution defined by a preferred extremal? Note that the dynamics of preferred extremals is not actually strictly deterministic in the ordinary sense of the word: the reason is the enormous vacuum degeneracy implying 4-D spin glass degeneracy. This makes it possible to mimic not only quantum states but also sequences of quantum jumps by piece-wise deterministic evolution.

### Preferred extremals of Kähler action

In Quantum TGD the basic arena of quantum dynamics is "world of classical worlds" (WCW) [K60]. Purely classical spinor fields in this infinite-dimensional space define quantum states of the Universe. General Coordinate Invariance (GCI) implies that classical worlds can be regarded as either 3-surfaces or 4-D space-time surfaces analogous to Bohr orbits. Strong form of GCI implies in ZEO strong form of holography in the sense that the points of WCW effectively correspond to collections of partonic 2-surfaces belonging to both ends of causal diamonds ( $CD$ s) plus their 4-D tangent space-time data.

Kähler geometry reduces to the notion of Kähler function [?] and by quantum classical correspondence a good guess is that Kähler function corresponds to so called Kähler action for Euclidian space-time regions. Minkowskian space-time regions give a purely imaginary to Kähler action (square root of metric determinant is imaginary) and this contribution plays the role of Morse function for WCW. Stationary phase approximation implies that in first the approximation the extremals of the

Kähler *function* (to be distinguished from preferred extremals of Kähler *action*!) select one particular 3-surface and corresponding classical space-time surface (Bohr orbit) as that defining "classical physics".

GCI implies holography and holography suggests that action reduces to 3-D terms. This is true if one has  $j^\mu A_\mu = 0$  in the interior of space-time. If one assumes so called weak form of electric-magnetic duality [?] at the real and effective boundaries of space-time surface (3-D surfaces at the ends of  $CDs$  and the light-like 3-surfaces at which the signature of induced 4-metric changes so that 4-metric is degenerate), one obtains a reduction of Kähler action to Chern-Simons terms at the boundaries. TGD reduces to almost topological QFT. "Almost" means that the induced metric does not disappear completely from the theory since it appears in the conditions expressing weak form of electric magnetic duality and in the condition  $j^\mu A_\mu = 0$ .

The strong form of holography implies effective 2-dimensionality and this suggests the reduction of Chern-Simons terms to 2-dimensional areas of string world sheets and possible of partonic 2-surfaces. This would mean almost reduction to string theory like theory with string tension becoming a dynamic quantity.

Under additional rather general conditions the contributions from Minkowskian and Euclidian regions of space-time surface are apart from the value of coefficient identical at light-like 3-surfaces. At space-like 3-surfaces at the ends of space-time surface they need not be identical.

Quantum classical correspondence suggests that space-time surfaces provide a representation for the square root of thermodynamics and therefore also for thermodynamics. In general relativity black hole thermodynamics suggests the same. This idea is not new in TGD framework. For instance, Hawking-Bekenstein formula for blackbody entropy [?] allows a p-adic generalization in terms of area of partonic 2-surfaces [?]. The challenge is to deduce precise form of this correspondence and here Kiehn's topological thermodynamics might help in this task.

### 2.12.2 Kiehn's topological thermodynamics (TTD)

The basic in the work of Kiehn is that thermodynamics allows a topological formulation in terms of differential geometry.

1. Kiehn introduces also the notions of <http://www22.pair.com/csdc/pdf/irevtors.pdf> Pfaff system and Pfaff dimension as the number of non-vanishing forms in the sequence for given 1-form such as  $W$  or  $Q$ :  $W, dW, W \wedge dW, dW \wedge dW$ . Pfaff dimension  $D \leq 4$  tells that one can describe  $W$  as sum  $W = \sum W_k dx^k$  of gradients of  $D$  variables.  $D = 4$  corresponds to open system,  $D = 3$  to a closed system and  $W \wedge dW \neq 0$  defines what can be regarded as a chirality. For  $D = 2$  chirality vanishes no spontaneous parity breaking.
2. Kiehn's king idea that Pfaffian systems provide a universal description of thermodynamical reversibility. Kiehn introduces heat 1- form  $Q$ . System is thermodynamically reversible if  $Q$  is integrable. In other words, the condition  $Q \wedge dQ = 0$  holds true which implies that one can write  $Q = TdS$ :  $Q$  allows an integrable factor  $T$  and is expressible in terms of the gradient of entropy.  $Q = TdS$  condition implies that  $Q$  correspond to a global flow defined by the coordinate lines of  $S$ . This in turn implies that it is possible define phase factors depending on  $S$  along the flow line: this relates to macroscopic quantum coherence for macroscopic quantum phases.
3. The first law expressing the work 1-form  $W$  as  $W = Q - dU = TdS - dU$  for reversible processes. This gives  $dW \wedge dW = 0$ . The condition  $dW \wedge dW \neq 0$  therefore characterizes irreversible processes.
4. Symplectic transformations are natural in Kiehn's framework but not absolutely essential.

Reader is encouraged to get familiar with Kiehn's examples [?] about the description of various simple thermodynamical systems in this conceptual framework. Kiehn has also worked with the differential topology of electrodynamics and discussed concepts like integrable flows known as Beltrami flows. These flows generalized to TGD framework and are in key role in the construction of proposals for preferred extremals of Kähler action: the basic idea would be that various conserved isometry currents define Beltrami flows so that their flow lines can be associated with coordinate lines.

### 2.12.3 Attempt to identify TTD in TGD framework

Let us now try to identify TTD or its complex square root in TGD framework.

#### The role of symplectic transformations

Symplectic transformations are important in Kiehn's approach although they are not a necessary ingredient of it and actually impossible to realize in Minkowski space-time.

1. Symplectic symmetries of WCW induced by symplectic symmetries of  $CP_2$  and light-like boundary of  $CD$  are important also in TGD framework [?] and define the isometries of WCW. As a matter of fact, symplectic group parameterizes the quantum fluctuating degrees of freedom and zero modes defining classical variables are symplectic invariants. One cannot assign to entire space-time surfaces symplectic structure although this is possible for partonic 2-surfaces.
2. The symplectic transformations of  $CP_2$  act on the Kähler gauge potential as  $U(1)$  gauge transformations formally but modify the shape of the space-time surface. These symplectic transformations are symmetries of Kähler action only in the vacuum sector which as such does not belong to WCW whereas small deformations of vacua belong. Therefore genuine gauge symmetries are not in question. One can of course formally assign to Kähler gauge potential a separate  $U(1)$  gauge invariance.
3. Vacuum extremals with at most 2-D  $CP_2$  projection (Lagrangian sub-manifold) form an infinite-dimensional space. Both  $M^4$  diffeomorphisms and symplectic transformations of  $CP_2$  produce new vacuum extremals, whose small deformations are expected to correspond preferred extremals. This gives rise to 4-D spin glass degeneracy [?] to be distinguished from 4-D gauge degeneracy.

#### Identification of basic 1-forms of TTD in TGD framework

Consider next the identification of the basic variables which are forms of various degrees in TTD.

1. Kähler gauge potential is analogous to work 1-form  $W$ . In classical electrodynamics vector potential indeed has this interpretation.  $dW \wedge dW$  is replaced with  $J \wedge J$  defining instanton density ( $E_K \cdot B_K$  in physicist's notation) for Kähler form and its non-vanishing - or equivalently 4-dimensionality of  $CP_2$  projection of space-time surface - would be the signature of irreversibility.  $dJ = 0$  holds true only locally and one can have magnetic monopoles since  $CP_2$  has non-trivial homology. Therefore the non-trivial topology of  $CP_2$  implying that the counterpart of  $W$  is not globally defined, brings in non-trivial new element to Kiehn's theory.
2. Chirality  $C - S = A \wedge J$  is essentially Chern-Simons 3-form and in ordinary QFT non-vanishing of  $C - S$  if present in action - means parity breaking in ordinary quantum field theories. Now one must be very cautious since parity is a symmetry of the imbedding space rather than that of space-time sheet.
3. Pfaff dimension equals to the dimension of  $CP_2$  projection and has been used to classify existing preferred extremals. I have called the extremals with 4-D  $CP_2$  projection chaotic and so called  $CP_2$  vacuum extremals with 4-D  $CP_2$  projection correspond to such extremals. Massless extremals or topological light rays correspond to  $D = 2$  as do also cosmic strings. In Euclidian regions preferred extremals with  $D = 4$  are possible but not in Minkowskian regions if one accepts effective 3-dimensionality. Here one must keep mind open.

Irreversibility identified as a non-vanishing of the instanton density  $J \wedge J$  has a purely geometrical and topological description in TGD Universe if one accepts effective 3-dimensionality.

1. The effective 3-dimensionality for space-time sheets (holography implied by general coordinate invariance) implies that Kähler action reduces to Chern-Simons terms so that the Pfaff dimension is at most  $D = 3$  for Minkowskian regions of space-time surface so that they are thermodynamically reversible.

2. For Euclidian regions (say deformations of  $CP_2$  type vacuum extremals) representing orbits of elementary particles and lines of generalized Feynman diagrams  $D = 4$  is possible. Therefore Euclidian space-like regions of space-time would be solely responsible for the irreversibility. This is quite strong conclusion but conforms with the standard quantum view about thermodynamics according to which various particle reaction rates deduced from quantum theory appear in kinetic equations giving rise to irreversible dynamics at the level of ensembles. The presence of Morse function coming from Minkowskian regions is natural since square root of thermodynamics is in question. Morse function is analogous to the action in QFTs whereas Kähler function is analogous to Hamiltonian in thermodynamics. Also this conforms with the square root of TTD interpretation.

### Instanton current, instanton density, and irreversibility

Classical TGD has the structure of hydrodynamics in the sense that field equations are conservation laws for isometry currents and Kähler current. These are vector fields although induced metric allows to transform them to forms. This aspect should be visible also in thermodynamic interpretation and forces to add to the Kiehn's formulation involving only forms and exterior derivative also induced metric transforming 1-forms to vector fields, the duality mapping 4-k forms and k-forms to each other, and divergence operation.

It was already found that irreversibility and dissipation corresponds locally to a non-vanishing instanton density  $J \wedge J$ . This form can be regarded as exterior derivative of Chern-Simons 3-form or equivalently as divergence of instanton current.

1. The dual of C-S 3-form given by  $*(A \wedge J)$  defines what I have called instanton current. This current is not conserved in general and the interpretation as a heat current would be natural. The exterior derivative of C-S gives instanton density  $J \wedge J$ . Equivalently, the divergence of instanton current gives the dual of  $J \wedge J$  and the integral of instanton density gives the analog of instanton number analogous to the heat generated in a given space-time volume. Note that in Minkowskian regions one can multiply instanton current with a function of  $CP_2$  coordinates without losing closedness property so that infinite number similar conserved currents is possible. The heat 3-form is expressible in terms of Chern-Simons 3-form and for preferred extremals it would be proportional to the weight sum of Kähler actions from Minkowskian and Euclidian regions (coefficients are purely imaginary and real in these two regions). Instead of single real quantity one would have complex quantity characterizing irreversibility. Complexity would conform with the idea that quantum TGD is complex square root of thermodynamics.
2. The integral of heat 3-form over effective boundaries associated with a given space-time region define the net heat flow from that region. Only the regions defining the lines of generalized Feynman diagrams give rise to non-vanishing heat fluxes. Second law states that one has  $\Delta Q \geq 0$ . Generalized second law means at the level of quantum classical correspondence would mean that depending on the arrow of geometric time for zero energy state  $\Delta Q$  is defined as difference between upper and lower or lower and upper boundaries of  $CD$ . This condition applied to  $CD$  and sub- $CD$ :s would generalize the conditions familiar from hydrodynamics (stating for instance that for shock waves the branch of bifurcation for which the entropy increases is selected). Note that the field equations of TGD are hydrodynamical in the sense that they express conservation of various isometry currents. The naive picture about irreversibility is that classical dynamics generates  $CP_2$  type vacuum extremals so that the number of outgoing lines of generalized Feynman diagram is higher than that of incoming ones. Therefore that the number of space-like 3-surfaces giving rise to Chern-Simons contribution is larger at the end of  $CD$  corresponding to the final (negative energy) state.
3. A more precise characterization of the irreversible states involves several non-trivial questions.
  - (a) By the failure of strict classical determinism the condition that for a given  $CD$  the number outgoing lines is not smaller than incoming lines need not provide a unique manner to fix the preferred extremal when partonic 2-surfaces at the ends are fixed. Could the arrow of geometric time depend on sub- $CD$  as the model for living matter suggests (recall also phase conjugate light rays)?

In ordinary quantum mechanical approach to kinetic equations also the reactions, which decrease entropy are allowed but their weight is smaller in thermal equilibrium. Could this fact be described as a probability distribution for the arrow of time associated for the sub-*CDs*, sub-sub-*CDs*, etc... ? Space-time correlates for quantal thermodynamics would be probability distributions for space-time sheets and hierarchy of sub-*CDs*.

- (b) 4-D spin glass degeneracy suggests breaking of ergodic hypothesis: could this mean that one does not have thermodynamical equilibrium but very large number of spin glass states caused by the frustration for which induced Kähler form provides a representation? Could these states correspond to a varying arrow of geometric time for sub-*CDs*? Or could different deformed vacuum extremals correspond to different space-time sheets in thermal equilibrium with different thermal parameters.

**Also Kähler current and isometry currents are needed**

The conservation Kähler current and of isometry currents imply the hydrodynamical character of TGD.

1. The conserved Kähler current  $j_K$  is defined as 3-form  $j_K = *(d * J)$ , where  $d * J$  is closed 3-form and defines the counterpart of  $d*dW$ . Field equations for preferred extremals require  $*j_K \wedge A = 0$  satisfied if one Kähler current is proportional to instanton current:  $*j_K \propto A \wedge J$ . As a consequence Kähler action reduces to 3-dimensional Chern-Simons terms (classical holography) and Minkowskian space-time regions have at most 3-D  $CP_2$  projection (Pfaff dimension  $D \leq 3$ ) so that one has  $J \wedge J = 0$  and reversibility. This condition holds true for preferred extremals representing macroscopically the propagation of massless quanta but not Euclidian regions representing quanta themselves and identifiable as basic building bricks of wormhole contacts between Minkowskian space-time sheets.
2. A more general proposal is that all conserved currents transformed to 1-forms using the induced metric (classical gravitation comes into play!) are integrable: in other words, one has  $j \wedge dj = 0$  for both isometry currents and Kähler current. This would mean that they are analogous to heat 1-forms in the reversible case and therefore have a representation analogous to  $Q = TdS$ ,  $W = PdV$ ,  $\mu dN$  and the coordinate along flowline defines the analog of  $S$ ,  $V$ , or  $N$  (note however that  $dS, dV, dN$  would more naturally correspond to 3-forms than 1-forms, see below) A stronger form corresponds to the analog of hydrodynamics for one particle species: all one-forms are proportional (by scalar function) to single 1-form which is  $A \wedge J$  (all quantum number flows are parallel to each other).

**Questions**

There are several questions to be answered.

1. In Darboux coordinates in which one has  $A = P_1 dQ^1 + P_2 dQ^2$ . The identification of  $A$  as counterpart for  $W = PdV - \mu dN$  comes first in mind. For thermodynamical equilibria one would have  $TdS = dU + W$  translating to  $TdS = dU + A$  so that  $Q$  for reversible processes would be apart from  $U(1)$  gauge transformation equal to the Kähler gauge potential. Symplectic transformations of  $CP_2$  generate  $U(1)$  gauge transformations and  $dU$  might have interpretation in terms of energy flow induced by this kind of transformation. Recall however that symplectic transformations are not symmetries of space-time surfaces but only of the WCW metric and act on partonic 2-surfaces and their tangent space data as such.
2. Does the conserved Kähler current  $j_K$  have any thermodynamical interpretation? Clearly the counterparts of conserved (and also non-conserved quantities) in Kiehn's formulation would be 3-forms with vanishing curl  $d(*j_K) = 0$  in conserved case. Therefore it seems impossible to reduce them to 1-forms unless one introduces divergence besides exterior derivative as a basic differential operation.

The hypothesis that the flow lines of these 1-forms associated with  $j_K$  vector field are integrable implies that they are gradients apart from the presence of integrating factor. Reduction to a gradient ( $j = dU$ ) means that  $U$  satisfies massless d'Alembert equation  $d * dU = 0$ . Note

that local polarization and light-like momentum are gradients of scalar functions which satisfy massless d'Alembert equation for the Mikowskian space-time regions representing propagating of massless quanta.

3. In genuinely 3-dimensional context  $S, V, N$  are integrals of 3-forms over 3-surfaces for some current defining 3-form. This is in conflict with Kiehn's description where they are 0-forms. One can imagine three cures and first two ones look
  - (a) The integrability of the flows allows to see them as superposition of independent 1-dimensional flows. This picture would make it natural to regard the TGD counterparts of  $S, V, N$  as 0-forms rather than 2-forms. This would also allow to deduce  $J \wedge J = 0$  as a reversibility condition using Kiehn's argument.
  - (b) Unless one requires integrable flows, one must consider the replacement of  $Q = TdS$  resp.  $W = PdV$  resp.  $\mu dN$   $Q = TdS$  resp.  $W = PdV$  resp.  $\mu dN$  where  $W, Q, dS, dV, \text{ and } dN$  with 3-forms. So that  $S, V, N$  would be 2-forms and the 3-integrals of  $dS, dV, dN$  over 3-surfaces would reduce to integrals over partonic 2-surfaces, which is of course highly non-trivial but physically natural implication of the effective 2-dimensionality. First law should now read as  $*W = T*dS - *dU$  and would give  $d*W = dT \wedge *dS + Td*dS + d*dU$ . If  $S$  and  $U$  as 2-forms satisfy massless d'Alembert equation, one obtains  $d*W = dT \wedge *dS$  giving  $d*W \wedge d*W = 0$  as the reversibility condition. If one replaces  $W \leftrightarrow A$  correspondence with  $*W \leftrightarrow A$  correspondence, one obtains the vanishing of instanton density as a condition for reversibility. For the preferred extremals having interpretation as massless modes the massless d'Alembert equations are satisfied and it might that this option makes sense and be equivalent with the first option.
  - (c) In accordance with the idea that finite measurement resolution is realized at the level of modified Dirac equation, its solutions at lightlike 3-surfaces reduces to solutions restricted to lines connecting partonic 2-surfaces. Could one regard  $W, Q, dS, dV, \text{ and } dN$  as singular one-forms restricted to these lines? The vanishing of instanton density would be obtained as a condition for reversibility only at the braid strands, and one could keep the original view of Kiehn. Note however that the instanton density could be non-vanishing elsewhere unless one develops a separate argument for its vanishing. For instance, the condition that isometries of imbedding space say translations produce braid ends points for which instanton density also vanishes for the reversible situation might be enough.

To sum up, it seems that TTD allows to develop considerable insights about how classical space-time surfaces could code for classical thermodynamics. An essential ingredient seems to be the reduction of the hydrodynamical flows for isometry currents to what might be called perfect flows decomposing to 1-dimensional flows with conservation laws holding true for individual flow lines. An interesting challenge is to find expressions for total heat in terms of temperature and entropy. Blackhole-elementary particle analogy suggest the reduction as well as effective 2-dimensionality suggest the reduction of the integrals of Chern-Simons terms defining total heat flux to two 2-D volume integrals over string world sheets and/or partonic 2-surfaces and this would be quite near to Hawking-Bekenstein formula.

# Mathematics

- [A1] Gaussian Mersenne. <http://primes.utm.edu/glossary/xpage/GaussianMersenne.html>.
- [A2] Z. I. Borevich and I. R. Shafarevich. *Number Theory*. Academic Press, 1966.
- [A3] Eisenhart. *Riemannian Geometry*. Princeton University Press, 1964.
- [A4] C. N. Pope G. W. Gibbons.  $CP_2$  as gravitational instanton. *Comm. Math. Phys.*, 55, 1977.
- [A5] W. Hawking, S. and N. Pope, C. Generalized Spin Structures in Quantum Gravity. *Phys. Lett.*, (1), 1978.
- [A6] S. Helgason. *Differential Geometry and Symmetric Spaces*. Academic Press, New York, 1962.
- [A7] C. Itzykson and J-B. Zuber. *Quantum Field Theory*, volume 549. Mc Graw-Hill, New York, 1980.
- [A8] J. Milnor. *Topology form Differential Point of View*. The University Press of Virginia, Virginia, 1965.
- [A9] D. S. Moak. The q-analogue of the Laguerre polynomials. *J. Math. Anal. Appl.*, 81, 1981.
- [A10] N. Pope, C. Eigenfunctions and  $Spin^c$  Structures on  $CP_2$ , 1980.
- [A11] B. Shipman. The geometry of momentum mappings on generalized flag manifolds, connections with a dynamical system, quantum mechanics and the dance of honeybee. <http://math.cornell.edu/~oliver/Shipman.gif>, 1998.
- [A12] M. Spivak. *Differential Geometry I,II,III,IV*. Publish or Perish, Boston, 1970.
- [A13] J. Hanson T. Eguchi, B. Gilkey. *Phys. Rep.*, 66:1980, 1980.
- [A14] R. Thom. *Commentarii Math. Helvet.*, 28, 1954.
- [A15] Wallace. *Differential Topology*. W. A. Benjamin, New York, 1968.
- [A16] E. C. Zeeman. *Catastrophe Theory*. Addison-Wessley Publishing Company, 1977.





# Theoretical Physics

- [B1] J. Björken and S. Drell. *Relativistic Quantum Fields*. Mc Graw-Hill, New York, 1965.
- [B2] K. Huang. *Quarks, Leptons & Gauge Fields*. World Scientific, 1982.
- [B3] R. Kiehn. Electromagnetic waves in vacuum with torsion and spin. <http://www22.pair.com/csdc/pdf/helical6.pdf>.
- [B4] G. Parisi. *Field Theory, Disorder and Simulations*. World Scientific, 1992.
- [B5] A. Zee. *The Unity of Forces in the Universe*. World Science Press, Singapore, 1982.



# Condensed Matter Physics

- [D1] Fractional quantum Hall Effect. [http://en.wikipedia.org/wiki/Fractional\\_quantum\\_Hall\\_effect](http://en.wikipedia.org/wiki/Fractional_quantum_Hall_effect).
- [D2] Hydrogen bonds. [http://en.wikipedia.org/wiki/Hydrogen\\_bond](http://en.wikipedia.org/wiki/Hydrogen_bond).
- [D3] Phase conjugation. <http://www.usc.edu/dept/ee/People/Faculty/feinberg.html>.
- [D4] O. Balcou and L. Durtriaux. *Phys. Rev.*, 78, 1997.
- [D5] J. K. Borhardt. The chemical formula H<sub>2</sub>O - a misnomer. *The Alchemist*, August 2003.
- [D6] M. Chaplin. Water Structure and Behavior. <http://www.lsbu.ac.uk/water/index.html>, 2005.
- [D7] R. Y. Chiao. Super-conductors as transducers and antennas for gravitational and electromagnetic radiation. <http://arxiv.org/abs/gr-gc/0204012>.
- [D8] R. Y. Chiao. Tunnelling Times and Super-luminality: a Tutorial, November 1998.
- [D9] R. Y. Chiao and A. M. Steinberg. In E. Wolf, editor, *Progress in Optics XXXVII*, volume 345, Amsterdam, 1997. Elsevier.
- [D10] R. A. Cowley. Neutron-scattering experiments and quantum entanglement. *Physica B*, 350:243–245, 2004.
- [D11] D. J. Evans et al. Experimental Demonstration of Violations of the Second Law of Thermodynamics for Small Systems and Short Time Scales. *Phys. Rev.*, 89, 2002.
- [D12] G. A. Melkov et al. *Phase Conjugation of Linear and Nonlinear Signals of Magnetostatic Waves*. Trans Tech Publications, Switzerland, 2001.
- [D13] G. Nimtz et al. *J. Phys.*, 4, 1994.
- [D14] J. B. Miller et al. Fractional Quantum Hall effect in a quantum point contact at filling fraction  $5/2$ . <http://arxiv.org/abs/cond-mat/0703161v2>, 2007.
- [D15] R. Mills et al. Spectroscopic and NMR identification of novel hybrid ions in fractional quantum energy states formed by an exothermic reaction of atomic hydrogen with certain catalysts. <http://www.blacklightpower.com/techpapers.html>, 2003.
- [D16] S. M. Girvin. Quantum Hall Effect, Novel Excitations and Broken Symmetries. <http://arxiv.org/abs/cond-mat/9907002>, 1999.
- [D17] J.K. Jain. *Phys. Rev.*, 63, 1989.
- [D18] P. Kanarev. Water is New Source of Energy. *Krasnodar*, 2002.
- [D19] P. Kanarev and T. Mizuno. Cold fusion by plasma electrolysis of water. <http://www.guns.connect.fi/innoplaza/energy/story/Kanarev/codlfusion/>, 2002.
- [D20] I. Langmuir. *Journal of American Chemical Society*, 37, 1915.
- [D21] R. B. Laughlin. *Phys. Rev.*, 50, 1990.

- [D22] J-C. Li and D.K. Ross. Evidence of Two Kinds of Hydrogen Bonds in Ices. *Nature*, 365:327–329, 1993.
- [D23] R. Mackenzie and F. Wilczek. *Rev. Mod. Phys. A*, 3:2827, 1988.
- [D24] S. Meyer. Water Fuel Cell. International News Release, No. 11 A-Rv., 1996.
- [D25] D. M. Pepper. Nonlinear Optical Phase Conjugation. *Optical Engineering*, 21(2), March 1982.
- [D26] H. Puthoff. Ground State of Hydrogen as a Zero-Point Fluctuation Determined State. *Phys. Rev. D*, 35, 1987.
- [D27] Y. Danon R. Moreh, R. C. Block and M. Neumann. Search for anomalous scattering of keV neutrons from H<sub>2</sub>O-D<sub>2</sub>O mixtures. *Phys. Rev.*, 94, 2005.
- [D28] V. V. Shkunov and B. Ya. Zeldovich. Optical Phase Conjugation. *Scientific American*, 1985.
- [D29] D. D. Stancil. *Theory of Magnetostatic Waves*. Springer Verlag, 1993.
- [D30] A. M. Steinberg and R. Y. Chiao. Sub-femtosecond determination of transmission delay times for a dielectric mirror (photonic bandgap) as a function of angle of incidence. <http://arxiv.org/abs/quant-ph/9501013>, 1995.
- [D31] L. Wang. *Nature*, July 2000.
- [D32] Pollack G. Zheng, Jian-ming. Long-range forces extending from polymer-gel surfaces. <http://arxiv.org/abs/cond-mat/0305093>, 2003.

# Books related to TGD

- [K1] M. Pitkänen. 1983.
- [K2] M. Pitkänen. Is it Possible to Understand Coupling Constant Evolution at Space-Time Level? In *Towards M-Matrix*. Onlinebook. [http://tgdtheory.com/public\\_html/tgdquant/tgdquant.html#rgflow](http://tgdtheory.com/public_html/tgdquant/tgdquant.html#rgflow), 2006.
- [K3] M. Pitkänen. About Strange Effects Related to Rotating Magnetic Systems . In *TGD and Fringe Physics*. Onlinebook. [http://tgdtheory.com/public\\_html/freenergy/freenergy.html#Faraday](http://tgdtheory.com/public_html/freenergy/freenergy.html#Faraday), 2006.
- [K4] M. Pitkänen. About the New Physics Behind Qualia. In *Quantum Hardware of Living Matter*. Onlinebook. [http://tgdtheory.com/public\\_html/bioware/bioware.html#newphys](http://tgdtheory.com/public_html/bioware/bioware.html#newphys), 2006.
- [K5] M. Pitkänen. An Overview about Quantum TGD: Part I. In *Topological Geometrodynamics: Overview*. Onlinebook. [http://tgdtheory.com/public\\_html/tgdview/tgdview.html#evoII](http://tgdtheory.com/public_html/tgdview/tgdview.html#evoII), 2006.
- [K6] M. Pitkänen. An Overview about the Evolution of Quantum TGD. In *Topological Geometrodynamics: Overview*. Onlinebook. [http://tgdtheory.com/public\\_html/tgdview/tgdview.html#evoI](http://tgdtheory.com/public_html/tgdview/tgdview.html#evoI), 2006.
- [K7] M. Pitkänen. Anomalies Related to the Classical  $Z^0$  Force and Gravitation. In *TGD and Fringe Physics*. Onlinebook. [http://tgdtheory.com/public\\_html/freenergy/freenergy.html#Zanom](http://tgdtheory.com/public_html/freenergy/freenergy.html#Zanom), 2006.
- [K8] M. Pitkänen. Appendix A: Quantum Groups and Related Structures. In *Towards M-Matrix*. Onlinebook. [http://tgdtheory.com/public\\_html/tgdquant/tgdquant.html#bialgebra](http://tgdtheory.com/public_html/tgdquant/tgdquant.html#bialgebra), 2006.
- [K9] M. Pitkänen. Basic Extremals of Kähler Action. In *Physics in Many-Sheeted Space-Time*. Onlinebook. [http://tgdtheory.com/public\\_html/tgdclass/tgdclass.html#class](http://tgdtheory.com/public_html/tgdclass/tgdclass.html#class), 2006.
- [K10] M. Pitkänen. *Bio-Systems as Conscious Holograms*. Onlinebook. [http://tgdtheory.com/public\\_html/hologram/hologram.html](http://tgdtheory.com/public_html/hologram/hologram.html), 2006.
- [K11] M. Pitkänen. Bio-Systems as Conscious Holograms. In *Bio-Systems as Conscious Holograms*. Onlinebook. [http://tgdtheory.com/public\\_html/hologram/hologram.html#hologram](http://tgdtheory.com/public_html/hologram/hologram.html#hologram), 2006.
- [K12] M. Pitkänen. *Bio-Systems as Self-Organizing Quantum Systems*. Onlinebook. [http://tgdtheory.com/public\\_html/bioselforg/bioselforg.html](http://tgdtheory.com/public_html/bioselforg/bioselforg.html), 2006.
- [K13] M. Pitkänen. Bio-Systems as Super-Conductors: part I. In *Quantum Hardware of Living Matter*. Onlinebook. [http://tgdtheory.com/public\\_html/bioware/bioware.html#superc1](http://tgdtheory.com/public_html/bioware/bioware.html#superc1), 2006.
- [K14] M. Pitkänen. Bio-Systems as Super-Conductors: part II. In *Quantum Hardware of Living Matter*. Onlinebook. [http://tgdtheory.com/public\\_html/bioware/bioware.html#superc2](http://tgdtheory.com/public_html/bioware/bioware.html#superc2), 2006.
- [K15] M. Pitkänen. Configuration Space Spinor Structure. In *Quantum Physics as Infinite-Dimensional Geometry*. Onlinebook. [http://tgdtheory.com/public\\_html/tgdgeom/tgdgeom.html#cspin](http://tgdtheory.com/public_html/tgdgeom/tgdgeom.html#cspin), 2006.

- [K16] M. Pitkänen. Construction of elementary particle vacuum functionals. In *p-Adic Length Scale Hypothesis and Dark Matter Hierarchy*. Onlinebook. [http://tgdtheory.com/public\\_html/paddark/paddark.html#elvafu](http://tgdtheory.com/public_html/paddark/paddark.html#elvafu), 2006.
- [K17] M. Pitkänen. Construction of Quantum Theory: M-matrix. In *Towards M-Matrix*. Onlinebook. [http://tgdtheory.com/public\\_html/tgdquant/tgdquant.html#towards](http://tgdtheory.com/public_html/tgdquant/tgdquant.html#towards), 2006.
- [K18] M. Pitkänen. Cosmic Strings. In *Physics in Many-Sheeted Space-Time*. Onlinebook. [http://tgdtheory.com/public\\_html/tgdclass/tgdclass.html#cstrings](http://tgdtheory.com/public_html/tgdclass/tgdclass.html#cstrings), 2006.
- [K19] M. Pitkänen. Crop Circles and Life at Parallel Space-Time Sheets. In *Magnetospheric Consciousness*. Onlinebook. [http://tgdtheory.com/public\\_html/magnconsc/magnconsc.html#crop1](http://tgdtheory.com/public_html/magnconsc/magnconsc.html#crop1), 2006.
- [K20] M. Pitkänen. Crop Circles and Life at Parallel Space-Time Sheets. In *Magnetospheric Consciousness*. Onlinebook. [http://tgdtheory.com/public\\_html/magnconsc/magnconsc.html#crop2](http://tgdtheory.com/public_html/magnconsc/magnconsc.html#crop2), 2006.
- [K21] M. Pitkänen. Dark Forces and Living Matter. In *p-Adic Length Scale Hypothesis and Dark Matter Hierarchy*. Onlinebook. [http://tgdtheory.com/public\\_html/paddark/paddark.html#darkforces](http://tgdtheory.com/public_html/paddark/paddark.html#darkforces), 2006.
- [K22] M. Pitkänen. Dark Matter Hierarchy and Hierarchy of EEGs. In *TGD and EEG*. Onlinebook. [http://tgdtheory.com/public\\_html/tgdeeg/tgdeeg.html#eegdark](http://tgdtheory.com/public_html/tgdeeg/tgdeeg.html#eegdark), 2006.
- [K23] M. Pitkänen. Dark Nuclear Physics and Condensed Matter. In *p-Adic Length Scale Hypothesis and Dark Matter Hierarchy*. Onlinebook. [http://tgdtheory.com/public\\_html/paddark/paddark.html#exonuclear](http://tgdtheory.com/public_html/paddark/paddark.html#exonuclear), 2006.
- [K24] M. Pitkänen. DNA as Topological Quantum Computer. In *Genes and Memes*. Onlinebook. [http://tgdtheory.com/public\\_html/genememe/genememe.html#dnatqc](http://tgdtheory.com/public_html/genememe/genememe.html#dnatqc), 2006.
- [K25] M. Pitkänen. Does TGD Predict the Spectrum of Planck Constants? In *Towards M-Matrix*. Onlinebook. [http://tgdtheory.com/public\\_html/tgdquant/tgdquant.html#Planck](http://tgdtheory.com/public_html/tgdquant/tgdquant.html#Planck), 2006.
- [K26] M. Pitkänen. Evolution in Many-Sheeted Space-Time. In *Genes and Memes*. Onlinebook. [http://tgdtheory.com/public\\_html/genememe/genememe.html#prebio](http://tgdtheory.com/public_html/genememe/genememe.html#prebio), 2006.
- [K27] M. Pitkänen. General Ideas about Many-Sheeted Space-Time: Part I. In *Physics in Many-Sheeted Space-Time*. Onlinebook. [http://tgdtheory.com/public\\_html/tgdclass/tgdclass.html#topcond](http://tgdtheory.com/public_html/tgdclass/tgdclass.html#topcond), 2006.
- [K28] M. Pitkänen. General Theory of Qualia. In *Bio-Systems as Conscious Holograms*. Onlinebook. [http://tgdtheory.com/public\\_html/hologram/hologram.html#qualia](http://tgdtheory.com/public_html/hologram/hologram.html#qualia), 2006.
- [K29] M. Pitkänen. *Genes and Memes*. Onlinebook. [http://tgdtheory.com/public\\_html/genememe/genememe.html](http://tgdtheory.com/public_html/genememe/genememe.html), 2006.
- [K30] M. Pitkänen. Genes and Memes. In *Genes and Memes*. Onlinebook. [http://tgdtheory.com/public\\_html/genememe/genememe.html#genememec](http://tgdtheory.com/public_html/genememe/genememe.html#genememec), 2006.
- [K31] M. Pitkänen. Homeopathy in Many-Sheeted Space-Time. In *Bio-Systems as Conscious Holograms*. Onlinebook. [http://tgdtheory.com/public\\_html/hologram/hologram.html#homeoc](http://tgdtheory.com/public_html/hologram/hologram.html#homeoc), 2006.
- [K32] M. Pitkänen. Macro-Temporal Quantum Coherence and Spin Glass Degeneracy. In *Bio-Systems as Conscious Holograms*. Onlinebook. [http://tgdtheory.com/public\\_html/hologram/hologram.html#macro](http://tgdtheory.com/public_html/hologram/hologram.html#macro), 2006.
- [K33] M. Pitkänen. Macroscopic Quantum Coherence and Quantum Metabolism as Different Sides of the Same Coin. In *Bio-Systems as Conscious Holograms*. Onlinebook. [http://tgdtheory.com/public\\_html/hologram/hologram.html#metab](http://tgdtheory.com/public_html/hologram/hologram.html#metab), 2006.

- [K34] M. Pitkänen. Macroscopic Quantum Phenomena and  $CP_2$  Geometry. In *Physics in Many-Sheeted Space-Time*. Onlinebook. [http://tgdtheory.com/public\\_html/tgdclass/tgdclass.html#super](http://tgdtheory.com/public_html/tgdclass/tgdclass.html#super), 2006.
- [K35] M. Pitkänen. Magnetic Sensory Canvas Hypothesis. In *TGD and EEG*. Onlinebook. [http://tgdtheory.com/public\\_html//tgdeeg/tgdeeg/tgdeeg.html#mec](http://tgdtheory.com/public_html//tgdeeg/tgdeeg/tgdeeg.html#mec), 2006.
- [K36] M. Pitkänen. *Magnetospheric Consciousness*. Onlinebook. [http://tgdtheory.com/public\\_html/magnconsc/magnconsc.html](http://tgdtheory.com/public_html/magnconsc/magnconsc.html), 2006.
- [K37] M. Pitkänen. Magnetospheric Sensory Representations. In *Magnetospheric Consciousness*. Onlinebook. [http://tgdtheory.com/public\\_html/magnconsc/magnconsc.html#srepre](http://tgdtheory.com/public_html/magnconsc/magnconsc.html#srepre), 2006.
- [K38] M. Pitkänen. Many-Sheeted DNA. In *Genes and Memes*. Onlinebook. [http://tgdtheory.com/public\\_html/genememe/genememe.html#genecodec](http://tgdtheory.com/public_html/genememe/genememe.html#genecodec), 2006.
- [K39] M. Pitkänen. Massless states and particle massivation. In *p-Adic Length Scale Hypothesis and Dark Matter Hierarchy*. Onlinebook. [http://tgdtheory.com/public\\_html/paddark/paddark.html#mless](http://tgdtheory.com/public_html/paddark/paddark.html#mless), 2006.
- [K40] M. Pitkänen. *Mathematical Aspects of Consciousness Theory*. Onlinebook. [http://tgdtheory.com/public\\_html/mathconsc/mathconsc.html](http://tgdtheory.com/public_html/mathconsc/mathconsc.html), 2006.
- [K41] M. Pitkänen. Matter, Mind, Quantum. In *TGD Inspired Theory of Consciousness*. Onlinebook. [http://tgdtheory.com/public\\_html/tgdconsc/tgdconsc.html#conscic](http://tgdtheory.com/public_html/tgdconsc/tgdconsc.html#conscic), 2006.
- [K42] M. Pitkänen. Negentropy Maximization Principle. In *TGD Inspired Theory of Consciousness*. Onlinebook. [http://tgdtheory.com/public\\_html/tgdconsc/tgdconsc.html#nmpc](http://tgdtheory.com/public_html/tgdconsc/tgdconsc.html#nmpc), 2006.
- [K43] M. Pitkänen. New Particle Physics Predicted by TGD: Part I. In *p-Adic Length Scale Hypothesis and Dark Matter Hierarchy*. Onlinebook. [http://tgdtheory.com/public\\_html/paddark/paddark.html#mass4](http://tgdtheory.com/public_html/paddark/paddark.html#mass4), 2006.
- [K44] M. Pitkänen. Nuclear String Hypothesis. In *p-Adic Length Scale Hypothesis and Dark Matter Hierarchy*. Onlinebook. [http://tgdtheory.com/public\\_html/paddark/paddark.html#nuclstring](http://tgdtheory.com/public_html/paddark/paddark.html#nuclstring), 2006.
- [K45] M. Pitkänen. *p-Adic length Scale Hypothesis and Dark Matter Hierarchy*. Onlinebook. [http://tgdtheory.com/public\\_html/paddark/paddark.html](http://tgdtheory.com/public_html/paddark/paddark.html), 2006.
- [K46] M. Pitkänen. p-Adic Particle Massivation: Hadron Masses. In *p-Adic Length Scale Hypothesis and Dark Matter Hierarchy*. Onlinebook. [http://tgdtheory.com/public\\_html/paddark/paddark.html#mass3](http://tgdtheory.com/public_html/paddark/paddark.html#mass3), 2006.
- [K47] M. Pitkänen. p-Adic Physics as Physics of Cognition and Intention. In *TGD Inspired Theory of Consciousness*. Onlinebook. [http://tgdtheory.com/public\\_html/tgdconsc/tgdconsc.html#cognic](http://tgdtheory.com/public_html/tgdconsc/tgdconsc.html#cognic), 2006.
- [K48] M. Pitkänen. *Physics in Many-Sheeted Space-Time*. Onlinebook. [http://tgdtheory.com/public\\_html/tgdclass/tgdclass.html](http://tgdtheory.com/public_html/tgdclass/tgdclass.html), 2006.
- [K49] M. Pitkänen. Quantum Antenna Hypothesis. In *Quantum Hardware of Living Matter*. Onlinebook. [http://tgdtheory.com/public\\_html/bioware/bioware.html#tubuc](http://tgdtheory.com/public_html/bioware/bioware.html#tubuc), 2006.
- [K50] M. Pitkänen. Quantum Astrophysics. In *Physics in Many-Sheeted Space-Time*. Onlinebook. [http://tgdtheory.com/public\\_html/tgdclass/tgdclass.html#qastro](http://tgdtheory.com/public_html/tgdclass/tgdclass.html#qastro), 2006.
- [K51] M. Pitkänen. Quantum Control and Coordination in Bio-systems: Part I. In *Bio-Systems as Self-Organizing Quantum Systems*. Onlinebook. [http://tgdtheory.com/public\\_html/bioselforg/bioselforg.html#qcococI](http://tgdtheory.com/public_html/bioselforg/bioselforg.html#qcococI), 2006.
- [K52] M. Pitkänen. Quantum Control and Coordination in Bio-Systems: Part II. In *Bio-Systems as Self-Organizing Quantum Systems*. Onlinebook. [http://tgdtheory.com/public\\_html/bioselforg/bioselforg.html#qcococII](http://tgdtheory.com/public_html/bioselforg/bioselforg.html#qcococII), 2006.

- [K53] M. Pitkänen. *Quantum Hardware of Living Matter*. Onlinebook. [http://tgdtheory.com/public\\_html/bioware/bioware.html](http://tgdtheory.com/public_html/bioware/bioware.html), 2006.
- [K54] M. Pitkänen. Quantum Model for Hearing. In *TGD and EEG*. Onlinebook. [http://tgdtheory.com/public\\_html//tgdeeg/tgdeeg/tgdeeg.html#hearing](http://tgdtheory.com/public_html//tgdeeg/tgdeeg/tgdeeg.html#hearing), 2006.
- [K55] M. Pitkänen. Quantum Model for Nerve Pulse. In *TGD and EEG*. Onlinebook. [http://tgdtheory.com/public\\_html//tgdeeg/tgdeeg/tgdeeg.html#pulse](http://tgdtheory.com/public_html//tgdeeg/tgdeeg/tgdeeg.html#pulse), 2006.
- [K56] M. Pitkänen. Quantum Model for Paranormal Phenomena. In *TGD Inspired Theory of Consciousness*. Onlinebook. [http://tgdtheory.com/public\\_html/tgdconsc/tgdconsc.html#parac](http://tgdtheory.com/public_html/tgdconsc/tgdconsc.html#parac), 2006.
- [K57] M. Pitkänen. Quantum Model for Sensory Representations. In *TGD Inspired Theory of Consciousness*. Onlinebook. [http://tgdtheory.com/public\\_html/tgdconsc/tgdconsc.html#expc](http://tgdtheory.com/public_html/tgdconsc/tgdconsc.html#expc), 2006.
- [K58] M. Pitkänen. Quantum Model of EEG. In *TGD and EEG*. Onlinebook. [http://tgdtheory.com/public\\_html/tgdeeg/tgdeeg.html#eegII](http://tgdtheory.com/public_html/tgdeeg/tgdeeg.html#eegII), 2006.
- [K59] M. Pitkänen. Quantum Model of Memory. In *TGD Inspired Theory of Consciousness*. Onlinebook. [http://tgdtheory.com/public\\_html/tgdconsc/tgdconsc.html#memoryc](http://tgdtheory.com/public_html/tgdconsc/tgdconsc.html#memoryc), 2006.
- [K60] M. Pitkänen. *Quantum Physics as Infinite-Dimensional Geometry*. Onlinebook. [http://tgdtheory.com/public\\_html/tgdgeom/tgdgeom.html](http://tgdtheory.com/public_html/tgdgeom/tgdgeom.html), 2006.
- [K61] M. Pitkänen. *Quantum TGD*. Onlinebook. [http://tgdtheory.com/public\\_html/tgdquant/tgdquant.html](http://tgdtheory.com/public_html/tgdquant/tgdquant.html), 2006.
- [K62] M. Pitkänen. Quantum Theory of Self-Organization. In *Bio-Systems as Self-Organizing Quantum Systems*. Onlinebook. [http://tgdtheory.com/public\\_html/bioselforg/bioselforg.html#selforgac](http://tgdtheory.com/public_html/bioselforg/bioselforg.html#selforgac), 2006.
- [K63] M. Pitkänen. Semi-trance, Mental Illness, and Altered States of Consciousness. In *Magnetospheric Consciousness*. Onlinebook. [http://tgdtheory.com/public\\_html/magnconsc/magnconsc.html#semitrancec](http://tgdtheory.com/public_html/magnconsc/magnconsc.html#semitrancec), 2006.
- [K64] M. Pitkänen. Semitrance, Language, and Development of Civilization. In *Magnetospheric Consciousness*. Onlinebook. [http://tgdtheory.com/public\\_html/magnconsc/magnconsc.html#langsoc](http://tgdtheory.com/public_html/magnconsc/magnconsc.html#langsoc), 2006.
- [K65] M. Pitkänen. TGD and Astrophysics. In *Physics in Many-Sheeted Space-Time*. Onlinebook. [http://tgdtheory.com/public\\_html/tgdclass/tgdclass.html#astro](http://tgdtheory.com/public_html/tgdclass/tgdclass.html#astro), 2006.
- [K66] M. Pitkänen. TGD and Cosmology. In *Physics in Many-Sheeted Space-Time*. Onlinebook. [http://tgdtheory.com/public\\_html/tgdclass/tgdclass.html#cosmo](http://tgdtheory.com/public_html/tgdclass/tgdclass.html#cosmo), 2006.
- [K67] M. Pitkänen. *TGD and EEG*. Onlinebook. [http://tgdtheory.com/public\\_html/tgdeeg/tgdeeg.html](http://tgdtheory.com/public_html/tgdeeg/tgdeeg.html), 2006.
- [K68] M. Pitkänen. *TGD and Fringe Physics*. Onlinebook. [http://tgdtheory.com/public\\_html/freenergy/freenergy.html](http://tgdtheory.com/public_html/freenergy/freenergy.html), 2006.
- [K69] M. Pitkänen. TGD and Nuclear Physics. In *p-Adic Length Scale Hypothesis and Dark Matter Hierarchy*. Onlinebook. [http://tgdtheory.com/public\\_html/paddark/paddark.html#padnucl](http://tgdtheory.com/public_html/paddark/paddark.html#padnucl), 2006.
- [K70] M. Pitkänen. *TGD as a Generalized Number Theory*. Onlinebook. [http://tgdtheory.com/public\\_html/tgdnumber/tgdnumber.html](http://tgdtheory.com/public_html/tgdnumber/tgdnumber.html), 2006.
- [K71] M. Pitkänen. TGD as a Generalized Number Theory: p-Adicization Program. In *TGD as a Generalized Number Theory*. Onlinebook. [http://tgdtheory.com/public\\_html/tgdnumber/tgdnumber.html#visiona](http://tgdtheory.com/public_html/tgdnumber/tgdnumber.html#visiona), 2006.



- [K72] M. Pitkänen. TGD as a Generalized Number Theory: Quaternions, Octonions, and their Hyper Counterparts. In *TGD as a Generalized Number Theory*. Onlinebook. [http://tgdtheory.com/public\\_html/tgdnumber/tgdnumber.html#visionb](http://tgdtheory.com/public_html/tgdnumber/tgdnumber.html#visionb), 2006.
- [K73] M. Pitkänen. TGD Based Model for OBEs. In *TGD Inspired Theory of Consciousness*. Onlinebook. [http://tgdtheory.com/public\\_html/tgdconsc/tgdconsc.html#OBE](http://tgdtheory.com/public_html/tgdconsc/tgdconsc.html#OBE), 2006.
- [K74] M. Pitkänen. *TGD Inspired Theory of Consciousness*. Onlinebook. [http://tgdtheory.com/public\\_html/tgdconsc/tgdconsc.html](http://tgdtheory.com/public_html/tgdconsc/tgdconsc.html), 2006.
- [K75] M. Pitkänen. TGD Inspired Theory of Consciousness. In *Topological Geometrodynamics: Overview*. Onlinebook. [http://tgdtheory.com/public\\_html/tgdview/tgdview.html#tgdconsc2010](http://tgdtheory.com/public_html/tgdview/tgdview.html#tgdconsc2010), 2006.
- [K76] M. Pitkänen. The Notion of Free Energy and Many-Sheeted Space-Time Concept. In *TGD and Fringe Physics*. Onlinebook. [http://tgdtheory.com/public\\_html/freenergy/freenergy.html#freenergy](http://tgdtheory.com/public_html/freenergy/freenergy.html#freenergy), 2006.
- [K77] M. Pitkänen. The Relationship Between TGD and GRT. In *Physics in Many-Sheeted Space-Time*. Onlinebook. [http://tgdtheory.com/public\\_html/tgdclass/tgdclass.html#tgdgrt](http://tgdtheory.com/public_html/tgdclass/tgdclass.html#tgdgrt), 2006.
- [K78] M. Pitkänen. Three new physics realizations of the genetic code and the role of dark matter in bio-systems. In *Genes and Memes*. Onlinebook. [http://tgdtheory.com/public\\_html/genememe/genememe.html#dnatqccodes](http://tgdtheory.com/public_html/genememe/genememe.html#dnatqccodes), 2006.
- [K79] M. Pitkänen. Time, Spacetime and Consciousness. In *Bio-Systems as Conscious Holograms*. Onlinebook. [http://tgdtheory.com/public\\_html/hologram/hologram.html#time](http://tgdtheory.com/public_html/hologram/hologram.html#time), 2006.
- [K80] M. Pitkänen. *Topological Geometrodynamics: an Overview*. Onlinebook. [http://tgdtheory.com/public\\_html/tgdview/tgdview.html](http://tgdtheory.com/public_html/tgdview/tgdview.html), 2006.
- [K81] M. Pitkänen. Topological Quantum Computation in TGD Universe. In *Genes and Memes*. Onlinebook. [http://tgdtheory.com/public\\_html/genememe/genememe.html#tqc](http://tgdtheory.com/public_html/genememe/genememe.html#tqc), 2006.
- [K82] M. Pitkänen. Was von Neumann Right After All. In *Towards M-Matrix*. Onlinebook. [http://tgdtheory.com/public\\_html/tgdquant/tgdquant.html#vNeumann](http://tgdtheory.com/public_html/tgdquant/tgdquant.html#vNeumann), 2006.
- [K83] M. Pitkänen. Wormhole Magnetic Fields. In *Quantum Hardware of Living Matter*. Onlinebook. [http://tgdtheory.com/public\\_html/bioware/bioware.html#wormc](http://tgdtheory.com/public_html/bioware/bioware.html#wormc), 2006.



# Articles about TGD

- [L1] M. Pitkänen. Macro-temporal quantum coherence, quantum spin glass degeneracy, and number theoretic information concept. <http://www.emergentmind.org/journal.htm>, 2003.
- [L2] M. Pitkänen. Time, Space-Time, and Consciousness. <http://www.emergentmind.org/journal.htm>, 2003.
- [L3] M. Pitkänen. Further Progress in Nuclear String Hypothesis. <http://tgdtheory.com/articles/nuclstring.pdf>, 2007.
- [L4] M. Pitkänen. TGD based solution of Fermi paradox. <http://www.physics.helsinki.fi/~matpitka/articles/fermieng.pdf>, 2007.



## Chapter 3

# The Recent Vision about Preferred Extremals and Solutions of the Modified Dirac Equation

### 3.1 Introduction

During years several approaches to what preferred extremals of Kähler action and solutions of the modified Dirac equation could be have been proposed and the challenge is to see whether at least some of these approaches are consistent with each other. It is good to list various approaches first.

1. For preferred extremals generalization of conformal invariance to 4-D situation is very attractive approach and leads to concrete conditions formally similar to those encountered in string model [K9]. In particular, Einstein's equations with cosmological constant follow as consistency conditions and field equations reduce to a purely algebraic statements analogous to those appearing in equations for minimal surfaces if one assumes that space-time surface has Hermitian structure or its Minkowskian variant Hamilton-Jacobi structure (Appendix). The older approach based on basic heuristics for massless equations, on effective 3-dimensionality, and weak form of electric magnetic duality, and Beltrami flows is also promising. An alternative approach is inspired by number theoretical considerations and identifies space-time surfaces as associative or co-associative sub-manifolds of octonionic imbedding space [K72].

The basic step of progress was the realization that the known extremals of Kähler action - certainly limiting cases of more general extremals - can be deformed to more general extremals having interpretation as preferred extremals.

- (a) The generalization boils down to the condition that field equations reduce to the condition that the traces  $Tr(TH^k)$  for the product of energy momentum tensor and second fundamental form vanish. In string models energy momentum tensor corresponds to metric and one obtains minimal surface equations. The equations reduce to purely algebraic conditions stating that  $T$  and  $H^k$  have no common components. Complex structure of string world sheet makes this possible.

Stringy conditions for metric stating  $g_{zz} = g_{\bar{z}\bar{z}} = 0$  generalize. The condition that field equations reduce to  $Tr(TH^k) = 0$  requires that the terms involving Kähler gauge current in field equations vanish. This is achieved if Einstein's equations hold true. The conditions guaranteeing the vanishing of the trace in turn boil down to the existence of Hermitian structure in the case of Euclidian signature and to the existence of its analog - Hamilton-Jacobi structure - for Minkowskian signature (Appendix). These conditions state that certain components of the induced metric vanish in complex coordinates or Hamilton-Jacobi coordinates.

In string model the replacement of the imbedding space coordinate variables with quantized ones allows to interpret the conditions on metric as Virasoro conditions. In the recent case generalization of classical Virasoro conditions to four-dimensional ones would be in question.

An interesting question is whether quantization of these conditions could make sense also in TGD framework at least as a useful trick to deduce information about quantum states in WCW degrees of freedom.

The interpretation of the extended algebra as Yangian [?] [?] suggested previously [?] to act as a generalization of conformal algebra in TGD Universe is attractive. There is also the conjecture that preferred extremals could be interpreted as quaternionic or co-quaternionic 4-surface of the octonionic imbedding space with octonionic representation of the gamma matrices defining the notion of tangent space quaternionicity.

2. There are also several approaches for solving the modified Dirac equation. The most promising approach is assumes that the solutions are restricted on 2-D stringy world sheets and/or partonic 2-surfaces. This strange looking view is a rather natural consequence of both strong form of holography and of number theoretic vision, and also follows from the notion of finite measurement resolution having discretization at partonic 2-surfaces as a geometric correlate. The conditions stating that electric charge is conserved for preferred extremals is an alternative very promising approach. One expects that stringy approach based on 4-D generalization of conformal invariance or its 2-D variant at 2-D preferred surfaces should also allow to understand the modified Dirac equation. In accordance with the earlier conjecture, all modes of the modified Dirac operator generate badly broken super-symmetries. Right-handed neutrino allows also holomorphic modes delocalized at entire space-time surface and the delocalization inside Euclidian region defining the line of generalized Feynman diagram is a good candidate for the right-handed neutrino generating the least broken super-symmetry. This super-symmetry seems however to differ from the ordinary one in that  $\nu_R$  is expected to behave like a passive spectator in the scattering.

In the following the question whether these various approaches are mutually consistent is discussed. It indeed turns out that the approach based on the conservation of electric charge leads under rather general assumptions to the proposal that solutions of the modified Dirac equation are localized on 2-dimensional string world sheets and/or partonic 2-surfaces. Einstein's equations are satisfied for the preferred extremals and this implies that the earlier proposal for the realization of Equivalence Principle is not needed. This leads to a considerable progress in the understanding of super Virasoro representations for super-symplectic and super-Kac-Moody algebra. In particular, the proposal is that super-Kac-Moody currents assignable to string world sheets define duals of gauge potentials and their generalization for gravitons: in the approximation that gauge group is Abelian - motivated by the notion of finite measurement resolution - the exponents for the sum of KM charges would define non-integrable phase factors. One can also identify Yangian as the algebra generated by these charges. The approach allows also to understand the special role of the right handed neutrino in SUSY according to TGD.

## 3.2 About deformations of known extremals of Kähler action

I have done a considerable amount of speculative guesswork to identify what I have used to call preferred extremals of Kähler action. The problem is that the mathematical problem at hand is extremely non-linear and that there is no existing mathematical literature. One must proceed by trying to guess the general constraints on the preferred extremals which look physically and mathematically plausible. The hope is that this net of constraints could eventually crystallize to Eureka! Certainly the recent speculative picture involves also wrong guesses. The need to find explicit ansatz for the deformations of known extremals based on some common principles has become pressing. The following considerations represent an attempt to combine the existing information to achieve this.

### 3.2.1 What might be the common features of the deformations of known extremals

The dream is to discover the deformations of all known extremals by guessing what is common to all of them. One might hope that the following list summarizes at least some common features.

### Effective three-dimensionality at the level of action

1. Holography realized as effective 3-dimensionality also at the level of action requires that it reduces to 3-dimensional effective boundary terms. This is achieved if the contraction  $j^\alpha A_\alpha$  vanishes. This is true if  $j^\alpha$  vanishes or is light-like, or if it is proportional to instanton current in which case current conservation requires that  $CP_2$  projection of the space-time surface is 3-dimensional. The first two options for  $j$  have a realization for known extremals. The status of the third option - proportionality to instanton current - has remained unclear.
2. As I started to work again with the problem, I realized that instanton current could be replaced with a more general current  $j = *B \wedge J$  or concretely:  $j^\alpha = \epsilon^{\alpha\beta\gamma\delta} B_\beta J_{\gamma\delta}$ , where  $B$  is vector field and  $CP_2$  projection is 3-dimensional, which it must be in any case. The contractions of  $j$  appearing in field equations vanish automatically with this ansatz.
3. Almost topological QFT property in turn requires the reduction of effective boundary terms to Chern-Simons terms: this is achieved by boundary conditions expressing weak form of electric magnetic duality. If one generalizes the weak form of electric magnetic duality to  $J = \Phi * J$  one has  $B = d\Phi$  and  $j$  has a vanishing divergence for 3-D  $CP_2$  projection. This is clearly a more general solution ansatz than the one based on proportionality of  $j$  with instanton current and would reduce the field equations in concise notation to  $Tr(TH^k) = 0$ .
4. Any of the alternative properties of the Kähler current implies that the field equations reduce to  $Tr(TH^k) = 0$ , where  $T$  and  $H^k$  are shorthands for Maxwellian energy momentum tensor and second fundamental form and the product of tensors is obvious generalization of matrix product involving index contraction.

### Could Einstein's equations emerge dynamically?

For  $j^\alpha$  satisfying one of the three conditions, the field equations have the same form as the equations for minimal surfaces except that the metric  $g$  is replaced with Maxwell energy momentum tensor  $T$ .

1. This raises the question about dynamical generation of small cosmological constant  $\Lambda$ :  $T = \Lambda g$  would reduce equations to those for minimal surfaces. For  $T = \Lambda g$  modified gamma matrices would reduce to induced gamma matrices and the modified Dirac operator would be proportional to ordinary Dirac operator defined by the induced gamma matrices. One can also consider weak form for  $T = \Lambda g$  obtained by restricting the consideration to sub-space of tangent space so that space-time surface is only "partially" minimal surface but this option is not so elegant although necessary for other than  $CP_2$  type vacuum extremals.
2. What is remarkable is that  $T = \Lambda g$  implies that the divergence of  $T$  which in the general case equals to  $j^\beta J_\beta^\alpha$  vanishes. This is guaranteed by one of the conditions for the Kähler current. Since also Einstein tensor has a vanishing divergence, one can ask whether the condition to  $T = \kappa G + \Lambda g$  could be the general condition. This would give Einstein's equations with cosmological term besides the generalization of the minimal surface equations. GRT would emerge dynamically from the non-linear Maxwell's theory although in slightly different sense as conjectured [K77]! Note that the expression for  $G$  involves also second derivatives of the imbedding space coordinates so that actually a partial differential equation is in question. If field equations reduce to purely algebraic ones, as the basic conjecture states, it is possible to have  $Tr(GH^k) = 0$  and  $Tr(gH^k) = 0$  separately so that also minimal surface equations would hold true.

What is amusing that the first guess for the action of TGD was curvature scalar. It gave analogs of Einstein's equations as a definition of conserved four-momentum currents. The recent proposal would give the analog of ordinary Einstein equations as a dynamical constraint relating Maxwellian energy momentum tensor to Einstein tensor and metric.

3. Minimal surface property is physically extremely nice since field equations can be interpreted as a non-linear generalization of massless wave equation: something very natural for non-linear variant of Maxwell action. The theory would be also very "stringy" although the fundamental action would not be space-time volume. This can however hold true only for Euclidian signature. Note that for  $CP_2$  type vacuum extremals Einstein tensor is proportional to metric so that for

them the two options are equivalent. For their small deformations situation changes and it might happen that the presence of  $G$  is necessary. The GRT limit of TGD discussed in [K77] [?] indeed suggests that  $CP_2$  type solutions satisfy Einstein's equations with large cosmological constant and that the small observed value of the cosmological constant is due to averaging and small volume fraction of regions of Euclidian signature (lines of generalized Feynman diagrams).

4. For massless extremals and their deformations  $T = \Lambda g$  cannot hold true. The reason is that for massless extremals energy momentum tensor has component  $T^{vv}$  which actually quite essential for field equations since one has  $H_{vv}^k = 0$ . Hence for massless extremals and their deformations  $T = \Lambda g$  cannot hold true if the induced metric has Hamilton-Jacobi structure meaning that  $g^{uu}$  and  $g^{vv}$  vanish. A more general relationship of form  $T = \kappa G + \Lambda G$  can however be consistent with non-vanishing  $T^{vv}$  but require that deformation has at most 3-D  $CP_2$  projection ( $CP_2$  coordinates do not depend on  $v$ ).
5. The non-determinism of vacuum extremals suggest for their non-vacuum deformations a conflict with the conservation laws. In, also massless extremals are characterized by a non-determinism with respect to the light-like coordinate but like-likeness saves the situation. This suggests that the transformation of a properly chosen time coordinate of vacuum extremal to a light-like coordinate in the induced metric combined with Einstein's equations in the induced metric of the deformation could allow to handle the non-determinism.

**Are complex structure of  $CP_2$  and Hamilton-Jacobi structure of  $M^4$  respected by the deformations?**

The complex structure of  $CP_2$  and Hamilton-Jacobi structure of  $M^4$  could be central for the understanding of the preferred extremal property algebraically.

1. There are reasons to believe that the Hermitian structure of the induced metric ((1,1) structure in complex coordinates) for the deformations of  $CP_2$  type vacuum extremals could be crucial property of the preferred extremals. Also the presence of light-like direction is also an essential elements and 3-dimensionality of  $M^4$  projection could be essential. Hence a good guess is that allowed deformations of  $CP_2$  type vacuum extremals are such that (2,0) and (0,2) components the induced metric and/or of the energy momentum tensor vanish. This gives rise to the conditions implying Virasoro conditions in string models in quantization:

$$g_{\xi^i \xi^j} = 0 \quad , \quad g_{\bar{\xi}^i \bar{\xi}^j} = 0 \quad , \quad i, j = 1, 2 \quad . \tag{3.2.1}$$

Holomorphisms of  $CP_2$  preserve the complex structure and Virasoro conditions are expected to generalize to 4-dimensional conditions involving two complex coordinates. This means that the generators have two integer valued indices but otherwise obey an algebra very similar to the Virasoro algebra. Also the super-conformal variant of this algebra is expected to make sense.

These Virasoro conditions apply in the coordinate space for  $CP_2$  type vacuum extremals. One expects similar conditions hold true also in field space, that is for  $M^4$  coordinates.

2. The integrable decomposition  $M^4(m) = M^2(m) + E^2(m)$  of  $M^4$  tangent space to longitudinal and transversal parts (non-physical and physical polarizations) - Hamilton-Jacobi structure- could be a very general property of preferred extremals and very natural since non-linear Maxwellian electrodynamics is in question. This decomposition led rather early to the introduction of the analog of complex structure in terms of what I called Hamilton-Jacobi coordinates  $(u, v, w, \bar{w})$  for  $M^4$ .  $(u, v)$  defines a pair of light-like coordinates for the local longitudinal space  $M^2(m)$  and  $(w, \bar{w})$  complex coordinates for  $E^2(m)$ . The Hamilton-Jacobi conditions on induced metric would be obtained by replacing imaginary unit in the definition of Hermitian metric for some complex coordinates with  $e$ ,  $e^2 = 1$  and defining hyper-complex conjugation as  $u \rightarrow v$  for light-like-coordinate (Appendix).

A good guess is that the deformations of massless extremals respect this structure. This condition gives rise to the analog of the constraints leading to Virasoro conditions stating the vanishing



of the non-allowed components of the induced metric plus the analogs of hermiticity conditions. Again the generators of the algebra would involve two integers and the structure is that of Virasoro algebra and also generalization to super algebra is expected to make sense. The moduli space of Hamilton-Jacobi structures would be part of the moduli space of the preferred extremals and analogous to the space of all possible choices of complex coordinates. The analogs of infinitesimal holomorphic transformations would preserve the modular parameters and give rise to a 4-dimensional Minkowskian analog of Virasoro algebra. The conformal algebra acting on  $CP_2$  coordinates acts in field degrees of freedom for Minkowskian signature.

### Field equations as purely algebraic conditions

If the proposed picture is correct, field equations would reduce basically to purely algebraically conditions stating that the Maxwellian energy momentum tensor has no common index pairs with the second fundamental form. For the deformations of  $CP_2$  type vacuum extremals  $T$  is a complex tensor of type (1,1) and second fundamental form  $H^k$  a tensor of type (2,0) and (0,2) so that  $Tr(TH^k) = 0$  is true. This requires that second light-like coordinate of  $M^4$  is constant so that the  $M^4$  projection is 3-dimensional. For Minkowskian signature of the induced metric Hamilton-Jacobi structure replaces conformal structure. Here the dependence of  $CP_2$  coordinates on second light-like coordinate of  $M^2(m)$  only plays a fundamental role. Note that now  $T^{vv}$  is non-vanishing (and light-like). This picture generalizes to the deformations of cosmic strings and even to the case of vacuum extremals.

### 3.2.2 What small deformations of $CP_2$ type vacuum extremals could be?

I was led to these arguments when I tried find preferred extremals of Kähler action, which would have 4-D  $CP_2$  and  $M^4$  projections - the Maxwell phase analogous to the solutions of Maxwell's equations that I conjectured long time ago. It however turned out that the dimensions of the projections can be ( $D_{M^4} \leq 3, D_{CP_2} = 4$ ) or ( $D_{M^4} = 4, D_{CP_2} \leq 3$ ). What happens is essentially breakdown of linear superposition so that locally one can have superposition of modes which have 4-D wave vectors in the same direction. This is actually very much like quantization of radiation field to photons now represented as separate space-time sheets and one can say that Maxwellian superposition corresponds to union of separate photonic space-time sheets in TGD. In the following I shall restrict the consideration to the deformations of  $CP_2$  type vacuum extremals.

#### Solution ansatz

I proceed by the following arguments to the ansatz.

1. Effective 3-dimensionality for action (holography) requires that action decomposes to vanishing  $j^\alpha A_\alpha$  term + total divergence giving 3-D "boundary" terms. The first term certainly vanishes (giving effective 3-dimensionality) for

$$D_\beta J^{\alpha\beta} = j^\alpha = 0 .$$

Empty space Maxwell equations, something extremely natural. Also for the proposed GRT limit these equations are true.

2. How to obtain empty space Maxwell equations  $j^\alpha = 0$ ? The answer is simple: assume self duality or its slight modification:

$$J = *J$$

holding for  $CP_2$  type vacuum extremals or a more general condition

$$J = k * J ,$$

In the simplest situation  $k$  is some constant not far from unity.  $*$  is Hodge dual involving 4-D permutation symbol.  $k = \text{constant}$  requires that the determinant of the induced metric is apart from constant equal to that of  $CP_2$  metric. It does not require that the induced metric

is proportional to the  $CP_2$  metric, which is not possible since  $M^4$  contribution to metric has Minkowskian signature and cannot be therefore proportional to  $CP_2$  metric.

One can consider also a more general situation in which  $k$  is scalar function as a generalization of the weak electric-magnetic duality. In this case the Kähler current is non-vanishing but divergenceless. This also guarantees the reduction to  $Tr(TH^k) = 0$ . In this case however the proportionality of the metric determinant to that for  $CP_2$  metric is not needed. This solution ansatz becomes therefore more general.

3. Field equations reduce with these assumptions to equations differing from minimal surfaces equations only in that metric  $g$  is replaced by Maxwellian energy momentum tensor  $T$ . Schematically:

$$Tr(TH^k) = 0 \quad ,$$

where  $T$  is the Maxwellian energy momentum tensor and  $H^k$  is the second fundamental form - asymmetric 2-tensor defined by covariant derivative of gradients of imbedding space coordinates.

**How to satisfy the condition  $Tr(TH^k) = 0$ ?**

It would be nice to have minimal surface equations since they are the non-linear generalization of massless wave equations. It would be also nice to have the vanishing of the terms involving Kähler current in field equations as a consequence of this condition. Indeed,  $T = \kappa G + \Lambda g$  implies this. In the case of  $CP_2$  vacuum extremals one cannot distinguish between these options since  $CP_2$  itself is constant curvature space with  $G \propto g$ . Furthermore, if  $G$  and  $g$  have similar tensor structure the algebraic field equations for  $G$  and  $g$  are satisfied separately so that one obtains minimal surface property also now. In the following minimal surface option is considered.

1. The first option is achieved if one has

$$T = \Lambda g \quad .$$

Maxwell energy momentum tensor would be proportional to the metric! One would have dynamically generated cosmological constant! This begins to look really interesting since it appeared also at the proposed GRT limit of TGD [?]. Note that here also non-constant value of  $\Lambda$  can be considered and would correspond to a situation in which  $k$  is scalar function: in this case the the determinant condition can be dropped and one obtains just the minimal surface equations.

2. Very schematically and forgetting indices and being sloppy with signs, the expression for  $T$  reads as

$$T = JJ - g/4Tr(JJ) \quad .$$

Note that the product of tensors is obtained by generalizing matrix product. This should be proportional to metric.

Self duality implies that  $Tr(JJ)$  is just the instanton density and does not depend on metric and is constant.

For  $CP_2$  type vacuum extremals one obtains

$$T = -g + g = 0 \quad .$$

Cosmological constant would vanish in this case.

3. Could it happen that for deformations a small value of cosmological constant is generated?

The condition would reduce to

$$JJ = (\Lambda - 1)g \quad .$$

$\Lambda$  must relate to the value of parameter  $k$  appearing in the generalized self-duality condition. For the most general ansatz  $\Lambda$  would not be constant anymore.

This would generalize the defining condition for Kähler form

$$JJ = -g \quad (i^2 = -1 \text{ geometrically})$$

stating that the square of Kähler form is the negative of metric. The only modification would be that index raising is carried out by using the induced metric containing also  $M^4$  contribution rather than  $CP_2$  metric.

4. Explicitly:

$$J_{\alpha\mu}J^{\mu}_{\beta} = (\Lambda - 1)g_{\alpha\beta} \ .$$

Cosmological constant would measure the breaking of Kähler structure. By writing  $g = s+m$  and defining index raising of tensors using  $CP_2$  metric and their product accordingly, this condition can be also written as

$$Jm = (\Lambda - 1)mJ \ .$$

If the parameter  $k$  is constant, the determinant of the induced metric must be proportional to the  $CP_2$  metric. If  $k$  is scalar function, this condition can be dropped. Cosmological constant would not be constant anymore but the dependence on  $k$  would drop out from the field equations and one would hope of obtaining minimal surface equations also now. It however seems that the dimension of  $M^4$  projection cannot be four. For 4-D  $M^4$  projection the contribution of the  $M^2$  part of the  $M^4$  metric gives a non-holomorphic contribution to  $CP_2$  metric and this spoils the field equations.

For  $T = \kappa G + \Lambda g$  option the value of the cosmological constant is large - just as it is for the proposed GRT limit of TGD [K77] [?]. The interpretation in this case is that the average value of cosmological constant is small since the portion of space-time volume containing generalized Feynman diagrams is very small.

### More detailed ansatz for the deformations of $CP_2$ type vacuum extremals

One can develop the ansatz to a more detailed form. The most obvious guess is that the induced metric is apart from constant conformal factor the metric of  $CP_2$ . This would guarantee self-duality apart from constant factor and  $j^\alpha = 0$ . Metric would be in complex  $CP_2$  coordinates tensor of type (1,1) whereas  $CP_2$  Riemann connection would have only purely holomorphic or anti-holomorphic indices. Therefore  $CP_2$  contributions in  $Tr(TH^k)$  would vanish identically.  $M^4$  degrees of freedom however bring in difficulty. The  $M^4$  contribution to the induced metric should be proportional to  $CP_2$  metric and this is impossible due to the different signatures. The  $M^4$  contribution to the induced metric breaks its Kähler property but would preserve Hermitian structure.

A more realistic guess based on the attempt to construct deformations of  $CP_2$  type vacuum extremals is following.

1. Physical intuition suggests that  $M^4$  coordinates can be chosen so that one has integrable decomposition to longitudinal degrees of freedom parametrized by two light-like coordinates  $u$  and  $v$  and to transversal polarization degrees of freedom parametrized by complex coordinate  $w$  and its conjugate.  $M^4$  metric would reduce in these coordinates to a direct sum of longitudinal and transverse parts. I have called these coordinates Hamilton Jacobi coordinates.
2.  $w$  would be holomorphic function of  $CP_2$  coordinates and therefore satisfy massless wave equation. This would give hopes about rather general solution ansatz.  $u$  and  $v$  cannot be holomorphic functions of  $CP_2$  coordinates. Unless wither  $u$  or  $v$  is constant, the induced metric would receive contributions of type (2,0) and (0,2) coming from  $u$  and  $v$  which would break Kähler structure and complex structure. These contributions would give no-vanishing contribution to all minimal surface equations. Therefore either  $u$  or  $v$  is constant: the coordinate line for non-constant coordinate -say  $u$ - would be analogous to the  $M^4$  projection of  $CP_2$  type vacuum extremal.

3. With these assumptions the induced metric would remain (1,1) tensor and one might hope that  $Tr(TH^k)$  contractions vanishes for all variables except  $u$  because there are no common index pairs (this if non-vanishing Christoffel symbols for  $H$  involve only holomorphic or anti-holomorphic indices in  $CP_2$  coordinates). For  $u$  one would obtain massless wave equation expressing the minimal surface property.
4. If the value of  $k$  is constant the determinant of the induced metric must be proportional to the determinant of  $CP_2$  metric. The induced metric would contain only the contribution from the transversal degrees of freedom besides  $CP_2$  contribution. Minkowski contribution has however rank 2 as  $CP_2$  tensor and cannot be proportional to  $CP_2$  metric. It is however enough that its determinant is proportional to the determinant of  $CP_2$  metric with constant proportionality coefficient. This condition gives an additional non-linear condition to the solution. One would have wave equation for  $u$  (also  $w$  and its conjugate satisfy massless wave equation) and determinant condition as an additional condition.

The determinant condition reduces by the linearity of determinant with respect to its rows to sum of conditions involved 0,1,2 rows replaced by the transversal  $M^4$  contribution to metric given if  $M^4$  metric decomposes to direct sum of longitudinal and transversal parts. Derivatives with respect to derivative with respect to particular  $CP_2$  complex coordinate appear linearly in this expression they can depend on  $u$  via the dependence of transversal metric components on  $u$ . The challenge is to show that this equation has (or does not have) non-trivial solutions.

5. If the value of  $k$  is scalar function the situation changes and one has only the minimal surface equations and Virasoro conditions.

What makes the ansatz attractive is that special solutions of Maxwell empty space equations are in question, equations reduces to non-linear generalizations of Euclidian massless wave equations, and possibly space-time dependent cosmological constant pops up dynamically. These properties are true also for the GRT limit of TGD [?].

### 3.2.3 Hamilton-Jacobi conditions in Minkowskian signature

The maximally optimistic guess is that the basic properties of the deformations of  $CP_2$  type vacuum extremals generalize to the deformations of other known extremals such as massless extremals, vacuum extremals with 2-D  $CP_2$  projection which is Lagrangian manifold, and cosmic strings characterized by Minkowskian signature of the induced metric. These properties would be following.

1. The recomposition of  $M^4$  tangent space to longitudinal and transversal parts giving Hamilton-Jacobi structure. The longitudinal part has hypercomplex structure but the second light-like coordinate is constant: this plays a crucial role in guaranteeing the vanishing of contractions in  $Tr(TH^k)$ . It is the algebraic properties of  $g$  and  $T$  which are crucial.  $T$  can however have light-like component  $T^{vv}$ . For the deformations of  $CP_2$  type vacuum extremals (1,1) structure is enough and is guaranteed if second light-like coordinate of  $M^4$  is constant whereas  $w$  is holomorphic function of  $CP_2$  coordinates.
2. What could happen in the case of massless extremals? Now one has 2-D  $CP_2$  projection in the initial situation and  $CP_2$  coordinates depend on light-like coordinate  $u$  and single real transversal coordinate. The generalization would be obvious: dependence on single light-like coordinate  $u$  and holomorphic dependence on  $w$  for complex  $CP_2$  coordinates. The constraint is  $T = \Lambda g$  cannot hold true since  $T^{vv}$  is non-vanishing (and light-like). This property restricted to transversal degrees of freedom could reduce the field equations to minimal surface equations in transversal degrees of freedom. The transversal part of energy momentum tensor would be proportional to metric and hence covariantly constant. Gauge current would remain light-like but would not be given by  $j = *d\phi \wedge J$ .  $T = \kappa G + \Lambda g$  seems to define the attractive option.

It therefore seems that the essential ingredient could be the condition

$$T = \kappa G + \lambda g \ ,$$

which has structure (1,1) in both  $M^2(m)$  and  $E^2(m)$  degrees of freedom apart from the presence of  $T^{vv}$  component with deformations having no dependence on  $v$ . If the second fundamental form has (2,0)+(0,2) structure, the minimal surface equations are satisfied provided Kähler current satisfies on of the proposed three conditions and if  $G$  and  $g$  have similar tensor structure.

One can actually pose the conditions of metric as complete analogs of stringy constraints leading to Virasoro conditions in quantization to give

$$g_{uu} = 0 \quad , \quad g_{vv} = 0 \quad , \quad g_{ww} = 0 \quad , \quad g_{\bar{w}\bar{w}} = 0 \quad . \quad (3.2.2)$$

This brings in mind the generalization of Virasoro algebra to four-dimensional algebra for which an identification in terms of non-local Yangian symmetry has been proposed [?]. The number of conditions is four and the same as the number of independent field equations. One can consider similar conditions also for the energy momentum tensor  $T$  but allowing non-vanishing component  $T^{vv}$  if deformations has no  $v$ -dependence. This would solve the field equations if the gauge current vanishes or is light-like. On this case the number of equations is 8. First order differential equations are in question and they can be also interpreted as conditions fixing the coordinates used since there is infinite number of manners to choose the Hamilton-Jacobi coordinates.

One can try to apply the physical intuition about general solutions of field equations in the linear case by writing the solution as a superposition of left and right propagating solutions:

$$\xi^k = f_+^k(u, w) + f_-^k(v, w) \quad . \quad (3.2.3)$$

This could guarantee that second fundamental form is of form (2,0)+(0,2) in both  $M^2$  and  $E^2$  part of the tangent space and these terms if  $Tr(TH^k)$  vanish identically. The remaining terms involve contractions of  $T^{uw}$ ,  $T^{u\bar{w}}$  and  $T^{vw}$ ,  $T^{v\bar{w}}$  with second fundamental form. Also these terms should sum up to zero or vanish separately. Second fundamental form has components coming from  $f_+^k$  and  $f_-^k$

Second fundamental form  $H^k$  has as basic building bricks terms  $\hat{H}^k$  given by

$$\hat{H}_{\alpha\beta}^k = \partial_\alpha \partial_\beta h^k + \binom{k}{l \ m} \partial_\alpha h^l \partial_\beta h^m \quad . \quad (3.2.4)$$

For the proposed ansatz the first terms give vanishing contribution to  $H_{uv}^k$ . The terms containing Christoffel symbols however give a non-vanishing contribution and one can allow only  $f_+^k$  or  $f_-^k$  as in the case of massless extremals. This reduces the dimension of  $CP_2$  projection to  $D = 3$ .

What about the condition for Kähler current? Kähler form has components of type  $J_{w\bar{w}}$  whose contravariant counterpart gives rise to space-like current component.  $J_{uw}$  and  $J_{u\bar{w}}$  give rise to light-like currents components. The condition would state that the  $J^{w\bar{w}}$  is covariantly constant. Solutions would be characterized by a constant Kähler magnetic field. Also electric field is represent. The interpretation both radiation and magnetic flux tube makes sense.

### 3.2.4 Deformations of cosmic strings

In the physical applications it has been assumed that the thickening of cosmic strings to Kähler magnetic flux tubes takes place. One indeed expects that the proposed construction generalizes also to the case of cosmic strings having the decomposition  $X^4 = X^2 \times Y^2 \subset M^4 \times CP_2$ , where  $X^2$  is minimal surface and  $Y^2$  a complex homologically non-trivial sub-manifold of  $CP_2$ . Now the starting point structure is Hamilton-Jacobi structure for  $M_m^2 \times Y^2$  defining the coordinate space.

1. The deformation should increase the dimension of either  $CP_2$  or  $M^4$  projection or both. How this thickening could take place? What comes in mind that the string orbits  $X^2$  can be interpreted as a distribution of longitudinal spaces  $M^2(x)$  so that for the deformation  $w$  coordinate becomes a holomorphic function of the natural  $Y^2$  complex coordinate so that  $M^4$  projection becomes 4-D but  $CP_2$  projection remains 2-D. The new contribution to the  $X^2$  part of the induced metric is vanishing and the contribution to the  $Y^2$  part is of type (1, 1) and the the ansatz  $T = \kappa G + \Lambda g$  might be needed as a generalization of the minimal surface equations The ratio of  $\kappa$  and  $G$  would be determined from the form of the Maxwellian energy momentum tensor and be fixed at the

limit of undeformed cosmic strong to  $T = (ag(Y^2) - bg(Y^2))$ . The value of cosmological constant is now large, and overall consistency suggests that  $T = \kappa G + \Lambda g$  is the correct option also for the  $CP_2$  type vacuum extremals.

2. One could also imagine that remaining  $CP_2$  coordinates could depend on the complex coordinate of  $Y^2$  so that also  $CP_2$  projection would become 4-dimensional. The induced metric would receive holomorphic contributions in  $Y^2$  part. As a matter fact, this option is already implied by the assumption that  $Y^2$  is a complex surface of  $CP_2$ .

### 3.2.5 Deformations of vacuum extremals?

What about the deformations of vacuum extremals representable as maps from  $M^4$  to  $CP_2$ ?

1. The basic challenge is the non-determinism of the vacuum extremals. One should perform the deformation so that conservation laws are satisfied. For massless extremals there is also non-determinism but it is associated with the light-like coordinate so that there are no problems with the conservation laws. This would suggest that a properly chosen time coordinate consistent with Hamilton-Jacobi decomposition becomes light-like coordinate in the induced metric. This poses a conditions on the induced metric.
2. Physical intuition suggests that one cannot require  $T = \Lambda g$  since this would mean that the rank of  $T$  is maximal whereas the original situation corresponds to the vanishing of  $T$ . For small deformations rank two for  $T$  looks more natural and one could think that  $T$  is proportional to a projection of metric to a 2-D subspace. The vision about the long length scale limit of TGD is that Einstein's equations are satisfied and this would suggest  $T = kG$  or  $T = \kappa G + \Lambda g$ . The rank of  $T$  could be smaller than four for this ansatz and this conditions binds together the values of  $\kappa$  and  $G$ .
3. These extremals have  $CP_2$  projection which in the generic case is 2-D Lagrangian sub-manifold  $Y^2$ . Again one could assume Hamilton-Jacobi coordinates for  $X^4$ . For  $CP_2$  one could assume Darboux coordinates  $(P_i, Q_i)$ ,  $i = 1, 2$ , in which one has  $A = P_i dQ^i$ , and that  $Y^2 \subset CP_2$  corresponds to  $Q_i = \text{constant}$ . In principle  $P_i$  would depend on arbitrary manner on  $M^4$  coordinates. It might be more convenient to use as coordinates  $(u, v)$  for  $M^2$  and  $(P_1, P_2)$  for  $Y^2$ . This covers also the situation when  $M^4$  projection is not 4-D. By its 2-dimensionality  $Y^2$  allows always a complex structure defined by its induced metric: this complex structure is not consistent with the complex structure of  $CP_2$  ( $Y^2$  is not complex sub-manifold).

Using Hamilton-Jacobi coordinates the pre-image of a given point of  $Y^2$  is a 2-dimensional sub-manifold  $X^2$  of  $X^4$  and defines also 2-D sub-manifold of  $M^4$ . The following picture suggests itself. The projection of  $X^2$  to  $M^4$  can be seen for a suitable choice of Hamilton-Jacobi coordinates as an analog of Lagrangian sub-manifold in  $M^4$  that is as surface for which  $v$  and  $Im(w)$  vary and  $u$  and  $Re(w)$  are constant.  $X^2$  would be obtained by allowing  $u$  and  $Re(w)$  to vary: as a matter fact,  $(P_1, P_2)$  and  $(u, Re(w))$  would be related to each other. The induced metric should be consistent with this picture. This would requires  $g_{uRe(w)} = 0$ .

For the deformations  $Q_1$  and  $Q_2$  would become non-constant and they should depend on the second light-like coordinate  $v$  only so that only  $g_{uu}$  and  $g_{uw}$  and  $g_{u\bar{w}}$   $g_{w,w}$  and  $g_{\bar{w},\bar{w}}$  receive contributions which vanish. This would give rise to the analogs of Virasoro conditions guaranteeing that  $T$  is a tensor of form  $(1,1)$  in both  $M^2$  and  $E^2$  indices and that there are no cross components in the induced metric. A more general formulation states that energy momentum tensor satisfies these conditions. The conditions on  $T$  might be equivalent with the conditions for  $g$  and  $G$  separately.

4. Einstein's equations provide an attractive manner to achieve the vanishing of effective 3-dimensionality of the action. Einstein equations would be second order differential equations and the idea that a deformation of vacuum extremal is in question suggests that the dynamics associated with them is in directions transversal to  $Y^2$  so that only the deformation is dictated partially by Einstein's equations.

5. Lagrangian manifolds do not involve complex structure in any obvious manner. One could however ask whether the deformations could involve complex structure in a natural manner in  $CP_2$  degrees of freedom so that the vanishing of  $g_{ww}$  would be guaranteed by holomorphy of  $CP_2$  complex coordinate as function of  $w$ .

One should get the complex structure in some natural manner: in other words, the complex structure should relate to the geometry of  $CP_2$  somehow. The complex coordinate defined by say  $z = P_1 + iQ^1$  for the deformation suggests itself. This would suggest that at the limit when one puts  $Q_1 = 0$  one obtains  $P_1 = P_1(Re(w))$  for the vacuum extremals and the deformation could be seen as an analytic continuation of real function to region of complex plane. This is in spirit with the algebraic approach. The vanishing of Kähler current requires that the Kähler magnetic field is covariantly constant:  $D_z J^{z\bar{z}} = 0$  and  $D_{\bar{z}} J^{z\bar{z}} = 0$ .

6. One could consider the possibility that the resulting 3-D sub-manifold of  $CP_2$  can be regarded as contact manifold with induced Kähler form non-vanishing in 2-D section with natural complex coordinates. The third coordinate variable- call it  $s$ - of the contact manifold and second coordinate of its transversal section would depend on time space-time coordinates for vacuum extremals. The coordinate associated with the transversal section would be continued to a complex coordinate which is holomorphic function of  $w$  and  $u$ .
7. The resulting thickened magnetic flux tubes could be seen as another representation of Kähler magnetic flux tubes: at this time as deformations of vacuum flux tubes rather than cosmic strings. For this ansatz it is however difficult to imagine deformations carrying Kähler electric field.

### 3.2.6 About the interpretation of the generalized conformal algebras

The long-standing challenge has been finding of the direct connection between the super-conformal symmetries assumed in the construction of the geometry of the "world of classical worlds" (WCW) and possible conformal symmetries of field equations. 4-dimensionality and Minkowskian signature have been the basic problems. The recent construction provides new insights to this problem.

1. In the case of string models the quantization of the Fourier coefficients of coordinate variables of the target space gives rise to Kac-Moody type algebra and Virasoro algebra generators are quadratic in these. Also now Kac-Moody type algebra is expected. If one were to perform a quantization of the coefficients in Laurents series for complex  $CP_2$  coordinates, one would obtain interpretation in terms of  $su(3) = u(2) + t$  decomposition, where  $t$  corresponds to  $CP_3$ : the oscillator operators would correspond to generators in  $t$  and their commutator would give generators in  $u(2)$ .  $SU(3)/SU(2)$  coset representation for Kac-Moody algebra would be in question. Kac-Moody algebra would be associated with the generators in both  $M^4$  and  $CP_2$  degrees of freedom. This kind of Kac-Moody algebra appears in quantum TGD.
2. The constraints on induced metric imply a very close resemblance with string models and a generalization of Virasoro algebra emerges. An interesting question is how the two algebras acting on coordinate and field degrees of freedom relate to the super-conformal algebras defined by the symplectic group of  $\delta M^4_+ \times CP_2$  acting on space-like 3-surfaces at boundaries of  $CD$  and to the Kac-Moody algebras acting on light-like 3-surfaces. It has been conjectured that these algebras allow a continuation to the interior of space-time surface made possible by its slicing by 2-surfaces parametrized by 2-surfaces. The proposed construction indeed provides this kind of slicings in both  $M^4$  and  $CP_2$  factor.
3. In the recent case, the algebras defined by the Fourier coefficients of field variables would be Kac-Moody algebras. Virasoro algebra acting on preferred coordinates would be expressed in terms of the Kac-Moody algebra in the standard Sugawara construction applied in string models. The algebra acting on field space would be analogous to the conformal algebra assignable to the symplectic algebra so that also symplectic algebra is present. Stringy pragmatist could imagine quantization of symplectic algebra by replacing  $CP_2$  coordinates in the expressions of Hamiltonians with oscillator operators. This description would be counterpart for the construction of spinor harmonics in WCW and might provide some useful insights.

4. For given type of space-time surface either  $CP_2$  or  $M^4$  corresponds to Kac-Moody algebra but not both. From the point of view of quantum TGD it looks as that something were missing. An analogous problem was encountered at GRT limit of TGD [?]. When Euclidian space-time regions are allowed Einstein-Maxwell action is able to mimic standard model with a surprising accuracy but there is a problem: one obtains either color charges or  $M^4$  charges but not both. Perhaps it is not enough to consider either  $CP_2$  type vacuum extremal or its exterior but both to describe particle: this would give the direct product of the Minkowskian and Euclidian algebras acting on tensor product. This does not however seem to be consistent with the idea that the two descriptions are duality related (the analog of T-duality).

### 3.3 Under what conditions electric charge is conserved for the modified Dirac equation?

One might think that talking about the conservation of electric charge at 21st century is a waste of time. In TGD framework this is certainly not the case and the following arguments suggests that the conservation of electric charge is the Golden Road to the understanding of the spinorial dynamics.

1. In quantum field theories there are two manners to define em charge: as electric flux over 2-D surface sufficiently far from the source region or in the case of spinor field quantum mechanically as combination of fermion number and vectorial isospin. The latter definition is quantum mechanically more appropriate.
2. There is however a problem. In standard approach to gauge theory Dirac equation in the presence of charged classical gauge fields does not conserve the electric charge: electron is transformed to neutrino and vice versa. Quantization solves the problem since the non-conservation can be interpreted in terms of emission of gauge bosons. In TGD framework this does not work since one does not have path integral quantization anymore. Preferred extremals carry classical gauge fields and the question whether em charge is conserved arises. Heuristic picture suggests that em charge must be conserved. This condition might be actually one of the conditions defining what it is to be a preferred extremal. It is not however trivial whether this kind of additional condition can be posed.

#### 3.3.1 Conditions guaranteing the conservation of em charge

What does the conservation of em charge imply in the case of the modified Dirac equation? The obvious guess that the em charged part of the modified Dirac operator must annihilate the solutions, turns out to be correct as the following argument demonstrates.

1. Em charge as coupling matrix can be defined as a linear combination  $Q = aI + bI_3$ ,  $I_3 = J_{kl}\Sigma^{kl}$ , where  $I$  is unit matrix and  $I_3$  vectorial isospin matrix,  $J_{kl}$  is the Kähler form of  $CP_2$ ,  $\Sigma^{kl}$  denotes sigma matrices, and  $a$  and  $b$  are numerical constants different for quarks and leptons.  $Q$  is covariantly constant in  $M^4 \times CP_2$  and its covariant derivatives at space-time surface are also well-defined and vanish.
2. The modes of the modified Dirac equation should be eigen modes of  $Q$ . This is the case if the modified Dirac operator  $D$  commutes with  $Q$ . The covariant constancy of  $Q$  can be used to derive the condition

$$\begin{aligned}
 [D, Q] \Psi &= D_1 \Psi = 0 \quad , \\
 D &= \hat{\Gamma}^\mu D_\mu \quad , \quad D_1 = [D, Q] = \hat{\Gamma}_1^\mu D_\mu \quad , \quad \hat{\Gamma}_1^\mu = [\hat{\Gamma}^\mu, Q] \quad .
 \end{aligned}
 \tag{3.3.1}$$

Covariant constancy of  $J$  is absolutely essential: without it the resulting conditions would not be so simple.

It is easy to find that also  $[D_1, Q] \Psi = 0$  and its higher iterates  $[D_n, Q] \Psi = 0$ ,  $D_n = [D_{n-1}, Q]$  must be true. The solutions of the modified Dirac equation would have an additional symmetry.



3. The commutator  $D_1 = [D, Q]$  reduces to a sum of terms involving the commutators of the vectorial isospin  $I_3 = J_{kl}\Sigma^{kl}$  with the  $CP_2$  part of the gamma matrices:

$$D_1 = [Q, D] = [I_3, \Gamma_r] \partial_\mu s^r T^{\alpha\mu} D_\alpha \quad (3.3.2)$$

In standard complex coordinates in which  $U(2)$  acts linearly the complexified gamma matrices can be chosen to be eigenstates of vectorial isospin. Only the charged flat space complexified gamma matrices  $\Gamma^A$  denoted by  $\Gamma^+$  and  $\Gamma^-$  possessing charges +1 and -1 contribute to the right hand side. Therefore the additional Dirac equation  $D_1\Psi = 0$  states

$$\begin{aligned} D_1\Psi &= [Q, D]\Psi = I_3(A) e_{Ar} \Gamma^A \partial_\mu s^r T^{\alpha\mu} D_\alpha \Psi \\ &= (e_{+r} \Gamma^+ - e_{-r} \Gamma^-) \partial_\mu s^r T^{\alpha\mu} D_\alpha \Psi = 0 \quad (3.3.3) \end{aligned}$$

The next condition is

$$D_2\Psi = [Q, D]\Psi = (e_{+r} \Gamma^+ + e_{-r} \Gamma^-) \partial_\mu s^r T^{\alpha\mu} D_\alpha \Psi = 0 \quad (3.3.4)$$

Only the relative sign of the two terms has changed. The remaining conditions give nothing new.

4. These equations imply two separate equations for the two charged gamma matrices

$$\begin{aligned} D_+\Psi &= T_+^\alpha \Gamma^+ D_\alpha \Psi = 0 \quad , \\ D_-\Psi &= T_-^\alpha \Gamma^- D_\alpha \Psi = 0 \quad , \\ T_\pm^\alpha &= e_{\pm r} \partial_\mu s^r T^{\alpha\mu} \quad . \end{aligned} \quad (3.3.5)$$

These conditions state what one might have expected: the charged part of the modified Dirac operator annihilates separately the solutions. The reason is that the classical W fields are proportional to  $e_{r\pm}$ .

The above equations can be generalized to define a decomposition of the energy momentum tensor to charged and neutral components in terms of vierbein projections. The equations state that the analogs of the modified Dirac equation defined by charged components of the energy momentum tensor are satisfied separately.

5. In complex coordinates one expects that the two equations are complex conjugates of each other for Euclidian signature. For the Minkowskian signature an analogous condition should hold true. The dynamics enters the game in an essential manner: whether the equations can be satisfied depends on the coefficients  $a$  and  $b$  in the expression  $T = aG + bg$  implied by Einstein's equations in turn guaranteeing that the solution ansatz generalizing minimal surface solutions holds true [K9].
6. As a result one obtains three separate Dirac equations corresponding to the the neutral part  $D_0\Psi = 0$  and charged parts  $D_\pm\Psi = 0$  of the modified Dirac equation. By acting on the equations with these Dirac operators one obtains also that the commutators  $[D_+, D_-]$ ,  $[D_0, D_\pm]$  and also higher commutators obtained from these annihilate the induced spinor field mode. Therefore possibly infinite-dimensional algebra would annihilate the induced spinor fields unless the charged parts of the energy momentum tensor vanish identically.

### 3.3.2 Dirac equation in $CP_2$ as a test bench

What could the conservation of electric charge mean from the point of view of the solutions of the modified Dirac equation? The field equations for the preferred extremals of Kähler action reduce to purely algebraic conditions in the same manner as the field equations for the minimal surfaces in string model. Could something similar happen also for the modified Dirac equation and could the condition on charged part of the Dirac operator help to achieve this?

1. For  $CP_2$  type vacuum extremals the modified Dirac operator vanishes identically for the Kähler action. For volume action it reduces to the ordinary Dirac operator in  $CP_2$  and one can ask whether ordinary Dirac operator could in this case allow solutions with a well-defined em charge. Since also spinor harmonics of the imbedding space are expected to be important and associated with the representations of conformal symmetries assignable to the boundary of light cone involving symplectic group of  $\delta M_{\pm}^4 \times CP_2$ , it would be nice if this construction would work for  $CP_2$ .
2. One can construct the solutions of the ordinary Dirac equation from covariantly constant right-handed neutrino spinor playing the role of fermionic vacuum annihilated by the second half of complexified gamma matrices. Dirac equation reduces to Laplace equation for a scalar function and solution can be constructed from this "vacuum" by multiplying with the spherical harmonics of  $CP_2$  and applying Dirac operator [K39]. Similar construction works quite generally thanks to the existence of covariantly constant right handed neutrino spinor. Spherical harmonics of  $CP_2$  are only replaced with those of space-time surface possessing either hermitian structure of Hamilton-Jacobi structure (corresponding to Euclidian and Minkowskian signatures of the induced metric (Appendix)).
3. A good guess is that holomorphy codes the statement that only spinor harmonics of form  $(n, 0)$  and  $(0, n)$  should be allowed. The first problem is that these modes are not actually holomorphic since color triplet partial waves are proportional to  $1/\sqrt{1 + |\xi^1|^2 + |\xi^2|^2}$ : The are good hopes that covariant derivative containing also a term proportional to Kähler gauge potential and coupling to leptons and quarks differently takes care of this.

Dirac equation in  $CP_2$  allows only modes with  $(m, m+3)$ ,  $(m+3, m)$  for leptons and anti-leptons and modes  $(m+1, m)$  and  $(m, m+1)$  for quarks. More general solutions could be possible but would not be global solutions. If this picture is correct, the dynamics in fermionic degrees of freedom would be extremely restricted and only only very few color partial waves would survive.

4. Most holomorphic and anti-holomorphic modes for leptons and quarks would represent gauge degrees of freedom. The remaining three modes for quarks could be interpreted in terms of color of ground state. At first this looks good since only color neutral leptons and color triplet quarks would be allowed. This result just what has been observed and the experimental absence has indeed a challenge for quantum TGD. The experimental absence of higher modes would be due to Kac-Moody gauge invariance.

Lepto-pion hypothesis in its original form and postulating color octet leptons would be however wrong. This might not be a catastrophe: a variant of this hypothesis identifies lepto-pion as quark antiquark pair associated with scaled down variant of hadron physics [?].

5. A further work described in the sequel however shows that the correct identification of partial waves of imbedding space spinors is in terms of cm degrees of freedom of the partonic 2-surface and can be assigned to the super-symplectic conformal invariance dictating the ground states of Super-Kac-Moody representations. There is therefore no need to modify the earlier well-tested picture.

### 3.3.3 How to satisfy the conditions guaranteeing the conservation of em charge?

There are two manners to satisfy the conditions guaranteeing the conservation of em charge leading to three separate Dirac equations. The first option is inspired by string model and solutions are annihilated either by second charged gamma matrix or holomorphic covariant derivative or by the conjugates of these. For the second option the charged modified gamma matrices vanish identically.

### Holomorphy of the solutions

In string model holomorphy/antiholomorphy for the modes of the induced spinor field is essential from the point of view of Super-Virasoro conditions. For preferred extremals the holomorphy seems to be in a key role and it would not be surprising if this were the case also in the fermionic sector. Could the additional Dirac equations associated with charged parts of the modified Dirac operator be solved by a generalization of holomorphy or anti-holomorphy? For the second charged Dirac operator - say  $D_+$  - complexified gamma matrices would annihilate spinor mode and for the second one - say  $D_-$  - holomorphic covariant derivative would annihilate the spinor. Note that the gamma matrices  $\Gamma_+$  and  $\Gamma_-$  are hermitian conjugates of each other.

The condition that either charged gamma matrix annihilates the spinor mode for the space-time sheet in question requires super-symmetry. For  $CP_2$  one has this kind of supersymmetry but covariant constancy allows only right handed neutrino spinor: in this case however both holomorphic gamma matrices annihilate the spinor. In super-string models in flat target space, one has maximal supersymmetry allowing maximal number of covariantly constant spinor modes. For modified gamma matrices this kind of situation might be realized. If one allows the restriction of the induced spinor fields to string world sheets or partonic 2-surfaces, the situation simplifies further, and it might be possible to assume holomorphy in the complex coordinate parametrizing the 2-surface.

Either  $\Gamma_+$  or  $\Gamma_-$  should annihilate the spinor mode. For right-handed neutrino second half of complexified gamma matrices annihilate it. This condition is analogous to the condition that fermionic annihilation operators annihilate the state. In the recent case the condition is weaker since only single complexified gamma matrix annihilates the state. For  $CP_2$  Dirac operator one obtains four basic solutions corresponding to  $\nu_R, \Gamma_+\nu_R, \Gamma_0\nu_R, \Gamma_0\Gamma_+\nu_R$ .  $\Gamma_0$  is the second holomorphic complexified gamma matrix. Therefore it seems that one might be able to obtain at least two charged states for both quarks and lepton as required by the standard model plus possible higher color partial waves.

A stronger condition is that both  $\Gamma_+$  and  $\Gamma_-$  vanish and Dirac operator reduces to neutral Dirac operator acting on complex coordinate and its conjugate. If the vanishing of  $\Gamma_+$  or  $\Gamma_-$  takes place everywhere the energy momentum tensor must be effectively 2-dimensional. This option has been proposed earlier as a solution ansatz. If the vanishing occurs only at 2-D surface, effective 2-dimensionality holds true only at this surface. This option looks more plausible one.

### Option for which charged parts of energy momentum tensor vanish

The vanishing of the charged parts of the modified Dirac operator  $D$  - or equivalently, those of the energy momentum tensor - would reduce  $D$  to its neutral part and the conditions would trivialize. There would be no need for the full holomorphy, which could be an un-physical condition for  $CP_2$  and not favored if one assumes that all color partial waves in  $CP_2$  correspond to physical states in the construction of representations of the symplectic conformal algebra. On the other hand, the reduction of allowed modes to just the observed one (singlet for leptons and triplet for quarks) is an attractive property. In string models one would speak about super-symmetry breaking. Note that holomorphy in the remaining neutral complex or hyper-complex coordinate could provide elegant solution of the modified Dirac equation exactly in the same manner as it does in string models.

It is however not at all clear whether the charged part of the energy momentum tensor can vanish everywhere. Note however that since imbedding space projections of the energy momentum tensor are in question, the conditions do not mean reduction of the rank of energy momentum tensor to at most two. The possibility that the vanishing occurs only at 2-D surfaces analogous to string world sheets and that induced spinor fields must be restricted to these, is consistent with the existent vision

One can study the option allowing non-vanishing charged Dirac operators and requiring holomorphy, covariant constancy, and extended supersymmetry in more detail. To get some perspective one can study the situation in the case of  $CP_2$  type vacuum extremals. In this case the energy momentum tensor and therefore also modified gamma matrices vanish identically. Therefore the situation trivializes and one might hope that for the deformations of  $CP_2$  type vacuum extremals the charged parts of the modified Dirac operator vanish or that holomorphy makes sense.

### 3.3.4 Could the solutions of the modified Dirac equation be restricted to 2-D surfaces?

The condition that the charged Dirac operators (and also neutral one) annihilate physical states is rather strong. If the charged parts  $T_{\pm}^{\alpha}$  of the energy momentum tensor vanish, these conditions apply only to the space-time surface. These conditions are however quite strong and the question is whether one could require them for 2-D sub-manifolds of space-time surface- the analogs of string world sheets- only, and assume that the modes of Dirac equation are restricted on these.

There are several other manners to end up with this view.

1. The vision inspired by the finite measurement resolution is that the solutions of the modified Dirac equation are singular and restricted to 2-dimensional surfaces identifiable as string world sheets in Minkowskian signature and as partonic 2-surfaces in Euclidian signature. For 3-D light-like surfaces solutions would be restricted at world lines defining strands of braid defining discretization as space-time correlate for the finite measurement resolution. The interesting self-referential aspect would be that physical system itself would define the finite measurement resolution.
2. Another interpretation is in terms of the number theoretical vision [K72]. Space-time surfaces define associative or co-associative 4-surfaces with tangent space allowing quaternionic or co-quaternionic structure or its Minkowskian variant. This is a formulation for the idea that classical dynamics is determined by associativity condition. One can however go further and require also commutativity or co-commutativity and this leads to string world sheets or partonic 2-surfaces. The vanishing of the charged components of the energy momentum tensor could be indeed seen as a condition stating that the surface is complex or co-complex sub-manifold (or hyper-complex or co-hyper-complex one).
3. Also strong form of holography leads to the idea that 2-D partonic surfaces or string world sheets and the 4-D tangent space data at them should be enough for the formulation of quantum theory and 4-D space-time surfaces are necessary only for the realization of quantum classical correspondence. One could say that space-time surface is analogous to phase space and that in quantum theory only 2-D slice of it analogous to Lagrangian sub-manifold can be used.

The general vision about preferred extremals involves a non-trivial aspect not yet mentioned [K9] and this allows to develop an argument in favor of reduction of spinorial dynamics to that at 2-D surfaces.

1. Various conserved currents are suggested to define integrable flows meaning that one can identify a global coordinate varying along the flow lines. Could the charged parts of the energy momentum tensor defined as currents define Beltrami flow? If so, these currents have expression of form  $J_{\pm} = \Phi_{\pm} \nabla \Psi_{\pm}$ , where  $\Phi_{\pm}$  and  $\Psi_{\pm}$  are complex scalar functions such that the latter ones define the global coordinate. If this is the case, then the surface at which  $J_{\pm}$  vanishes corresponds to the surface  $\Phi_{+} = \bar{\Phi}_{-} = 0$  and by complex valuedness of  $\Phi_{\pm} = 0$  is 2-dimensional rather than 0-dimensional as for a generic vector field. The charged parts of energy momentum tensor vanish identically as do the corresponding modified gamma matrices.
2. Vanishing of  $\Phi_{\pm}$  would reduce the 4-D conformal algebra to 2-dimensional conformal algebra associated with the string world sheet or partonic 2-surface, and this is just what is expected on basis of physical intuition. One could say that locally space-time surface reduces to effectively 2-D surface. Charge conservation would select 2-dimensional string world sheets and/or partonic 2-surfaces and reproduce the earlier picture inspired by the notion of finite measurement resolution, by number theoretical considerations, and by strong form of holography.

A couple of further comments about are in order.

1. A natural consistency condition is that the modified gamma matrices in the modified Dirac operator are parallel to the 2-D surface. Otherwise one obtains covariant derivatives in transversal direction giving delta functions. This requires that modified gamma matrices generate a 2-D subspace tangential to  $X^2$  at  $X^2$ . This condition need not hold true elsewhere. This would mean

that with respect to the effective metric defined by the anticommutators of the modified gamma matrices space-time surface becomes effectively 2-dimensional locally. Effective 2-dimensionality of the effective metric was conjectured already earlier but now it is restricted to string world sheets and partonic 2-surfaces thus appearing as singularities of the preferred extremals. String world sheets and partonic 2-surfaces must obey some dynamics and minimal surface equation in the effective metric is a good guess since it automatically would reduce the situation to 2-D one.

2. Weak form of electric magnetic duality states that at partonic 2-surface  $X^2$  the Kähler electric field strength  $J^{n\beta}$  in 2-dimensional tangent plane of  $X^4$  transversal to  $X^2$  is proportional to the 4-D dual of the Kähler magnetic field strength  $J_{\alpha\beta}$  at  $X^2$  :  $J^{n\beta} = k\epsilon^{n\beta\gamma\delta}J_{\gamma\delta}$  ,  $k = \text{constant}$ . The transversal plane is not unique without some additional condition and the natural condition is that it defines tangent plane to the string world sheet.

### 3.3.5 The algebra spanned by the modified Dirac operators

The conservation of em charge for the modified Dirac equation implies that the electromagnetic charge determined defined as  $Q = aI + bI_3$  is conserved in the classical electro-weak gauge fields identified as induced gauge fields. This condition is highly non-trivial and as has been found could hold true only at 2-D surfaces implying a stringy localization of fermions.

For the modified Dirac equation additional consistency conditions analogous to Super-Virasoro conditions follow from the conditions that electromagnetic charge is constant for the modes of the modified Dirac equation. The conditions state that the possibly infinite-dimensional algebra or super-algebra generated by the neutral part and two charged parts with charges  $\pm 1$  of the modified Dirac operator annihilates the preferred solutions of the modified Dirac equation.

For super-algebra option one would start with anti-commutators of the Dirac operators and consider commutators when either generators has even value of em charge. For algebra option one would consider only commutators which are formally Lie commutators of gamma matrix valued vector fields  $\Gamma_i^\alpha D_\alpha$  which ordinary derivatives replaced with covariant derivatives and components of the vector fields replaced with the modified gamma matrices obtained by contracting the neutral or charged part of the energy momentum tensor with flat space gamma matrices.

The commutator is the more feasible option as following arguments show.

1. Ordinary modified Dirac equation gives rise to a conserved fermionic current and its conservation could be seen as a consequence of the modified Dirac equation. The statement that the modified Dirac operators annihilate the induced spinors could thus be equivalent with the statement that SU(2) triplet of fermionic currents is conserved. In old fashioned hadron physics this corresponds to conserved vector current hypothesis.
2. The algebra defined by the commutators has the structure of vectorial SU(2) algebra and the natural guess is that this algebra relates closely to  $\mathcal{N} = 2$  super-conformal algebra for which super-generators  $G$  form SU(2) triplets and which allows conserved U(1) currents besides energy momentum tensor.

In the recent case the U(1) charge would be em charge. As a matter fact,  $\mathcal{N} = 2$  algebra is accompanied also by SU(2) algebra of conserved currents and the attractive interpretation is that the Dirac operators generate this algebra.

3. The algebra of Dirac operators annihilating the induced spinor field would define algebra of divergences of fermionic currents of form  $J_i^\alpha = \bar{\Psi}\Gamma_i^\alpha\Psi$ . These currents are conserved if the modified Dirac equations are satisfied. The algebra generated by the commutators of these fermionic currents assuming anti-commutation relations for the induced spinor fields should be equivalent with the algebra of Dirac operators. This should fix the anti-commutation relations for the induced spinor fields.
4. The outcome is a bosonic algebra of vector currents. By replacing  $\bar{\Psi}$  or  $\Psi$  with a mode of the induced spinor field one would obtain super-algebra generators of extended super-algebra. The divergences of fermionic and bosonic generators would generate algebra which vanishes identically for the solutions of the modified Dirac equation. The currents themselves would be non-vanishing.

5. If the charged currents vanish at 2-surface then the commutator of charged Dirac operator vanishes identically. The commutators of neutral and charged Dirac operators need not vanish identically and it might be necessary to pose this as an additional conditions. The vanishing conditions reduce to the vanishing of the ordinary commutator  $[T_0, T_{\pm}]$  of vector fields  $T_0$  and  $T_{\pm}$ .

What about the super algebra part of the Super-Virasoro algebra. Is it also present?

1. One must notice that it is the "gamma matrix fields" defined by neutral and charged parts of the modified gamma matrices  $\Gamma_i^A$  forming an  $SU(2)$  triplet and these anti-commute classically to parts of the modified metric for which certain parts should vanish. These "certain parts" should vanish also for the induced metric resulting as anti-commutators of the induced gamma matrices. The conditions are not expected to be independent and should correspond to Virasoro conditions for the induced metric.
2. The  $SU(2)$  Super Virasoro algebra discussed above would naturally relate to  $\mathcal{N} = 2$  variant of the ordinary Super-Virasoro algebra and electromagnetic charge would take the role of conserved  $U(1)$  current accompanying  $\mathcal{N} = 2$  algebra. This algebra indeed involves  $SU(2)$  as an additional symmetry algebra. Modified Dirac equations would correspond to conservation of the  $SU(2)$  currents and the vanishing conditions on the induced metric and/or its analog defined by the anti-commutators of the modified gamma matrices would correspond to Virasoro conditions. It is however not clear whether the modified gamma matrices - or rather, their second quantized variants - should annihilate the physical states. This condition would correspond for the induced spinor fields a condition stating that second half of complexified modified gamma matrices annihilates the right handed neutrino spinor serving as the analog of fermionic Fock vacuum.

### 3.3.6 Connection with the number theoretical vision about field equations

The recent progress in the understanding of preferred extremals of Kähler action suggests also an interesting connection to the number theoretic vision about field equations [K72]. In particular, it might be possible to understand how one can have Hermitian/Hamilton-Jacobi structure simultaneously with quaternionic structure and how quaternionic structure is possible for the Minkowskian signature of the induced metric.

One can imagine two manners of introducing octonionic and quaternionic structures. The first one is based on the introduction of octonionic representation of gamma matrices and second on the notion of octonion real-analycity.

1. If quaternionic structure is defined in terms of the octonionic representation of the imbedding space gamma matrices, there seems to be no obvious problems since one considers automatically complexification of quaternions represented in terms of gamma matrices. For the approach based on the notion of quaternion real analyticity, one is forced to use Wick rotation to define the quaternionic structure in Minkowskian regions or to introduce what I have called hyper-quaternionic structure by imbedding the space-time surface to a sub-space  $M^8$  of complexified octonions. This is admittedly artificial.
2. The octonionic representation effectively replaces  $SO(7,1)$  as tangent space group with  $G_2$  and means selection of preferred  $M^2 \subset M^4$  having interpretation complex plane of octonionic space. A more general condition is that the tangent space of space-time surface at each point contains preferred sub-space  $M^2(x) \subset M^4$  forming an integrable distribution. The same condition is involved with the definition of Hamilton-Jacobi structure. What puts bells ringing is that the modified Dirac equation for the octonionic representation of gamma matrices allows the conservation of electromagnetic charge in the proposed sense a observed for years ago. One can ask whether the conditions on the charged part of energy momentum tensor could relate to the reduction of  $SO(7,1)$  to  $G_2$ .
3. Octonionic gamma matrices appear also in the proposal stating that space-time surfaces are quaternionic in the sense that tangent space of the space-time surface is quaternionic in the sense that induced octonionic gamma matrices generate a quaternionic sub-space at a given point of space-time time. Besides this the already mentioned additional condition stating that

the tangent space contains preferred sub-space  $M^2 \subset M^4$  or integrable distribution of this kind of sub-spaces is required. It must be emphasized that induced rather than modified gamma matrices are natural in these conditions.

**Definition of quaternionicity based on gamma matrices**

The definition of quaternionicity in terms of gamma matrices looks more promising. This however raises two questions.

1. Can the quaternionicity of the space-time surface together with a preferred distribution of tangent planes  $M^2(x) \subset M^4$  or  $E^2(x) \subset CP_2$  be equivalent with the reduction of the field equations to the analogs of minimal surface equations stating that certain components of the induced metric in complex/Hamilton-Jacobi coordinates vanish in turn guaranteeing that field equations reduce to algebraic identities following from the fact that energy momentum tensor and second fundamental form have no common components? This should be the case if one requires that the two solution ansätze are equivalent.
2. Can the conditions for the modified Dirac equation select complex or co-complex 2-sub-manifold of space-time surface identified as quaternionic or co-quaternionic 4-surface? Could the conditions stating the vanishing of charged energy momentum currents state that the spinor fields are localized to complex or co-complex (hyper-complex or co-hypercomplex) 2-surfaces?

One should assign to the space-time sheets both quaternionic and Hermitian or Hamilton-Jacobi structure. There are two structures involved. Euclidian metric is an essential aspect of what it is to be quaternionic or octonions. It however seems that one can assign to the induced metric only Hermitian or Hamilton-Jacobi structure. This leads to a series of innocent questions.

1. Could these two structures be associated with canonical momentum currents and metric respectively? Anti-commutators of the modified gamma matrices define an effective metric expressible in terms of canonical momentum currents as

$$G^{\alpha\beta} = \Pi_k^\alpha \Pi^{\beta k} .$$

Here  $\Pi_k^\alpha = \partial L / \partial_\alpha h^k$  is the canonical momentum current. This effective metric should have a deep physical and mathematical meaning but this meaning has remained a mystery.

2. Could  $G$  be assigned with the quaternionic structure and induced metric to the Hermitian/Hamilton-Jacobi structures? Or perhaps vice versa? Could the neutral and charged components of the energy momentum tensor somehow correspond to quaternionic units?

The basic potential problem with the assignment of quaternionic structure to the induced gamma matrices is the signature of the metric in Minkowskian regions.

1. If quaternionic structures is defined in terms of the octonionic representation of the imbedding space gamma matrices, there seems to be no obvious problems since one considers automatically complexification of quaternions.
2. For the approach based on the notion of quaternion real analyticity, one is forced to use Wick rotation to define the quaternionic structure or to introduce hyper-quaternionic structure by imbedding the space-time surface to a sub-space  $M|_{\text{sup}_i} \otimes S_i / \text{sup}_i$  of complexified octonions. This is admittedly artificial.

Could one pose the additional requirement that the signature of the effective metric  $G$  defined by the modified gamma marices (and to be distinguished from Einstein tensor) is Euclidian in the sense that all four eigenvalues of this tensor would have same sign.

1. For the induced metric the projections of gamma matrices are given by

$$\Gamma_\alpha = \Gamma^a e_{a\alpha} , \quad e_{a\alpha} = e_{ak} \partial_\alpha h^k .$$

For the modified gamma matrices their analogs would be given by

$$\Gamma^\alpha = \Gamma^a E_a^\alpha \quad , \quad E_a^\alpha = e_a^k \Pi_k^\alpha \quad .$$

One cannot induce  $G$  from any metric defined in the imbedding space but the notion of tangent space quaternionicity is well-defined.

2. What quaternionic structure for  $G$  could mean? One can imagine several options.

- (a) For the ordinary complex structure metric has vanishing diagonal components and the inner product for infinitesimal vectors is just  $g_{z\bar{z}}(dz_1 d\bar{z}_2 + dz_2 d\bar{z}_1)$ . Could this formula generalize to  $g_{Q\bar{Q}}(dQ_1 d\bar{Q}_2 + dQ_2 d\bar{Q}_1)$ ? The generalization would be a direct generalization of conformal invariance to 4-D context stating that 4-metric is quaternion-conformally equivalent to flat metric. This would give additional strong condition on energy momentum tensor:

$$G = \Pi_k^\alpha \Pi^{\beta k} = T^2 \delta_{\alpha\beta} \quad .$$

The proportionality to Euclidian metric means in Minkowskian realm that the  $G$  is of form  $G = T^2(2u_\alpha u_\beta - g_{\alpha\beta})$ . Here  $u$  is time-like vector field satisfying  $u^\alpha u_\alpha = 1$  and having interpretation as a local four-velocity (in Robertson-Walker cosmology similar situation is encountered). The eigen value problem in the form  $G_\beta^\alpha x^\beta = \lambda x^\alpha$  makes sense and eigenvectors would be  $u^\alpha$  with eigenvalue  $\lambda = T^2$  and three vectors orthogonal to it with eigenvalue  $-T^2$ . This requires integrable flow defined by  $u$  and defining a preferred time coordinate. In number theoretic vision this kind of time coordinate is introduced and corresponds to the direction assignable to the octonionic real unit. Note that the vanishing of charged projections of the energy momentum tensor does not imply a reduction of the rank of  $T$  so that this options might work.

- (b) Quaternionicity could mean also the structure of hyper-Kähler manifold. Metric and Kähler form for Kähler manifold are generalized to metric representing quaternion real unit and three covariantly constant Kähler forms  $I_i$  obeying the multiplication rules for quaternions. The necessary condition is that the holonomy group equals to  $SU(2)$  identifiable as automorphism group of quaternions. One can also define quaternionic structure: there would exist three antisymmetric tensors, whose squares give the negative of the metric.  $CP_2$  allows quaternionic structure in this sense and only one of these forms is covariantly constant.

Could space-time surface allow Hyper-Kähler or quaternionic structure somehow induced from that of  $CP_2$ ? This does not work for  $G$ .  $G$  is quadratic in energy momentum tensor and therefore involves four power of  $J$  rather than being square of projection of  $J$  or two other quaternionic imaginary units of  $CP_2$ . One can of course ask whether the induced quaternionic units could obey the multiplication of quaternionic units and have same square given by the projection of  $CP_2$  metric. In this case  $CP_2$  metric would define the effective metric and would be indeed Euclidian. For the ansatz for preferred extremals with Minkowskian signature  $CP_2$  projection is at most 3-dimensional but also in this case the imaginary units might allow a realization as projections.

### Definition of quaternionicity based on octonion real-analyticity

Second definition of quaternionicity is on more shaky basis and motivated by the solutions of 2-D Laplace equation: quaternionic space-time surfaces would be obtained as zero loci of octonion real-analytic functions. Unfortunately octonion real-analyticity does not make sense in Minkowskian signature.

One could understand octonion real-analyticity in Minkowskian signature if one could understand the deeper meaning of Wick rotation. Octonion real analyticity formulated as a condition for the vanishing of the imaginary part of octonion real-analytic function makes sense for in octonionic coordinates for  $E^4 \times CP_2$  with Euclidian signature of metric.  $M^4 \times CP_2$  is however only a subspace of complexified octonions and not closed with respect to multiplication so that octonion real-analytic functions do not make sense in  $M^4 \times CP_2$ . Wick rotation should transform the solution candidate



defined by an octonion real-analytic function to that defined in  $M^4 \times CP_2$ . A natural additional condition is that Wick rotation should reduce to that taking  $M^2 \subset M^4$  to  $E^2 \subset E^4$ .

The following trivial observation made in the construction of Hamilton-Jacobi structure in  $M^4$  with Minkowskian signature of the induced metric (see the Appendix) as a Wick rotation of Hermitian structure in  $E^4$  might help here.

1. The components of the metric of  $E^2$  in complex coordinates  $(z, \bar{z})$  for  $E^2$  are given by  $g_{w\bar{w}} = -1$  whereas the metric of  $M^2$  in light-like coordinates  $(u = x+t, v = x-t)$  is given by  $g_{uv} = -1$ . The metric is same and  $M^2$  and  $E^2$  correspond only to different interpretations for the coordinates! One could say that  $M^4 \times CP_2$  and  $E^4 \times CP_2$  have same metric tensor, Kähler structure, and spinor structure. Since only these appear in field equations, one could hope that the solutions of field equations in  $M^4 \times CP_2$  and  $E^4 \times CP_2$  are obtained by Wick rotation. This for preferred extremals at least and if the field equations reduce to purely algebraic ones.
2. If one accepts the proposed construction of preferred extremals of Kähler action discussed in [?], the field equations indeed reduce to purely algebraic conditions satisfied if space-time surface possesses Hermitian structure in the case of Euclidian signature of the induced metric and Hamilton-Jacobi structure in the case of Minkowskian signature. Just as in the case of minimal surfaces, energy momentum tensor and second fundamental form have no common non-vanishing components. The algebraization requires as a consistency condition Einstein's equations with a cosmological term. Gravitational constant and cosmological constant follow as predictions.
3. If Wick rotation in the replacement of  $E^2$  coordinates  $(z, \bar{z})$  with  $M^2$  coordinates  $(u, v)$  makes sense, one can hope that field equations for the preferred extremals hold true also for a Wick rotated surfaces obtained by mapping  $M^2 \subset M^4$  to  $E^2 \subset E^4$ . Also Einstein's equations should be satisfied by the Wick rotated metric with Euclidian signature.
4. Wick rotation makes sense also for the surfaces defined by the vanishing of the imaginary part (complementary to quaternionic part) of octonion real-analytic function. Therefore one can hope that this ansatz could work. Wick rotation is non-trivial geometrically. For instance, light-like lines  $v = 0$  of hyper-complex plane  $M^2$  are taken to  $\bar{z} = 0$  defining a point of complex plane  $E^2$ . Note that non-invertible hyper-complex numbers correspond to the two light-like lines  $u = 0$  and  $v = 0$  whereas non-invertible complex numbers correspond to the origin of  $E^2$ .
5. If the conjecture holds true, one can apply to both factors in  $E^4 = E^2 \times E^2$  and to get preferred extremals in  $M^{2,2} \times CP_2$ . Minkowski space  $M^{2,2}$  is essential in twistor approach and the possibility to carry out Wick rotation for preferred extremals could justify Wick rotation in quantum theory.

### 3.3.7 Modification of the measurement interaction term

By quantum classical correspondence the momenta and other quantum numbers should have correlates in the geometry of the space-time sheet. This suggests an inclusion to the modified Dirac action of a general coordinate invariant measurement interaction term invariant under appropriate subgroup of isometries characterizing the choice of the measurement axis. In the following only the measurement interaction term assignable to four-momentum is discussed. One could assign this term only to 3-D space-like ends of space-time surface and the light-like wormhole throats. Somewhat surprisingly the effective gauge character of this term allows also the assignment to space-time interior.

The first guess for the measurement interaction term for 4-momentum would be as  $\lambda \bar{\Psi} \Gamma^\alpha p_\alpha \Psi$  restricted to 3-D preferred surface in question. This term however vanishes at the light-like orbits of wormhole throats since the modified gamma matrices defined by the Chern-Simons term contain only  $CP_2$  gamma matrices. This forced to replace the term with  $\lambda \bar{\Psi} \gamma^k p_k \Psi$  in the original approach [?]. This term does not possess a formal gauge character and treats  $M^4$  and  $CP_2$  asymmetrically. Second problem is that measurement interaction term is proportional to a constant  $\lambda$  with dimensions of mass and unless one can relate it to gravitational constant, is un-natural.

As already noticed, the measurement interaction term formally corresponds to a gauge transform of Kähler gauge potential by the gradient  $p_\alpha = p_k \partial_\alpha m^k$  defining the momentum projection. The change of the gauge eliminating this term introduces plane wave factor to the induced spinor field. The gauge transformation eliminating the measurement interaction term does not become trivial asymptotically

and might therefore carry physical information. Therefore one can consider also the possibility that measurement interaction term is introduced at the entire 4-D space-time sheet. In this case the change of gauge by a phase transformation introducing a plane-wave factor would lead to the equation without measurement interaction term and one would obtain holomorphic solutions.

Consider now the 4-D option in more detail.

1. One can argue that the measurement interaction term in the interior can be transformed away by a gauge transformation  $A_\alpha \rightarrow A_\alpha - p_\alpha$  so that the holomorphic solutions are not lost. The global nature of the gauge transformation gives hopes that it indeed codes information via the plane wave phase multiplying the holomorphic solutions. The projection  $p_\alpha$  appearing in the contraction with the modified gamma matrices is automatically parallel to the tangent space of the string world sheet or partonic 2-surface.
2. The question whether there is a connection between gravitational and ordinary Planck constants led to the conjecture that the gravitational momentum squared defined by the modified gamma matrices would be equal to inertial momentum squared [K25] just as Equivalence Principle requires. In other words, the gravitational longitudinal 2-momentum squared  $p_{gr}^2 = g_{eff}^{\alpha\beta} p_\alpha p_\beta$  would be equal to the inertial 2-momentum squared  $p_I^2 = m_2^{kl} p_k p_l$  at respective tangent spaces  $M^2$  resp.  $E^2$  of string world sheet resp. partonic 2-surface. At the ends of braid strands defining the intersections of string world sheets and partonic 2-surfaces, one would have

$$p_{gr}^2 = g_{eff,s}^{\alpha\beta} p_\alpha p_\beta + g_{eff,p}^{\alpha\beta} p_\alpha p_\beta = p^2 .$$

Here the subscripts 's' and 'p' refer to string world sheet and partonic 2-surface respectively.

3. It would be nice if this condition would somehow follow from the proposed field equation for the induced spinors at the edges of string world sheet, where one should treat the gauge conditions carefully without doing the gauge transformation. At the intersection point it would seem necessary to assume that the ordinary derivatives - maybe even covariant derivatives - vanish. If covariant derivatives vanish, the modified Dirac equation in 4-D sense would reduce to the condition that the sum of the measurement interaction terms annihilates the spinor modes. This would give

$$\Gamma^\alpha p_\alpha \Psi = 0$$

at the ends of braid strands and this would give massless condition in 4-D sense stating  $p_{gr,||}^2 + p_{gr,\perp}^2 = 0$ .

4. The modified Dirac equation contains a boundary term  $\Gamma^n \Psi$  at the boundaries of the string world sheet. The vanishing of  $\Gamma^n$  proportional to the canonical momentum current in the normal direction at wormhole throats could be forced by the condition that classical charges do not leak between Minkowskian and Euclidian regions of the space-time sheet. This condition cannot be posed at space-like 3-surfaces since they represent initial data.

To sum up, this option is favored because no dimensional coupling is needed and because one obtains a connection between ordinary Planck constant and gravitational Planck constant as discussed in [K25]. Also a close connection with braid picture and generalized Feynman diagrams with lines identified as massless wormhole throats emerges.

### 3.4 Preferred extremals and solutions of the modified Dirac equation and super-conformal symmetries

The new vision about preferred extremals and modified Dirac equations is bound to check the existing vision about super-conformal symmetries. One important discovery is that Einstein's equations follow from the vanishing of terms proportional to Kähler current in field equations for preferred extremals and Equivalence Principle at the classical level is realized automatically in all scales in contrast to

the earlier belief. This obviously must have implications to the general vision about Super-Virasoro representations and one must be ready to modify the existing picture based on the assumption that quantum version of Equivalence Principle is realized in terms coset representations.

The very special role of right handed neutrino is also bound to have profound implications. A further important outcome is the identification of gauge potentials as duals of Kac-Moody currents at the boundaries of string world sheets: quantum gauge potentials are defined only where they are needed that is the curves defining the non-integrable phase factors. This gives also rise to the realization of the conjecture Yangian in terms of the Kac-Moody charges and commutators in accordance with the earlier conjecture.

### 3.4.1 Super-conformal symmetries

It is good to summarize first the basic ideas about Super-Virasoro representations. TGD allows two kinds of super-conformal symmetries.

1. The first super-conformal symmetry is associated with  $\delta M_{\pm}^4 \times CP_2$  and corresponds to symplectic symmetries of  $\delta M_{\pm}^4 \times CP_2$ . The reason for extension of conformal symmetries is metric 2-dimensionality of the light-like boundary  $\delta M_{\pm}^4$  defining upper/lower boundary of causal diamond ( $CD$ ). This super-conformal symmetry is something new and corresponds to replacing finite-dimensional Lie-group  $G$  for Kac-Moody symmetry with infinite-dimensional symplectic group. The light-like radial coordinate of  $\delta M_{\pm}^4$  takes the role of the real part of complex coordinate  $z$  for ordinary conformal symmetry. Together with complex coordinate of  $S^2$  it defines 3-D restriction of Hamilton-Jacobi variant of 4-D super-conformal symmetries. One can continue the conformal symmetries from light-cone boundary to  $CD$  by forming a slicing by parallel copies of  $\delta M_{\pm}^4$ . There are two possible slicings corresponding to the choices  $\delta M_+^4$  and  $\delta M_-^4$  assignable to the upper and lower boundaries of  $CD$ . These two choices correspond to two arrows of geometric time for the basis of zero energy states in ZEO.
2. Super-symplectic degrees of freedom determine the electroweak and color quantum numbers of elementary particles. Bosonic emergence implies that ground states assignable to partonic 2-surfaces correspond to partial waves in  $\delta M_{\pm}^4$  and one obtains color partial waves in particular. These partial waves correspond to the solutions for the Dirac equation in imbedding space and the correlation between color and electroweak quantum numbers is not quite correct. Super-Kac-Moody generators give the compensating color for massless states obtained from tachyonic ground states guaranteeing that standard correlation is obtained. Super-symplectic degrees are therefore directly visible in particle spectrum. One can say that at the pointlike limit the WCW spinors reduce to tensor products of imbedding space spinors assignable to the center of mass degrees of freedom for the partonic 2-surfaces defining wormhole throats.

I have proposed a physical interpretation of super-symplectic vibrational degrees of freedom in terms of degrees of freedom assignable to non-perturbative QCD. These degrees of freedom would be responsible for most of the baryon masses but their theoretical understanding is lacking in QCD framework.

3. The second super-conformal symmetry is assigned light-like 3-surfaces and to the isometries and holonomies of the imbedding space and is analogous to the super-Kac-Moody symmetry of string models. Kac-Moody symmetries could be assigned to the light-like deformations of light-like 3-surfaces. Isometries give tensor factor  $E^2 \times SU(3)$  and holonomies factor  $SU(2)_L \times U(1)$ . Altogether one has 5 tensor factors to super-conformal algebra. That the number is just five is essential for the success p-adic mass calculations [K45, K39].

The construction of solutions of the modified Dirac equation suggests strongly that the fermionic representation of the Super-Kac-Moody algebra can be assigned as conserved charges associated with the space-like braid strands at both the 3-D space-like ends of space-time surfaces and with the light-like (or space-like with a small deformation) associated with the light-like 3-surfaces. The extension to Yangian algebra involving higher multilinears of super-Kac Moody generators is also highly suggestive. These charges would be non-local and assignable to several wormhole contacts simultaneously. The ends of braids would correspond points of partonic 2-surfaces defining a discretization of the partonic 2-surface having interpretation in terms of finite measurement resolution.

These symmetries would correspond to electroweak and strong gauge fields and to gravitation. The duals of the currents giving rise to Kac-Moody charges would define the counterparts of gauge potentials and the conserved Kac-Moody charges would define the counterparts of non-integrable phase factors in gauge theories. The higher Yangian charges would define generalization of non-integrable phase factors. This would suggest a rather direct connection with the twistorial program for calculating the scattering amplitudes implies also by zero energy ontology.

Quantization recipes have worked in the case of super-string models and one can ask whether the application of quantization to the coefficients of powers of complex coordinates or Hamilton-Jacobi coordinates could lead to the understanding of the 4-D variants of the conformal symmetries and give detailed information about the representations of the Kac-Moody algebra too.

### 3.4.2 What is the role of the right-handed neutrino?

A highly interesting aspect of Super-Kac-Moody symmetry is the special role of right handed neutrino.

1. Only right handed neutrino allows besides the modes restricted to 2-D surfaces also the 4D modes delocalized to the entire space-time surface. The first ones are holomorphic functions of single coordinate and the latter ones holomorphic functions of two complex/Hamilton-Jacobi coordinates. Only  $\nu_R$  has the full  $D = 4$  counterpart of the conformal symmetry and the localization to 2-surfaces has interpretation as super-conformal symmetry breaking halving the number of super-conformal generators.
2. This forces to ask for the meaning of super-partners. Are super-partners obtained by adding  $\nu_R$  neutrino localized at partonic 2-surface or delocalized to entire space-time surface or its Euclidian or Minkowskian region accompanying particle identified as wormhole throat? Only the Euclidian option allows to assign right handed neutrino to a unique partonic 2-surface. For the Minkowskian regions the assignment is to many particle state defined by the partonic 2-surfaces associated with the 3-surface. Hence for spartners the 4-D right-handed neutrino must be associated with the 4-D Euclidian line of the generalized Feynman diagram.
3. The orthogonality of the localized and de-localized right handed neutrino modes requires that 2-D modes correspond to higher color partial waves at the level of imbedding space. If color octet is in question, the 2-D right handed neutrino as the candidate for the generator of standard SUSY would combine with the left handed neutrino to form a massive neutrino. If 2-D massive neutrino acts as a generator of super-symmetries, it is in the same role as badly broken supersymmetries generated by other 2-D modes of the induced spinor field (SUSY with rather large value of  $\mathcal{N}$ ) and one can argue that the counterpart of standard SUSY cannot correspond to this kind of super-symmetries. The right-handed neutrinos delocalized inside the lines of generalized Feynman diagrams, could generate  $\mathcal{N} = 2$  variant of the standard SUSY.

#### How particle and right handed neutrino are bound together?

Ordinary SUSY means that apart from kinematical spin factors sparticles and particles behave identically with respect to standard model interactions. These spin factors would allow to distinguish between particles and sparticles. But is this the case now?

1. One can argue that 2-D particle and 4-D right-handed neutrino behave like independent entities, and because  $\nu_R$  has no standard model couplings this entire structure behaves like a particle rather than sparticle with respect to standard model interactions: the kinematical spin dependent factors would be absent.
2. The question is also about the internal structure of the sparticle. How the four-momentum is divided between the  $\nu_R$  and 2-D fermion. If  $\nu_R$  carries a negligible portion of four-momentum, the four-momentum carried by the particle part of sparticle is same as that carried by particle for given four-momentum so that the distinctions are only kinematical for the ordinary view about sparticle and trivial for the view suggested by the 4-D character of  $\nu_R$ .

Could sparticle character become manifest in the ordinary scattering of sparticle?

1. If  $\nu_R$  behaves as an independent unit not bound to the particle, it would continue in the original direction as particle scatters: sparticle would decay to particle and right-handed neutrino. If  $\nu_R$  carries a non-negligible energy the scattering could be detected via a missing energy. If not, then the decay could be detected by the interactions revealing the presence of  $\nu_R$ .  $\nu_R$  can have only gravitational interactions. What these gravitational interactions are is not however quite clear since the proposed identification of gravitational gauge potentials is as duals of Kac-Moody currents analogous to gauge potentials located at the boundaries of string world sheets. Does this mean that 4-D right-handed neutrino has no quantal gravitational interactions? Does internal consistency require  $\nu_R$  to have a vanishing gravitational and inertial masses and does this mean that this particle carries only spin?
2. The cautious conclusion would be following: if delocalized  $\nu_R$  and parton are un-correlated particle and sparticle cannot be distinguished experimentally and one might perhaps understand the failure to detect standard SUSY at LHC. Note however that the 2-D fermionic oscillator algebra defines badly broken large  $\mathcal{N}$  SUSY containing also massive (longitudinal momentum square is non-vanishing) neutrino modes as generators.

### Taking a closer look on sparticles

It is good to take a closer look at the delocalized right handed neutrino modes.

1. At imbedding space level that is in cm mass degrees of freedom they correspond to covariantly constant  $CP_2$  spinors carrying light-like momentum which for causal diamond could be discretized. For non-vanishing momentum one can speak about helicity having opposite sign for  $\nu_R$  and  $\bar{\nu}_R$ . For vanishing four-momentum the situation is delicate since only spin remains and Majorana like behavior is suggestive. Unless one has momentum continuum, this mode might be important and generate additional SUSY resembling standard  $\mathcal{N} = 1$  SUSY.
2. At space-time level the solutions of modified Dirac equation are holomorphic or anti-holomorphic.
  - (a) For non-constant holomorphic modes these characteristics correlate naturally with fermion number and helicity of  $\nu_R$ . One can assign creation/annihilation operator to these two kinds of modes and the sign of fermion number correlates with the sign of helicity.
  - (b) The covariantly constant mode is naturally assignable to the covariantly constant neutrino spinor of imbedding space. To the two helicities one can assign also oscillator operators  $\{a_{\pm}, a_{\pm}^{\dagger}\}$ . The effective Majorana property is expressed in terms of non-orthogonality of  $\nu_R$  and  $\bar{\nu}_R$  translated to the non-vanishing of the anti-commutator  $\{a_{+}^{\dagger}, a_{-}\} = \{a_{-}^{\dagger}, a_{+}\} = 1$ . The reduction of the rank of the  $4 \times 4$  matrix defined by anti-commutators to two expresses the fact that the number of degrees of freedom has halved.  $a_{+}^{\dagger} = a_{-}$  realizes the conditions and implies that one has only  $\mathcal{N} = 1$  SUSY multiplet since the state containing both  $\nu_R$  and  $\bar{\nu}_R$  is same as that containing no right handed neutrinos.
  - (c) One can wonder whether this SUSY is masked totally by the fact that sparticles with all possible conformal weights  $n$  for induced spinor field are possible and the branching ratio to  $n = 0$  channel is small. If momentum continuum is present, the zero momentum mode might be equivalent to nothing.

What can happen in spin degrees of freedom in super-symmetric interaction vertices if one accepts this interpretation? As already noticed, this depends solely on what one assumes about the correlation of the four-momenta of particle and  $\nu_R$ .

1. For SUSY generated by covariantly constant  $\nu_R$  and  $\bar{\nu}_R$  there is no neutrino four-momentum involved so that only spin matters. One cannot speak about the change of direction for  $\nu_R$ . In the scattering of sparticle the direction of particle changes and introduces different spin quantization axes.  $\nu_R$  retains its spin and in new system it is superposition of two spin projections. The presence of both helicities requires that the transformation  $\nu_R \rightarrow \bar{\nu}_R$  happens with an amplitude determined purely kinematically by spin rotation matrices. This is consistent with fermion number conservation modulo 2.  $\mathcal{N} = 1$  SUSY based on Majorana spinors is highly suggestive.

2. For SUSY generated by non-constant holomorphic and anti-holomorphic modes carrying fermion number the behavior in the scattering is different. Suppose that the sparticle does not split to particle moving in the new direction and  $\nu_R$  moving in the original direction so that also  $\nu_R$  or  $\bar{\nu}_R$  carrying some massless fraction of four-momentum changes its direction of motion. One can form the spin projections with respect to the new spin axis but must drop the projection which does not conserve fermion number. Therefore the kinematics at the vertices is different. Hence  $\mathcal{N} = 2$  SUSY with fermion number conservation is suggestive when the momentum directions of particle and  $\nu_R$  are completely correlated.
3. Since right-handed neutrino has no standard model couplings, p-adic thermodynamics for 4-D right-handed neutrino must correspond to a very low p-adic temperature  $T = 1/n$ . This implies that the excitations with non-vanishing conformal weights are effectively absent and one would have  $\mathcal{N} = 1$  SUSY effectively.

The simplest assumption is that particle and sparticle correspond to the same p-adic mass scale and have degenerate masses: it is difficult to imagine any good reason for why the p-adic mass scales should differ. This should have been observed -say in decay widths of weak bosons - unless the spartners correspond to large  $\hbar$  phase and therefore to dark matter. Note that for the badly broken 2-D  $\mathcal{N}=2$  SUSY in fermionic sector this kind of almost degeneracy cannot be excluded and I have considered an explanation for the mysterious X and Y mesons in terms of this degeneracy [K43].

### Why space-time SUSY is not possible in TGD framework?

LHC suggests that one does not have  $\mathcal{N} = 1$  SUSY in standard sense. Why one cannot have standard space-time SUSY in TGD framework. Let us begin by listing all arguments popping in mind.

1. Could covariantly constant  $\nu_R$  represents a gauge degree of freedom? This is plausible since the corresponding fermion current is non-vanishing.
2. The original argument for absence of space-time SUSY years ago was indirect:  $M^4 \times CP_2$  does not allow Majorana spinors so that  $\mathcal{N} = 1$  SUSY is excluded.
3. One can however consider  $\mathcal{N} = 2$  SUSY by including both helicities possible for covariantly constant  $\nu_R$ . For  $\nu_R$  the four-momentum vanishes so that one cannot distinguish the modes assigned to the creation operator and its conjugate via complex conjugation of the spinor. Rather, one oscillator operator and its conjugate correspond to the two different helicities of right-handed neutrino with respect to the direction determined by the momentum of the particle. The spinors can be chosen to be real in this basis. This indeed gives rise to an irreducible representation of spin 1/2 SUSY algebra with right-handed neutrino creation operator acting as a ladder operator. This is however  $\mathcal{N} = 1$  algebra and right-handed neutrino in this particular basis behaves effectively like Majorana spinor. One can argue that the system is mathematically inconsistent. By choosing the spin projection axis differently the spinor basis becomes complex. In the new basis one would have  $\mathcal{N} = 2$ , which however reduces to  $\mathcal{N} = 1$  in the real basis.
4. Or could it be that fermion and sfermion do exist but cannot be related by SUSY? In standard SUSY fermions and sfermions forming irreducible representations of super Poincare algebra are combined to components of superfield very much like finite-dimensional representations of Lorentz group are combined to those of Poincare. In TGD framework  $\nu_R$  generates in space-time interior generalization of 2-D super-conformal symmetry but covariantly constant  $\nu_R$  cannot give rise to space-time SUSY.

This would be very natural since right-handed neutrinos do not have any electroweak interactions and are delocalized into the interior of the space-time surface unlike other particles localized at 2-surfaces. It is difficult to imagine how fermion and  $\nu_R$  could behave as a single coherent unit reflecting itself in the characteristic spin and momentum dependence of vertices implied by SUSY. Rather, it would seem that fermion and sfermion should behave identically with respect to electroweak interactions.

The third argument looks rather convincing and can be developed to a precise argument.

1. If sfermion is to represent elementary bosons, the products of fermionic oscillator operators with the oscillator operators assignable to the covariantly constant right handed neutrinos must define might-be bosonic oscillator operators as  $b_n = a_n a$  and  $b_n^\dagger = a_n^\dagger a^\dagger$ . One can calculate the commutator for the product of operators. If fermionic oscillator operators commute, so do the corresponding bosonic operators. The commutator  $[b_n, b_n^\dagger]$  is however proportional to occupation number for  $\nu_R$  in  $\mathcal{N} = 1$  SUSY representation and vanishes for the second state of the representation. Therefore  $\mathcal{N} = 1$  SUSY is a pure gauge symmetry.
2. One can however have both irreducible representations of SUSY: for them either fermion or sfermion has a non-vanishing norm. One would have both fermions and sfermions but they would not belong to the same SUSY multiplet, and one cannot expect SUSY symmetries of 3-particle vertices.
3. For instance,  $\gamma FF$  vertex is closely related to  $\gamma \tilde{F} \tilde{F}$  in standard SUSY. Now one expects this vertex to decompose to a product of  $\gamma F \tilde{F}$  vertex and amplitude for the creation of  $\nu_R \tilde{\nu}_R$  from vacuum so that the characteristic momentum and spin dependent factors distinguishing between the couplings of photon to scalar and fermion are absent. Both states behave like fermions. The amplitude for the creation of  $\nu_R \tilde{\nu}_R$  from vacuum is naturally equal to unity as an occupation number operator by crossing symmetry. The presence of right-handed neutrinos would be invisible if this picture is correct. Whether this invisible label can have some consequences is not quite clear: one could argue that the decay rates of weak bosons to fermion pairs are doubled unless one introduces  $1/\sqrt{2}$  factors to couplings.

Where the sfermions might make themselves visible are loops. What loops are? Consider boson line first. Boson line is replaced with a sum of two contributions corresponding to ordinary contribution with fermion and antifermion at opposite throats and second contribution with fermion and antifermion accompanied by right-handed neutrino  $\nu_R$  and its antiparticle which now has opposite helicity to  $\nu_R$ . The loop for  $\nu_R$  decomposes to four pieces since also the propagation from wormhole throat to the opposite wormhole throat must be taken into account. Each of the four propagators equals to  $a_{1/2}^\dagger a_{-1/2}^\dagger$  or its hermitian conjugate. The product of these is slashed between vacuum states and anti-commutations give imaginary unit per propagator giving  $i^4 = 1$ . The two contributions are therefore identical and the scaling  $g \rightarrow g/\sqrt{2}$  for coupling constants guarantees that sfermions do not affect the scattering amplitudes at all. The argument is identical for the internal fermion lines.

### 3.4.3 WCW geometry and super-conformal symmetries

The vision about the geometry of WCW has been roughly the following and the recent steps of progress induce to it only small modifications if any.

1. Kähler geometry is forced by the condition that hermitian conjugation allows geometrization. Kähler function is given by the Kähler action coming from space-time regions with Euclidian signature of the induced metric identifiable as lines of generalized Feynman diagrams. Minkowskian regions give imaginary contribution identifiable as the analog of Morse function and implying interference effects and stationary phase approximation. The vision about quantum TGD as almost topological QFT inspires the proposal that Kähler action reduces to 3-D terms reducing to Chern-Simons terms by the weak form of electric-magnetic duality. The recent proposal for preferred extremals is consistent with this property realizing also holography implied by general coordinate invariance. Strong form of general coordinate invariance implying effective 2-dimensionality in turn suggests that Kähler action is expressible in terms of areas of partonic 2-surfaces and string world sheets.
2. The complexified gamma matrices of WCW come as hermitian conjugate pairs and anti-commute to the Kähler metric of WCW. Also bosonic generators of symplectic transformations of  $\delta M_\pm^4 \times CP_2$  assumed to act as isometries of WCW geometry can be complexified and appear as similar pairs. The action of isometry generators co-incides with that of symplectic generators at partonic 2-surfaces and string world sheets but elsewhere inside the space-time surface it is expected to be deformed from the symplectic action. The super-conformal transformations of

$\delta M_{\pm}^4 \times CP_2$  acting on the light-like radial coordinate of  $\delta M_{\pm}^4$  act as gauge symmetries of the geometry meaning that the corresponding WCW vector fields have zero norm.

3. WCW geometry has also zero modes which by definition do not contribute to WCW metric expect possibly by the dependence of the elements of WCW metric on zero modes through a conformal factor. In particular, induced  $CP_2$  Kähler form and its analog for sphere  $r_M = \text{constant}$  of light cone boundary are symplectic invariants, and one can define an infinite number of zero modes as invariants defined by Kähler fluxes over partonic 2-surfaces and string world sheets. This requires however the slicing of  $CD$  parallel copies of  $\delta M_{\pm}^4$  or  $\delta M_{\pm}^4$ . The physical interpretation of these non-quantum fluctuating degrees of freedom is as classical variables necessary for the interpretation of quantum measurement theory. Classical variable would metaphorically correspond the position of the pointer of the measurement instrument.
4. The construction receives a strong philosophical inspiration from the geometry of loop spaces. Loop spaces allow a unique Kähler geometry with maximal isometry group identifiable as Kac-Moody group. The reason is that otherwise Riemann connection does not exist. The only problem is that curvature scalar diverges since the Riemann tensor is by constant curvature property proportional to the metric. In 3-D case one would have union of constant curvature spaces labelled by zero modes and the situation is expected to be even more restrictive. The conjecture indeed is that WCW geometry exists only for  $H = M^4 \times CP_2$ : infinite-D Kähler geometric existence and therefore physics would be unique. One can also hope that Ricci scalar is finite and therefore zero by the constant curvature property so that Einstein's equations are satisfied.
5. WCW Hamiltonians determined the isometry currents and WCW metric is given in terms of the anti-commutators of the Killing vector fields associated with symplectic isometry currents. The WCW Hamiltonians generating symplectic isometries correspond to the Hamiltonians spanning the symplectic group of  $\delta M_{\pm}^4 \times CP_2$ . One can say that the space of quantum fluctuating degrees of freedom is this symplectic group of  $\delta M_{\pm}^4 \times CP_2$  or its subgroup or coset space: this must have very deep implications for the structure of the quantum TGD.
6. Zero energy ontology brings in additional delicacies. Basic objects are now unions of partonic 2-surfaces at the ends of  $CD$ . Also string world sheets would naturally contribute. One can generalize the expressions for the isometry generators in a straightforward manner by requiring that given isometry restricts to a symplectic transformation at partonic 2-surfaces and string world sheets.
7. One could criticize the effective metric 2-dimensionality forced by general consistency arguments as something non-physical. The Hamiltonians are expressed using only the data at partonic 2-surfaces: this includes also 4-D tangent space data via the weak form of electric-magnetic duality so that one has only effective 2-dimensionality. Obviously WCW geometry must have large gauge symmetries besides zero modes. The super-conformal symmetries indeed represent gauge symmetries of this kind. Effective 2-dimensionality realizing strong form of holography in turn is induced by the strong form of general coordinate invariance. Light-like 3-surfaces at which the signature of the induced metric changes must be equivalent with the 3-D space-like ends of space-time surfaces at the light-boundaries of space-time surfaces as far as WCW geometry is considered. This requires that the data from their 2-D intersections defining partonic 2-surfaces should dictate the WCW geometry. Note however that Super-Kac-Moody charges giving information about the interiors of 3-surfaces appear in the construction of the physical states.

What is the role of the right handed neutrino in this construction?

1. In the construction of components of WCW metric as anti-commutators of super-generators only the covariantly constant right-handed neutrino appears in the super-generators analogous to super-Kac-Moody generators. All holomorphic modes of right handed neutrino characterized by two integers could in principle contribute to the WCW gamma matrices identified as fermionic super-symplectic generators anti-commuting to the metric. At the space-like ends of space-time surface the holomorphic generators would restrict to symplectic generators since the radial



light-like coordinate  $r_M$  identified and complex coordinate of  $CP_2$  allowing identification as restrictions of two complex coordinates or Hamilton-Jacobi coordinates to light-like boundary.

2. The non-covariantly constant modes could also correspond to purely super-conformal gauge degrees of freedom. Originally the restriction to right-handed neutrino looked somewhat unsatisfactory but the recent view about Super-Kac-Moody symmetries makes its special role rather natural. One could say that WCW geometry possesses the maximal  $D = 4$  supersymmetry.
3. One can of course ask whether the Super-Kac-Moody generators assignable to the isometries of  $H$  and expressible as conserved charges associated with the boundaries of string world sheets could contribute to the WCW geometry via the anti-commutators. This option cannot be excluded but in this case the interpretation in terms of Hamiltonians is not obvious.

### 3.4.4 Equivalence Principle

An important physical input has been the condition that a generalization of Equivalence Principle is obtained.

1. The proposal has been that inertial and gravitational masses can be assigned with the super-symplectic and super-Kac-Moody representations via the condition that the scaling generator  $L_0$  defined as a difference of the corresponding generators for the two representations annihilates physical states. This requires that super-Kac-Moody algebra can be regarded in some sense as a sub-algebra of super-symplectic algebra. For isometries this would be natural but in the case of holonomies the situation is problematic. The idea has been that the ordinary realization of Equivalence Principle follows as Einstein's equations for fluctuations around vacuum extremals expressing the average energy momentum tensor for the fluctuations.
2. The emergence of Einstein's equations for preferred extremals as additional conditions [K9, K77] allowing the algebraization of the equations to analogs of minimal surface equations changes the situation completely. Is there anymore need to realize Equivalence Principle at quantum level? If one drops this condition one can imagine very simple option obtained as tensor product of the super-symplectic and super-Kac-Moody representations. Of course, coset representations for the symplectic group and its suitable subgroup - say subgroup defining measurement resolution - can be present but would not nothing to do with Equivalence Principle.
3. One can of course argue that one has very naturally to different mass squared operators and therefore inertial and gravitational masses. Inertial mass squared would be naturally assignable to the representations of the super-symplectic algebra imbedding space d'Alembertian and gravitational mass squared with the spinor d'Alembertian at string world sheets at space-time surfaces. Quantum level realization for Equivalence Principle could mean that these two mass squared operators are identical or something analogous to this. One can however criticize this idea as un-necessary and also because the signature of the effective metric defined by the modified Dirac gamma matrices is speculated to be Euclidian.

### 3.4.5 Constraints from p-adic mass calculations and ZEO

A further important physical input comes from p-adic thermodynamics forming a core element of p-adic mass calculations.

1. The first thing that one can get worried about relates to the extension of conformal symmetries. If the conformal symmetries generalize to  $D = 4$ , how can one take seriously the results of p-adic mass calculations based on 2-D conformal invariance? There is no reason to worry. The reduction of the conformal invariance to 2-D one for the preferred extremals takes care of this problem. This however requires that the fermionic contributions assignable to string world sheets and/or partonic 2-surfaces - Super- Kac-Moody contributions - should dictate the elementary particle masses. For hadrons also symplectic contributions should be present. This is a valuable hint in attempts to identify the mathematical structure in more detail.

2. ZEO suggests that all particles, even virtual ones correspond to massless wormhole throats carrying fermions. As a consequence, twistor approach would work and the kinematical constraints to vertices would allow the cancellation of divergences. This would suggest that the p-adic thermal expectation value is for the longitudinal  $M^2$  momentum squared (the definition of  $CD$  selects  $M^1 \subset M^2 \subset M^4$  as also does number theoretic vision). Also propagator would be determined by  $M^2$  momentum. Lorentz invariance would be obtained by integration of the moduli for  $CD$  including also Lorentz boosts of  $CD$ .
3. In the original approach one allows states with arbitrary large values of  $L_0$  as physical states. Usually one would require that  $L_0$  annihilates the states. In the calculations however mass squared was assumed to be proportional  $L_0$  apart from vacuum contribution. This is a questionable assumption. ZEO suggests that total mass squared vanishes and that one can decompose mass squared to a sum of longitudinal and transversal parts. If one can do the same decomposition to longitudinal and transverse parts also for the Super Virasoro algebra then one can calculate longitudinal mass squared as a p-adic thermal expectation in the transversal super-Virasoro algebra and only states with  $L_0 = 0$  would contribute and one would have conformal invariance in the standard sense.
4. In the original approach the assumption motivated by Lorentz invariance has been that mass squared is replaced with conformal weight in thermodynamics, and that one first calculates the thermal average of the conformal weight and then equates it with mass squared. This assumption is somewhat ad hoc. ZEO however suggests an alternative interpretation in which one has zero energy states for which longitudinal mass squared of positive energy state derive from p-adic thermodynamics. Thermodynamics - or rather, its square root - would become part of quantum theory in ZEO.  $M$ -matrix is indeed product of hermitian square root of density matrix multiplied by unitary  $S$ -matrix and defines the entanglement coefficients between positive and negative energy parts of zero energy state.
5. The crucial constraint is that the number of super-conformal tensor factors is  $N = 5$ : this suggests that thermodynamics applied in Super-Kac-Moody degrees of freedom assignable to string world sheets is enough, when one is interested in the masses of fermions and gauge bosons. Super-symplectic degrees of freedom can also contribute and determine the dominant contribution to baryon masses. Should also this contribution obey p-adic thermodynamics in the case when it is present? Or does the very fact that this contribution need not be present mean that it is not thermal? The symplectic contribution should correspond to hadronic p-adic length prime rather the one assignable to (say ) u quark. Hadronic p-adic mass squared and partonic p-adic mass squared cannot be summed since primes are different. If one accepts the basic rules [K46], longitudinal energy and momentum are additive as indeed assumed in perturbative QCD.
6. Calculations work if the vacuum expectation value of the mass squared must be assumed to be tachyonic. There are two options depending on whether one whether p-adic thermodynamics gives total mass squared or longitudinal mass squared.
  - (a) One could argue that the total mass squared has naturally tachyonic ground state expectation since for massless extremals longitudinal momentum is light-like and transversal momentum squared is necessarily present and non-vanishing by the localization to topological light ray of finite thickness of order p-adic length scale. Transversal degrees of freedom would be modeled with a particle in a box.
  - (b) If longitudinal mass squared is what is calculated, the condition would require that transversal momentum squared is negative so that instead of plane wave like behavior exponential damping would be required. This would conform with the localization in transversal degrees of freedom.
7. What about Equivalence Principle in this framework? A possible quantum counterpart of Equivalence Principle could be that the longitudinal parts of the imbedding space mass squared operator for a given massless state equals to that for d'Alembert operator assignable to the modified Dirac action. The attempts to formulate this in more precise manner however seem to produce only additional troubles.

### 3.4.6 The emergence of Yangian symmetry and gauge potentials as duals of Kac-Moody currents

Yangian symmetry plays a key role in  $\mathcal{N} = 4$  super-symmetric gauge theories. What is special in Yangian symmetry is that the algebra contains also multi-local generators. In TGD framework multi-locality would naturally correspond to that with respect to partonic 2-surfaces and string world sheets and the proposal has been that the Super-Kac-Moody algebras assignable to string worlds sheets could generalize to Yangian.

Witten has written a beautiful exposition of Yangian algebras [?]. Yangian is generated by two kinds of generators  $J^A$  and  $Q^A$  by a repeated formation of commutators. The number of commutations tells the integer characterizing the multi-locality and provides the Yangian algebra with grading by natural numbers. Witten describes a 2-dimensional QFT like situation in which one has 2-D situation and Kac-Moody currents assignable to real axis define the Kac-Moody charges as integrals in the usual manner. It is also assumed that the gauge potentials defined by the 1-form associated with the Kac-Moody current define a flat connection:

$$\partial_\mu j_\nu^A - \partial_\nu j_\mu^A + [j_\mu^A, j_\nu^A] = 0 . \tag{3.4.1}$$

This condition guarantees that the generators of Yangian are conserved charges. One can however consider alternative manners to obtain the conservation.

1. The generators of first kind - call them  $J^A$  - are just the conserved Kac-Moody charges. The formula is given by

$$J_A = \int_{-\infty}^{\infty} dx j^{A0}(x, t) . \tag{3.4.2}$$

2. The generators of second kind contain bi-local part. They are convolutions of generators of first kind associated with different points of string described as real axis. In the basic formula one has integration over the point of real axis.

$$Q^A = f_{BC}^A \int_{-\infty}^{\infty} dx \int_x^{\infty} dy j^{B0}(x, t) j^{C0}(y, t) - 2 \int_{-\infty}^{\infty} j_x^A dx . \tag{3.4.3}$$

These charges are indeed conserved if the curvature form is vanishing as a little calculation shows.

How to generalize this to the recent context?

1. The Kac-Moody charges would be associated with the braid strands connecting two partonic 2-surfaces - Strands would be located either at the space-like 3-surfaces at the ends of the space-time surface or at light-like 3-surfaces connecting the ends. Modified Dirac equation would define Super-Kac-Moody charges as standard Noether charges. Super charges would be obtained by replacing the second quantized spinor field or its conjugate in the fermionic bilinear by particular mode of the spinor field. By replacing both spinor field and its conjugate by its mode one would obtain a conserved c-number charge corresponding to an anti-commutator of two fermionic super-charges. The convolution involving double integral is however not number theoretically attractive whereas single 1-D integrals might make sense.
2. An encouraging observation is that the Hodge dual of the Kac-Moody current defines the analog of gauge potential and exponents of the conserved Kac-Moody charges could be identified as analogs for the non-integrable phase factors for the components of this gauge potential. This identification is precise only in the approximation that generators commute since only in this case the ordered integral  $P(\exp(i \int Adx))$  reduces to  $P(\exp(i \int Adx))$ . Partonic 2-surfaces connected

by braid strand would be analogous to nearby points of space-time in its discretization implying that Abelian approximation works. This conforms with the vision about finite measurement resolution as discretization in terms partonic 2-surfaces and braids.

This would make possible a direct identification of Kac-Moody symmetries in terms of gauge symmetries. For isometries one would obtain color gauge potentials and the analogs of gauge potentials for graviton field (in TGD framework the contraction with  $M^4$  vierbein would transform tensor field to 4 vector fields). For Kac-Moody generators corresponding to holonomies one would obtain electroweak gauge potentials. Note that super-charges would give rise to a collection of spartners of gauge potentials automatically. One would obtain a badly broken SUSY with very large value of  $\mathcal{N}$  defined by the number of spinor modes as indeed speculated earlier [?].

3. The condition that the gauge field defined by 1-forms associated with the Kac-Moody currents are trivial looks unphysical since it would give rise to the analog of topological QFT with gauge potentials defined by the Kac-Moody charges. For the duals of Kac-Moody currents defining gauge potentials only covariant divergence vanishes implying that curvature form is

$$F_{\alpha\beta} = \epsilon_{\alpha\beta} [j_\mu, j^\mu] , \quad (3.4.4)$$

so that the situation does not reduce to topological QFT unless the induced metric is diagonal. This is not the case in general for string world sheets.

4. It seems however that there is no need to assume that  $j_\mu$  defines a flat connection. Witten mentions that although the discretization in the definition of  $J^A$  does not seem to be possible, it makes sense for  $Q^A$  in the case of  $G = SU(N)$  for any representation of  $G$ . For general  $G$  and its general representation there exists no satisfactory definition of  $Q$ . For certain representations, such as the fundamental representation of  $SU(N)$ , the definition of  $Q^A$  is especially simple. One just takes the bi-local part of the previous formula:

$$Q^A = f_{BC}^A \sum_{i < j} J_i^B J_j^C . \quad (3.4.5)$$

What is remarkable that in this formula the summation need not refer to a discretized point of braid but to braid strands ordered by the label  $i$  by requiring that they form a connected polygon. Therefore the definition of  $J^A$  could be just as above.

5. This brings strongly in mind the interpretation in terms of twistor diagrams. Yangian would be identified as the algebra generated by the logarithms of non-integrable phase factors in Abelian approximation assigned with pairs of partonic 2-surfaces defined in terms of Kac-Moody currents assigned with the modified Dirac action. Partonic 2-surfaces connected by braid strand would be analogous to nearby points of space-time in its discretization. This would fit nicely with the vision about finite measurement resolution as discretization in terms partonic 2-surfaces and braids.

The resulting algebra satisfies the basic commutation relations

$$[J^A, J^B] = f_C^{AB} J^C , \quad [J^A, Q^B] = f_C^{AB} Q^C . \quad (3.4.6)$$

plus the rather complex Serre relations described in [?].

### 3.4.7 Quantum criticality and electro-weak gauge symmetries

Quantum criticality is one of the basic guiding principles of Quantum TGD. What it means mathematically is however far from clear.

1. What is obvious is that quantum criticality implies quantization of Kähler coupling strength as a mathematical analog of critical temperature so that the theory becomes mathematically unique if only single critical temperature is possible. Physically this means the presence of long range fluctuations characteristic for criticality and perhaps assignable to the effective hierarchy of Planck constants having explanation in terms of effective covering spaces of the imbedding space. This hierarchy follows from the vacuum degeneracy of Kähler action, which in turn implies 4-D spin-glass degeneracy. It is easy to interpret the degeneracy in terms of criticality.
2. At more technical level one would expect criticality to correspond deformations of a given preferred extremal defining a vanishing second variation of Kähler action. This is analogous to the vanishing of also second derivatives of potential function at extremum in certain directions so that the matrix defined by second derivatives does not have maximum rank. Entire hierarchy of criticalities is expected and a good finite-dimensional model is provided by the catastrophe theory of Thom [A16]. Cusp catastrophe [?] is the simplest catastrophe one can think of, and here the folds of cusp where discontinuous jump occurs correspond to criticality with respect to one control variable and the tip to criticality with respect to both control variables.
3. I have discussed what criticality could mean for modified Dirac action [?] and claimed that it leads to the existence of additional conserved currents defined by the variations which do not affect the value of Kähler action. These arguments are far from being mathematically rigorous and the recent view about the solutions of the modified Dirac equation predicting that the spinor modes are restricted to 2-D string world sheets requires a modification of these arguments.

In the following these arguments are updated. The unexpected result is that critical deformations induce conformal scalings of the modified metric and electro-weak gauge transformations of the induced spinor connection at  $X^2$ . Therefore holomorphy brings in the Kac-Moody symmetries associated with isometries of  $H$  (gravitation and color gauge group) and quantum criticality those associated with the holonomies of  $H$  (electro-weak-gauge group) as additional symmetries.

#### The variation of modes of the induced spinor field in a variation of space-time surface respecting the preferred extremal property

Consider first the variation of the induced spinor field in a variation of space-time surface respecting the preferred extremal property. The deformation must be such that the deformed modified Dirac operator  $D$  annihilates the modified mode. By writing explicitly the variation of the modified Dirac action (the action vanishes by modified Dirac equation) one obtains deformations and requiring its vanishing one obtains

$$\delta\Psi = D^{-1}(\delta D)\Psi . \tag{3.4.7}$$

$D^{-1}$  is the inverse of the modified Dirac operator defining the analog of Dirac propagator and  $\delta D$  defines vertex completely analogous to  $\gamma^k \delta A_k$  in gauge theory context. The functional integral over preferred extremals can be carried out perturbatively by expressing  $\delta D$  in terms of  $\delta h^k$  and one obtains stringy perturbation theory around  $X^2$  associated with the preferred extremal defining maximum of Kähler function in Euclidian region and extremum of Kähler action in Minkowskian region (stationary phase approximation).

What one obtains is stringy perturbation theory for calculating n-points functions for fermions at the ends of braid strands located at partonic 2-surfaces and representing intersections of string world sheets and partonic 2-surfaces at the light-like boundaries of  $CD$ s.  $\delta D$ - or more precisely, its partial derivatives with respect to functional integration variables - appear at the vertices located anywhere in the interior of  $X^2$  with outgoing fermions at braid ends. Bosonic propagators are replaced with correlation functions for  $\delta h^k$ . Fermionic propagator is defined by  $D^{-1}$ .

After 35 years or hard work this provides for the first time a reasonably explicit formula for the N-point functions of fermions. This is enough since by bosonic emergence [?] these N-point functions

define the basic building blocks of the scattering amplitudes. Note that bosonic emergence states that bosons corresponds to wormhole contacts with fermion and antifermion at the opposite wormhole throats.

### What critical modes could mean for the induced spinor fields?

What critical modes could mean for the induced spinor fields at string world sheets and partonic 2-surfaces. The problematic part seems to be the variation of the modified Dirac operator since it involves gradient. One cannot require that covariant derivative remains invariant since this would require that the components of the induced spinor connection remain invariant and this is quite too restrictive condition. Right handed neutrino solutions delocalized into entire  $X^2$  are however an exception since they have no electro-weak gauge couplings and in this case the condition is obvious: modified gamma matrices suffer a local scaling for critical deformations:

$$\delta\Gamma^\mu = \Lambda(x)\Gamma^\mu . \quad (3.4.8)$$

This guarantees that the modified Dirac operator  $D$  is mapped to  $\Lambda D$  and still annihilates the modes of  $\nu_R$  labelled by conformal weight, which thus remain unchanged.

What is the situation for the 2-D modes located at string world sheets? The condition is obvious.  $\Psi$  suffers an electro-weak gauge transformation as does also the induced spinor connection so that  $D_\mu$  is not affected at all. Criticality condition states that the deformation of the space-time surfaces induces a conformal scaling of  $\Gamma^\mu$  at  $X^2$ . It might be possible to continue this conformal scaling of the entire space-time sheet but this might be not necessary and this would mean that all critical deformations induced conformal transformations of the effective metric of the space-time surface defined by  $\{\Gamma^\mu, \Gamma^\nu\} = 2G^{\mu\nu}$ . Thus it seems that effective metric is indeed central concept (recall that if the conjectured quaternionic structure is associated with the effective metric, it might be possible to avoid problem related to the Minkowskian signature in an elegant manner).

In fact, one can consider even more general action of critical deformation: the modes of the induced spinor field would be mixed together in the infinitesimal deformation besides infinitesimal electroweak gauge transformation, which is same for all modes. This would extend electroweak gauge symmetry. Modified Dirac equation holds true also for these deformations. One might wonder whether the conjectured dynamically generated gauge symmetries assignable to finite measurement resolution could be generated in this manner.

The infinitesimal generator of a critical deformation  $J_M$  can be expressed as tensor product of matrix  $A_M$  acting in the space of zero modes and of a generator of infinitesimal electro-weak gauge transformation  $T_M(x)$  acting in the same manner on all modes:  $J_M = A_M \otimes T_M(x)$ .  $A_M$  is a spatially constant matrix and  $T_M(x)$  decomposes to a direct sum of left- and right-handed  $SU(2) \times U(1)$  Lie-algebra generators. Left-handed Lie-algebra generator can be regarded as a quaternion and right handed as a complex number. One can speak of a direct sum of left-handed local quaternion  $q_{M,L}$  and right-handed local complex number  $c_{M,R}$ . The commutator  $[J_M, J_N]$  is given by  $[J_M, J_N] = [A_M, A_N] \otimes \{T_M(x), T_N(x)\} + \{A_M, A_N\} \otimes [T_M(x), T_N(x)]$ . One has  $\{T_M(x), T_N(x)\} = \{q_{M,L}(x), q_{N,L}(x)\} \oplus \{c_{M,R}(x), c_{N,R}(x)\}$  and  $[T_M(x), T_N(x)] = [q_{M,L}(x), q_{N,L}(x)]$ . The commutators make sense also for more general gauge group but quaternion/complex number property might have some deeper role.

Thus the critical deformations would induce conformal scalings of the effective metric and dynamical electro-weak gauge transformations. Electro-weak gauge symmetry would be a dynamical symmetry restricted to string world sheets and partonic 2-surfaces rather than acting at the entire space-time surface. For 4-D delocalized right-handed neutrino modes the conformal scalings of the effective metric are analogous to the conformal transformations of  $M^4$  for  $\mathcal{N} = 4$  SYMs. Also ordinary conformal symmetries of  $M^4$  could be present for string world sheets and could act as symmetries of generalized Feynman graphs since even virtual wormhole throats are massless. An interesting question is whether the conformal invariance associated with the effective metric is the analog of dual conformal invariance in  $\mathcal{N} = 4$  theories.

Critical deformations of space-time surface are accompanied by conserved fermionic currents. By using standard Noetherian formulas one can write

$$J_i^\mu = \bar{\Psi}\Gamma^\mu\delta_i\Psi + \delta_i\bar{\Psi}\Gamma^\mu\Psi . \quad (3.4.9)$$

Here  $\delta\Psi_i$  denotes derivative of the variation with respect to a group parameter labeled by  $i$ . Since  $\delta\Psi_i$  reduces to an infinitesimal gauge transformation of  $\Psi$  induced by deformation, these currents are the analogs of gauge currents. The integrals of these currents along the braid strands at the ends of string world sheets define the analogs of gauge charges. The interpretation as Kac-Moody charges is also very attractive and I have proposed that the 2-D Hodge duals of gauge potentials could be identified as Kac-Moody currents. If so, the 2-D Hodge duals of  $J$  would define the quantum analogs of dynamical electro-weak gauge fields and Kac-Moody charge could be also seen as non-integral phase factor associated with the braid strand in Abelian approximation (the interpretation in terms of finite measurement resolution is discussed earlier).

One can also define super currents by replacing  $\bar{\Psi}$  or  $\Psi$  by a particular mode of the induced spinor field as well as c-number valued currents by performing the replacement for both  $\bar{\Psi}$  or  $\Psi$ . As expected, one obtains a super-conformal algebra with all modes of induced spinor fields acting as generators of super-symmetries restricted to 2-D surfaces. The number of the charges which do not annihilate physical states as also the effective number of fermionic modes could be finite and this would suggest that the integer  $\mathcal{N}$  for the supersymmetry in question is finite. This would conform with the earlier proposal inspired by the notion of finite measurement resolution implying the replacement of the partonic 2-surfaces with collections of braid ends.

Note that Kac-Moody charges might be associated with "long" braid strands connecting different wormhole throats as well as short braid strands connecting opposite throats of wormhole contacts. Both kinds of charges would appear in the theory.

#### What is the interpretation of the critical deformations?

Critical deformations bring in an additional gauge symmetry. Certainly not all possible gauge transformations are induced by the deformations of preferred extremals and a good guess is that they correspond to holomorphic gauge group elements as in theories with Kac-Moody symmetry. What is the physical character of this dynamical gauge symmetry?

1. Do the gauge charges vanish? Do they annihilate the physical states? Do only their positive energy parts annihilate the states so that one has a situation characteristic for the representation of Kac-Moody algebras. Or could some of these charges be analogous to the gauge charges associated with the constant gauge transformations in gauge theories and be therefore non-vanishing in the absence of confinement. Now one has electro-weak gauge charges and these should be non-vanishing. Can one assign them to deformations with a vanishing conformal weight and the remaining deformations to those with non-vanishing conformal weight and acting like Kac-Moody generators on the physical states?
2. The simplest option is that the critical Kac-Moody charges/gauge charges with non-vanishing positive conformal weight annihilate the physical states. Critical degrees of freedom would not disappear but make their presence known via the states labelled by different gauge charges assignable to critical deformations with vanishing conformal weight. Note that constant gauge transformations can be said to break the gauge symmetry also in the ordinary gauge theories unless one has confinement.
3. The hierarchy of quantum criticalities suggests however entire hierarchy of electro-weak Kac-Moody algebras. Does this mean a hierarchy of electro-weak symmetries breakings in which the number of Kac-Moody generators not annihilating the physical states gradually increases as also modes with a higher value of positive conformal weight fail to annihilate the physical state?

The only manner to have a hierarchy of algebras is by assuming that only the generators satisfying  $n \bmod N = 0$  define the sub-Kac-Moody algebra annihilating the physical states so that the generators with  $n \bmod N \neq 0$  would define the analogs of gauge charges. I have suggested for long time ago the relevance of kind of fractal hierarchy of Kac-Moody and Super-Virasoro algebras for TGD but failed to imagine any concrete realization.

A stronger condition would be that the algebra reduces to a finite dimensional algebra in the sense that the actions of generators  $Q_n$  and  $Q_{n+kN}$  are identical. This would correspond to periodic boundary conditions in the space of conformal weights. The notion of finite measurement resolution suggests that the number of independent fermionic oscillator operators is proportional to the number of braid ends so that an effective reduction to a finite algebra is expected.

Whatever the correct interpretation is, this would obviously refine the usual view about electro-weak symmetry breaking.

These arguments suggests the following overall view. The holomorphy of spinor modes gives rise to Kac-Moody algebra defined by isometries and includes besides Minkowskian generators associated with gravitation also  $SU(3)$  generators associated with color symmetries. Vanishing second variations in turn define electro-weak Kac-Moody type algebra.

Note that criticality suggests that one must perform functional integral over WCW by decomposing it to an integral over zero modes for which deformations of  $X^4$  induce only an electro-weak gauge transformation of the induced spinor field and to an integral over moduli corresponding to the remaining degrees of freedom.

### 3.4.8 The importance of being light-like

The singular geometric objects associated with the space-time surface have become increasingly important in TGD framework. In particular, the recent progress has made clear that these objects might be crucial for the understanding of quantum TGD. The singular objects are associated not only with the induced metric but also with the effective metric defined by the anti-commutators of the modified gamma matrices appearing in the modified Dirac equation and determined by the Kähler action.

#### The singular objects associated with the induced metric

Consider first the singular objects associated with the induced metric.

1. At light-like 3-surfaces defined by wormhole throats the signature of the induced metric changes from Euclidian to Minkowskian so that 4-metric is degenerate. These surfaces are carriers of elementary particle quantum numbers and the 4-D induced metric degenerates locally to 3-D one at these surfaces.
2. Braid strands at light-like 3-surfaces are most naturally light-like curves: this correspond to the boundary condition for open strings. One can assign fermion number to the braid strands. Braid strands allow an identification as curves along which the Euclidian signature of the string world sheet in Euclidian region transforms to Minkowskian one. Number theoretic interpretation would be as a transformation of complex regions to hyper-complex regions meaning that imaginary unit  $i$  satisfying  $i^2 = -1$  becomes hyper-complex unit  $e$  satisfying  $e^2 = 1$ . The complex coordinates  $(z, \bar{z})$  become hyper-complex coordinates  $(u = t + ex, v = t - ex)$  giving the standard light-like coordinates when one puts  $e = 1$ .

#### The singular objects associated with the effective metric

There are also singular objects assignable to the effective metric. According to the simple arguments already developed, string world sheets and possibly also partonic 2-surfaces are singular objects with respect to the effective metric defined by the anti-commutators of the modified gamma matrices rather than induced gamma matrices. Therefore the effective metric seems to be much more than a mere formal structure.

1. For instance, quaternionicity of the space-time surface could allow an elegant formulation in terms of the effective metric avoiding the problems due to the Minkowski signature. This is achieved if the effective metric has Euclidian signature  $\epsilon \times (1, 1, 1, 1)$ ,  $\epsilon = \pm 1$  or a complex counterpart of the Minkowskian signature  $\epsilon(1, 1, -1, -1)$ .
2. String world sheets and perhaps also partonic 2-surfaces could be understood as singularities of the effective metric. What happens that the effective metric with Euclidian signature  $\epsilon \times (1, 1, 1, 1)$  transforms to the signature  $\epsilon(1, 1, -1, -1)$  (say) at string world sheet so that one would have the degenerate signature  $\epsilon \times (1, 1, 0, 0)$  at the string world sheet.

What is amazing is that this works also number theoretically. It came as a total surprise to me that the notion of hyper-quaternions as a closed algebraic structure indeed exists. The hyper-quaternionic units would be given by  $(1, I, iJ, iK)$ , where  $i$  is a commuting imaginary unit



satisfying  $i^2 = -1$ . Hyper-quaternionic numbers defined as combinations of these units with real coefficients do form a closed algebraic structure which however fails to be a number field just like hyper-complex numbers do. Note that the hyper-quaternions obtained with real coefficients from the basis  $(1, iI, iJ, iK)$  fail to form an algebra since the product is not hyper-quaternion in this sense but belongs to the algebra of complexified quaternions. The same problem is encountered in the case of hyper-octonions defined in this manner. This has been a stone in my shoe since I feel strong disrelish towards Wick rotation as a trick for moving between different signatures.

3. Could also partonic 2-surfaces correspond to this kind of singular 2-surfaces? In principle, 2-D surfaces of 4-D space intersect at discrete points just as string world sheets and partonic 2-surfaces do so that this might make sense. By complex structure the situation is algebraically equivalent to the analog of plane with non-flat metric allowing all possible signatures  $(\epsilon_1, \epsilon_2)$  in various regions. At light-like curve either  $\epsilon_1$  or  $\epsilon_2$  changes sign and light-like curves for these two kinds of changes can intersect as one can easily verify by drawing what happens. At the intersection point the metric is completely degenerate and simply vanishes.
4. Replacing real 2-dimensionality with complex 2-dimensionality, one obtains by the universality of algebraic dimension the same result for partonic 2-surfaces and string world sheets. The braid ends at partonic 2-surfaces representing the intersection points of 2-surfaces of this kind would have completely degenerate effective metric so that the modified gamma matrices would vanish implying that energy momentum tensor vanishes as does also the induced Kähler field.
5. The effective metric suffers a local conformal scaling in the critical deformations identified in the proposed manner. Since ordinary conformal group acts on Minkowski space and leaves the boundary of light-cone invariant, one has two conformal groups. It is not however clear whether the  $M^4$  conformal transformations can act as symmetries in TGD, where the presence of the induced metric in Kähler action breaks  $M^4$  conformal symmetry. As found, also in TGD framework the Kac-Moody currents assigned to the braid strands generate Yangian: this is expected to be true also for the Kac-Moody counterparts of the conformal algebra associated with quantum criticality. On the other hand, in twistor program one encounters also two conformal groups and the space in which the second conformal group acts remains somewhat mysterious object. The Lie algebras for the two conformal groups generate the conformal Yangian and the integrands of the scattering amplitudes are Yangian invariants. Twistor approach should apply in TGD if zero energy ontology is right. Does this mean a deep connection?

What is also intriguing that twistor approach in principle works in strict mathematical sense only at signatures  $\epsilon \times (1, 1, -1 - 1)$  and the scattering amplitudes in Minkowski signature are obtained by analytic continuation. Could the effective metric give rise to the desired signature? Note that the notion of massless particle does not make sense in the signature  $\epsilon \times (1, 1, 1, 1)$ .

These arguments provide genuine a support for the notion of quaternionicity and suggest a connection with the twistor approach.

### 3.4.9 Realization of large $\mathcal{N}$ SUSY in TGD

The generators large  $\mathcal{N}$  SUSY algebras are obtained by taking fermionic currents for second quantized fermions and replacing either fermion field or its conjugate with its particular mode. The resulting super currents are conserved and define super charges. By replacing both fermion and its conjugate with modes one obtains c number valued currents. Therefore  $\mathcal{N} = \infty$  SUSY - presumably equivalent with super-conformal invariance - or its finite  $\mathcal{N}$  cutoff is realized in TGD framework and the challenge is to understand the realization in more detail.

#### Super-space viz. Grassmann algebra valued fields

Standard SUSY induces super-space extending space-time by adding anti-commuting coordinates as a formal tool. Many mathematicians are not enthusiastic about this approach because of the purely formal nature of anti-commuting coordinates. Also I regard them as a non-sense geometrically and there is actually no need to introduce them as the following little argument shows.

Grassmann parameters (anti-commuting theta parameters) are generators of Grassmann algebra and the natural object replacing super-space is this Grassmann algebra with coefficients of Grassmann algebra basis appearing as ordinary real or complex coordinates. This is just an ordinary space with additional algebraic structure: the mysterious anti-commuting coordinates are not needed. To me this notion is one of the conceptual monsters created by the over-pragmatic thinking of theoreticians.

This allows to replace field space with super field space, which is completely well-defined object mathematically, and leave space-time untouched. Linear field space is simply replaced with its Grassmann algebra. For non-linear field space this replacement does not work. This allows to formulate the notion of linear super-field just in the same manner as it is done usually.

The generators of super-symmetries in super-space formulation reduce to super translations, which anti-commute to translations. The super generators  $Q_\alpha$  and  $\bar{Q}_{\dot{\beta}}$  of super Poincare algebra are Weyl spinors commuting with momenta and anti-commuting to momenta:

$$\{Q_\alpha, \bar{Q}_{\dot{\beta}}\} = 2\sigma_{\alpha\dot{\beta}}^\mu P_\mu . \quad (3.4.10)$$

One particular representation of super generators acting on super fields is given by

$$\begin{aligned} D_\alpha &= i \frac{\partial}{\partial \theta_\alpha} , \\ D_{\dot{\alpha}} &= i \frac{\partial}{\partial \bar{\theta}_{\dot{\alpha}}} + \theta^\beta \sigma_{\beta\dot{\alpha}}^\mu \partial_\mu \end{aligned} \quad (3.4.11)$$

Here the index raising for 2-spinors is carried out using antisymmetric 2-tensor  $\epsilon^{\alpha\beta}$ . Super-space interpretation is not necessary since one can interpret this action as an action on Grassmann algebra valued field mixing components with different fermion numbers.

Chiral superfields are defined as fields annihilated by  $D_{\dot{\alpha}}$ . Chiral fields are of form  $\Psi(x^\mu + i\bar{\theta}\sigma^\mu\theta, \theta)$ . The dependence on  $\bar{\theta}_{\dot{\alpha}}$  comes only from its presence in the translated Minkowski coordinate annihilated by  $D_{\dot{\alpha}}$ . Super-space enthusiast would say that by a translation of  $M^4$  coordinates chiral fields reduce to fields, which depend on  $\theta$  only.

### The space of fermionic Fock states at partonic 2-surface as TGD counterpart of chiral super field

As already noticed, another manner to realize SUSY in terms of representations the super algebra of conserved super-charges. In TGD framework these super charges are naturally associated with the modified Dirac equation, and anti-commuting coordinates and super-fields do not appear anywhere. One can however ask whether one could identify a mathematical structure replacing the notion of chiral super field.

In [?] it was proposed that generalized chiral super-fields could effectively replace induced spinor fields and that second quantized fermionic oscillator operators define the analog of SUSY algebra. One would have  $\mathcal{N} = \infty$  if all the conformal excitations of the induced spinor field restricted on 2-surface are present. For right-handed neutrino the modes are labeled by two integers and delocalized to the interior of Euclidian or Minkowskian regions of space-time sheet.

The obvious guess is that chiral super-field generalizes to the field having as its components many-fermions states at partonic 2-surfaces with theta parameters and their conjugates in one-one correspondence with fermionic creation operators and their hermitian conjugates.

1. Fermionic creation operators - in classical theory corresponding anti-commuting Grassmann parameters - replace theta parameters. Theta parameters and their conjugates are not in one-one correspondence with spinor components but with the fermionic creation operators and their hermitian conjugates. One can say that the super-field in question is defined in the "world of classical worlds" (WCW) rather than in space-time. Fermionic Fock state at the partonic 2-surface is the value of the chiral super field at particular point of WCW.
2. The matrix defined by the  $\sigma^\mu \partial_\mu$  is replaced with a matrix defined by the modified Dirac operator  $D$  between spinor modes acting in the solution space of the modified Dirac equation. Since modified Dirac operator annihilates the modes of the induced spinor field, super covariant derivatives

reduce to ordinary derivatives with respect the theta parameters labeling the modes. Hence the chiral super field is a field that depends on  $\theta_m$  or conjugates  $\bar{\theta}_m$  only. In second quantization the modes of the chiral super-field are many-fermion states assigned to partonic 2-surfaces and string world sheets. Note that this is the only possibility since the notion of super-coordinate does not make sense now.

3. It would seem that the notion of super-field does not bring anything new. This is not the case. First of all, the spinor fields are restricted to 2-surfaces. Second point is that one cannot assign to the fermions of the many-fermion states separate non-parallel or even parallel four-momenta. The many-fermion state behaves like elementary particle. This has non-trivial implications for propagators and a simple argument [?] leads to the proposal that propagator for N-fermion partonic state is proportional to  $1/p^N$ . This would mean that only the states with fermion number equal to 1 or 2 behave like ordinary elementary particles.

#### How the fermionic anti-commutation relations are determined?

Understanding the fermionic anti-commutation relations is not trivial since all fermion fields except right-handed neutrino are assumed to be localized at 2-surfaces. Since fermionic conserved currents must give rise to well-defined charges as 3-D integrals the spinor modes must be proportional to a square root of delta function in normal directions. Furthermore, the modified Dirac operator must act only in the directions tangential to the 2-surface in order that the modified Dirac equation can be satisfied.

The square root of delta function can be formally defined by starting from the expansion of delta function in discrete basis for a particle in 1-D box. The product of two functions in x-space is convolution of Fourier transforms and the coefficients of Fourier transform of delta function are apart from a constant multiplier equal to 1:  $\delta(x) = K \sum_n \exp(inx/2\pi L)$ . Therefore the Fourier transform of square root of delta function is obtained by normalizing the Fourier transform of delta function by  $1/\sqrt{N}$ , where  $N \rightarrow \infty$  is the number of plane waves. In other words:  $\sqrt{\delta(x)} = \sqrt{\frac{K}{N}} \sum_n \exp(inx/2\pi L)$ .

Canonical quantization defines the standard approach to the second quantization of the Dirac equation.

1. One restricts the consideration to time=constant slices of space-time surface. Now the 3-surfaces at the ends of  $CD$  are natural slices. The intersection of string world sheet with these surfaces is 1-D whereas partonic 2-surfaces have 2-D Euclidian intersection with them.
2. The canonical momentum density is defined by

$$\begin{aligned} \Pi_\alpha &= \frac{\partial L}{\partial_t \bar{\Psi}_\alpha(x)} = \Gamma^t \Psi \quad , \\ \Gamma^t &= \frac{\partial L_K}{\partial(\partial_t h^k)} \quad . \end{aligned} \tag{3.4.12}$$

$L_K$  denotes Kähler action density: consistency requires  $D_\mu \Gamma^\mu = 0$ , and this is guaranteed only by using the modified gamma matrices defined by Kähler action. Note that  $\Gamma^t$  contains also the  $\sqrt{g_4}$  factor. Induced gamma matrices would require action defined by four-volume.  $t$  is time coordinate varying in direction tangential to 2-surface.

3. The standard equal time canonical anti-commutation relations state

$$\{\Pi_\alpha, \bar{\Psi}_\beta\} = \delta^3(x, y) \delta_{\alpha\beta} \quad . \tag{3.4.13}$$

Can these conditions be applied both at string world sheets and partonic 2-surfaces.

1. String world sheets do not pose problems. The restriction of the modes to string world sheets means that the square root of delta function in the normal direction of string world sheet takes care of the normal dimensions and the dynamical part of anti-commutation relations is 1-dimensional just as in the case of strings.
2. Partonic 2-surfaces are problematic. The  $\sqrt{g_4}$  factor in  $\Gamma^t$  implies that  $\Gamma^t$  approaches zero at partonic 2-surfaces since they belong to light-like wormhole throats at which the signature of the induced metric changes. Energy momentum tensor appearing in  $\Gamma^t$  involves to index raisins by induced metric so that it can grow without limit as one approaches partonic two-surface. Therefore it is quite possible that the limit is finite and the boundary conditions defined by the weak form of electric magnetic duality might imply that the limit is finite. The open question is whether one can apply canonical quantization at partonic 2-surfaces. One can also ask whether one can define induced spinor fields at wormhole throats only at the ends of string world sheets so that partonic 2-surface would be effectively discretized. This cautious conclusion emerged in the earlier study of the modified Dirac equation [?].
3. Suppose that one can assume spinor modes at partonic 2-surfaces. 2-D conformal invariance suggests that the situation reduces to effectively one-dimensional also at the partonic two-surfaces. If so, one should pose the anti-commutation relations at some 1-D curves of the partonic 2-surface only. This is the only sensible option. The point is that the action of the modified Dirac operator is tangential so that also the canonical momentum current must be tangential and one can fix anti-commutations only at some set of curves of the partonic 2-surface.

One can of course worry what happens at the limit of vacuum extremals. The problem is that  $\Gamma^t$  vanishes for space-time surfaces reducing to vacuum extremals at the 2-surfaces carrying fermions so that the anti-commutations are inconsistent. Should one require - as done earlier- that the anti-commutation relations make sense at this limit and cannot therefore have the standard form but involve the scalar magnetic flux formed from the induced Kähler form by permuting it with the 2-D permutations symbol? The restriction to preferred extremals, which are always non-vacuum extremals, might allow to avoid this kind of problems automatically.

In the case of right-handed neutrino the situation is genuinely 3-dimensional and in this case non-vacuum extremal property must hold true in the regions where the modes of  $\nu_R$  are non-vanishing. The same mechanism would save from problems also at the partonic 2-surfaces. The dynamics of induced spinor fields must avoid classical vacuum. Could this relate to color confinement? Could hadrons be surrounded by an insulating layer of Kähler vacuum?

## 3.5 Twistor revolution and TGD

Lubos Motl wrote a nice summary about the talk of Nima Arkani Hamed about twistor revolution in Strings 2012 and gave also a link to the talk [?]. It seems that Nima and collaborators are ending to a picture about scattering amplitudes which strongly resembles that provided by generalized Feynman diagrammatics in TGD framework

TGD framework is much more general than  $\mathcal{N} = 4$  SYM and is to it same as general relativity for special relativity whereas the latter is completely explicit. Of course, I cannot hope that TGD view could be taken seriously - at least publicly. One might hope that these approaches could be combined some day: both have a lot to give for each other. Below I compare these approaches.

### 3.5.1 The origin of twistor diagrammatics

In TGD framework zero energy ontology forces to replace the idea about continuous unitary evolution in Minkowski space with something more general assignable to causal diamonds (CDs), and S-matrix is replaced with a square root of density matrix equal to a hermitian l square root of density matrix multiplied by unitary S-matrix. Also in twistor approach unitarity has ceased to be a star actor. In p-Adic context continuous unitary time evolution fails to make sense also mathematically.

Twistor diagrammatics involves only massless on mass shell particles on both external and internal lines. Zero energy ontology (ZEO) requires same in TGD: wormhole lines carry parallelly moving

massless fermions and antifermions. The mass shell conditions at vertices are enormously powerful and imply UV finiteness. Also IR finiteness follows if external particles are massive.

What one means with mass is however a delicate matter. What does one mean with mass? I have pondered 35 years this question and the recent view is inspired by p-adic mass calculations and ZEO, and states that observed mass is in a well-defined sense expectation value of longitudinal mass squared for all possible choices of  $M^2 \subset M^4$  characterizing the choices of quantization axis for energy and spin at the level of "world of classical worlds" (WCW) assignable with given causal diamond  $CD$ .

The choice of quantization axis thus becomes part of the geometry of WCW. All wormhole throats are massless but develop non-vanishing longitudinal mass squared. Gauge bosons correspond to wormhole contacts and thus consist of pairs of massless wormhole throats. Gauge bosons could develop 4-D mass squared but also remain massless in 4-D sense if the throats have parallel massless momenta. Longitudinal mass squared is however non-vanishing and p-adic thermodynamics predicts it.

### 3.5.2 The emergence of 2-D sub-dynamics at space-time level

Nima et al introduce ordering of the vertices in 4-D case. Ordering and related braiding are however essentially 2-D notions. Somehow 2-D theory must be a part of the 4-D theory also at space-time level, and I understood that understanding this is the challenge of the twistor approach at this moment.

The twistor amplitude can be represented as sum over the permutations of  $n$  external gluons and all diagrams corresponding to the same permutation are equivalent. Permutations are more like braidings since they carry information about how the permutation proceeded as a homotopy. Yang-Baxter equation emerges and states associativity of the braid group. The allowed braidings are minimal braidings in the sense that the repetitions of permutations of two adjacent vertices are not considered to be separate. Minimal braidings reduce to ordinary permutations. Nima also talks about affine braidings which I interpret as analogs of Kac-Moody algebras meaning that one uses projective representations which for Kac-Moody algebra mean non-trivial central extension. Perhaps the condition is that the square of a permutation permuting only two vertices which each other gives only a non-trivial phase factor. Lubos suggests an alternative interpretation which would select only special permutations and cannot be therefore correct.

There are rules of identifying the permutation associated with a given diagram involving only basic 3-gluon vertex with white circle and its conjugate. Lubos explains this "Mickey Mouse in maze" rule in his posting in detail: to determine the image  $p(n)$  of vertex  $n$  in the permutation put a mouse in the maze defined by the diagram and let it run around obeying single rule: if the vertex is black turn to the right and if the vertex is white turn to the left. The mouse cannot remain in a loop: if it would do so, the rule would force it to run back to  $n$  after single full loop and one would have a fixed point:  $p(n) = n$ . The reduction in the number of diagrams is enormous: the infinity of different diagrams reduces to  $n!$  diagrams!

What happens in TGD framework?

1. In TGD framework string world sheets and partonic 2-surfaces (or either or these if they are dual notions as conjectured) at space-time surface would define the sought for 2-D theory, and one obtains indeed perturbative expansion with fermionic propagator defined by the inverse of the modified Dirac operator and bosonic propagator defined by the correlation function for small deformations of the string world sheet. The vertices of twistor diagrams emerge as braid ends defining the intersections of string world sheets and partonic 2-surfaces.

String model like description becomes part of TGD and the role of string world sheets in  $X^4$  is highly analogous to that of string world sheets connecting branes in  $AdS^5 \times S^5$  of  $\mathcal{N} = 4$  SYM. In TGD framework 10-D  $AdS^5 \times S^5$  is replaced with 4-D space-time surface in  $M^4 \times CP_2$ . The meaning of the analog of  $AdS^5$  duality in TGD framework should be understood. In particular, it could it be that the descriptions involving string world sheets on one hand and partonic 2-surfaces - or 3-D orbits of wormhole throats defining the generalized Feynman diagram- on the other hand are dual to each other. I have conjectured something like this earlier but it takes some time for this kind of issues to find their natural answer.

2. As described in the article, string world sheets and partonic 2-surfaces emerge directly from the construction of the solutions of the modified Dirac equation by requiring conservation of em charge. This result has been conjectured already earlier but using other less direct arguments.

2-D "string world sheets" as sub-manifolds of the space-time surface make the ordering possible, and guarantee the finiteness of the perturbation theory involving n-point functions of a conformal QFT for fermions at wormhole throats and n-point functions for the deformations of the space-time surface. Conformal invariance should dictate these n-point functions to a high degree. In TGD framework the fundamental 3-vertex corresponds to joining of light-like orbits of three wormhole contacts along their 2-D ends (partonic 2-surfaces).

### 3.5.3 The emergence of Yangian symmetry

Yangian symmetry associated with the conformal transformations of  $M^4$  is a key symmetry of Grassmannian approach. Is it possible to derive it in TGD framework?

1. TGD indeed leads to a concrete representation of Yangian algebra as generalization of color and electroweak gauge Kac-Moody algebra using general formula discussed in Witten's article about Yangian algebras (see the article).
2. Article discusses also a conjecture about 2-D Hodge duality of quantized YM gauge potentials assignable to string world sheets with Kac-Moody currents. Quantum gauge potentials are defined only where they are needed - at string world sheets rather than entire 4-D space-time.
3. Conformal scalings of the effective metric defined by the anticommutators of the modified gamma matrices emerges as realization of quantum criticality. They are induced by critical deformations (second variations not changing Kähler action) of the space-time surface. This algebra can be generalized to Yangian using the formulas in Witten's article (see the article).
4. Critical deformations induce also electroweak gauge transformations and even more general symmetries for which infinitesimal generators are products of  $U(n)$  generators permuting  $n$  modes of the modified Dirac operator and infinitesimal generators of local electro-weak gauge transformations. These symmetries would relate in a natural manner to finite measurement resolution realized in terms of inclusions of hyperfinite factors with included algebra taking the role of gauge group transforming to each other states not distinguishable from each other.
5. How to end up with Grassmannian picture in TGD framework? This has inspired some speculations in the past. From Nima's lecture one however learns that Grassmannian picture emerges as a convenient parametrization. One starts from the basic 3-gluon vertex or its conjugate expressed in terms of twistors. Momentum conservation implies that with the three twistors  $\lambda_i$  or their conjugates are proportional to each other (depending on which is the case one assigns white or black dot with the vertex). This constraint can be expressed as a delta function constraint by introducing additional integration variables and these integration variables lead to the emergence of the Grassmannian  $G_{n,k}$  where  $n$  is the number of gluons, and  $k$  the number of positive helicity gluons.

Since only momentum conservation is involved, and since twistorial description works because only massless on mass shell virtual particles are involved, one is bound to end up with the Grassmannian description also in TGD.

### 3.5.4 The analog of $AdS^5$ duality in TGD framework

The generalization of  $AdS^5$  duality of  $\mathcal{N} = 4$  SYMs to TGD framework is highly suggestive and states that string world sheets and partonic 2-surfaces play a dual role in the construction of M-matrices. Some terminology first.

1. Let us agree that string world sheets and partonic 2-surfaces refer to 2-surfaces in the slicing of space-time region defined by Hermitian structure or Hamilton-Jacobi structure.
2. Let us also agree that *singular* string world sheets and partonic 2-surfaces are surfaces at which the *effective* metric defined by the anticommutators of the modified gamma matrices degenerates to effectively 2-D one.

3. Braid strands at wormhole throats in turn would be loci at which the *induced* metric of the string world sheet transforms from Euclidian to Minkowskian as the signature of induced metric changes from Euclidian to Minkowskian.

AdS<sup>5</sup> duality suggest that string world sheets are in the same role as string world sheets of 10-D space connecting branes in AdS<sup>5</sup> duality for  $\mathcal{N} = 4$  SYM. What is important is that there should exist a duality meaning two manners to calculate the amplitudes. What the duality could mean now?

1. Also in TGD framework the first manner would be string model like description using string world sheets. The second one would be a generalization of conformal QFT at light-like 3-surfaces (allowing generalized conformal symmetry) defining the lines of generalized Feynman diagram. The correlation functions to be calculated would have points at the intersections of partonic 2-surfaces and string world sheets and would represent braid ends.
2. General Coordinate Invariance (GCI) implies that physics should be codable by 3-surfaces. Light-like 3-surfaces define 3-surfaces of this kind and same applies to space-like 3-surfaces. There are also preferred 3-surfaces of this kind. The orbits of 2-D wormhole throats at which 4-metric degenerates to 3-dimensional one define preferred light-like 3-surfaces. Also the space-like 3-surfaces at the ends of space-time surface at light-like boundaries of causal diamonds (CDs) define preferred space-like 3-surfaces. Both light-like and space-like 3-surfaces should code for the same physics and therefore their intersections defining partonic 2-surfaces plus the 4-D tangent space data at them should be enough to code for physics. This is strong form of GCI implying effective 2-dimensionality. As a special case one obtains singular string world sheets at which the effective metric reduces to 2-dimensional and singular partonic 2-surfaces defining the wormhole throats. For these 2-surfaces situation could be especially simple mathematically.
3. The guess inspired by strong GCI is that string world sheet -partonic 2-surface duality holds true. The functional integrals over the deformations of 2 kinds of 2-surfaces should give the same result so that functional integration over either kinds of 2-surfaces should be enough. Note that the members of a given pair in the slicing intersect at discrete set of points and these points define braid ends carrying fermion number. Discretization and braid picture follow automatically.
4. Scattering amplitudes in the twistorial approach could be thus calculated by using *any* pair in the slicing - or only either member of the pair if the analog of AdS<sup>5</sup> duality holds true as argued. The possibility to choose any pair in the slicing means general coordinate invariance as a symmetry of the Kähler metric of WCW and of the entire theory suggested already early: Kähler functions for difference choices in the slicing would differ by a real part of holomorphic function and give rise to same Kähler metric of "world of classical worlds" (WCW). For a general pair one obtains functional integral over deformations of space-time surface inducing deformations of 2-surfaces with only other kind 2-surface contributing to amplitude. This means the analog of stringy QFT: Minkowskian or Euclidian string theory depending on choice.
5. For singular string world sheets and partonic 2-surfaces an enormous simplification results. The propagators for fermions and correlation functions for deformations reduce to 1-D instead of being 2-D: the propagation takes place only along the light-like lines at which the string world sheets with Euclidian signature (inside  $CP_2$  like regions) change to those with Minkowskian signature of induced metric. The local reduction of space-time dimension would be very real for particles moving along sub-manifolds at which higher dimensional space-time has reduced metric dimension: they cannot get out from lower-D sub-manifold. This is like ending down to 1-D black hole interior and one would obtain the analog of ordinary Feynman diagrammatics. This kind of Feynman diagrammatics involving only braid strands is what I have indeed ended up earlier so that it seems that I can trust good intuition combined with a sloppy mathematics sometimes works;-).

These singular lines represent orbits of point like particles carrying fermion number at the orbits of wormhole throats. Furthermore, in this representation the expansions coming from string world sheets and partonic 2-surfaces are identical automatically. This follows from the fact that only the light-like lines connecting points common to singular string world sheets and singular partonic 2-surfaces appear as propagator lines!

6. The TGD analog of AdS<sup>5</sup> duality of  $\mathcal{N} = 4$  SUSYs would be trivially true as an identity in this special case, and the good guess is that it is true also generally. One could indeed use integral over either string world sheets or partonic 2-sheets to deduce the amplitudes.

What is important to notice that singularities of Feynman diagrams crucial for the Grassmannian approach of Nima and others would correspond at space-time level 2-D singularities of the effective metric defined by the modified gamma matrices defined as contractions of canonical momentum currents for Kähler action with ordinary gamma matrices of the imbedding space and therefore directly reflecting classical dynamics.

### 3.5.5 Problems of the twistor approach from TGD point of view

Twistor approach has also its problems and here TGD suggests how to proceed. Signature problem is the first problem.

1. Twistor diagrammatics works in a strict mathematical sense only for  $M^{2,2}$  with metric signature (1,1,-1,-1) rather than  $M^4$  with metric signature (1,-1,-1,-1). Metric signature is wrong in the physical case. This is a real problem which must be solved eventually.
2. Effective metric defined by anticommutators of the modified gamma matrices (to be distinguished from the induced gamma matrices) could solve that problem since it would have the correct signature in TGD framework (see the article). String world sheets and partonic 2-surfaces would correspond to the 2-D singularities of this effective metric at which the even-even signature (1,1,1,1) changes to even-even signature (1,1,-1,-1). Space-time at string world sheet would become locally 2-D with respect to effective metric just as space-time becomes locally 3-D with respect to the induced metric at the light-like orbits of wormhole throats. String world sheets become also locally 1-D at light-like curves at which Euclidian signature of world sheet in induced metric transforms to Minkowskian.
3. Twistor amplitudes are indeed singularities and string world sheets implied in TGD framework by conservation of em charge would represent these singularities at space-time level. At the end of the talk Nima conjectured about lower-dimensional manifolds of space-time as representation of space-time singularities. Note that string world sheets and partonic 2-surfaces have been part of TGD for years. TGD is of course to  $\mathcal{N} = 4$  SYM what general relativity is for the special relativity. Space-time surface is dynamical and possesses induced and effective metrics rather than being flat.

Second limitation is that twistor diagrammatics works only for planar diagrams. This is a problem which must be also fixed sooner or later.

1. This perhaps dangerous and blasphemous statement that I will regret it some day but I will make it;-). Nima and others have not yet discovered that  $M^2 \subset M^4$  must be there but will discover it when they begin to generalize the results to non-planar diagrams and realize that Feynman diagrams are analogous to knot diagrams in 2-D plane (with crossings allowed) and that this 2-D plane must correspond to  $M^2 \subset M^4$ . The different choices of causal diamond  $CD$  correspond to different choices of  $M^2$  representing choice of quantization axes 4-momentum and spin. The integral over these choices guarantees Lorentz invariance. Gauge conditions are modified: longitudinal  $M^2$  projection of massless four-momentum is orthogonal to polarization so that three polarizations are possible: states are massive in longitudinal sense.
2. In TGD framework one replaces the lines of Feynman diagrams with the light-like 3-surfaces defining orbits of wormhole throats. These lines carry many fermion states defining braid strands at light-like 3-surfaces. There is internal braiding associated with these braid strands. String world sheets connect fermions at different wormhole throats with space-like braid strands. The  $M^2$  projections of generalized Feynman diagrams with 4-D "lines" replaced with genuine lines define the ordinary Feynman diagram as the analog of braid diagram. The conjecture is that one can reduce non-planar diagrams to planar diagrams using a procedure analogous to the construction of knot invariants by un-knotting the knot in Alexandrian manner by allowing it to be cut temporarily.



3. The permutations of string vertices emerge naturally as one constructs diagrams by adding to the interior of polygon sub-polygons connected to the external vertices. This corresponds to the addition of internal partonic two-surfaces. There are very many equivalent diagrams of this kind. Only permutations matter and the permutation associated with a given diagram of this kind can be deduced by the Mickey-Mouse rule described explicitly by Lubos. A connection with planar operads is highly suggestive and also conjecture already earlier in TGD framework.

### 3.5.6 Could $\mathcal{N} = 2$ or $\mathcal{N} = 4$ SUSY be a part of TGD after all?

Whether right-handed neutrinos generate a supersymmetry in TGD has been a long standing open question.  $\mathcal{N} = 1$  SUSY is certainly excluded by fermion number conservation but already  $\mathcal{N} = 2$  defining a "complexification" of  $\mathcal{N} = 1$  SUSY is possible and could generate right-handed neutrino and its antiparticle. These states should however possess a non-vanishing light-like momentum since the fully covariantly constant right-handed neutrino generates zero norm states. So called massless extremals (MEs) allow massless solutions of the modified Dirac equation for right-handed neutrino in the interior of space-time surface, and this seems to be case quite generally in Minkowskian signature for preferred extremals. This suggests that particle represented as magnetic flux tube structure with two wormhole contacts sliced between two MEs could serve as a starting point in attempts to understand the role of right handed neutrinos and how  $\mathcal{N} = 2$  or  $\mathcal{N} = 4$  SYM emerges at the level of space-time geometry. The following arguments inspired by the article of Nima Arkani-Hamed et al [?] about twistorial scattering amplitudes suggest a more detailed physical interpretation of the possible SUSY associated with the right-handed neutrinos.

The fact that right handed neutrinos have only gravitational interaction suggests a radical re-interpretation of SUSY: no SUSY breaking is needed since it is very difficult to distinguish between mass degenerate partners of ordinary particles. In order to distinguish between different partners one must be able to compare the gravitomagnetic energies of partners in slowly varying external gravimagnetic field: this effect is extremely small.

### Scattering amplitudes and the positive Grassmannian

The work of Nima Arkani-Hamed and others represents something which makes me very optimistic and I would be happy if I could understand the horrible technicalities of their work. The article Scattering Amplitudes and the Positive Grassmannian by Arkani-Hamed, Bourjaily, Cachazo, Goncharov, Postnikov, and Trnka [?] summarizes the recent situation in a form, which should be accessible to ordinary physicist. Lubos has already discussed the article. The following considerations do not relate much to the main message of the article (positive Grassmannians) but more to the question how this approach could be applied in TGD framework.

#### 1. All scattering amplitudes have on shell amplitudes for massless particles as building bricks

The key idea is that all planar amplitudes can be constructed from on shell amplitudes: all virtual particles are actually real. In zero energy ontology I ended up with the representation of TGD analogs of Feynman diagrams using only mass shell massless states with both positive and negative energies. The enormous number of kinematic constraints eliminates UV and IR divergences and also the description of massive particles as bound states of massless ones becomes possible.

In TGD framework quantum classical correspondence requires a space-time correlate for the on mass shell property and it indeed exists. The mathematically ill-defined path integral over all 4-surfaces is replaced with a superposition of preferred extremals of Kähler action analogous to Bohr orbits, and one has only a functional integral over the 3-D ends at the light-like boundaries of causal diamond (Euclidian/Minkowskian space-time regions give real/imaginary Chern-Simons exponent to the vacuum functional). This would be obviously the deeper principle behind on mass shell representation of scattering amplitudes that Nima and others are certainly trying to identify. This principle in turn reduces to general coordinate invariance at the level of the world of classical worlds.

Quantum classical correspondence and quantum ergodicity would imply even stronger condition: the quantal correlation functions should be identical with classical correlation functions for any preferred extremal in the superposition: all preferred extremals in the superposition would be statistically equivalent [?]. 4-D spin glass degeneracy of Kähler action however suggests that this is probably too strong a condition applying only to building bricks of the superposition.

Minimal surface property is the geometric counterpart for masslessness and the preferred extremals are also minimal surfaces: this property reduces to the generalization of complex structure at space-time surfaces, which I call Hamilton-Jacobi structure for the Minkowskian signature of the induced metric. Einstein Maxwell equations with cosmological term are also satisfied.

*2. Massless extremals and twistor approach*

The decomposition  $M^4 = M^2 \times E^2$  is fundamental in the formulation of quantum TGD, in the number theoretical vision about TGD, in the construction of preferred extremals, and for the vision about generalized Feynman diagrams. It is also fundamental in the decomposition of the degrees of string to longitudinal and transversal ones. An additional item to the list is that also the states appearing in thermodynamical ensemble in p-adic thermodynamics correspond to four-momenta in  $M^2$  fixed by the direction of the Lorentz boost. In twistor approach to TGD the possibility to decompose also internal lines to massless states at parallel space-time sheets is crucial.

Can one find a concrete identification for  $M^2 \times E^2$  decomposition at the level of preferred extremals? Could these preferred extremals be interpreted as the internal lines of generalized Feynman diagrams carrying massless momenta? Could one identify the mass of particle predicted by p-adic thermodynamics with the sum of massless classical momenta assignable to two preferred extremals of this kind connected by wormhole contacts defining the elementary particle?

Candidates for this kind of preferred extremals indeed exist. Local  $M^2 \times E^2$  decomposition and light-like longitudinal massless momentum assignable to  $M^2$  characterizes "massless extremals" (MEs, "topological light rays"). The simplest MEs correspond to single space-time sheet carrying a conserved light-like  $M^2$  momentum. For several MEs connected by wormhole contacts the longitudinal massless momenta are not conserved anymore but their sum defines a time-like conserved four-momentum: one has a bound states of massless MEs. The stable wormhole contacts binding MEs together possess Kähler magnetic charge and serve as building bricks of elementary particles. Particles are necessary closed magnetic flux tubes having two wormhole contacts at their ends and connecting the two MEs.

The sum of the classical massless momenta assignable to the pair of MEs is conserved even when they exchange momentum. Quantum classical correspondence requires that the conserved classical rest energy of the particle equals to the prediction of p-adic mass calculations. The massless momenta assignable to MEs would naturally correspond to the massless momenta propagating along the internal lines of generalized Feynman diagrams assumed in zero energy ontology. Masslessness of virtual particles makes also possible twistor approach. This supports the view that MEs are fundamental for the twistor approach in TGD framework.

*3. Scattering amplitudes as representations for braids whose threads can fuse at 3-vertices*

Just a little comment about the content of the article. The main message of the article is that non-equivalent contributions to a given scattering amplitude in  $\mathcal{N} = 4$  SYM represent elements of the group of permutations of external lines - or to be more precise - decorated permutations which replace permutation group  $S_n$  with  $n!$  elements with its decorated version containing  $2^n n!$  elements. Besides 3-vertex the basic dynamical process is permutation having the exchange of neighboring lines as a generating permutation completely analogous to fundamental braiding. BFCW bridge has interpretation as a representations for the basic braiding operation.

This supports the TGD inspired proposal (TGD as almost topological QFT) that generalized Feynman diagrams are in some sense also knot or braid diagrams allowing besides braiding operation also two 3-vertices [?]. The first 3-vertex generalizes the standard stringy 3-vertex but with totally different interpretation having nothing to do with particle decay: rather particle travels along two paths simultaneously after  $1 \rightarrow 2$  decay. Second 3-vertex generalizes the 3-vertex of ordinary Feynman diagram (three 4-D lines of generalized Feynman diagram identified as Euclidian space-time regions meet at this vertex). The main idea is that in TGD framework knotting and braiding emerges at two levels.

1. At the level of space-time surface string world sheets at which the induced spinor fields (except right-handed neutrino [?]) are localized due to the conservation of electric charge can form 2-knots and can intersect at discrete points in the generic case. The boundaries of strings world sheets at light-like wormhole throat orbits and at space-like 3-surfaces defining the ends of the space-time at light-like boundaries of causal diamonds can form ordinary 1-knots, and get linked and braided. Elementary particles themselves correspond to closed loops at the ends of

space-time surface and can also get knotted (possible effects are discussed in [?]).

2. One can assign to the lines of generalized Feynman diagrams lines in  $M^2$  characterizing given causal diamond. Therefore the 2-D representation of Feynman diagrams has concrete physical interpretation in TGD. These lines can intersect and what suggests itself is a description of non-planar diagrams (having this kind of intersections) in terms of an algebraic knot theory. A natural guess is that it is this knot theoretic operation which allows to describe also non-planar diagrams by reducing them to planar ones as one does when one constructs knot invariant by reducing the knot to a trivial one. Scattering amplitudes would be basically knot invariants.

"Almost topological" has also a meaning usually not assigned with it. Thurston's geometrization conjecture stating that geometric invariants of canonical representation of manifold as Riemann geometry, defined topological invariants, could generalize somehow. For instance, the geometric invariants of preferred extremals could be seen as topological or more refined invariants (symplectic, conformal in the sense of 4-D generalization of conformal structure). If quantum ergodicity holds true, the statistical geometric invariants defined by the classical correlation functions of various induced classical gauge fields for preferred extremals could be regarded as this kind of invariants for sub-manifolds. What would distinguish TGD from standard topological QFT would be that the invariants in question would involve length scale and thus have a physical content in the usual sense of the word!

### Could $\mathcal{N} = 2$ or $\mathcal{N} = 4$ SUSY have something to do with TGD?

$\mathcal{N} = 4$  SYM has been the theoretical laboratory of Nima and others.  $\mathcal{N} = 4$  SYM is definitely a completely exceptional theory, and one cannot avoid the question whether it could in some sense be part of fundamental physics. In TGD framework right handed neutrinos have remained a mystery: whether one should assign space-time SUSY to them or not. Could they give rise to something resembling  $\mathcal{N} = 2$  or  $\mathcal{N} = 4$  SUSY with fermion number conservation?

#### 1. Earlier results

My latest view is that *fully* covariantly constant right-handed neutrinos decouple from the dynamics completely. I will repeat first the earlier arguments which consider only fully covariantly constant right-handed neutrinos.

1.  $\mathcal{N} = 1$  SUSY is certainly excluded since it would require Majorana property not possible in TGD framework since it would require superposition of left and right handed neutrinos and lead to a breaking of lepton number conservation. Could one imagine SUSY in which both MEs between which particle wormhole contacts reside have  $\mathcal{N} = 2$  SUSY which combine to form an  $\mathcal{N} = 4$  SUSY?
2. Right-handed neutrinos which are covariantly constant right-handed neutrinos in both  $M^4$  degrees of freedom cannot define a non-trivial theory as shown already earlier. They have no electroweak nor gravitational couplings and carry no momentum, only spin.

The fully covariantly constant right-handed neutrinos with two possible helicities at given ME would define representation of SUSY at the limit of vanishing light-like momentum. At this limit the creation and annihilation operators creating the states would have vanishing anticommutator so that the oscillator operators would generate Grassmann algebra. Since creation and annihilation operators are hermitian conjugates, the states would have zero norm and the states generated by oscillator operators would be pure gauge and decouple from physics. This is the core of the earlier argument demonstrating that  $\mathcal{N} = 1$  SUSY is not possible in TGD framework: LHC has given convincing experimental support for this belief.

#### 2. Could massless right-handed neutrinos covariantly constant in $CP_2$ degrees of freedom define $\mathcal{N} = 2$ or $\mathcal{N} = 4$ SUSY?

Consider next right-handed neutrinos, which are covariantly constant in  $CP_2$  degrees of freedom but have a light-like four-momentum. In this case fermion number is conserved but this is consistent with  $\mathcal{N} = 2$  SUSY at both MEs with fermion number conservation.  $\mathcal{N} = 2$  SUSYs could emerge from  $\mathcal{N} = 4$  SUSY when one half of SUSY generators annihilate the states, which is a basic phenomenon in supersymmetric theories.

1. At space-time level right-handed neutrinos couple to the space-time geometry - gravitation - although weak and color interactions are absent. One can say that this coupling forces them to move with light-like momentum parallel to that of ME. At the level of space-time surface right-handed neutrinos have a spectrum of excitations of four-dimensional analogs of conformal spinors at string world sheet (Hamilton-Jacobi structure).

For MEs one indeed obtains massless solutions depending on longitudinal  $M^2$  coordinates only since the induced metric in  $M^2$  differs from the light-like metric only by a contribution which is light-like and contracts to zero with light-like momentum in the same direction. These solutions are analogs of (say) left movers of string theory. The dependence on  $E^2$  degrees of freedom is holomorphic. That left movers are only possible would suggest that one has only single helicity and conservation of fermion number at given space-time sheet rather than 2 helicities and non-conserved fermion number: two real Majorana spinors combine to single complex Weyl spinor.

2. At imbedding space level one obtains a tensor product of ordinary representations of  $\mathcal{N} = 2$  SUSY consisting of Weyl spinors with opposite helicities assigned with the ME. The state content is same as for a reduced  $\mathcal{N} = 4$  SUSY with four  $\mathcal{N} = 1$  Majorana spinors replaced by two complex  $\mathcal{N} = 2$  spinors with fermion number conservation. This gives 4 states at both space-time sheets constructed from  $\nu_R$  and its antiparticle. Altogether the two MEs give 8 states, which is one half of the 16 states of  $\mathcal{N} = 4$  SUSY so that a degeneration of this symmetry forced by non-Majorana property is in question.

3. *Is the dynamics of  $\mathcal{N} = 2$  or  $\mathcal{N} = 4$  SYM possible in right-handed neutrino sector?*

Could  $\mathcal{N} = 2$  or  $\mathcal{N} = 4$  SYM be a part of quantum TGD? Could TGD be seen a fusion of a degenerate  $\mathcal{N} = 4$  SYM describing the right-handed neutrino sector and string theory like theory describing the contribution of string world sheets carrying other leptonic and quark spinors? Or could one imagine even something simpler?

What is interesting that the net momenta assigned to the right handed neutrinos associated with a pair of MEs would correspond to the momenta assignable to the particles and obtained by p-adic mass calculations. It would seem that right-handed neutrinos provide a representation of the momenta of the elementary particles represented by wormhole contact structures. Does this mimicry generalize to a full duality so that all quantum numbers and even microscopic dynamics of defined by generalized Feynman diagrams (Euclidian space-time regions) would be represented by right-handed neutrinos and MEs? Could a generalization of  $\mathcal{N} = 4$  SYM with non-trivial gauge group with proper choices of the ground states helicities allow to represent the entire microscopic dynamics?

Irrespective of the answer to this question one can compare the TGD based view about supersymmetric dynamics with what I have understood about  $\mathcal{N} = 4$  SYM.

1. In the scattering of MEs induced by the dynamics of Kähler action the right-handed neutrinos play a passive role. Modified Dirac equation forces them to adopt the same direction of four-momentum as the MEs so that the scattering reduces to the geometric scattering for MEs as one indeed expects on basis of quantum classical correspondence. In  $\nu_R$  sector the basic scattering vertex involves four MEs and could be a re-sharing of the right-handed neutrino content of the incoming two MEs between outgoing two MEs respecting fermion number conservation. Therefore  $\mathcal{N} = 4$  SYM with fermion number conservation would represent the scattering of MEs at quantum level.
2.  $\mathcal{N} = 4$  SUSY would suggest that also in the degenerate case one obtains the full scattering amplitude as a sum of permutations of external particles followed by projections to the directions of light-like momenta and that BCFW bridge represents the analog of fundamental braiding operation. The decoration of permutations means that each external line is effectively doubled. Could the scattering of MEs can be interpreted in terms of these decorated permutations? Could the doubling of permutations by decoration relate to the occurrence of pairs of MEs?

One can also revert these questions. Could one construct massive states in  $\mathcal{N} = 4$  SYM using pairs of momenta associated with particle with integer label  $k$  and its decorated copy with label  $k+n$ ? Massive external particles obtained in this manner as bound states of massless ones could solve the IR divergence problem of  $\mathcal{N} = 4$  SYM.

3. The description of amplitudes in terms of leading singularities means picking up of the singular contribution by putting the fermionic propagators on mass shell. In the recent case it would give the inverse of massless Dirac propagator acting on the spinor at the end of the internal line annihilating it if it is a solution of Dirac equation.

The only way out is a kind of cohomology theory in which solutions of Dirac equation represent exact forms. Dirac operator defines the exterior derivative  $d$  and virtual lines correspond to non-physical helicities with  $d\Psi \neq 0$ . Virtual fermions would be on mass-shell fermions with non-physical polarization satisfying  $d^2\Psi = 0$ . External particles would be those with physical polarization satisfying  $d\Psi = 0$ , and one can say that the Feynman diagrams containing physical helicities split into products of Feynman diagrams containing only non-physical helicities in internal lines.

4. The fermionic states at wormhole contacts should define the ground states of SUSY representation with helicity  $+1/2$  and  $-1/2$  rather than spin 1 or  $-1$  as in standard realization of  $\mathcal{N} = 4$  SYM used in the article. This would modify the theory but the twistorial and Grassmannian description would remain more or less as such since it depends on light-likeness and momentum conservation only.

#### 4. 3-vertices for sparticles are replaced with 4-vertices for MEs

In  $\mathcal{N} = 4$  SYM the basic vertex is on mass-shell 3-vertex which requires that for real light-like momenta all 3 states are parallel. One must allow complex momenta in order to satisfy energy conservation and light-likeness conditions. This is strange from the point of view of physics although number theoretically oriented person might argue that the extensions of rationals involving also imaginary unit are rather natural.

The complex momenta can be expressed in terms of two light-like momenta in 3-vertex with one real momentum. For instance, the three light-like momenta can be taken to be  $p, k$ , and  $p - ka$  with  $k = ap_R$ . Here  $p$  (incoming momentum) and  $p_R$  are real light-like momenta satisfying  $p \cdot p_R = 0$  but with opposite sign of energy, and  $a$  is complex number. What is remarkable that also the negative sign of energy is necessary also now.

In zero energy ontology the situation is different due to the presence of a pair of MEs, the allowance of negative energies in internal lines, and the fact that scattering is of sparticles is induced by that of MEs. In the simplest vertex a massive external particle with non-parallel MEs carrying non-parallel light-like momenta can decay to a pair of MEs with light-like momenta. This can be interpreted as 4-ME-vertex rather than 3-vertex (say) BFF so that complex momenta are not needed. For an incoming boson identified as wormhole contact the vertex can be seen as BFF vertex.

To obtain space-like momentum exchanges one must allow negative sign of energy and one has strong conditions coming from momentum conservation and light-likeness which allow non-trivial solutions since the basically 4-vertices are in question. This reduces dramatically the number of graphs. Note that one can also consider vertices in which three pairs of MEs join along their ends so that 6 MEs (analog of 3-bson vertex) would be involved.

#### 5. Is SUSY breaking possible or needed?

It is difficult to imagine the breaking of the proposed kind of SUSY in TGD framework, and the first guess is that all these 4 super-partners of particle have identical masses. p-Adic thermodynamics does not distinguish between these states and the only possibility is that the p-adic primes differ for the spartners. But is the breaking of SUSY really necessary? Can one really distinguish between the 8 different states of a given elementary particle using the recent day experimental methods?

1. In electroweak and color interactions the spartners behave in an identical manner classically. The coupling of right-handed neutrinos to space-time geometry however forces the right-handed neutrinos to adopt the same direction of four-momentum as MEs has. Could some gravitational effect allow to distinguish between spartners? This would be trivially the case if the p-adic mass scales of spartners would be different. Why this should be the case remains however an open question.
2. In the case of unbroken SUSY only spin distinguishes between spartners. Spin determines statistics and the first naive guess would be that bosonic spartners obey totally different atomic

physics allowing condensation of selectrons to the ground state. Very probably this is not true: the right-handed neutrinos are delocalized to 4-D MEs and other fermions correspond to wormhole contact structures and 2-D string world sheets.

The coupling of the spin to the space-time geometry seems to provide the only possible manner to distinguish between spartners. Could one imagine a gravimagnetic effect with energy splitting proportional to the product of gravimagnetic moment and external gravimagnetic field  $B$ ? If gravimagnetic moment is proportional to spin projection in the direction of  $B$ , a non-trivial effect would be possible. Needless to say this kind of effect is extremely small so that the unbroken SUSY might remain undetected.

3. If the spin of sparticle be seen in the classical angular momentum of ME as quantum classical correspondence would suggest then the value of the angular momentum might allow to distinguish between spartners. Also now the effect is extremely small.

### 3.6 $M^8 - H$ duality, preferred extremals, criticality, and Mandelbrot fractals

$M^8 - H$  duality [K72] represents an intriguing connection between number theory and TGD but the mathematics involved is extremely abstract and difficult so that I can only represent conjectures. In the following the basic duality is used to formulate a general conjecture for the construction of preferred extremals by iterative procedure. What is remarkable and extremely surprising is that the iteration gives rise to the analogs of Mandelbrot fractals and space-time surfaces can be seen as fractals defined as fixed sets of iteration. The analogy with Mandelbrot set can be also seen as a geometric correlate for quantum criticality.

#### 3.6.1 $M^8 - H$ duality briefly

$M^8 - M^4 \times CP_2$  duality [?] states that certain 4-surfaces of  $M^8$  regarded as a sub-space of complexified octonions can be mapped in a natural manner to 4-surfaces in  $M^4 \times CP_2$ : this would mean that  $M^4 \times CP_2$  and therefore also the symmetries of standard model would have purely number theoretical meaning.

Consider a distribution of two planes  $M^2(x)$  integrating to a 2-surface  $\tilde{M}^2$  with the property that a fixed 1-plane  $M^1$  defining time axis globally is contained in each  $M^2(x)$  and therefore in  $\tilde{M}^2$ .  $M^1$  defines real axis of octonionic plane  $M^8$  and  $M^2(x)$  a local hyper-complex plane. Quaternionic subspaces with this property can be parameterized by points of  $CP_2$ : this leads to  $M^8 - H$  duality as can be shown by a simple argument.

1. Hyper-octonionic subspace of complexified octonions is obtained by multiplying octonionic imaginary units by commuting imaginary unit. This does not bring anything new as far as automorphisms are considered so that it is enough to consider octonions (so that  $M^2$  is replaced with  $C$ ). Octonionic frame consists of orthogonal octonionic units. The space of octonionic frames containing sub-frame spanning fixed  $C$  is parameterized by  $SU(3)$ . The reason is that complexified octonionic units can be decomposed to the representations of  $SU(3) \subset G_2$  as  $1 + 1 + 3 + \bar{3}$  and the sub-frame 1+1 spans the preferred  $C$ .
2. The quaternionic planes  $H$  are represented by frames defined by four unit octonions spanning a quaternionic plane. Fixing  $C \subset H$  means fixing the 1+1 part in the above decomposition. The sub-group of  $SU(3)$  leaving the plane  $H$  invariant can perform only a rotation in the plane defined by two quaternionic units in 3. This sub-group is  $U(2)$  so that the space of quaternionic planes  $H \supset C$  is parameterized by  $SU(3)/U(2) = CP_2$ .
3. Therefore quaternionic tangent plane  $H \supset C$  can be mapped to a point of  $CP_2$ . In particular, any quaternionic surface in  $E^8$ , whose tangent plane at each point is quaternionic and contains  $C$ , can be mapped to  $E^4 \times CP_2$  by mapping the point  $(e_1, e_2) \in E^4 \times E^4$  to  $(e_1, s) \in E^4 \times CP_2$ . The generalization from  $E^8$  to  $M^8$  is trivial. This is essentially what  $M^8 - H$  duality says.

This can be made more explicit. Define quaternionic surfaces in  $M^8$  as 4-surfaces, whose tangent plane is quaternionic at each point  $x$  and contains the local hyper-complex plane  $M^2(x)$  and is therefore labelled by a point  $s(x) \in CP_2$ . One can write these surfaces as union over 2-D surfaces associated with points of  $\tilde{M}^2$ :

$$X^4 = \cup_{x \in \tilde{M}^2} X^2(x) \subset E^6 .$$

These surfaces can be mapped to surfaces of  $M^4 \times CP_2$  via the correspondence  $(m(x), e(x)) \rightarrow (m, s(T(X^4(x))))$ . Also the image surface contains at given point  $x$  the preferred plane  $M^2(x) \supset M^1$ . One can also write these surfaces as union over 2-D surfaces associated with points of  $\tilde{M}^2$ :

$$X^4 = \cup_{x \in \tilde{M}^2} X^2(x) \subset E^2 \times CP_2 .$$

One can also ask what are the conditions under which one can map surfaces  $X^4 = \cup_{x \in \tilde{M}^2} X^2 \subset E^2 \times CP_2$  to 4-surfaces in  $M^8$ . The map would be given by  $(m, s) \rightarrow (m, T^4(s))$  and the surface would be of the form as already described. The surface  $X^4$  must be such that the distribution of 4-D tangent planes defined in  $M^8$  is integrable and this gives complicated integrability conditions. One might hope that the conditions might hold true for preferred extremals satisfying some additional conditions.

One must make clear that the conditions discussed above do not allow most general possible surface.

1. The point is that for preferred extremals with Euclidian signature of metric the  $M^4$  projection is 3-dimensional and involves light like projection. Here the fact that light-like line  $L \subset M^2$  spans  $M^2$  in the sense that the complement of its orthogonal complement in  $M^8$  is  $M^2$ . Therefore one could consider also more general solution ansatz for which one has

$$X^4 = \cup_{x \in L(x) \subset \tilde{M}^2} X^3(x) \subset E^2 \times CP_2 .$$

2. One can also consider co-quaternionic surfaces as surfaces for which tangent space is in the dual of a quaternionic subspace. This says that the normal bundle rather than tangent bundle is quaternionic. The space-time regions with Euclidian signature of induced metric correspond naturally to co-quaternionic surfaces. Quaternionic surfaces are maximal associative sub-manifolds of octonionic space and one of the key ideas of the number theoretic vision about TGD is that associativity (co-associativity) defines the dynamics of space-time surfaces. That this dynamics gives preferred extremals of Kähler action remains to be proven.

### 3.6.2 The integrability conditions

The integrability conditions are associated with the expression of tangent vectors of  $T(X^4)$  as a linear combination of coordinate gradients  $\nabla m^k$ , where  $m^k$  denote the coordinates of  $M^8$ . Consider the 4 tangent vectors  $e_i$  for the quaternionic tangent plane (containing  $M^2(x)$ ) regarded as vectors of  $M^8$ .  $e_i$  have components  $e_i^k$ ,  $i = 1, \dots, 4$ ,  $k = 1, \dots, 8$ . One must be able to express  $e_i$  as linear combinations of coordinate gradients  $\nabla m^k$ :

$$e_i^k = e_i^\alpha \partial_\alpha m^k .$$

Here  $x^\alpha$  and  $e^k$  denote coordinates for  $X^4$  and  $M^8$ . By forming inner products of  $e_i$  one finds that matrix  $e_i^\alpha$  represents the components of vierbein at  $X^4$ . One can invert this matrix to get  $e_\alpha^i$  satisfying  $e_\alpha^i e_i^\beta = \delta_\alpha^\beta$  and  $e_\alpha^i e_j^\alpha = \delta_j^i$ . One can solve the coordinate gradients  $\nabla m^k$  from above equation to get

$$\partial_\alpha m^k = e_\alpha^i e_i^k \equiv E_\alpha^k .$$

The integrability conditions follow from the gradient property and state

$$D_\alpha E_\beta^k = D_\beta E_\alpha^k .$$

One obtains  $8 \times 6 = 48$  conditions in the general case. The slicing to a union of two-surfaces labeled by  $M^2(x)$  reduces the number of conditions since the number of coordinates  $m^k$  reduces from 8 to 6

and one has 36 integrability conditions but still them is much larger than the number of free variables—essentially the six transversal coordinates  $m^k$ .

For co-quaternionic surfaces one can formulate integrability conditions now as conditions for the existence of integrable distribution of orthogonal complements for tangent planes and it seems that the conditions are formally similar.

### 3.6.3 How to solve the integrability conditions and field equations for preferred extremals?

The basic idea has been that the integrability condition characterize preferred extremals so that they can be said to be quaternionic in a well-defined sense. Could one imagine solving the integrability conditions by some simple ansatz utilizing the core idea of  $M^8 - H$  duality? What comes in mind is that  $M^8$  represents tangent space of  $M^4 \times CP_2$  so that one can assign to any point  $(m, s)$  of 4-surface  $X^4 \subset M^4 \times CP_2$  a tangent plane  $T^4(x)$  in its tangent space  $M^8$  identifiable as subspace of complexified octonions in the proposed manner. Assume that  $s \in CP_2$  corresponds to a fixed tangent plane containing  $M^2(x)$ , and that all planes  $M^2(x)$  are mapped to the same standard fixed hyperoctonionic plane  $M^2 \subset M^8$ , which does not depend on  $x$ . This guarantees that  $s$  corresponds to a unique quaternionic tangent plane for given  $M^2(x)$ .

Consider the map  $T \circ s$ . The map takes the tangent plane  $T^4$  at point  $(m, e) \in M^4 \times E^4$  and maps it to  $(m, s_1 = s(T^4)) \in M^4 \times CP_2$ . The obvious identification of quaternionic tangent plane at  $(m, s_1)$  would be as  $T^4$ . One would have  $T \circ s = Id$ . One could do this for all points of the quaternion surface  $X^4 \subset E^4$  and hope of getting smooth 4-surface  $X^4 \subset H$  as a result. This is the case if the integrability conditions at various points  $(m, s(T^4)(x)) \in H$  are satisfied. One could equally well start from a quaternionic surface of  $H$  and end up with integrability conditions in  $M^8$  discussed above. The geometric meaning would be that the quaternionic surface in  $H$  is image of quaternionic surface in  $M^8$  under this map.

Could one somehow generalize this construction so that one could iterate the map  $T \circ s$  to get  $T \circ s = Id$  at the limit? If so, quaternionic space-time surfaces would be obtained as limits of iteration for rather arbitrary space-time surface in either  $M^8$  or  $H$ . One can also consider limit cycles, even limiting manifolds with finite-dimension which would give quaternionic surfaces. This would give a connection with chaos theory.

1. One could try to proceed by discretizing the situation in  $M^8$  and  $H$ . One does not fix quaternionic surface at either side but just considers for a fixed  $m_2 \in M^2(x)$  a discrete collection  $X \{(T_i^4) \supset M^2(x)$  of quaternionic planes in  $M^8$ . The points  $e_{2,i} \in E^2 \subset M^2 \times E^2 = M^4$  are not fixed. One can also assume that the points  $s_i = s(T_i^4)$  of  $CP_2$  defined by the collection of planes form in a good approximation a cubic lattice in  $CP_2$  but this is not absolutely essential. Complex Eguchi-Hanson coordinates  $\xi^i$  are natural choice for the coordinates of  $CP_2$ . Assume also that the distances between the nearest  $CP_2$  points are below some upper limit.
2. Consider now the iteration. One can map the collection  $X$  to  $H$  by mapping it to the set  $s(X)$  of pairs  $((m_2, s_i)$ . Next one must select some candidates for the points  $e_{2,i} \in E^2 \subset M^4$  somehow. One can define a piece-wise linear surface in  $M^4 \times CP_2$  consisting of 4-planes defined by the nearest neighbors of given point  $(m_2, e_{2,i}, s_i)$ . The coordinates  $e_{2,i}$  for  $E^2 \subset M^4$  can be chosen rather freely. The collection  $(e_{2,i}, s_i)$  defines a piece-wise linear surface in  $H$  consisting of four-cubes in the simplest case. One can hope that for certain choices of  $e_{2,i}$  the four-cubes are quaternionic and that there is some further criterion allowing to choose the points  $e_{2,i}$  uniquely. The tangent planes contain by construction  $M^2(x)$  so that the product of remaining two spanning tangent space vectors  $(e_3, e_4)$  must give an element of  $M^2$  in order to achieve quaternionicity. Another natural condition would be that the resulting tangent planes are not only quaternionic but also as near as possible to the planes  $T_i^4$ . These conditions allow to find  $e_{2,i}$  giving rise to geometrically determined quaternionic tangent planes as near as possible to those determined by  $s^i$ .
3. What to do next? Should one replace the quaternionic planes  $T_i^4$  with geometrically determined quaternionic planes as near as possible to them and map them to points  $s_i$  slightly different from the original one and repeat the procedure? This would not add new points to the approximation, and this is an unsatisfactory feature.



4. Second possibility is based on the addition of the quaternionic tangent planes obtained in this manner to the original collection of quaternionic planes. Therefore the number of points in discretization increases and the added points of  $CP_2$  are as near as possible to existing ones. One can again determine the points  $e_{2,i}$  in such a manner that the resulting geometrically determined quaternionic tangent planes are as near as possible to the original ones. This guarantees that the algorithm converges.
5. The iteration can be stopped when desired accuracy is achieved: in other words the geometrically determined quaternionic tangent planes are near enough to those determined by the points  $s_i$ . Also limit cycles are possible and would be assignable to the transversal coordinates  $e_{2i}$  varying periodically during iteration. One can quite well allow this kind of cycles, and they would mean that  $e_2$  coordinate as a function of  $CP_2$  coordinates characterizing the tangent plane is many-valued. This is certainly very probable for solutions representable locally as graphs  $M^4 \rightarrow CP_2$ . In this case the tangent planes associated with distant points in  $E^2$  would be strongly correlated which must have non-trivial physical implications. The iteration makes sense also p-adically and it might be that in some cases only p-adic iteration converges for some value of  $p$ .

It is not obvious whether the proposed procedure gives rise to a smooth or even continuous 4-surface. The conditions for this are geometric analogs of the above described algebraic integrability conditions for the map assigning to the surface in  $M^4 \times CP_2$  a surface in  $M^8$ . Therefore  $M^8 - H$  duality could express the integrability conditions and preferred extremals would be 4-surfaces having counterparts also in the tangent space  $M^8$  of  $H$ .

One might hope that the self-referentiality condition  $s \circ T = Id$  for the  $CP_2$  projection of  $(m, s)$  or its fractal generalization could solve the complicated integrability conditions for the map  $T$ . The image of the space-time surface in tangent space  $M^8$  in turn could be interpreted as a description of space-time surface using coordinates defined by the local tangent space  $M^8$ . Also the analogy for the duality between position and momentum suggests itself.

Is there any hope that this kind of construction could make sense? Or could one demonstrate that it fails? If  $s$  would fix completely the tangent plane it would be probably easy to kill the conjecture but this is not the case. Same  $s$  corresponds for different planes  $M^2(x)$  to different point tangent plane. Presumably they are related by a local  $G_2$  or  $SO(7)$  rotation. Note that the construction can be formulated without any reference to the representation of the imbedding space gamma matrices in terms of octonions. Complexified octonions are enough in the tangent space of  $M^8$ .

### 3.6.4 Connection with Mandelbrot fractal and fractals as fixed sets for iteration

The occurrence of iteration in the construction of preferred extremals suggests a deep connection with the standard construction of 2-D fractals by iteration - about which Mandelbrot fractal [?, ?] is the canonical example.  $X^2(x)$  (or  $X^3(x)$  in the case of light-like  $L(x) \subset M^2(x)$ ) could be identified as a union of orbits for the iteration of  $s \circ T$ . The appearance of the iteration map in the construction of solutions of field equation would answer positively to a long standing question whether the extremely beautiful mathematics of 2-D fractals could have some application at the level of fundamental physics according to TGD.

$X^2$  (or  $X^3$ ) would be completely analogous to Mandelbrot set in the sense that it would be boundary separating points in two different basis of attraction. In the case of Mandelbrot set iteration would take points at the other side of boundary to origin on the other side and to infinity. The points of Mandelbrot set are permuted by the iteration. In the recent case  $s \circ T$  maps  $X^2$  (or  $X^3$ ) to itself. This map need not be diffeomorphism or even continuous map. The criticality of  $X^2$  (or  $X^3$ ) could be seen as a geometric correlate for quantum criticality.

In fact, iteration plays a very general role in the construction of fractals. Very general fractals can be defined as fixed sets of iteration and simple rules for iteration produce impressive representations for fractals appearing in Nature. The book of Michael Barnsley [?] gives fascinating pictures about fractals appearing in Nature using this method. Therefore it would be highly satisfactory if space-time surfaces would be in a well-defined sense fixed sets of iteration. This would be also numerically beautiful aspect since fixed sets of iteration can be obtained as infinite limit of iteration for almost arbitrary initial set. This construction recipe would also give a concrete content for the notion measurement resolution at the level of construction of preferred extremals.

What is intriguing is that there are several very attractive approaches to the construction of preferred extremals. The challenge of unifying them still remains to be met.

### 3.7 Do geometric invariants of preferred extremals define topological invariants of space-time surface and code for quantum physics?

The recent progress in the understanding of preferred extremals [K9] led to a reduction of the field equations to conditions stating for Euclidian signature the existence of Kähler metric. The resulting conditions are a direct generalization of corresponding conditions emerging for the string world sheet and stating that the 2-metric has only non-diagonal components in complex/hypercomplex coordinates. Also energy momentum of Kähler action and has this characteristic (1,1) tensor structure. In Minkowskian signature one obtains the analog of 4-D complex structure combining hyper-complex structure and 2-D complex structure.

The construction lead also to the understanding of how Einstein's equations with cosmological term follow as a consistency condition guaranteeing that the covariant divergence of the Maxwell's energy momentum tensor assignable to Kähler action vanishes. This gives  $T = kG + \Lambda g$ . By taking trace a further condition follows from the vanishing trace of  $T$ :

$$R = \frac{4\Lambda}{k} . \tag{3.7.1}$$

That any preferred extremal should have a constant Ricci scalar proportional to cosmological constant is very strong prediction. Note however that both  $\Lambda$  and  $k \propto 1/G$  are both parameters characterizing one particular preferred extremal. One could of course argue that the dynamics allowing only constant curvature space-times is too simple. The point is however that particle can topologically condense on several space-time sheets meaning effective superposition of various classical fields defined by induced metric and spinor connection.

The following considerations demonstrate that preferred extremals can be seen as canonical representatives for the constant curvature manifolds playing central role in Thurston's geometrization theorem [?] known also as hyperbolization theorem implying that geometric invariants of space-time surfaces transform to topological invariants. The generalization of the notion of Ricci flow to Maxwell flow in the space of metrics and further to Kähler flow for preferred extremals in turn gives a rather detailed vision about how preferred extremals organize to one-parameter orbits. It is quite possible that Kähler flow is actually discrete. The natural interpretation is in terms of dissipation and self organization. Somewhat surprisingly, hyperbolization theorem stating that very many 4-manifolds allow a metric with negative constant curvature gives a first principle explanation for the small negative value of cosmological constant implying accelerated cosmic expansion!

Quantum classical correspondence suggests that this line of thought could be continued even further: could the geometric invariants of the preferred extremals code not only for space-time topology but also for quantum physics? How to calculate the correlation functions and coupling constant evolution has remained a basic unresolved challenge of quantum TGD. Could the correlation functions be reduced to statistical geometric invariants of preferred extremals? The latest (means the end of 2012) and perhaps the most powerful idea hitherto about coupling constant evolution is quantum classical correspondence in statistical sense stating that the statistical properties of a preferred extremal in quantum superposition of them are same as those of the zero energy state in question. This principle would be quantum generalization of ergodic theorem stating that the time evolution of a single member of ensemble represents the ensemble statistically. This principle would allow to deduce correlation functions and S-matrix from the statistical properties of single preferred extremal alone using classical intuition. Also coupling constant evolution would be coded by the statistical properties of the representative preferred extremal.

### 3.7.1 Preferred extremals of Kähler action as manifolds with constant Ricci scalar whose geometric invariants are topological invariants

An old conjecture inspired by the preferred extremal property is that the geometric invariants of space-time surface serve as topological invariants. The reduction of Kähler action to 3-D Chern-Simons terms [K9] gives support for this conjecture as a classical counterpart for the view about TGD as almost topological QFT. The following arguments give a more precise content to this conjecture in terms of existing mathematics.

1. It is not possible to represent the scaling of the induced metric as a deformation of the space-time surface preserving the preferred extremal property since the scale of  $CP_2$  breaks scale invariance. Therefore the curvature scalar cannot be chosen to be equal to one numerically. Therefore also the parameter  $R = 4\Lambda/k$  and also  $\Lambda$  and  $k$  separately characterize the equivalence class of preferred extremals as is also physically clear.

Also the volume of the space-time sheet closed inside causal diamond  $CD$  remains constant along the orbits of the flow and thus characterizes the space-time surface.  $\Lambda$  and even  $k \propto 1/G$  can indeed depend on space-time sheet and p-adic length scale hypothesis suggests a discrete spectrum for  $\Lambda/k$  expressible in terms of p-adic length scales:  $\Lambda/k \propto 1/L_p^2$  with  $p \simeq 2^k$  favored by p-adic length scale hypothesis. During cosmic evolution the p-adic length scale would increase gradually. This would resolve the problem posed by cosmological constant in GRT based theories.

2. One could also see the preferred extremals as 4-D counterparts of constant curvature 3-manifolds in the topology of 3-manifolds. An interesting possibility raised by the observed negative value of  $\Lambda$  is that most 4-surfaces are constant negative curvature 4-manifolds. By a general theorem coset spaces  $H^4/\Gamma$ , where  $H^4 = SO(1,4)/SO(4)$  is hyperboloid of  $M^5$  and  $\Gamma$  a torsion free discrete subgroup of  $SO(1,4)$  [?]. It is not clear to me, whether the constant value of Ricci scalar implies constant sectional curvatures and therefore hyperbolic space property. It could happen that the space of spaces with constant Ricci curvature contain a hyperbolic manifold as an especially symmetric representative. In any case, the geometric invariants of hyperbolic metric are topological invariants.

By Mostow rigidity theorem [?] finite-volume hyperbolic manifold is unique for  $D > 2$  and determined by the fundamental group of the manifold. Since the orbits under the Kähler flow preserve the curvature scalar the manifolds at the orbit must represent different imbeddings of one and hyperbolic 4-manifold. In 2-D case the moduli space for hyperbolic metric for a given genus  $g > 0$  is defined by Teichmueller parameters and has dimension  $6(g - 1)$ . Obviously the exceptional character of  $D = 2$  case relates to conformal invariance. Note that the moduli space in question plays a key role in p-adic mass calculations [K16].

In the recent case Mostow rigidity theorem could hold true for the Euclidian regions and maybe generalize also to Minkowskian regions. If so then both "topological" and "geometro" in "Topological GeometroDynamics" would be fully justified. The fact that geometric invariants become topological invariants also conforms with "TGD as almost topological QFT" and allows the notion of scale to find its place in topology. Also the dream about exact solvability of the theory would be realized in rather convincing manner.

These conjectures are the main result independent of whether the generalization of the Ricci flow discussed in the sequel exists as a continuous flow or possibly discrete sequence of iterates in the space of preferred extremals of Kähler action. My sincere hope is that the reader could grasp how far reaching these result really are.

### 3.7.2 Is there a connection between preferred extremals and AdS<sub>4</sub>/CFT correspondence?

The preferred extremals satisfy Einstein Maxwell equations with a cosmological constant and have negative curvature for negative value of  $\Lambda$ . 4-D space-times with hyperbolic metric provide canonical representation for a large class of four-manifolds and an interesting question is whether these spaces are obtained as preferred extremals and/or vacuum extremals.

4-D hyperbolic space with Minkowski signature is locally isometric with  $\text{AdS}_4$ . This suggests at connection with  $\text{AdS}_4/\text{CFT}$  correspondence of M-theory. The boundary of AdS would be now replaced with 3-D light-like orbit of partonic 2-surface at which the signature of the induced metric changes. The metric 2-dimensionality of the light-like surface makes possible generalization of 2-D conformal invariance with the light-like coordinate taking the role of complex coordinate at light-like boundary. AdS would presumably represent a special case of a more general family of space-time surfaces with constant Ricci scalar satisfying Einstein-Maxwell equations and generalizing the  $\text{AdS}_4/\text{CFT}$  correspondence.

This gives motivations for finding whether  $\text{AdS}_4$  allows an imbedding as a vacuum extremal to  $M^4 \times S^2 \subset M^4 \times CP_2$ , where  $S^2$  is a homologically trivial geodesic sphere of  $CP_2$ . It is easy to guess the general form of the imbedding by writing the line elements of,  $M^4$ ,  $S^2$ , and  $\text{AdS}_4$ .

1. The line element of  $M^4$  in spherical Minkowski coordinates  $(m, r_M, \theta, \phi)$  reads as

$$ds^2 = dm^2 - dr_M^2 - r_M^2 d\Omega^2 . \quad (3.7.2)$$

2. Also the line element of  $S^2$  is familiar:

$$ds^2 = -R^2(d\Theta^2 + \sin^2(\theta)d\Phi^2) . \quad (3.7.3)$$

3. By visiting in Wikipedia one learns that in spherical coordinate the line element of  $\text{AdS}_4$  is given by

$$\begin{aligned} ds^2 &= A(r)dt^2 - \frac{1}{A(r)}dr^2 - r^2d\Omega^2 , \\ A(r) &= 1 + y^2 , \quad y = \frac{r}{r_0} . \end{aligned} \quad (3.7.4)$$

4. From these formulas it is easy to see that the ansatz is of the same general form as for the imbedding of Schwarzschild-Nordstöm metric:

$$\begin{aligned} m &= \Lambda t + h(y) , \quad r_M = r , \\ \Theta &= s(y) , \quad \Phi = \omega(t + f(y)) . \end{aligned} \quad (3.7.5)$$

The non-trivial conditions on the components of the induced metric are given by

$$\begin{aligned} g_{tt} &= \Lambda^2 - x^2 \sin^2(\Theta) = A(r) , \\ g_{tr} &= \frac{1}{r_0} \left[ \Lambda \frac{dh}{dy} - x^2 \sin^2(\theta) \frac{df}{dr} \right] = 0 , \\ g_{rr} &= \frac{1}{r_0^2} \left[ \left( \frac{dh}{dy} \right)^2 - 1 - x^2 \sin^2(\theta) \left( \frac{df}{dy} \right)^2 - R^2 \left( \frac{d\Theta}{dy} \right)^2 \right] = -\frac{1}{A(r)} , \\ x &= R\omega . \end{aligned} \quad (3.7.6)$$

By some simple algebraic manipulations one can derive expressions for  $\sin(\Theta)$ ,  $df/dr$  and  $dh/dr$ .

1. For  $\Theta(r)$  the equation for  $g_{tt}$  gives the expression

$$\begin{aligned} \sin(\Theta) &= \pm \frac{P^{1/2}}{x} , \\ P &= \Lambda^2 - A = \Lambda^2 - 1 - y^2 . \end{aligned} \tag{3.7.7}$$

The condition  $0 \leq \sin^2(\Theta) \leq 1$  gives the conditions

$$(\Lambda^2 - x^2 - 1)^{1/2} \leq y \leq (\Lambda^2 - 1)^{1/2} . \tag{3.7.8}$$

Clearly only a spherical shell is possible.

2. From the vanishing of  $g_{tr}$  one obtains

$$\frac{dh}{dy} = \frac{P}{\Lambda} \frac{df}{dy} , \tag{3.7.9}$$

3. The condition for  $g_{rr}$  gives

$$\left(\frac{df}{dy}\right)^2 = \text{frac} r_0^2 AP [A^{-1} - R^2 \left(\frac{d\Theta}{dy}\right)^2] . \tag{3.7.10}$$

Clearly, the right-hand side is positive if  $P \geq 0$  holds true and  $Rd\Theta/dy$  is small. From this condition one can solve by expressing  $d\Theta/dy$  using chain rule as

$$\left(\frac{d\Theta}{dy}\right)^2 = \frac{x^2 y^2}{P(P-x^2)} . \tag{3.7.11}$$

One obtains

$$\left(\frac{df}{dy}\right)^2 = \Lambda r_0^2 \frac{y^2}{AP} \left[ \frac{1}{1+y^2} - x^2 \left(\frac{R}{r_0}\right)^2 \frac{1}{P(P-x^2)} \right] . \tag{3.7.12}$$

The right hand side of this equation is non-negative for certain range of parameters and variable  $y$ . Note that for  $r_0 \gg R$  the second term on the right hand side can be neglected. In this case it is easy to integrate  $f(y)$ .

The conclusion is that AdS<sub>4</sub> allows a local imbedding as a vacuum extremal. Whether also an imbedding as a non-vacuum preferred extremal to homologically non-trivial geodesic sphere is possible, is an interesting question.

### 3.7.3 Generalizing Ricci flow to Maxwell flow for 4-geometries and Kähler flow for space-time surfaces

The notion of Ricci flow has played a key part in the geometrization of topological invariants of Riemann manifolds. I certainly did not have this in mind when I choose to call my unification attempt "Topological Geometro-dynamics" but this title strongly suggests that a suitable generalization of Ricci flow could play a key role in the understanding of also TGD.

**Ricci flow and Maxwell flow for 4-geometries**

The observation about constancy of 4-D curvature scalar for preferred extremals inspires a generalization of the well-known volume preserving Ricci flow [?] introduced by Richard Hamilton. Ricci flow is defined in the space of Riemann metrics as

$$\frac{dg_{\alpha\beta}}{dt} = -2R_{\alpha\beta} + 2\frac{R_{avg}}{D}g_{\alpha\beta} . \tag{3.7.13}$$

Here  $R_{avg}$  denotes the average of the scalar curvature, and  $D$  is the dimension of the Riemann manifold. The flow is volume preserving in average sense as one easily checks ( $\langle g^{\alpha\beta} dg_{\alpha\beta}/dt \rangle = 0$ ). The volume preserving property of this flow allows to intuitively understand that the volume of a 3-manifold in the asymptotic metric defined by the Ricci flow is topological invariant. The fixed points of the flow serve as canonical representatives for the topological equivalence classes of 3-manifolds. These 3-manifolds (for instance hyperbolic 3-manifolds with constant sectional curvatures) are highly symmetric. This is easy to understand since the flow is dissipative and destroys all details from the metric.

What happens in the recent case? The first thing to do is to consider what might be called Maxwell flow in the space of all 4-D Riemann manifolds allowing Maxwell field.

1. First of all, the vanishing of the trace of Maxwell's energy momentum tensor codes for the volume preserving character of the flow defined as

$$\frac{dg_{\alpha\beta}}{dt} = T_{\alpha\beta} . \tag{3.7.14}$$

Taking covariant divergence on both sides and assuming that  $d/dt$  and  $D_\alpha$  commute, one obtains that  $T^{\alpha\beta}$  is divergenceless.

This is true if one assumes Einstein's equations with cosmological term. This gives

$$\frac{dg_{\alpha\beta}}{dt} = kG_{\alpha\beta} + \Lambda g_{\alpha\beta} = kR_{\alpha\beta} + \left(-\frac{kR}{2} + \Lambda\right)g_{\alpha\beta} . \tag{3.7.15}$$

The trace of this equation gives that the curvature scalar is constant. Note that the value of the Kähler coupling strength plays a highly non-trivial role in these equations and it is quite possible that solutions exist only for some critical values of  $\alpha_K$ . Quantum criticality should fix the allow value triplets  $(G, \Lambda, \alpha_K)$  apart from overall scaling

$$(G, \Lambda, \alpha_K) \rightarrow (xG, \Lambda/x, x\alpha_K) .$$

Fixing the value of  $G$  fixes the values remaining parameters at critical points. The rescaling of the parameter  $t$  induces a scaling by  $x$ .

2. By taking trace one obtains the already mentioned condition fixing the curvature to be constant, and one can write

$$\frac{dg_{\alpha\beta}}{dt} = kR_{\alpha\beta} - \Lambda g_{\alpha\beta} . \tag{3.7.16}$$

Note that in the recent case  $R_{avg} = R$  holds true since curvature scalar is constant. The fixed points of the flow would be Einstein manifolds [?, ?] satisfying

$$R_{\alpha\beta} = \frac{\Lambda}{k}g_{\alpha\beta} \tag{3.7.17}$$

3. It is by no means obvious that continuous flow is possible. The condition that Einstein-Maxwell equations are satisfied might pick up from a completely general Maxwell flow a discrete subset as solutions of Einstein-Maxwell equations with a cosmological term. If so, one could assign to this subset a sequence of values  $t_n$  of the flow parameter  $t$ .
4. I do not know whether 3-dimensionality is somehow absolutely essential for getting the topological classification of closed 3-manifolds using Ricci flow. This ignorance allows me to pose some innocent questions. Could one have a canonical representation of 4-geometries as spaces with constant Ricci scalar? Could one select one particular Einstein space in the class four-metrics and could the ratio  $\Lambda/k$  represent topological invariant if one normalizes metric or curvature scalar suitably. In the 3-dimensional case curvature scalar is normalized to unity. In the recent case this normalization would give  $k = 4\Lambda$  in turn giving  $R_{\alpha\beta} = g_{\alpha\beta}/4$ . Does this mean that there is only single fixed point in local sense, analogous to black hole toward which all geometries are driven by the Maxwell flow? Does this imply that only the 4-volume of the original space would serve as a topological invariant?

### Maxwell flow for space-time surfaces

One can consider Maxwell flow for space-time surfaces too. In this case Kähler flow would be the appropriate term and provides families of preferred extremals. Since space-time surfaces inside CD are the basic physical objects are in TGD framework, a possible interpretation of these families would be as flows describing physical dissipation as a four-dimensional phenomenon polishing details from the space-time surface interpreted as an analog of Bohr orbit.

1. The flow is now induced by a vector field  $j^k(x, t)$  of the space-time surface having values in the tangent bundle of imbedding space  $M^4 \times CP_2$ . In the most general case one has Kähler flow without the Einstein equations. This flow would be defined in the space of all space-time surfaces or possibly in the space of all extremals. The flow equations reduce to

$$h_{kl}D_\alpha j^k(x, t)D_\beta h^l = \frac{1}{2}T_{\alpha\beta} . \quad (3.7.18)$$

The left hand side is the projection of the covariant gradient  $D_\alpha j^k(x, t)$  of the flow vector field  $j^k(x, t)$  to the tangent space of the space-time surface.  $D_{alpha}$  is covariant derivative taking into account that  $j^k$  is imbedding space vector field. For a fixed point space-time surface this projection must vanish assuming that this space-time surface reachable. A good guess for the asymptotia is that the divergence of Maxwell energy momentum tensor vanishes and that Einstein's equations with cosmological constant are well-defined.

Asymptotes corresponds to vacuum extremals. In Euclidian regions  $CP_2$  type vacuum extremals and in Minkowskian regions to any space-time surface in any 6-D sub-manifold  $M^4 \times Y^2$ , where  $Y^2$  is Lagrangian sub-manifold of  $CP_2$  having therefore vanishing induced Kähler form. Symplectic transformations of  $CP_2$  combined with diffeomorphisms of  $M^4$  give new Lagrangian manifolds. One would expect that vacuum extremals are approached but never reached at second extreme for the flow.

If one assumes Einstein's equations with a cosmological term, allowed vacuum extremals must be Einstein manifolds. For  $CP_2$  type vacuum extremals this is the case. It is quite possible that these fixed points do not actually exist in Minkowskian sector, and could be replaced with more complex asymptotic behavior such as limit, chaos, or strange attractor.

2. The flow could be also restricted to the space of preferred extremals. Assuming that Einstein Maxwell equations indeed hold true, the flow equations reduce to

$$h_{kl}D_\alpha j^k(x, t)\partial_\beta h^l = \frac{1}{2}(kR_{\alpha\beta} - \Lambda g_{\alpha\beta}) . \quad (3.7.19)$$

Preferred extremals would correspond to a fixed sub-manifold of the general flow in the space of all 4-surfaces.

3. One can also consider a situation in which  $j^k(x, t)$  is replaced with  $j^k(h, t)$  defining a flow in the entire imbedding space. This assumption is probably too restrictive. In this case the equations reduce to

$$(D_r j_l(x, t) + D_l j_r) \partial_\alpha h^r \partial_\beta h^l = k R_{\alpha\beta} - \Lambda g_{\alpha\beta} . \quad (3.7.20)$$

Here  $D_r$  denotes covariant derivative. Asymptotia is achieved if the tensor  $D_k j_l + D_l j_k$  becomes orthogonal to the space-time surface. Note for that Killing vector fields of  $H$  the left hand side vanishes identically. Killing vector fields are indeed symmetries of also asymptotic states.

It must be made clear that the existence of a continuous flow in the space of preferred extremals might be too strong a condition. Already the restriction of the general Maxwell flow in the space of metrics to solutions of Einstein-Maxwell equations with cosmological term might lead to discretization, and the assumption about repretability as 4-surface in  $M^4 \times CP_2$  would give a further condition reducing the number of solutions. On the other hand, one might consider a possibility of a continuous flow in the space of constant Ricci scalar metrics with a fixed 4-volume and having hyperbolic spaces as the most symmetric representative.

### Dissipation, self organization, transition to chaos, and coupling constant evolution

A beautiful connection with concepts like dissipation, self-organization, transition to chaos, and coupling constant evolution suggests itself.

1. It is not at all clear whether the vacuum extremal limits of the preferred extremals can correspond to Einstein spaces except in special cases such as  $CP_2$  type vacuum extremals isometric with  $CP_2$ . The imbeddability condition however defines a constraint force which might well force asymptotically more complex situations such as limit cycles and strange attractors. In ordinary dissipative dynamics an external energy feed is essential prerequisite for this kind of non-trivial self-organization patterns.

In the recent case the external energy feed could be replaced by the constraint forces due to the imbeddability condition. It is not too difficult to imagine that the flow (if it exists!) could define something analogous to a transition to chaos taking place in a stepwise manner for critical values of the parameter  $t$ . Alternatively, these discrete values could correspond to those values of  $t$  for which the preferred extremal property holds true for a general Maxwell flow in the space of 4-metrics. Therefore the preferred extremals of Kähler action could emerge as one-parameter (possibly discrete) families describing dissipation and self-organization at the level of space-time dynamics.

2. For instance, one can consider the possibility that in some situations Einstein's equations split into two mutually consistent equations of which only the first one is independent

$$\begin{aligned} x J^\alpha{}_\nu J^{\nu\beta} &= R^{\alpha\beta} , \\ L_K &= x J^\alpha{}_\nu J^{\nu\beta} = 4\Lambda , \\ x &= \frac{1}{16\pi\alpha_K} . \end{aligned} \quad (3.7.21)$$

Note that the first equation indeed gives the second one by tracing. This happens for  $CP_2$  type vacuum extremals.

Kähler action density would reduce to cosmological constant which should have a continuous spectrum if this happens always. A more plausible alternative is that this holds true only asymptotically. In this case the flow equation could not lead arbitrary near to vacuum extremal, and one can think of situation in which  $L_K = 4\Lambda$  defines an analog of limiting cycle or perhaps even strange attractor. In any case, the assumption would allow to deduce the asymptotic value



of the action density which is of utmost importance from calculational point of view: action would be simply  $S_K = 4\Lambda V_4$  and one could also say that one has minimal surface with  $\Lambda$  taking the role of string tension.

3. One of the key ideas of TGD is quantum criticality implying that Kähler coupling strength is analogous to critical temperature. Second key idea is that p-adic coupling constant evolution represents discretized version of continuous coupling constant evolution so that each p-adic prime would correspond a fixed point of ordinary coupling constant evolution in the sense that the 4-volume characterized by the p-adic length scale remains constant. The invariance of the geometric and thus geometric parameters of hyperbolic 4-manifold under the Kähler flow would conform with the interpretation as a flow preserving scale assignable to a given p-adic prime. The continuous evolution in question (if possible at all!) might correspond to a fixed p-adic prime. Also the hierarchy of Planck constants relates to this picture naturally. Planck constant  $\hbar_{eff} = n\hbar$  corresponds to a multi-furcation generating n-sheeted structure and certainly affecting the fundamental group.
4. One can of course question the assumption that a continuous flow exists. The property of being a solution of Einstein-Maxwell equations, imbeddability property, and preferred extremal property might allow only discrete sequences of space-time surfaces perhaps interpretable as orbit of an iterated map leading gradually to a fractal limit. This kind of discrete sequence might be also be selected as preferred extremals from the orbit of Maxwell flow without assuming Einstein-Maxwell equations. Perhaps the discrete p-adic coupling constant evolution could be seen in this manner and be regarded as an iteration so that the connection with fractality would become obvious too.

**Does a 4-D counterpart of thermodynamics make sense?**

The interpretation of the Kähler flow in terms of dissipation, the constancy of  $R$ , and almost constancy of  $L_K$  suggest an interpretation in terms of 4-D variant of thermodynamics natural in zero energy ontology (ZEO), where physical states are analogs for pairs of initial and final states of quantum event are quantum superpositions of classical time evolutions. Quantum theory becomes a "square root" of thermodynamics so that 4-D analog of thermodynamics might even replace ordinary thermodynamics as a fundamental description. If so this 4-D thermodynamics should be qualitatively consistent with the ordinary 3-D thermodynamics.

1. The first naive guess would be the interpretation of the action density  $L_K$  as an analog of energy density  $e = E/V_3$  and that of  $R$  as the analog to entropy density  $s = S/V_3$ . The asymptotic states would be analogs of thermodynamical equilibria having constant values of  $L_K$  and  $R$ .
2. Apart from an overall sign factor  $\epsilon$  to be discussed, the analog of the first law  $de = Tds - pdV/V$  would be

$$dL_K = kdR + \Lambda \frac{dV_4}{V_4} .$$

One would have the correspondences  $S \rightarrow \epsilon RV_4$ ,  $e \rightarrow \epsilon L_K$  and  $k \rightarrow T$ ,  $p \rightarrow -\Lambda$ .  $k \propto 1/G$  indeed appears formally in the role of temperature in Einstein's action defining a formal partition function via its exponent. The analog of second law would state the increase of the magnitude of  $\epsilon RV_4$  during the Kähler flow.

3. One must be very careful with the signs and discuss Euclidian and Minkowskian regions separately. Concerning purely thermodynamic aspects at the level of vacuum functional Euclidian regions are those which matter.
  - (a) For  $CP_2$  type vacuum extremals  $L_K \propto E^2 + B^2$ ,  $R = \Lambda/k$ , and  $\Lambda$  are positive. In thermodynamical analogy for  $\epsilon = 1$  this would mean that pressure is negative.
  - (b) In Minkowskian regions the value of  $R = \Lambda/k$  is negative for  $\Lambda < 0$  suggested by the large abundance of 4-manifolds allowing hyperbolic metric and also by cosmological considerations. The asymptotic formula  $L_K = 4\Lambda$  considered above suggests that also Kähler action

is negative in Minkowskian regions for magnetic flux tubes dominating in TGD inspired cosmology: the reason is that the magnetic contribution to the action density  $L_K \propto E^2 - B^2$  dominates.

Consider now in more detail the 4-D thermodynamics interpretation in Euclidian and Minkowskian regions assuming that the evolution by quantum jumps has Kähler flow as a space-time correlate.

1. In Euclidian regions the choice  $\epsilon = 1$  seems to be more reasonable one. In Euclidian regions  $-\Lambda$  as the analog of pressure would be negative, and asymptotically (that is for  $CP_2$  type vacuum extremals) its value would be proportional to  $\Lambda \propto 1/GR^2$ , where  $R$  denotes  $CP_2$  radius defined by the length of its geodesic circle.

A possible interpretation for negative pressure is in terms of string tension effectively inducing negative pressure (note that the solutions of the modified Dirac equation indeed assign a string to the wormhole contact). The analog of the second law would require the increase of  $RV_4$  in quantum jumps. The magnitudes of  $L_K$ ,  $R$ ,  $V_4$  and  $\Lambda$  would be reduced and approach their asymptotic values. In particular,  $V_4$  would approach asymptotically the volume of  $CP_2$ .

2. In Minkowskian regions Kähler action contributes to the vacuum functional a phase factor analogous to an imaginary exponent of action serving in the role of Morse function so that thermodynamics interpretation can be questioned. Despite this one can check whether thermodynamic interpretation can be considered. The choice  $\epsilon = -1$  seems to be the correct choice now.  $-\Lambda$  would be analogous to a negative pressure whose gradually decreases. In 3-D thermodynamics it is natural to assign negative pressure to the magnetic flux tube like structures as their effective string tension defined by the density of magnetic energy per unit length.  $-R \geq 0$  would entropy and  $-L_K \geq 0$  would be the analog of energy density.

$R = \Lambda/k$  and the reduction of  $\Lambda$  during cosmic evolution by quantum jumps suggests that the larger the volume of CD and thus of (at least) Minkowskian space-time sheet the smaller the negative value of  $\Lambda$ .

Assume the recent view about state function reduction explaining how the arrow of geometric time is induced by the quantum jump sequence defining experienced time [?]. According to this view zero energy states are quantum superpositions over  $CD$ s of various size scales but with common tip, which can correspond to either the upper or lower light-like boundary of  $CD$ . The sequence of quantum jumps the gradual increase of the average size of  $CD$  in the quantum superposition and therefore that of average value of  $V_4$ . On the other hand, a gradual decrease of both  $-L_K$  and  $-R$  looks physically very natural. If Kähler flow describes the effect of dissipation by quantum jumps in ZEO then the space-time surfaces would gradually approach nearly vacuum extremals with constant value of entropy density  $-R$  but gradually increasing 4-volume so that the analog of second law stating the increase of  $-RV_4$  would hold true.

3. The interpretation of  $-R > 0$  as negentropy density assignable to entanglement is also possible and is consistent with the interpretation in terms of second law. This interpretation would only change the sign factor  $\epsilon$  in the proposed formula. Otherwise the above arguments would remain as such.

### 3.7.4 Could correlation functions, S-matrix, and coupling constant evolution be coded the statistical properties of preferred extremals?

Quantum classical correspondence states that all aspects of quantum states should have correlates in the geometry of preferred extremals. In particular, various elementary particle propagators should have a representation as properties of preferred extremals. This would allow to realize the old dream about being able to say something interesting about coupling constant evolution although it is not yet possible to calculate the M-matrices and U-matrix. Hitherto everything that has been said about coupling constant evolution has been rather speculative arguments except for the general vision that it reduces to a discrete evolution defined by p-adic length scales. General first principle definitions are however much more valuable than ad hoc guesses even if the latter give rise to explicit formulas.

In quantum TGD and also at its QFT limit various correlation functions in given quantum state should code for its properties. By quantum classical correspondence these correlation functions should

have counterparts in the geometry of preferred extremals. Even more: these classical counterparts for a given preferred extremal ought to be identical with the quantum correlation functions for the superposition of preferred extremals. This correspondence could be called quantum ergodicity by its analogy with ordinary ergodicity stating that the member of ensemble becomes representative of ensemble.

1. The marvelous implication of quantum ergodicity would be that one could calculate everything solely classically using the classical intuition - the only intuition that we have. Quantum ergodicity would also solve the paradox raised by the quantum classical correspondence for momentum eigenstates. Any preferred extremal in their superposition defining momentum eigenstate should code for the momentum characterizing the superposition itself. This is indeed possible if every extremal in the superposition codes the momentum to the properties of classical correlation functions which are identical for all of them.
2. The only manner to possibly achieve quantum ergodicity is in terms of the statistical properties of the preferred extremals. It should be possible to generalize the ergodic theorem stating that the properties of statistical ensemble are represented by single space-time evolution in the ensemble of time evolutions. Quantum superposition of classical worlds would effectively reduce to single classical world as far as classical correlation functions are considered. The notion of finite measurement resolution suggests that one must state this more precisely by adding that classical correlation functions are calculated in a given UV and IR resolutions meaning UV cutoff defined by the smallest CD and IR cutoff defined by the largest CD present.
3. The skeptic inside me immediately argues that TGD Universe is 4-D spin glass so that this quantum ergodic theorem must be broken. In the case of the ordinary spin glasses one has not only statistical average for a fixed Hamiltonian but a statistical average over Hamiltonians. There is a probability distribution over the coupling parameters appearing in the Hamiltonian. Maybe the quantum counterpart of this is needed to predict the physically measurable correlation functions.

Could this average be an ordinary classical statistical average over quantum states with different classical correlation functions? This kind of average is indeed taken in density matrix formalism. Or could it be that the square root of thermodynamics defined by ZEO actually gives automatically rise to this average? The eigenvalues of the "hermitian square root" of the density matrix would code for components of the state characterized by different classical correlation functions. One could assign these contributions to different "phases".

4. Quantum classical correspondence in statistical sense would be very much like holography (now individual classical state represents the entire quantum state). Quantum ergodicity would pose a rather strong constraint on quantum states. This symmetry principle could actually fix the spectrum of zero energy states to a high degree and fix therefore the M-matrices given by the product of hermitian square root of density matrix and unitary S-matrix and unitary U-matrix having M-matrices as its orthonormal rows.
5. In TGD inspired theory of consciousness the counterpart of quantum ergodicity is the postulate that the space-time geometry provides a symbolic representation for the quantum states and also for the contents of consciousness assignable to quantum jumps between quantum states. Quantum ergodicity would realize this strongly self-referential looking condition. The positive and negative energy parts of zero energy state would be analogous to the initial and final states of quantum jump and the classical correlation functions would code for the contents of consciousness like written formulas code for the thoughts of mathematician and provide a sensory feedback.

How classical correlation functions should be defined?

1. General Coordinate Invariance and Lorentz invariance are the basic constraints on the definition. These are achieved for the space-time regions with Minkowskian signature and 4-D  $M^4$  projection if linear Minkowski coordinates are used. This is equivalent with the contraction of the indices of tensor fields with the space-time projections of  $M^4$  Killing vector fields representing translations.

Accepting this generalization, there is no need to restrict oneself to 4-D  $M^4$  projection and one can also consider also Euclidian regions identifiable as lines of generalized Feynman diagrams.

Quantum ergodicity very probably however forces to restrict the consideration to Minkowskian and Euclidian space-time regions and various phases associated with them. Also  $CP_2$  Killing vector fields can be projected to space-time surface and give a representation for classical gluon fields. These in turn can be contracted with  $M^4$  Killing vectors giving rise to gluon fields as analogs of graviton fields but with second polarization index replaced with color index.

2. The standard definition for the correlation functions associated with classical time evolution is the appropriate starting point. The correlation function  $G_{XY}(\tau)$  for two dynamical variables  $X(t)$  and  $Y(t)$  is defined as the average  $G_{XY}(\tau) = \int_T X(t)Y(t+\tau)dt/T$  over an interval of length  $T$ , and one can also consider the limit  $T \rightarrow \infty$ . In the recent case one would replace  $\tau$  with the difference  $m_1 - m_2 = m$  of  $M^4$  coordinates of two points at the preferred extremal and integrate over the points of the extremal to get the average. The finite time interval  $T$  is replaced with the volume of causal diamond in a given length scale. Zero energy state with given quantum numbers for positive and negative energy parts of the state defines the initial and final states between which the fields appearing in the correlation functions are defined.
3. What correlation functions should be considered? Certainly one could calculate correlation functions for the induced spinor connection given electro-weak propagators and correlation functions for  $CP_2$  Killing vector fields giving correlation functions for gluon fields using the description in terms of Killing vector fields. If one can uniquely separate from the Fourier transform uniquely a term of form  $Z/(p^2 - m^2)$  by its momentum dependence, the coefficient  $Z$  can be identified as coupling constant squared for the corresponding gauge potential component and one can in principle deduce coupling constant evolution purely classically. One can imagine of calculating spinorial propagators for string world sheets in the same manner. Note that also the dependence on color quantum numbers would be present so that in principle all that is needed could be calculated for a single preferred extremal without the need to construct QFT limit and to introduce color quantum numbers of fermions as spin like quantum numbers (color quantum numbers corresponds to  $CP_2$  partial wave for the tip of the CD assigned with the particle).
4. What about Higgs field? TGD in principle allows scalar and pseudo-scalars which could be called Higgs like states. These states are however not necessary for particle massivation although they can represent particle massivation and must do so if one assumes that QFT limit exist. p-Adic thermodynamics however describes particle massivation microscopically.

The problem is that Higgs like field does not seem to have any obvious space-time correlate. The trace of the second fundamental form is the obvious candidate but vanishes for preferred extremals which are both minimal surfaces and solutions of Einstein Maxwell equations with cosmological constant. If the string world sheets at which all spinor components except right handed neutrino are localized for the general solution ansatz of the modified Dirac equation, the corresponding second fundamental form at the level of imbedding space defines a candidate for classical Higgs field. A natural expectation is that string world sheets are minimal surfaces of space-time surface. In general they are however not minimal surfaces of the imbedding space so that one might achieve a microscopic definition of classical Higgs field and its vacuum expectation value as an average of one point correlation function over the string world sheet.

Many detailed speculations about coupling constant evolution to be discussed in the sections below must be taken as innovative guesses doomed to have the eventual fate of guesses. The notion of quantum ergodicity could however be one of the really deep ideas about coupling constant evolution comparable to the notion of p-adic coupling constant evolution. Quantum Ergodicity (briefly QE) would also state something extremely non-trivial also about the construction of correlation functions and S-matrix. Because this principle is so new, the rest of the chapter does not yet contain any applications of QE. This should not lead the reader to under-estimate the potential power of QE.

### 3.8 Appendix: Hamilton-Jacobi structure

In the following the definition of Hamilton-Jacobi structure is discussed in detail.

### 3.8.1 Hermitian and hyper-Hermitian structures

The starting point is the observation that besides the complex numbers forming a number field there are hyper-complex numbers. Imaginary unit  $i$  is replaced with  $e$  satisfying  $e^2 = 1$ . One obtains an algebra but not a number field since the norm is Minkowskian norm  $x^2 - y^2$ , which vanishes at light-cone  $x = y$  so that light-like hypercomplex numbers  $x \pm e$  do not have inverse. One has "almost" number field.

Hyper-complex numbers appear naturally in 2-D Minkowski space since the solutions of a massless field equation can be written as  $f = g(u = t - ex) + h(v = t + ex)$  which  $e^2 = 1$  realized by putting  $e = 1$ . Therefore Wick rotation relates sums of holomorphic and antiholomorphic functions to sums of hyper-holomorphic and anti-hyper-holomorphic functions. Note that  $u$  and  $v$  are hyper-complex conjugates of each other.

Complex  $n$ -dimensional spaces allow Hermitian structure. This means that the metric has in complex coordinates  $(z_1, \dots, z_n)$  the form in which the matrix elements of metric are nonvanishing only between  $z_i$  and complex conjugate of  $z_j$ . In 2-D case one obtains just  $ds^2 = g_{z\bar{z}} dz d\bar{z}$ . Note that in this case metric is conformally flat since line element is proportional to the line element  $ds^2 = dz d\bar{z}$  of plane. This form is always possible locally. For complex  $n$ -D case one obtains  $ds^2 = g_{i\bar{j}} dz^i d\bar{z}^j$ .  $g_{i\bar{j}} = \overline{g_{j\bar{i}}}$  guaranteeing the reality of  $ds^2$ . In 2-D case this condition gives  $g_{z\bar{z}} = \overline{g_{z\bar{z}}}$ .

How could one generalize this line element to hyper-complex  $n$ -dimensional case. In 2-D case Minkowski space  $M^2$  one has  $ds^2 = g_{uv} du dv$ ,  $g_{uv} = 1$ . The obvious generalization would be the replacement  $ds^2 = g_{u_i v_j} du^i dv^j$ . Also now the analogs of reality conditions must hold with respect to  $u_i \leftrightarrow v_i$ .

### 3.8.2 Hamilton-Jacobi structure

Consider next the path leading to Hamilton-Jacobi structure.

4-D Minkowski space  $M^4 = M^2 \times E^2$  is Cartesian product of hyper-complex  $M^2$  with complex plane  $E^2$ , and one has  $ds^2 = dudv + dzd\bar{z}$  in standard Minkowski coordinates. One can also consider more general integrable decompositions of  $M^4$  for which the tangent space  $TM^4 = M^4$  at each point is decomposed to  $M^2(x) \times E^2(x)$ . The physical analogy would be a position dependent decomposition of the degrees of freedom of massless particle to longitudinal ones ( $M^2(x)$ : light-like momentum is in this plane) and transversal ones ( $E^2(x)$ : polarization vector is in this plane). Cylindrical and spherical variants of Minkowski coordinates define two examples of this kind of coordinates (it is perhaps a good exercise to think what kind of decomposition of tangent space is in question in these examples). An interesting mathematical problem highly relevant for TGD is to identify all possible decompositions of this kind for empty Minkowski space.

The integrability of the decomposition means that the planes  $M^2(x)$  are tangent planes for 2-D surfaces of  $M^4$  analogous to Euclidian string world sheet. This gives slicing of  $M^4$  to Minkowskian string world sheets parametrized by euclidian string world sheets. The question is whether the sheets are stringy in a strong sense: that is minimal surfaces. This is not the case: for spherical coordinates the Euclidian string world sheets would be spheres which are not minimal surfaces. For cylindrical and spherical coordinates however  $M^2(x)$  integrate to plane  $M^2$  which is minimal surface.

Integrability means in the case of  $M^2(x)$  the existence of light-like vector field  $J$  whose flow lines define a global coordinate. Its existence implies also the existence of its conjugate and together these vector fields give rise to  $M^2(x)$  at each point. This means that one has  $J = \Psi \nabla \Phi$ :  $\Phi$  indeed defines the global coordinate along flow lines. In the case of  $M^2$  either the coordinate  $u$  or  $v$  would be the coordinate in question. This kind of flows are called Beltrami flows. Obviously the same holds for the transversal planes  $E^2$ .

One can generalize this metric to the case of general 4-D space with Minkowski signature of metric. At least the elements  $g_{uv}$  and  $g_{z\bar{z}}$  are non-vanishing and can depend on both  $u, v$  and  $z, \bar{z}$ . They must satisfy the reality conditions  $g_{z\bar{z}} = \overline{g_{z\bar{z}}}$  and  $g_{uv} = \overline{g_{vu}}$  where complex conjugation in the argument involves also  $u \leftrightarrow v$  besides  $z \leftrightarrow \bar{z}$ .

The question is whether the components  $g_{uz}, g_{vz}$ , and their complex conjugates are non-vanishing if they satisfy some conditions. They can. The direct generalization from complex 2-D space would be that one treats  $u$  and  $v$  as complex conjugates and therefore requires a direct generalization of the hermiticity condition

$$g_{uz} = \overline{g_{v\bar{z}}} \ , \ g_{vz} = \overline{g_{u\bar{z}}} \ .$$

This would give complete symmetry with the complex 2-D (4-D in real sense) spaces. This would allow the algebraic continuation of hermitian structures to Hamilton-Jacobi structures by just replacing  $i$  with  $e$  for some complex coordinates.

# Mathematics

- [A1] Gaussian Mersenne. <http://primes.utm.edu/glossary/xpage/GaussianMersenne.html>.
- [A2] Z. I. Borevich and I. R. Shafarevich. *Number Theory*. Academic Press, 1966.
- [A3] Eisenhart. *Riemannian Geometry*. Princeton University Press, 1964.
- [A4] C. N. Pope G. W. Gibbons.  $CP_2$  as gravitational instanton. *Comm. Math. Phys.*, 55, 1977.
- [A5] W. Hawking, S. and N. Pope, C. Generalized Spin Structures in Quantum Gravity. *Phys. Lett.*, (1), 1978.
- [A6] S. Helgason. *Differential Geometry and Symmetric Spaces*. Academic Press, New York, 1962.
- [A7] C. Itzykson and J-B. Zuber. *Quantum Field Theory*, volume 549. Mc Graw-Hill, New York, 1980.
- [A8] J. Milnor. *Topology form Differential Point of View*. The University Press of Virginia, Virginia, 1965.
- [A9] D. S. Moak. The q-analogue of the Laguerre polynomials. *J. Math. Anal. Appl.*, 81, 1981.
- [A10] N. Pope, C. Eigenfunctions and  $Spin^c$  Structures on  $CP_2$ , 1980.
- [A11] B. Shipman. The geometry of momentum mappings on generalized flag manifolds, connections with a dynamical system, quantum mechanics and the dance of honeybee. <http://math.cornell.edu/~oliver/Shipman.gif>, 1998.
- [A12] M. Spivak. *Differential Geometry I,II,III,IV*. Publish or Perish, Boston, 1970.
- [A13] J. Hanson T. Eguchi, B. Gilkey. *Phys. Rep.*, 66:1980, 1980.
- [A14] R. Thom. *Commentarii Math. Helvet.*, 28, 1954.
- [A15] Wallace. *Differential Topology*. W. A. Benjamin, New York, 1968.
- [A16] E. C. Zeeman. *Catastrophe Theory*. Addison-Wessley Publishing Company, 1977.





# Theoretical Physics

- [B1] J. Björken and S. Drell. *Relativistic Quantum Fields*. Mc Graw-Hill, New York, 1965.
- [B2] K. Huang. *Quarks, Leptons & Gauge Fields*. World Scientific, 1982.
- [B3] R. Kiehn. Electromagnetic waves in vacuum with torsion and spin. <http://www22.pair.com/csdc/pdf/helical6.pdf>.
- [B4] G. Parisi. *Field Theory, Disorder and Simulations*. World Scientific, 1992.
- [B5] A. Zee. *The Unity of Forces in the Universe*. World Science Press, Singapore, 1982.



# Books related to TGD

- [K1] M. Pitkänen. 1983.
- [K2] M. Pitkänen. Is it Possible to Understand Coupling Constant Evolution at Space-Time Level? In *Towards M-Matrix*. Onlinebook. [http://tgdtheory.com/public\\_html/tgdquant/tgdquant.html#rgflow](http://tgdtheory.com/public_html/tgdquant/tgdquant.html#rgflow), 2006.
- [K3] M. Pitkänen. About Strange Effects Related to Rotating Magnetic Systems . In *TGD and Fringe Physics*. Onlinebook. [http://tgdtheory.com/public\\_html/freenergy/freenergy.html#Faraday](http://tgdtheory.com/public_html/freenergy/freenergy.html#Faraday), 2006.
- [K4] M. Pitkänen. About the New Physics Behind Qualia. In *Quantum Hardware of Living Matter*. Onlinebook. [http://tgdtheory.com/public\\_html/bioware/bioware.html#newphys](http://tgdtheory.com/public_html/bioware/bioware.html#newphys), 2006.
- [K5] M. Pitkänen. An Overview about Quantum TGD: Part I. In *Topological Geometrodynamics: Overview*. Onlinebook. [http://tgdtheory.com/public\\_html/tgdview/tgdview.html#evoII](http://tgdtheory.com/public_html/tgdview/tgdview.html#evoII), 2006.
- [K6] M. Pitkänen. An Overview about the Evolution of Quantum TGD. In *Topological Geometrodynamics: Overview*. Onlinebook. [http://tgdtheory.com/public\\_html/tgdview/tgdview.html#evoI](http://tgdtheory.com/public_html/tgdview/tgdview.html#evoI), 2006.
- [K7] M. Pitkänen. Anomalies Related to the Classical  $Z^0$  Force and Gravitation. In *TGD and Fringe Physics*. Onlinebook. [http://tgdtheory.com/public\\_html/freenergy/freenergy.html#Zanom](http://tgdtheory.com/public_html/freenergy/freenergy.html#Zanom), 2006.
- [K8] M. Pitkänen. Appendix A: Quantum Groups and Related Structures. In *Towards M-Matrix*. Onlinebook. [http://tgdtheory.com/public\\_html/tgdquant/tgdquant.html#bialgebra](http://tgdtheory.com/public_html/tgdquant/tgdquant.html#bialgebra), 2006.
- [K9] M. Pitkänen. Basic Extremals of Kähler Action. In *Physics in Many-Sheeted Space-Time*. Onlinebook. [http://tgdtheory.com/public\\_html/tgdclass/tgdclass.html#class](http://tgdtheory.com/public_html/tgdclass/tgdclass.html#class), 2006.
- [K10] M. Pitkänen. *Bio-Systems as Conscious Holograms*. Onlinebook. [http://tgdtheory.com/public\\_html/hologram/hologram.html](http://tgdtheory.com/public_html/hologram/hologram.html), 2006.
- [K11] M. Pitkänen. Bio-Systems as Conscious Holograms. In *Bio-Systems as Conscious Holograms*. Onlinebook. [http://tgdtheory.com/public\\_html/hologram/hologram.html#hologram](http://tgdtheory.com/public_html/hologram/hologram.html#hologram), 2006.
- [K12] M. Pitkänen. *Bio-Systems as Self-Organizing Quantum Systems*. Onlinebook. [http://tgdtheory.com/public\\_html/bioselforg/bioselforg.html](http://tgdtheory.com/public_html/bioselforg/bioselforg.html), 2006.
- [K13] M. Pitkänen. Bio-Systems as Super-Conductors: part I. In *Quantum Hardware of Living Matter*. Onlinebook. [http://tgdtheory.com/public\\_html/bioware/bioware.html#superc1](http://tgdtheory.com/public_html/bioware/bioware.html#superc1), 2006.
- [K14] M. Pitkänen. Bio-Systems as Super-Conductors: part II. In *Quantum Hardware of Living Matter*. Onlinebook. [http://tgdtheory.com/public\\_html/bioware/bioware.html#superc2](http://tgdtheory.com/public_html/bioware/bioware.html#superc2), 2006.
- [K15] M. Pitkänen. Configuration Space Spinor Structure. In *Quantum Physics as Infinite-Dimensional Geometry*. Onlinebook. [http://tgdtheory.com/public\\_html/tgdgeom/tgdgeom.html#cspin](http://tgdtheory.com/public_html/tgdgeom/tgdgeom.html#cspin), 2006.

- [K16] M. Pitkänen. Construction of elementary particle vacuum functionals. In *p-Adic Length Scale Hypothesis and Dark Matter Hierarchy*. Onlinebook. [http://tgdtheory.com/public\\_html/paddark/paddark.html#elvafu](http://tgdtheory.com/public_html/paddark/paddark.html#elvafu), 2006.
- [K17] M. Pitkänen. Construction of Quantum Theory: M-matrix. In *Towards M-Matrix*. Onlinebook. [http://tgdtheory.com/public\\_html/tgdquant/tgdquant.html#towards](http://tgdtheory.com/public_html/tgdquant/tgdquant.html#towards), 2006.
- [K18] M. Pitkänen. Cosmic Strings. In *Physics in Many-Sheeted Space-Time*. Onlinebook. [http://tgdtheory.com/public\\_html/tgdclass/tgdclass.html#cstrings](http://tgdtheory.com/public_html/tgdclass/tgdclass.html#cstrings), 2006.
- [K19] M. Pitkänen. Crop Circles and Life at Parallel Space-Time Sheets. In *Magnetospheric Consciousness*. Onlinebook. [http://tgdtheory.com/public\\_html/magnconsc/magnconsc.html#crop1](http://tgdtheory.com/public_html/magnconsc/magnconsc.html#crop1), 2006.
- [K20] M. Pitkänen. Crop Circles and Life at Parallel Space-Time Sheets. In *Magnetospheric Consciousness*. Onlinebook. [http://tgdtheory.com/public\\_html/magnconsc/magnconsc.html#crop2](http://tgdtheory.com/public_html/magnconsc/magnconsc.html#crop2), 2006.
- [K21] M. Pitkänen. Dark Forces and Living Matter. In *p-Adic Length Scale Hypothesis and Dark Matter Hierarchy*. Onlinebook. [http://tgdtheory.com/public\\_html/paddark/paddark.html#darkforces](http://tgdtheory.com/public_html/paddark/paddark.html#darkforces), 2006.
- [K22] M. Pitkänen. Dark Matter Hierarchy and Hierarchy of EEGs. In *TGD and EEG*. Onlinebook. [http://tgdtheory.com/public\\_html/tgdeeg/tgdeeg.html#eegdark](http://tgdtheory.com/public_html/tgdeeg/tgdeeg.html#eegdark), 2006.
- [K23] M. Pitkänen. Dark Nuclear Physics and Condensed Matter. In *p-Adic Length Scale Hypothesis and Dark Matter Hierarchy*. Onlinebook. [http://tgdtheory.com/public\\_html/paddark/paddark.html#exonuclear](http://tgdtheory.com/public_html/paddark/paddark.html#exonuclear), 2006.
- [K24] M. Pitkänen. DNA as Topological Quantum Computer. In *Genes and Memes*. Onlinebook. [http://tgdtheory.com/public\\_html/genememe/genememe.html#dnatqc](http://tgdtheory.com/public_html/genememe/genememe.html#dnatqc), 2006.
- [K25] M. Pitkänen. Does TGD Predict the Spectrum of Planck Constants? In *Towards M-Matrix*. Onlinebook. [http://tgdtheory.com/public\\_html/tgdquant/tgdquant.html#Planck](http://tgdtheory.com/public_html/tgdquant/tgdquant.html#Planck), 2006.
- [K26] M. Pitkänen. Evolution in Many-Sheeted Space-Time. In *Genes and Memes*. Onlinebook. [http://tgdtheory.com/public\\_html/genememe/genememe.html#prebio](http://tgdtheory.com/public_html/genememe/genememe.html#prebio), 2006.
- [K27] M. Pitkänen. General Ideas about Many-Sheeted Space-Time: Part I. In *Physics in Many-Sheeted Space-Time*. Onlinebook. [http://tgdtheory.com/public\\_html/tgdclass/tgdclass.html#topcond](http://tgdtheory.com/public_html/tgdclass/tgdclass.html#topcond), 2006.
- [K28] M. Pitkänen. General Theory of Qualia. In *Bio-Systems as Conscious Holograms*. Onlinebook. [http://tgdtheory.com/public\\_html/hologram/hologram.html#qualia](http://tgdtheory.com/public_html/hologram/hologram.html#qualia), 2006.
- [K29] M. Pitkänen. *Genes and Memes*. Onlinebook. [http://tgdtheory.com/public\\_html/genememe/genememe.html](http://tgdtheory.com/public_html/genememe/genememe.html), 2006.
- [K30] M. Pitkänen. Genes and Memes. In *Genes and Memes*. Onlinebook. [http://tgdtheory.com/public\\_html/genememe/genememe.html#genememec](http://tgdtheory.com/public_html/genememe/genememe.html#genememec), 2006.
- [K31] M. Pitkänen. Homeopathy in Many-Sheeted Space-Time. In *Bio-Systems as Conscious Holograms*. Onlinebook. [http://tgdtheory.com/public\\_html/hologram/hologram.html#homeoc](http://tgdtheory.com/public_html/hologram/hologram.html#homeoc), 2006.
- [K32] M. Pitkänen. Macro-Temporal Quantum Coherence and Spin Glass Degeneracy. In *Bio-Systems as Conscious Holograms*. Onlinebook. [http://tgdtheory.com/public\\_html/hologram/hologram.html#macro](http://tgdtheory.com/public_html/hologram/hologram.html#macro), 2006.
- [K33] M. Pitkänen. Macroscopic Quantum Coherence and Quantum Metabolism as Different Sides of the Same Coin. In *Bio-Systems as Conscious Holograms*. Onlinebook. [http://tgdtheory.com/public\\_html/hologram/hologram.html#metab](http://tgdtheory.com/public_html/hologram/hologram.html#metab), 2006.

- [K34] M. Pitkänen. Macroscopic Quantum Phenomena and  $CP_2$  Geometry. In *Physics in Many-Sheeted Space-Time*. Onlinebook. [http://tgdtheory.com/public\\_html/tgdclass/tgdclass.html#super](http://tgdtheory.com/public_html/tgdclass/tgdclass.html#super), 2006.
- [K35] M. Pitkänen. Magnetic Sensory Canvas Hypothesis. In *TGD and EEG*. Onlinebook. [http://tgdtheory.com/public\\_html//tgdeeg/tgdeeg/tgdeeg.html#mec](http://tgdtheory.com/public_html//tgdeeg/tgdeeg/tgdeeg.html#mec), 2006.
- [K36] M. Pitkänen. *Magnetospheric Consciousness*. Onlinebook. [http://tgdtheory.com/public\\_html/magnconsc/magnconsc.html](http://tgdtheory.com/public_html/magnconsc/magnconsc.html), 2006.
- [K37] M. Pitkänen. Magnetospheric Sensory Representations. In *Magnetospheric Consciousness*. Onlinebook. [http://tgdtheory.com/public\\_html/magnconsc/magnconsc.html#srepress](http://tgdtheory.com/public_html/magnconsc/magnconsc.html#srepress), 2006.
- [K38] M. Pitkänen. Many-Sheeted DNA. In *Genes and Memes*. Onlinebook. [http://tgdtheory.com/public\\_html/genememe/genememe.html#genecodec](http://tgdtheory.com/public_html/genememe/genememe.html#genecodec), 2006.
- [K39] M. Pitkänen. Massless states and particle massivation. In *p-Adic Length Scale Hypothesis and Dark Matter Hierarchy*. Onlinebook. [http://tgdtheory.com/public\\_html/paddark/paddark.html#mless](http://tgdtheory.com/public_html/paddark/paddark.html#mless), 2006.
- [K40] M. Pitkänen. *Mathematical Aspects of Consciousness Theory*. Onlinebook. [http://tgdtheory.com/public\\_html/mathconsc/mathconsc.html](http://tgdtheory.com/public_html/mathconsc/mathconsc.html), 2006.
- [K41] M. Pitkänen. Matter, Mind, Quantum. In *TGD Inspired Theory of Consciousness*. Onlinebook. [http://tgdtheory.com/public\\_html/tgdconsc/tgdconsc.html#conscic](http://tgdtheory.com/public_html/tgdconsc/tgdconsc.html#conscic), 2006.
- [K42] M. Pitkänen. Negentropy Maximization Principle. In *TGD Inspired Theory of Consciousness*. Onlinebook. [http://tgdtheory.com/public\\_html/tgdconsc/tgdconsc.html#nmpc](http://tgdtheory.com/public_html/tgdconsc/tgdconsc.html#nmpc), 2006.
- [K43] M. Pitkänen. New Particle Physics Predicted by TGD: Part I. In *p-Adic Length Scale Hypothesis and Dark Matter Hierarchy*. Onlinebook. [http://tgdtheory.com/public\\_html/paddark/paddark.html#mass4](http://tgdtheory.com/public_html/paddark/paddark.html#mass4), 2006.
- [K44] M. Pitkänen. Nuclear String Hypothesis. In *p-Adic Length Scale Hypothesis and Dark Matter Hierarchy*. Onlinebook. [http://tgdtheory.com/public\\_html/paddark/paddark.html#nuclstring](http://tgdtheory.com/public_html/paddark/paddark.html#nuclstring), 2006.
- [K45] M. Pitkänen. *p-Adic length Scale Hypothesis and Dark Matter Hierarchy*. Onlinebook. [http://tgdtheory.com/public\\_html/paddark/paddark.html](http://tgdtheory.com/public_html/paddark/paddark.html), 2006.
- [K46] M. Pitkänen. p-Adic Particle Massivation: Hadron Masses. In *p-Adic Length Scale Hypothesis and Dark Matter Hierarchy*. Onlinebook. [http://tgdtheory.com/public\\_html/paddark/paddark.html#mass3](http://tgdtheory.com/public_html/paddark/paddark.html#mass3), 2006.
- [K47] M. Pitkänen. p-Adic Physics as Physics of Cognition and Intention. In *TGD Inspired Theory of Consciousness*. Onlinebook. [http://tgdtheory.com/public\\_html/tgdconsc/tgdconsc.html#cognic](http://tgdtheory.com/public_html/tgdconsc/tgdconsc.html#cognic), 2006.
- [K48] M. Pitkänen. *Physics in Many-Sheeted Space-Time*. Onlinebook. [http://tgdtheory.com/public\\_html/tgdclass/tgdclass.html](http://tgdtheory.com/public_html/tgdclass/tgdclass.html), 2006.
- [K49] M. Pitkänen. Quantum Antenna Hypothesis. In *Quantum Hardware of Living Matter*. Onlinebook. [http://tgdtheory.com/public\\_html/bioware/bioware.html#tubuc](http://tgdtheory.com/public_html/bioware/bioware.html#tubuc), 2006.
- [K50] M. Pitkänen. Quantum Astrophysics. In *Physics in Many-Sheeted Space-Time*. Onlinebook. [http://tgdtheory.com/public\\_html/tgdclass/tgdclass.html#qastro](http://tgdtheory.com/public_html/tgdclass/tgdclass.html#qastro), 2006.
- [K51] M. Pitkänen. Quantum Control and Coordination in Bio-systems: Part I. In *Bio-Systems as Self-Organizing Quantum Systems*. Onlinebook. [http://tgdtheory.com/public\\_html/bioselforg/bioselforg.html#qcococI](http://tgdtheory.com/public_html/bioselforg/bioselforg.html#qcococI), 2006.
- [K52] M. Pitkänen. Quantum Control and Coordination in Bio-Systems: Part II. In *Bio-Systems as Self-Organizing Quantum Systems*. Onlinebook. [http://tgdtheory.com/public\\_html/bioselforg/bioselforg.html#qcococII](http://tgdtheory.com/public_html/bioselforg/bioselforg.html#qcococII), 2006.

- [K53] M. Pitkänen. *Quantum Hardware of Living Matter*. Onlinebook. [http://tgdtheory.com/public\\_html/bioware/bioware.html](http://tgdtheory.com/public_html/bioware/bioware.html), 2006.
- [K54] M. Pitkänen. Quantum Model for Hearing. In *TGD and EEG*. Onlinebook. [http://tgdtheory.com/public\\_html//tgdeeg/tgdeeg/tgdeeg.html#hearing](http://tgdtheory.com/public_html//tgdeeg/tgdeeg/tgdeeg.html#hearing), 2006.
- [K55] M. Pitkänen. Quantum Model for Nerve Pulse. In *TGD and EEG*. Onlinebook. [http://tgdtheory.com/public\\_html//tgdeeg/tgdeeg/tgdeeg.html#pulse](http://tgdtheory.com/public_html//tgdeeg/tgdeeg/tgdeeg.html#pulse), 2006.
- [K56] M. Pitkänen. Quantum Model for Paranormal Phenomena. In *TGD Inspired Theory of Consciousness*. Onlinebook. [http://tgdtheory.com/public\\_html/tgdconsc/tgdconsc.html#parac](http://tgdtheory.com/public_html/tgdconsc/tgdconsc.html#parac), 2006.
- [K57] M. Pitkänen. Quantum Model for Sensory Representations. In *TGD Inspired Theory of Consciousness*. Onlinebook. [http://tgdtheory.com/public\\_html/tgdconsc/tgdconsc.html#expc](http://tgdtheory.com/public_html/tgdconsc/tgdconsc.html#expc), 2006.
- [K58] M. Pitkänen. Quantum Model of EEG. In *TGD and EEG*. Onlinebook. [http://tgdtheory.com/public\\_html/tgdeeg/tgdeeg.html#eegII](http://tgdtheory.com/public_html/tgdeeg/tgdeeg.html#eegII), 2006.
- [K59] M. Pitkänen. Quantum Model of Memory. In *TGD Inspired Theory of Consciousness*. Onlinebook. [http://tgdtheory.com/public\\_html/tgdconsc/tgdconsc.html#memoryc](http://tgdtheory.com/public_html/tgdconsc/tgdconsc.html#memoryc), 2006.
- [K60] M. Pitkänen. *Quantum Physics as Infinite-Dimensional Geometry*. Onlinebook. [http://tgdtheory.com/public\\_html/tgdgeom/tgdgeom.html](http://tgdtheory.com/public_html/tgdgeom/tgdgeom.html), 2006.
- [K61] M. Pitkänen. *Quantum TGD*. Onlinebook. [http://tgdtheory.com/public\\_html/tgdquant/tgdquant.html](http://tgdtheory.com/public_html/tgdquant/tgdquant.html), 2006.
- [K62] M. Pitkänen. Quantum Theory of Self-Organization. In *Bio-Systems as Self-Organizing Quantum Systems*. Onlinebook. [http://tgdtheory.com/public\\_html/bioselforg/bioselforg.html#selforgac](http://tgdtheory.com/public_html/bioselforg/bioselforg.html#selforgac), 2006.
- [K63] M. Pitkänen. Semi-trance, Mental Illness, and Altered States of Consciousness. In *Magnetospheric Consciousness*. Onlinebook. [http://tgdtheory.com/public\\_html/magnconsc/magnconsc.html#semitrancec](http://tgdtheory.com/public_html/magnconsc/magnconsc.html#semitrancec), 2006.
- [K64] M. Pitkänen. Semitrance, Language, and Development of Civilization. In *Magnetospheric Consciousness*. Onlinebook. [http://tgdtheory.com/public\\_html/magnconsc/magnconsc.html#langsoc](http://tgdtheory.com/public_html/magnconsc/magnconsc.html#langsoc), 2006.
- [K65] M. Pitkänen. TGD and Astrophysics. In *Physics in Many-Sheeted Space-Time*. Onlinebook. [http://tgdtheory.com/public\\_html/tgdclass/tgdclass.html#astro](http://tgdtheory.com/public_html/tgdclass/tgdclass.html#astro), 2006.
- [K66] M. Pitkänen. TGD and Cosmology. In *Physics in Many-Sheeted Space-Time*. Onlinebook. [http://tgdtheory.com/public\\_html/tgdclass/tgdclass.html#cosmo](http://tgdtheory.com/public_html/tgdclass/tgdclass.html#cosmo), 2006.
- [K67] M. Pitkänen. *TGD and EEG*. Onlinebook. [http://tgdtheory.com/public\\_html/tgdeeg/tgdeeg.html](http://tgdtheory.com/public_html/tgdeeg/tgdeeg.html), 2006.
- [K68] M. Pitkänen. *TGD and Fringe Physics*. Onlinebook. [http://tgdtheory.com/public\\_html/freenergy/freenergy.html](http://tgdtheory.com/public_html/freenergy/freenergy.html), 2006.
- [K69] M. Pitkänen. TGD and Nuclear Physics. In *p-Adic Length Scale Hypothesis and Dark Matter Hierarchy*. Onlinebook. [http://tgdtheory.com/public\\_html/paddark/paddark.html#padnucl](http://tgdtheory.com/public_html/paddark/paddark.html#padnucl), 2006.
- [K70] M. Pitkänen. *TGD as a Generalized Number Theory*. Onlinebook. [http://tgdtheory.com/public\\_html/tgdnumber/tgdnumber.html](http://tgdtheory.com/public_html/tgdnumber/tgdnumber.html), 2006.
- [K71] M. Pitkänen. TGD as a Generalized Number Theory: p-Adicization Program. In *TGD as a Generalized Number Theory*. Onlinebook. [http://tgdtheory.com/public\\_html/tgdnumber/tgdnumber.html#visiona](http://tgdtheory.com/public_html/tgdnumber/tgdnumber.html#visiona), 2006.

- [K72] M. Pitkänen. TGD as a Generalized Number Theory: Quaternions, Octonions, and their Hyper Counterparts. In *TGD as a Generalized Number Theory*. Onlinebook. [http://tgdtheory.com/public\\_html/tgdnumber/tgdnumber.html#visionb](http://tgdtheory.com/public_html/tgdnumber/tgdnumber.html#visionb), 2006.
- [K73] M. Pitkänen. TGD Based Model for OBEs. In *TGD Inspired Theory of Consciousness*. Onlinebook. [http://tgdtheory.com/public\\_html/tgdconsc/tgdconsc.html#OBE](http://tgdtheory.com/public_html/tgdconsc/tgdconsc.html#OBE), 2006.
- [K74] M. Pitkänen. *TGD Inspired Theory of Consciousness*. Onlinebook. [http://tgdtheory.com/public\\_html/tgdconsc/tgdconsc.html](http://tgdtheory.com/public_html/tgdconsc/tgdconsc.html), 2006.
- [K75] M. Pitkänen. TGD Inspired Theory of Consciousness. In *Topological Geometrodynamics: Overview*. Onlinebook. [http://tgdtheory.com/public\\_html/tgdview/tgdview.html#tgdconsc2010](http://tgdtheory.com/public_html/tgdview/tgdview.html#tgdconsc2010), 2006.
- [K76] M. Pitkänen. The Notion of Free Energy and Many-Sheeted Space-Time Concept. In *TGD and Fringe Physics*. Onlinebook. [http://tgdtheory.com/public\\_html/freenergy/freenergy.html#freenergy](http://tgdtheory.com/public_html/freenergy/freenergy.html#freenergy), 2006.
- [K77] M. Pitkänen. The Relationship Between TGD and GRT. In *Physics in Many-Sheeted Space-Time*. Onlinebook. [http://tgdtheory.com/public\\_html/tgdclass/tgdclass.html#tgdgrt](http://tgdtheory.com/public_html/tgdclass/tgdclass.html#tgdgrt), 2006.
- [K78] M. Pitkänen. Three new physics realizations of the genetic code and the role of dark matter in bio-systems. In *Genes and Memes*. Onlinebook. [http://tgdtheory.com/public\\_html/genememe/genememe.html#dnatqccodes](http://tgdtheory.com/public_html/genememe/genememe.html#dnatqccodes), 2006.
- [K79] M. Pitkänen. Time, Spacetime and Consciousness. In *Bio-Systems as Conscious Holograms*. Onlinebook. [http://tgdtheory.com/public\\_html/hologram/hologram.html#time](http://tgdtheory.com/public_html/hologram/hologram.html#time), 2006.
- [K80] M. Pitkänen. *Topological Geometrodynamics: an Overview*. Onlinebook. [http://tgdtheory.com/public\\_html/tgdview/tgdview.html](http://tgdtheory.com/public_html/tgdview/tgdview.html), 2006.
- [K81] M. Pitkänen. Topological Quantum Computation in TGD Universe. In *Genes and Memes*. Onlinebook. [http://tgdtheory.com/public\\_html/genememe/genememe.html#tqc](http://tgdtheory.com/public_html/genememe/genememe.html#tqc), 2006.
- [K82] M. Pitkänen. Was von Neumann Right After All. In *Towards M-Matrix*. Onlinebook. [http://tgdtheory.com/public\\_html/tgdquant/tgdquant.html#vNeumann](http://tgdtheory.com/public_html/tgdquant/tgdquant.html#vNeumann), 2006.
- [K83] M. Pitkänen. Wormhole Magnetic Fields. In *Quantum Hardware of Living Matter*. Onlinebook. [http://tgdtheory.com/public\\_html/bioware/bioware.html#wormc](http://tgdtheory.com/public_html/bioware/bioware.html#wormc), 2006.





# Articles about TGD

- [L1] M. Pitkänen. Macro-temporal quantum coherence, quantum spin glass degeneracy, and number theoretic information concept. <http://www.emergentmind.org/journal.htm>, 2003.
- [L2] M. Pitkänen. Time, Space-Time, and Consciousness. <http://www.emergentmind.org/journal.htm>, 2003.
- [L3] M. Pitkänen. Further Progress in Nuclear String Hypothesis. <http://tgdtheory.com/articles/nuclstring.pdf>, 2007.
- [L4] M. Pitkänen. TGD based solution of Fermi paradox. <http://www.physics.helsinki.fi/~matpitka/articles/fermieng.pdf>, 2007.



**Part II**

**GENERAL THEORY**



## Chapter 4

# Construction of Quantum Theory: Symmetries

### 4.1 Introduction

This chapter provides a summary about the role of symmetries in the construction of quantum TGD. The discussions are based on the general vision that quantum states of the Universe correspond to the modes of classical spinor fields in the "world of the classical worlds" (WCW) identified as the infinite-dimensional configuration space of light-like 3-surfaces of  $H = M^4 \times CP_2$  (more or less-equivalently, the corresponding 4-surfaces defining generalized Bohr orbits). The following topics are discussed on basis of this vision.

#### 4.1.1 Physics as infinite-dimensional Kähler geometry

1. The basic idea is that it is possible to reduce quantum theory to configuration space geometry and spinor structure. The geometrization of loop spaces inspires the idea that the mere existence of Riemann connection fixes configuration space Kähler geometry uniquely. Accordingly, configuration space can be regarded as a union of infinite-dimensional symmetric spaces labeled by zero modes labeling classical non-quantum fluctuating degrees of freedom.

The huge symmetries of the configuration space geometry deriving from the light-likeness of 3-surfaces and from the special conformal properties of the boundary of 4-D light-cone would guarantee the maximal isometry group necessary for the symmetric space property. Quantum criticality is the fundamental hypothesis allowing to fix the Kähler function and thus dynamics of TGD uniquely. Quantum criticality leads to surprisingly strong predictions about the evolution of coupling constants.

2. Configuration space spinors correspond to Fock states and anti-commutation relations for fermionic oscillator operators correspond to anti-commutation relations for the gamma matrices of the configuration space. Configuration space gamma matrices contracted with Killing vector fields give rise to a super-symplectic algebra which together with Hamiltonians of the configuration space forms what I have used to call super-symplectic algebra.

Super-symplectic degrees of freedom represent completely new degrees of freedom and have no electroweak couplings. In the case of hadrons super-symplectic quanta correspond to what has been identified as non-perturbative sector of QCD: they define TGD correlate for the degrees of freedom assignable to hadronic strings. They are responsible for the most of the mass of hadron and resolve spin puzzle of proton.

3. Besides super-symplectic symmetries there are Super-Kac Moody symmetries assignable to light-like 3-surfaces and together these algebras extend the conformal symmetries of string models to dynamical conformal symmetries instead of mere gauge symmetries. The construction of the representations of these symmetries is one of the main challenges of quantum TGD.

4. Modular invariance is one aspect of conformal symmetries and plays a key role in the understanding of elementary particle vacuum functionals and the description of family replication phenomenon in terms of the topology of partonic 2-surfaces.
5. Modified Dirac equation gives also rise to a hierarchy super-conformal algebras assignable to zero modes. These algebras follow from the existence of conserved fermionic currents. The corresponding deformations of the space-time surface correspond to vanishing second variations of Kähler action and provide a realization of quantum criticality. This led to a breakthrough in the understanding of the modified Dirac action via the addition of a measurement interaction term to the action allowing to obtain among other things stringy propagator and the coding of quantum numbers of super-conformal representations to the geometry of space-time surfaces required by quantum classical correspondence.
6. The effective 2-dimensionality of the space-like 3-surfaces realizing quantum holography can be formulated as a symmetry stating that the replacement of wormhole throat by any light-like 3-surfaces parallel to it in the slicing of the space-time sheet induces only a gauge transformation of WCW Kähler function adding to it a real part of a holomorphic function of complex coordinate of WCW depending also on zero modes. This means that the Kähler metric of WCW remains invariant. It is also postulated that measurement interaction added to the modified Dirac action induces similar gauge symmetry.
7. The study of the modified Dirac equation leads to a detailed identification of super charges of the super-conformal algebras relevant for TGD [?]: these results represent the most recent layer in the development of ideas about supersymmetry in TGD Universe. Whereas many considerations related to supersymmetry represented earlier rely on general arguments, the results deriving from the modified Dirac equation are rather concrete and clarify the crucial role of the right-handed neutrino in TGD based realization of super-conformal symmetries.  $\mathcal{N} = 1$  SUSY- now almost excluded at LHC - is not possible in TGD because it requires Majorana spinors. Also  $\mathcal{N} = 2$  variant of the standard space-time SUSY seems to be excluded in TGD Universe. Fermionic oscillator operators for the induced spinor fields restricted to 2-D surfaces however generate large  $\mathcal{N}$  SUSY and super-conformal algebra and the modes of right-handed neutrino its 4-D version.

### 4.1.2 p-Adic physics as physics of cognition and intentionality

p-Adic mass calculations relying on p-adic length scale hypothesis led to an understanding of elementary particle masses using only super-conformal symmetries and p-adic thermodynamics. The need to fuse real physics and various p-adic physics to single coherent whole led to a generalization of the notion of number obtained by gluing together reals and p-adics together along common rationals and algebraics. The interpretation of p-adic space-time sheets is as correlates for cognition and intentionality. p-Adic and real space-time sheets intersect along common rationals and algebraics and the subset of these points defines what I call number theoretic braid in terms of which both configuration space geometry and S-matrix elements should be expressible. Thus one would obtain number theoretical discretization, which involves no adhoc elements and is inherent to the physics of TGD.

The original idea was that the notion of number theoretic braid could pose strong number theoretic conditions on physics just as p-adic thermodynamics poses on elementary particle mass spectrum. A practically oriented physicist would argue that general braids must be allowed if one wants to calculate something and that number theoretic braids represent only the intersection between the real and various p-adic physics. He could also insist that at the level of WCW various sectors must be realized in a more abstract manner - say as hierarchies of polynomials with coefficients belonging to various extensions or rationals so that one can speak about surfaces common to real and various p-adic sectors. In this view the fusion of various physics would be analogous to the completion of rationals to various number fields.

Perhaps the most dramatic implication relates to the fact that points, which are p-adically infinitesimally close to each other, are infinitely distant in the real sense (recall that real and p-adic imbedding spaces are glued together along rational imbedding space points). This means that any open set of p-adic space-time sheet is discrete and of infinite extension in the real sense. This means that cognition is a cosmic phenomenon and involves always discretization from the point of view of the

real topology. The testable physical implication of effective p-adic topology of real space-time sheets is p-adic fractality meaning characteristic long range correlations combined with short range chaos.

Also a given real space-time sheets should correspond to a well-defined prime or possibly several of them. The classical non-determinism of Kähler action should correspond to p-adic non-determinism for some prime(s)  $p$  in the sense that the effective topology of the real space-time sheet is p-adic in some length scale range. p-Adic space-time sheets with same prime should have many common rational points with the real space-time and be easily transformable to the real space-time sheet in quantum jump representing intention-to-action transformation. The concrete model for the transformation of intention to action leads to a series of highly non-trivial number theoretical conjectures assuming that the extensions of p-adics involved are finite-dimensional and can contain also transcendentals.

An ideal realization of the space-time sheet as a cognitive representation results if the  $CP_2$  coordinates as functions of  $M_+^4$  coordinates have the same functional form for reals and various p-adic number fields and that these surfaces have discrete subset of rational numbers with upper and lower length scale cutoffs as common. The hierarchical structure of cognition inspires the idea that S-matrices form a hierarchy labeled by primes  $p$  and the dimensions of algebraic extensions.

The number-theoretic hierarchy of extensions of rationals appears also at the level of configuration space spinor fields and allows to replace the notion of entanglement entropy based on Shannon entropy with its number theoretic counterpart having also negative values in which case one can speak about genuine information. In this case case entanglement is stable against Negentropy Maximization Principle stating that entanglement entropy is minimized in the self measurement and can be regarded as bound state entanglement. Bound state entanglement makes possible macro-temporal quantum coherence. One can say that rationals and their finite-dimensional extensions define islands of order in the chaos of continua and that life and intelligence correspond to these islands.

TGD inspired theory of consciousness and number theoretic considerations inspired for years ago the notion of infinite primes [?] . It came as a surprise, that this notion might have direct relevance for the understanding of mathematical cognition. The idea is very simple. There is infinite hierarchy of infinite rationals having real norm one but different but finite p-adic norms. Thus single real number (complex number, (hyper-)quaternion, (hyper-)octonion) corresponds to an algebraically infinite-dimensional space of numbers equivalent in the sense of real topology. Space-time and imbedding space points become infinitely structured and single space-time point would represent the Platonia of mathematical ideas. This structure would be completely invisible at the level of real physics but would be crucial for mathematical cognition and explain why we are able to imagine also those mathematical structures which do not exist physically. Space-time could be also regarded as an algebraic hologram. The connection with Brahman=Atman idea is also obvious.

### 4.1.3 Hierarchy of Planck constants and dark matter hierarchy

The work with HFFs combined with experiment The realization for the hierarchy of Planck constants proposed as a solution to the dark matter puzzles leads to a profound generalization of quantum TGD through a generalization of the notion of imbedding space to characterize quantum criticality. The resulting space has a book like structure with various almost-copies of the imbedding space representing the pages of the book meeting at quantum critical sub-manifolds. A particular page of the book can be seen as an n-fold singular covering or factor space of  $CP_2$  or of a causal diamond ( $CD$ ) of  $M^4$  defined as an intersection of the future and past directed light-cones. Therefore the cyclic groups  $Z_n$  appear as discrete symmetry groups.

### 4.1.4 Number theoretical symmetries

TGD as a generalized number theory vision leads to the idea that also number theoretical symmetries are important for physics.

1. There are good reasons to believe that the strands of number theoretical braids can be assigned with the roots of a polynomial with suggests the interpretation corresponding Galois groups as purely number theoretical symmetries of quantum TGD. Galois groups are subgroups of the permutation group  $S_\infty$  of infinitely manner objects acting as the Galois group of algebraic numbers. The group algebra of  $S_\infty$  is HFF which can be mapped to the HFF defined by configuration space spinors. This picture suggest a number theoretical gauge invariance stating

that  $S_\infty$  acts as a gauge group of the theory and that global gauge transformations in its completion correspond to the elements of finite Galois groups represented as diagonal groups of  $G \times G \times \dots$  of the completion of  $S_\infty$ .

2. HFFs inspire also an idea about how entire TGD emerges from classical number fields, actually their complexifications. In particular,  $SU(3)$  acts as subgroup of octonion automorphisms leaving invariant preferred imaginary unit. If space-time surfaces are hyper-quaternionic (meaning that the octonionic counterparts of the modified gamma matrices span complex quaternionic sub-algebra of octonions) and contain at each point a preferred plane  $M^2$  of  $M^4$ , one ends up with  $M^8 - H$  duality stating that space-time surfaces can be equivalently regarded as surfaces in  $M^8$  or  $M^4 \times CP_2$ . One can actually generalize  $M^2$  to a two-dimensional Minkowskian sub-manifold of  $M^4$ . One ends up with quantum TGD by considering associative sub-algebras of the local octonionic Clifford algebra of  $M^8$  or  $H$ . so that TGD could be seen as a generalized number theory.

## 4.2 Symmetries

The most general expectation is that configuration space can be regarded as a union of coset spaces which are infinite-dimensional symmetric spaces with Kähler structure:  $C(H) = \cup_i G/H(i)$ . Index  $i$  labels 3-topology and zero modes. The group  $G$ , which can depend on 3-surface, can be identified as a subgroup of diffeomorphisms of  $\delta M_+^4 \times CP_2$  and  $H$  must contain as its subgroup a group, whose action reduces to  $Diff(X^3)$  so that these transformations leave 3-surface invariant.

The task is to identify plausible candidate for  $G$  and  $H$  and to show that the tangent space of the configuration space allows Kähler structure, in other words that the Lie-algebras of  $G$  and  $H(i)$  allow complexification. One must also identify the zero modes and construct integration measure for the functional integral in these degrees of freedom. Besides this one must deduce information about the explicit form of configuration space metric from symmetry considerations combined with the hypothesis that Kähler function is Kähler action for a preferred extremal of Kähler action. One must of course understand what "preferred" means.

### 4.2.1 General Coordinate Invariance and generalized quantum gravitational holography

The basic motivation for the construction of configuration space geometry is the vision that physics reduces to the geometry of classical spinor fields in the infinite-dimensional configuration space of 3-surfaces of  $M_+^4 \times CP_2$  or of  $M^4 \times CP_2$ . Hermitian conjugation is the basic operation in quantum theory and its geometrization requires that configuration space possesses Kähler geometry. Kähler geometry is coded into Kähler function.

The original belief was that the four-dimensional general coordinate invariance of Kähler function reduces the construction of the geometry to that for the boundary of configuration space consisting of 3-surfaces on  $\delta M_+^4 \times CP_2$ , the moment of big bang. The proposal was that Kähler function  $K(Y^3)$  could be defined as a preferred extremal of so called Kähler action for the unique space-time surface  $X^4(Y^3)$  going through given 3-surface  $Y^3$  at  $\delta M_+^4 \times CP_2$ . For  $Diff^4$  transforms of  $Y^3$  at  $X^4(Y^3)$  Kähler function would have the same value so that  $Diff^4$  invariance and degeneracy would be the outcome. The proposal was that the preferred extremals are absolute minima of Kähler action.

This picture turned out to be too simple.

1. I have already described the recent view about light-like 3-surfaces as generalized Feynman diagrams and space-time surfaces as preferred extremals of Kähler action and will not repeat what has been said.
2. It has also become obvious that the gigantic symmetries associated with  $\delta M_\pm^4 \times CP_2 \subset CD \times CP_2$  manifest themselves as the properties of propagators and vertices. Cosmological considerations, Poincare invariance, and the new view about energy favor the decomposition of the configuration space to a union of configuration spaces assignable to causal diamonds  $CD$ s defined as intersections of future and past directed light-cones. The minimum assumption is that  $CD$ s label the sectors of  $CH$ : the nice feature of this option is that the considerations of this chapter



restricted to  $\delta M_{\pm}^4 \times CP_2$  generalize almost trivially. This option is beautiful because the center of mass degrees of freedom associated with the different sectors of  $CH$  would correspond to  $M^4$  itself and its Cartesian powers.

The definition of the Kähler function requires that the many-to-one correspondence  $X^3 \rightarrow X^4(X^3)$  must be replaced by a bijective correspondence in the sense that  $X_l^3$  as light-like 3-surface is unique among all its  $\text{Diff}^4$  translates. This also allows physically preferred "gauge fixing" allowing to get rid of the mathematical complications due to  $\text{Diff}^4$  degeneracy. The internal geometry of the space-time sheet must define the preferred 3-surface  $X_l^3$ .

The realization of this vision means a considerable mathematical challenge. The effective metric 2-dimensionality of 3-dimensional light-like surfaces  $X_l^3$  of  $M^4$  implies generalized conformal and symplectic symmetries allowing to generalize quantum gravitational holography from light like boundary so that the complexities due to the non-determinism can be taken into account properly.

### 4.2.2 Light like 3-D causal determinants and effective 2-dimensionality

The light like 3-surfaces  $X_l^3$  of space-time surface appear as 3-D causal determinants. Basic examples are boundaries and elementary particle horizons at which Minkowskian signature of the induced metric transforms to Euclidian one. This brings in a second conformal symmetry related to the metric 2-dimensionality of the 3-D light-like 3-surface. This symmetry is identifiable as TGD counterpart of the Kac Moody symmetry of string models. The challenge is to understand the relationship of this symmetry to configuration space geometry and the interaction between the two conformal symmetries.

1. Field-particle duality is realized. Light-like 3-surfaces  $X_l^3$  -generalized Feynman diagrams - correspond to the particle aspect of field-particle duality whereas the physics in the interior of space-time surface  $X^4(X_l^3)$  would correspond to the field aspect. Generalized Feynman diagrams in 4-D sense could be identified as regions of space-time surface having Euclidian signature.
2. One could also say that light-like 3-surfaces  $X_l^3$  and the space-like 3-surfaces  $X^3$  in the intersections of  $X^4(X_l^3) \cap CD \times CP_2$  where the causal diamond  $CD$  is defined as the intersections of future and past directed light-cones provide dual descriptions.
3. Generalized coset construction implies that the differences of super-symplectic and Super Kac-Moody type Super Virasoro generators annihilated physical states. This implies Equivalence Principle. This construction in turn led to the realization that configuration space for fixed values of zero modes - in particular the values of the induced Kähler form of  $\delta M_{\pm}^4 \times CP_2$  - allows identification as a coset space obtained by dividing the symplectic group of  $\delta M_{\pm}^4 \times CP_2$  with Kac-Moody group, whose generators vanish at  $X^2 = X_l^3 \times \delta M_{\pm}^4 \times CP_2$ . One can say that quantum fluctuating degrees of freedom in a very concrete sense correspond to the local variant of  $S^2 \times CP_2$ .

The analog of conformal invariance in the light-like direction of  $X_l^3$  and in the light-like radial direction of  $\delta M_{\pm}^4$  implies that the data at either  $X^3$  or  $X_l^3$  should be enough to determine configuration space geometry. This implies that the relevant data is contained to their intersection  $X^2$  at least for finite regions of  $X^3$ . This is the case if the deformations of  $X_l^3$  not affecting  $X^2$  and preserving light-likeness corresponding to zero modes or gauge degrees of freedom and induce deformations of  $X^3$  also acting as zero modes. The outcome is effective 2-dimensionality. One must be however cautious in order to not make over-statements. The reduction to 2-D theory in global sense would trivialize the theory and the reduction to 2-D theory must takes places for finite region of  $X^3$  only so one has in well defined sense three-dimensionality in discrete sense. A more precise formulation of this vision is in terms of hierarchy of  $CD$ s containing  $CD$ s containing.... The introduction of sub- $CD$ :s brings in improved measurement resolution and means also that effective 2-dimensionality is realized in the scale of sub- $CD$  only.

One cannot over-emphasize the importance of the effective 2-dimensionality. It indeed simplifies dramatically the earlier formulas for configuration space metric involving 3-dimensional integrals over  $X^3 \subset M_{\pm}^4 \times CP_2$  reducing now to 2-dimensional integrals. Note that  $X^3$  is determined by preferred extremal property of  $X^4(X_l^3)$  once  $X_l^3$  is fixed and one can hope that this mapping is one-to-one.

### 4.2.3 Magic properties of light cone boundary and isometries of configuration space

The special conformal, metric and symplectic properties of the light cone of four-dimensional Minkowski space:  $\delta M_+^4$ , the boundary of four-dimensional light cone is metrically 2-dimensional(!) sphere allowing infinite-dimensional group of conformal transformations and isometries(!) as well as Kähler structure. Kähler structure is not unique: possible Kähler structures of light cone boundary are parametrized by Lobatchevski space  $SO(3,1)/SO(3)$ . The requirement that the isotropy group  $SO(3)$  of  $S^2$  corresponds to the isotropy group of the unique classical 3-momentum assigned to  $X^4(Y^3)$  defined as a preferred extremum of Kähler action, fixes the choice of the complex structure uniquely. Therefore group theoretical approach and the approach based on Kähler action complement each other.

1. The allowance of an infinite-dimensional group of isometries isomorphic to the group of conformal transformations of 2-sphere is completely unique feature of the 4-dimensional light cone boundary. Even more, in case of  $\delta M_+^4 \times CP_2$  the isometry group of  $\delta M_+^4$  becomes localized with respect to  $CP_2$ ! Furthermore, the Kähler structure of  $\delta M_+^4$  defines also symplectic structure.

Hence any function of  $\delta M_+^4 \times CP_2$  would serve as a Hamiltonian transformation acting in both  $CP_2$  and  $\delta M_+^4$  degrees of freedom. These transformations obviously differ from ordinary local gauge transformations. This group leaves the symplectic form of  $\delta M_+^4 \times CP_2$ , defined as the sum of light cone and  $CP_2$  symplectic forms, invariant. The group of symplectic transformations of  $\delta M_+^4 \times CP_2$  is a good candidate for the isometry group of the configuration space.

2. The approximate symplectic invariance of Kähler action is broken only by gravitational effects and is exact for vacuum extremals. If Kähler function were exactly invariant under the symplectic transformations of  $CP_2$ ,  $CP_2$  symplectic transformations would correspond to zero modes having zero norm in the Kähler metric of configuration space. This does not make sense since symplectic transformations of  $\delta M_+^4 \times CP_2$  actually parameterize the quantum fluctuation degrees of freedom.
3. The groups  $G$  and  $H$ , and thus configuration space itself, should inherit the complex structure of the light cone boundary. The diffeomorphisms of  $M^4$  act as dynamical symmetries of vacuum extremals. The radial Virasoro localized with respect to  $S^2 \times CP_2$  could in turn act in zero modes perhaps inducing conformal transformations: note that these transformations lead out from the symmetric space associated with given values of zero modes.

### 4.2.4 Symplectic transformations of $\delta M_+^4 \times CP_2$ as isometries of configuration space

The symplectic transformations of  $\delta M_+^4 \times CP_2$  are excellent candidates for inducing symplectic transformations of the configuration space acting as isometries. There are however deep differences with respect to the Kac Moody algebras.

1. The conformal algebra of the configuration space is gigantic when compared with the Virasoro + Kac Moody algebras of string models as is clear from the fact that the Lie-algebra generator of a symplectic transformation of  $\delta M_+^4 \times CP_2$  corresponding to a Hamiltonian which is product of functions defined in  $\delta M_+^4$  and  $CP_2$  is sum of generator of  $\delta M_+^4$ -local symplectic transformation of  $CP_2$  and  $CP_2$ -local symplectic transformations of  $\delta M_+^4$ . This means also that the notion of local gauge transformation generalizes.
2. The physical interpretation is also quite different: the relevant quantum numbers label the unitary representations of Lorentz group and color group, and the four-momentum labeling the states of Kac Moody representations is not present. Physical states carrying no energy and momentum at quantum level are predicted. The appearance of a new kind of angular momentum not assignable to elementary particles might shed some light to the longstanding problem of baryonic spin (quarks are not responsible for the entire spin of proton). The possibility of a new kind of color might have implications even in macroscopic length scales.
3. The central extension induced from the natural central extension associated with  $\delta M_+^4 \times CP_2$  Poisson brackets is anti-symmetric with respect to the generators of the symplectic algebra rather than symmetric as in the case of Kac Moody algebras associated with loop spaces. At

first this seems to mean a dramatic difference. For instance, in the case of  $CP_2$  symplectic transformations localized with respect to  $\delta M_+^4$  the central extension would vanish for Cartan algebra, which means a profound physical difference. For  $\delta M_+^4 \times CP_2$  symplectic algebra a generalization of the Kac Moody type structure however emerges naturally.

The point is that  $\delta M_+^4$ -local  $CP_2$  symplectic transformations are accompanied by  $CP_2$  local  $\delta M_+^4$  symplectic transformations. Therefore the Poisson bracket of two  $\delta M_+^4$  local  $CP_2$  Hamiltonians involves a term analogous to a central extension term symmetric with respect to  $CP_2$  Hamiltonians, and resulting from the  $\delta M_+^4$  bracket of functions multiplying the Hamiltonians. This additional term could give the entire bracket of the configuration space Hamiltonians at the maximum of the Kähler function where one expects that  $CP_2$  Hamiltonians vanish and have a form essentially identical with Kac Moody central extension because it is indeed symmetric with respect to indices of the symplectic group.

#### 4.2.5 Does the symmetric space property reduce to coset construction for Super Virasoro algebras?

The idea about symmetric space is extremely beautiful but it took a long time and several false alarms before the time was ripe for identifying the precise form of the Cartan decomposition  $g = t + h$  satisfying the defining conditions

$$g = t + h \quad , \quad [t, t] \subset h \quad , \quad [h, t] \subset t \quad . \quad (4.2.1)$$

The ultimate solution of the puzzle turned out to be amazingly simple and came only after quantum TGD was understood well enough.

Configuration space geometry allows two super-conformal symmetries. The first one corresponds to super-symplectic transformations acting at the level of imbedding space. The second one corresponds to super Kac-Moody symmetry acting as deformations of light-like 3-surfaces respecting their light-likeness. Super Kac-Moody algebra can be regarded as sub-algebra of super-symplectic algebra, and quantum states correspond to the coset representations for these two algebras so that the differences of the corresponding super-Virasoro generators annihilate physical states. This obviously generalizes Goddard-Olive-Kent construction [?]. The physical interpretation is in terms of Equivalence Principle. After having realized this it took still some time to realize that this coset representation and therefore also Equivalence Principle also corresponds to the coset structure of the configuration space!

The first guess would be that  $t$  corresponds to super-symplectic algebra made also local with respect to  $X^3$  and  $h$  corresponds to super Kac-Moody algebra. The experience with finite-dimensional coset spaces would suggest that super Kac-Moody generators interpreted in terms of  $h$  leave the points of configuration space analogous to the origin of say  $CP_2$  invariant and in fact vanish at this point. Therefore super Kac-Moody generators should vanish for those 3-surfaces  $X_l^3$  which correspond to the origin of coset space. The maxima of Kähler function could correspond to this kind of points and could play also an essential role in the integration over configuration space by generalizing the Gaussian integration of free quantum field theories. The dynamical Kac-Moody algebra appearing in p-adic mass calculations and in coset construction would be a larger algebra affecting also  $X^2$ . Thus one must distinguish between the Kac-Moody algebras associated with the coset construction and coset space.

The first guess is not quite correct. The generators of super-symplectic and super Kac-Moody algebra are not completely free functions of  $X^3$  coordinates. The condition that they leave induced  $CP_2$  Kähler form  $J_{\mu\nu}(x)$  of the partonic 2-surfaces  $X^2(v) \subset X_l^3$  ( $v$  is light-like coordinate of  $X_l^3$ ) invariant implies that they depend on the symplectic invariant  $J = \epsilon^{\mu\nu} J_{\mu\nu}(x)$  only.  $J$  obviously takes the role of complex coordinate [?].

#### 4.2.6 What effective 2-dimensionality and holography really mean?

Concerning the interpretation of Kac-Moody algebra there are some poorly understood points, which directly relate to what one means with holography.

1. The strongest view about effective 2-dimensionality (holography) is that for preferred extremals the partonic 2-surfaces  $X^2$  at the ends of  $CD$  act as causal determinants fixing  $X_l^3$  in the

resolution defined by  $CD$ . A weaker view about holography is that light-like 3-surfaces with fixed ends give rise to same configuration space metric and the deformations of these surfaces by Kac-Moody algebra correspond to zero modes just like the interior degrees of freedom for space-like 3-surface do. Which of these options is the correct one? The same question can be posed in the case of space-like 3-surfaces.

2. The non-trivial action of Kac-Moody algebra in the interior of  $X_l^3$  together with effective 2-dimensionality and holography would encourage the interpretation of Kac-Moody symmetries acting trivially at  $X^2$  as gauge symmetries. Light-like 3-surfaces having fixed partonic 2-surfaces at their ends would be equivalent physically and effective 2-dimensionality and holography would be realized modulo gauge transformations.
3. There are also Kac-Moody generators which do not vanish at the ends of the  $X_l^3$ , and these would act as physical symmetries and their action would reduce at  $X^2$  to symplectic action. This Kac-Moody algebra should appear in p-adic mass calculations. This seems to be in conflict with the idea that coset construction corresponds to coset space construction. Perhaps strict correspondence is too naive an assumption. Why couldn't one use the larger Kac-Moody algebra in coset construction and smaller Kac-Moody algebra in coset space construction?
4. Gauge symmetry property means that the Kähler metric of the configuration space is same for all gauge equivalent choices of  $X_l^3$  and Kac-Moody deformations correspond to zero modes. Kähler function could differ by a real part of a holomorphic function of configuration space coordinates representing now Kac-Moody transforms of  $X_l^3$ . If Dirac determinant gives the exponent of Kähler function, the eigenvalues of the modified Dirac action can differ only by scalings with are products of holomorphic function of configuration space coordinates and its conjugates labeling different Kac-Moody transforms of  $X_l^3$ . This condition makes sense if one restricts the consideration to the finite number of eigenvalues  $\lambda_k$  assigned to  $D_K$ . The introduction of instanton term transforming the eigenvalues to  $\lambda_k + \sqrt{n}$  would not allow his scaling.

Either one must assume more general spectrum of form  $\lambda_k + \sqrt{n}x_k$  with  $\lambda_k$  and  $x_k$  scaling in identical manner or that  $n = 0$  modes are enough to define Kähler function. The latter option might be correct since the preferred extremal realizes effective 2-dimensionality at space-time level and conformal excitations break it so that they should not contribute to Kähler function. Also number theoretic universality favors this option. One cannot however exclude the first option. It must be admitted that the situation is not completely understood.

#### 4.2.7 About the relationship between super-symplectic and super Kac-Moody algebras

The relationship between Kac-Moody and symplectic algebras is now relatively well understood but the physical interpretation of Kac-Moody algebra deserves attention. There are two Kac-Moody algebras: the smaller one leaves partonic 2-surfaces invariant and second one affects also them. Both of them are in dual relation to the symplectic algebra and these relations correspond to coset space construction and coset construction.

TGD inspired quantum measurement theory suggests that the super-symplectic algebra and smaller Kac-Moody algebra correspond to each other like classical and quantal degrees of freedom. Hence smaller Kac-Moody algebra would act in the zero modes of the configuration space metric. In the proposed construction this indeed is the case for Kac-Moody algebra elements leaving partonic 2-surface invariant and appearing in the *coset space construction* but not for those Kac-Moody algebra elements affecting partonic 2-surface and allowing interpretation as sub-algebra of symplectic algebra and appearing in *coset construction*. This interpretation conforms also with the fact that Kac-Moody algebra generates massive excitations in p-adic thermodynamics.

In TGD inspired quantum measurement zero modes correspond to classical non-quantum fluctuating dynamical variables in 1-1 correspondence with quantum fluctuating degrees of freedom like the positions of the pointer of the measurement apparatus with the directions of spin of electron. Hence Kac-Moody algebra would define configuration space coordinates in terms of the map induced by correlation between classical and quantal degrees of freedom induced by entanglement. The choice of gauge selecting one particular light-like 3-surface  $X_l^3$  could have thus interpretation as a map mapping

quantum degrees of freedom to classical ones. This choice of gauge could be achieved by the addition of phase factor depending on quantum numbers assigned with the braid strands so that stationary phase approximation would select the preferred 3-surface with fluctuations around them allowed.

The dual relation between super symplectic algebra and bigger Kac-Moody algebra is realized in terms of coset construction. The idea inspired by Olive-Goddard-Kent coset construction is that the generators of Super Virasoro algebra corresponds to the differences of those associated with Super Kac-Moody and super-symplectic algebras. The justification comes from the miraculous geometry of the light cone boundary implying that Super Kac-Moody conformal symmetries of  $X^2$  can be compensated by super-symplectic local radial scalings so that the differences of corresponding Super Virasoro generators annihilate physical states. If the central extension parameters are same, the resulting central extension is trivial. What is done is to construct first a state with a non-positive conformal weight using super-symplectic generators, and then to apply Super-Kac Moody generators to compensate this conformal weight to get a state with vanishing conformal weight. Mass squared would however correspond to either Super-Kac Moody or super-symplectic mass. The identity of these masses gives rise to Equivalence Principle as a one manifestation of the coset representation.

### Basic super-conformal symmetries

The identification of explicit representations of super conformal algebras was for a long time plagued by the lack of appropriate formalism. The modified Dirac operator  $D_K$  associated with Kähler action resolves this problem if one accepts the implications of number theoretic compactification supported by what is known about preferred extremals of Kähler action and one can identify the charges associated with symplectic and Kac-Moody algebra as Noether charges. Fermionic generators can in turn be identified from the condition that they anticommute to  $X^2$  local Hamiltonians of corresponding bosonic transformations. In case of Super Virasoro algebra Sugawara construction allows to construct super generators  $G$ .

1. Covariantly constant right handed neutrino is the fundamental generator of dynamical super conformal symmetries and appears in both leptonic and quark-like realizations of gamma matrices.  $\Gamma$  matrices have also Super Kac-Moody counterparts and reduce in special case to symplectic ones. Also super currents whose anti-commutators give products of corresponding Hamiltonians can be defined so that both ordinary product and Poisson bracket give rise to quark and lepton like realizations of super-symmetries. Besides this there are also electric and magnetic representations of the gamma matrices.
2. The zero modes of  $D_K(X^2)$  which do not depend on the light-like radial coordinate of  $X_l^3$  define super conformal symmetries for which any c-number spinor field generates super conformal symmetry. These symmetries are pure gauge symmetries but also them can be parameterized by Hamiltonians and by functions depending only on the coordinates of the transverse section  $X^2$  so that one obtains also now both function algebra and symplectic algebra localized with respect to  $X^2$ . Similar picture applies in both super-symplectic and super Kac-Moody sector. In particular, one can deduce canonical expressions for the super currents associated with these super symmetries. Since all charge states are possible for the generators of these super symmetries, these super symmetries naturally correspond to those assignable to electro-weak degrees of freedom.
3. The notion of  $X^2$  local super-symmetry makes sense if the choice of coordinates  $x$  for  $X^2$  is specified by the inherent properties of  $X^2$  so that same coordinates  $x$  apply for all surfaces obtained as deformations of  $X^2$ . The regions, where induced Kähler form is non-vanishing define good candidates for coordinate patches. The Hamilton-Jacobi coordinates associated with the decomposition of  $M^4$  are a natural choice. Also geodesic coordinates can be considered. The redundancy related to rotations of coordinate axis around origin can be reduced by choosing second axis so that it connects the origin to nearest point of the number theoretic braid.
4. The diffeomorphisms of light-like coordinate of  $\delta M_{\pm}^4$  and  $X_l^3$  playing the role of conformal transformations. One can construct fermionic representations of as Noether charges associated with modified Dirac action. The problem is however that that super-generators cannot be derived in this manner so that these transformations cannot be regarded as symplectic transformations.

The manner to circumvent the difficulty is to construct fermionic super charges  $\Gamma_A$  as gamma matrices for both super symplectic and super Kac-Moody algebras in terms of generators  $j^{Ak}\Gamma_k$  and corresponding Kac-Moody algebra elements  $T^A$  as fermionic super charges. From these operators super generators  $G$  can be constructed by the standard Sugawara construction allowing to interpret operators  $G = T^A\Gamma_A$  as Dirac operators at the level of configuration space. By coset construction the actions of super-symplectic and super Kac-Moody Dirac operators are identical. Internal consistency requires that the Virasoro generators obtained as anticommutator  $L = \{G, G^\dagger\}$  are equal to the Virasoro generators derived as fermionic Noether charges.

### Finite measurement resolution and cutoff in the spectrum of conformal weights

The basic properties of Kähler action imply that the number generalized eigenvalues  $\lambda_i$  of  $D_K(X^2)$  is finite. The interpretation is that the notion of finite measurement resolution is coded by Kähler action to space-time dynamics. This has also implications for the representations of super-conformal algebras.

1. The fermionic representations of various super-algebras involve only finite number of oscillator operators. Hence some kind of cutoff in the number of states reflecting the finiteness of the measurement resolution is unavoidable. A cutoff reduce integers as labels of the generators of super-conformal algebras to a finite number of integers. Finite field  $G(p, 1)$  for some prime  $p$  would be a natural candidate. Since p-adic integers modulo  $p$  are in question the cutoff could relate closely to effective p-adicity and p-adic length scale-hypothesis.
2. The interpretation of the eigenvalues of the modified Dirac operator as ground state conformal weights raises the question how to represent states with conformal weights  $n + \lambda_i^2$ ,  $n > 0$ . The notion of number theoretic braid allows to circumvent the difficulty. Since canonical anti-commutation relations fail, one must replace the integral representations of super-conformal generators with discrete sums over the points of number theoretic braid, the resulting representations of super-conformal algebras must reduce to representation of finite-dimensional algebras. The cutoff on conformal weight must result from the fact that the higher Virasoro generators are expressible in terms of lower ones. The cutoff is not a problem since  $n < 3$  cutoff for conformal weights gives an excellent accuracy in p-adic mass calculations. A not-very-educated guess but the only one that one can imagine is that for  $p \simeq 2^k$ ,  $n_{max} = k$  defines the cutoff on allowed conformal weights.

### Generalized coset representation

$X^2$  local super-symplectic algebra as super Kac-Moody algebra as sub-algebra. Since  $X^2$  locality corresponds to a full 2-D gauge invariance, one can conclude that SKM is in well defined sense sub-algebra of super-symplectic algebra so that generalized coset construction makes sense and generalizes Equivalence Principle in the sense that not only four-momenta but all analogous quantum numbers associated with SKM and SS algebras are identical.

1. In this framework the ground state conformal weights associated with both super-symplectic and super Kac-Moody algebras can be identified as squares of the eigenvalues  $\lambda_i$  of  $D_K(X^2)$ . This identification together with p-adic mass thermodynamics predicts that  $\lambda_i^2$  gives to mass squared a contribution analogous to the square of Higgs vacuum expectation. This identification would resolve the long-standing problem of identifying the values of these ground state conformal weights for super-conformal algebras and give a direct connection with Higgs mechanism.
2. The identification of SKM as a sub-algebra of super-symplectic algebra becomes more convincing if the light-like coordinate  $r$  allows lifting to a light-like coordinate of  $H$ . This is achieved if  $r$  is identified as coordinate associated with a light-like curve whose tangent at point  $x \in X_l^3$  is light-like vector in  $M^2(x) \subset T(X^4(X^3))$ . With this interpretation of SKM algebra as sub-algebra of super-symplectic algebra becomes natural.
3. The existence of a lifting of  $SS$  and  $SKM$  algebras to entire  $H$  would solve the problems. The lifting problem is obviously non-trivial only in  $M^4$  degrees of freedom. Suppose that the existence of an integrable distribution of planes  $M^2(x)$  and their orthogonal complements  $E^2(x)$  belonging

to the tangent space of  $M^4$  projection  $P_{M^4}(X^4(X^3))$  characterizes the preferred extremals with Minkowskian signature of induced metric. In this case the lifting of the super-symplectic and super Kac-Moody algebras to entire  $H$  is possible. The local degrees of freedom contributing to the configuration space metric would belong to the integrable distribution of orthogonal complements  $E^2(x)$  of  $M^2(x)$  having physical interpretation as planes of physical polarizations.

#### 4.2.8 Comparison of TGD and stringy views about super-conformal symmetries

The best manner to represent TGD based view about conformal symmetries is by comparison with the conformal symmetries of super string models.

##### Basic differences between the realization of super conformal symmetries in TGD and in super-string models

The realization super conformal symmetries in TGD framework differs from that in string models in several fundamental aspects.

1. In TGD framework super-symmetry generators acting as configuration space gamma matrices carry either lepton or quark number. Majorana condition required by the hermiticity of super generators which is crucial for super string models would be in conflict with the conservation of baryon and lepton numbers and is avoided. This is made possible by the realization of bosonic generators represented as Hamiltonians of  $X^2$ -local symplectic transformations rather than vector fields generating them [?]. This kind of representation applies also in Kac-Moody sector since the local transversal isometries localized in  $X^3$  and respecting light-likeness condition can be regarded as  $X^2$  local symplectic transformations, whose Hamiltonians generate also isometries. Localization is not complete: the functions of  $X^2$  coordinates multiplying symplectic and Kac-Moody generators are functions of the symplectic invariant  $J = \epsilon^{\mu\nu} J_{\mu\nu}$  so that effective one-dimensionality results but in different sense than in conformal field theories. This realization of super symmetries is what distinguishes between TGD and super string models and leads to a totally different physical interpretation of super-conformal symmetries. The fermionic representations of super-symplectic and super Kac-Moody generators can be identified as Noether charges in standard manner.
2. A long-standing problem of quantum TGD was that stringy propagator  $1/G$  does not make sense if  $G$  carries fermion number. The progress in the understanding of second quantization of the modified Dirac operator made it however possible to identify the counterpart of  $G$  as a c-number valued operator and interpret it as different representation of  $G$  [K17].
3. The notion of super-space is not needed at all since Hamiltonians rather than vector fields represent bosonic generators, no super-variant of geometry is needed. The distinction between Ramond and N-S representations important for  $N = 1$  super-conformal symmetry and allowing only ground state weight 0 an  $1/2$  disappears. Indeed, for  $N = 2$  super-conformal symmetry it is already possible to generate spectral flow transforming these Ramond and N-S representations to each other ( $G_n$  is not Hermitian anymore). This means that the interpretation of  $\lambda_i^2$  ( $\lambda_i$  is generalized eigenvalue of  $D_K(X^2)$ ) as ground state conformal weight does not lead to difficulties.
4. If Kähler action defines the modified Dirac operator, the number of spinor modes is finite. One must be here somewhat cautious since bound state in the Coulomb potential associated with electric part of induced electro-weak gauge field might give rise to an infinite number of bound states which eigenvalues converging to a fixed eigenvalue (as in the case of hydrogen atom). Finite number of generalized eigenmodes means that the representations of super-conformal algebras reduces to finite-dimensional ones in TGD framework. Also the notion of number theoretic braid indeed implies this. The physical interpretation is in terms of finite measurement resolution. If Kähler action is complexified to include imaginary part defined by CP breaking instanton term, the number of generalized eigenvalues becomes infinite since conformal excitations are possible. This means breakdown of exact holography and effective 2-dimensionality of 3-surfaces. It seems that the inclusion of instanton term is necessary for several reasons. The notion of finite

measurement resolution forces conformal cutoff also now. There are arguments suggesting that only the modes with vanishing conformal weight contribute to the Dirac determinant defining vacuum functional identified as exponent of Kähler function in turn identified as Kähler action for its preferred extremal.

5. What makes spinor field mode a generator of gauge super-symmetry is that is c-number and not an eigenmode of  $D_K(X^2)$  and thus represents non-dynamical degrees of freedom. If the number of eigen modes of  $D_K(X^2)$  is indeed finite means that most of spinor field modes represent super gauge degrees of freedom.

### The super generators $G$ are not Hermitian in TGD!

The already noticed important difference between TGD based and the usual Super Virasoro representations is that the Super Virasoro generator  $G$  cannot be Hermitian in TGD. The reason is that configuration space gamma matrices possess a well defined fermion number. The hermiticity of the configuration space gamma matrices  $\Gamma$  and of the Super Virasoro current  $G$  could be achieved by posing Majorana conditions on the second quantized H-spinors. Majorana conditions can be however realized only for space-time dimension  $D \bmod 8 = 2$  so that super string type approach does not work in TGD context. This kind of conditions would also lead to the non-conservation of baryon and lepton numbers.

An analogous situation is encountered in super-symmetric quantum mechanics, where the general situation corresponds to super symmetric operators  $S, S^\dagger$ , whose anti-commutator is Hamiltonian:  $\{S, S^\dagger\} = H$ . One can define a simpler system by considering a Hermitian operator  $S_0 = S + S^\dagger$  satisfying  $S_0^2 = H$ : this relation is completely analogous to the ordinary Super Virasoro relation  $GG = L$ . On basis of this observation it is clear that one should replace ordinary Super Virasoro structure  $GG = L$  with  $GG^\dagger = L$  in TGD context.

It took a long time to realize the trivial fact that  $N = 2$  super-symmetry is the standard physics counterpart for TGD super symmetry.  $N = 2$  super-symmetry indeed involves the doubling of super generators and super generators carry  $U(1)$  charge having an interpretation as fermion number in recent context. The so called short representations of  $N = 2$  super-symmetry algebra can be regarded as representations of  $N = 1$  super-symmetry algebra.

Configuration space gamma matrix  $\Gamma_n, n > 0$  corresponds to an operator creating fermion whereas  $\Gamma_n, n < 0$  annihilates antifermion. For the Hermitian conjugate  $\Gamma_n^\dagger$  the roles of fermion and antifermion are interchanged. Only the anti-commutators of gamma matrices and their Hermitian conjugates are non-vanishing. The dynamical Kac Moody type generators are Hermitian and are constructed as bilinears of the gamma matrices and their Hermitian conjugates and, just like conserved currents of the ordinary quantum theory, contain parts proportional to  $a^\dagger a, b^\dagger b, a^\dagger b^\dagger$  and  $ab$  ( $a$  and  $b$  refer to fermionic and antifermionic oscillator operators). The commutators between Kac Moody generators and Kac Moody generators and gamma matrices remain as such.

For a given value of  $m$   $G_m, m > 0$  creates fermions whereas  $G_m, m < 0$  annihilates antifermions. Analogous result holds for  $G_m^\dagger$ . Virasoro generators remain Hermitian and decompose just like Kac Moody generators do. Thus the usual anti-commutation relations for the super Virasoro generators must be replaced with anti-commutations between  $G_m$  and  $G_n^\dagger$  and one has

$$\begin{aligned} \{G_m, G_n^\dagger\} &= 2L_{m+n} + \frac{c}{3}(m^2 - \frac{1}{4})\delta_{m,-n} \quad , \\ \{G_m, G_n\} &= 0 \quad , \\ \{G_m^\dagger, G_n^\dagger\} &= 0 \quad . \end{aligned} \tag{4.2.2}$$

The commutators of type  $[L_m, L_n]$  are not changed. Same applies to the purely kinematical commutators between  $L_n$  and  $G_m/G_m^\dagger$ .

The Super Virasoro conditions satisfied by the physical states are as before in case of  $L_n$  whereas the conditions for  $G_n$  are doubled to those of  $G_n, n < 0$  and  $G_n^\dagger, n > 0$ .

### What could be the counter parts of stringy conformal fields in TGD framework?

The experience with string models would suggest the conformal symmetries associated with the complex coordinates of  $X^2$  as a candidate for conformal super-symmetries. One can imagine two counterparts of the stringy coordinate  $z$  in TGD framework.



1. Super-symplectic and super Kac-Moody symmetries are local with respect to  $X^2$  in the sense that the coefficients of generators depend on the invariant  $J = \epsilon^{\alpha\beta} J_{\alpha\beta} \sqrt{g_2}$  rather than being completely free [?]. Thus the real variable  $J$  replaces complex (or hyper-complex) stringy coordinate and effective 1-dimensionality holds true also now but in different sense than for conformal field theories.
2. The slicing of  $X^2$  by string world sheets  $Y^2$  and partonic 2-surfaces  $X^2$  implied by number theoretic compactification implies string-parton duality and involves the super conformal fermionic gauge symmetries associated with the coordinates  $u$  and  $w$  in the dual dimensional reductions to stringy and partonic dynamics. These coordinates define the natural analogs of stringy coordinate. The effective reduction of  $X_l^3$  to braid by finite measurement resolution implies the effective reduction of  $X^4(X^3)$  to string world sheet. This implies quite strong resemblance with string model and allows to understand among other things how Equivalence Principle emerges in TGD framework at space-time level from its quantum counterpart realized in terms of generalized coset representation for super-symplectic and Super Kac-Moody algebras.
3. The conformal fields of string model would reside at  $X^2$  or  $Y^2$  depending on which description one uses and complex (hyper-complex) string coordinate would be identified accordingly.  $Y^2$  could be fixed as a union of stringy world sheets having the strands of number theoretic braids as its ends. The proposed definition of braids is unique and characterizes finite measurement resolution at space-time level.  $X^2$  could be fixed uniquely as the intersection of  $X_l^3$  (the light-like 3-surface at which induced metric of space-time surface changes its signature) with  $\delta M_{\pm}^4 \times CP_2$ . Clearly, wormhole throats  $X_l^3$  would take the role of branes and would be connected by string world sheets defined by number theoretic braids.
4. An alternative identification for TGD parts of conformal fields is inspired by  $M^8 - H$  duality. Conformal fields would be fields in configuration space. The counterpart of  $z$  coordinate could be the hyper-octonionic  $M^8$  coordinate  $m$  appearing as argument in the Laurent series of configuration space Clifford algebra elements.  $m$  would characterize the position of the tip of  $CD$  and the fractal hierarchy of  $CD$ s within  $CD$ s would give a hierarchy of Clifford algebras and thus inclusions of hyper-finite factors of type  $II_1$ . Reduction to hyper-quaternionic field -that is field in  $M^4$  center of mass degrees of freedom- would be needed to obtain associativity. The arguments  $m$  at various level might correspond to arguments of N-point function in quantum field theory.

### 4.3 Number theoretic compactification and $M^8 - H$ duality

This section summarizes the basic vision about number theoretic compactification reducing the classical dynamics to number theory. In strong form  $M^8 - H$  duality boils down to the assumption that space-time surfaces can be regarded either as surfaces of  $H$  or as surfaces of  $M^8$  composed of hyper-quaternionic and co-hyper-quaternionic regions identifiable as regions of space-time possessing Minkowskian *resp.* Euclidian signature of the induced metric.

#### 4.3.1 Basic idea behind $M^8 - M^4 \times CP_2$ duality

The hopes of giving  $M^4 \times CP_2$  hyper-octonionic structure are meager. This circumstance forces to ask whether four-surfaces  $X^4 \subset M^8$  could under some conditions define 4-surfaces in  $M^4 \times CP_2$  indirectly so that the spontaneous compactification of super string models would correspond in TGD to two different manners to interpret the space-time surface. The following arguments suggest that this is indeed the case.

The hard mathematical fact behind number theoretical compactification is that the quaternionic sub-algebras of octonions with fixed complex structure (that is complex sub-space) are parameterized by  $CP_2$  just as the complex planes of quaternion space are parameterized by  $CP_1 = S^2$ . Same applies to hyper-quaternionic sub-spaces of hyper-octonions.  $SU(3)$  would thus have an interpretation as the isometry group of  $CP_2$ , as the automorphism sub-group of octonions, and as color group.

1. The space of complex structures of the octonion space is parameterized by  $S^6$ . The subgroup  $SU(3)$  of the full automorphism group  $G_2$  respects the a priori selected complex structure and

thus leaves invariant one octonionic imaginary unit, call it  $e_1$ . Hyper-quaternions can be identified as  $U(2)$  Lie-algebra but it is obvious that hyper-octonions do not allow an identification as  $SU(3)$  Lie algebra. Rather, octonions decompose as  $1 \oplus 1 \oplus 3 \oplus \bar{3}$  to the irreducible representations of  $SU(3)$ .

2. Geometrically the choice of a preferred complex (quaternionic) structure means fixing of complex (quaternionic) sub-space of octonions. The fixing of a hyper-quaternionic structure of hyper-octonionic  $M^8$  means a selection of a fixed hyper-quaternionic sub-space  $M^4 \subset M^8$  implying the decomposition  $M^8 = M^4 \times E^4$ . If  $M^8$  is identified as the tangent space of  $H = M^4 \times CP_2$ , this decomposition results naturally. It is also possible to select a fixed hyper-complex structure, which means a further decomposition  $M^4 = M^2 \times E^2$ .
3. The basic result behind number theoretic compactification and  $M^8 - H$  duality is that hyper-quaternionic sub-spaces  $M^4 \subset M^8$  containing a fixed hyper-complex sub-space  $M^2 \subset M^4$  or its light-like line  $M_{\pm}$  are parameterized by  $CP_2$ . The choices of a fixed hyper-quaternionic basis  $1, e_1, e_2, e_3$  with a fixed complex sub-space (choice of  $e_1$ ) are labeled by  $U(2) \subset SU(3)$ . The choice of  $e_2$  and  $e_3$  amounts to fixing  $e_2 \pm \sqrt{-1}e_3$ , which selects the  $U(2) = SU(2) \times U(1)$  subgroup of  $SU(3)$ .  $U(1)$  leaves 1 invariant and induced a phase multiplication of  $e_1$  and  $e_2 \pm e_3$ .  $SU(2)$  induces rotations of the spinor having  $e_2$  and  $e_3$  components. Hence all possible completions of  $1, e_1$  by adding  $e_2, e_3$  doublet are labeled by  $SU(3)/U(2) = CP_2$ .
4. Space-time surface  $X^4 \subset M^8$  is by the standard definition hyper-quaternionic if the tangent spaces of  $X^4$  are hyper-quaternionic planes. Co-hyper-quaternionicity means the same for normal spaces. The presence of fixed hyper-complex structure means at space-time level that the tangent space of  $X^4$  contains fixed  $M^2$  at each point. Under this assumption one can map the points  $(m, e) \in M^8$  to points  $(m, s) \in H$  by assigning to the point  $(m, e)$  of  $X^4$  the point  $(m, s)$ , where  $s \in CP_2$  characterize  $T(X^4)$  as hyper-quaternionic plane. This definition is not the only one and even the appropriate one in TGD context the replacement of the tangent plane with the 4-D plane spanned by modified gamma matrices defined by Kähler action is a more natural choice. This plane is not parallel to tangent plane in general. In the sequel  $T(X^4)$  denotes the preferred 4-plane which co-incides with tangent plane of  $X^4$  only if the action defining modified gamma matrices is 4-volume.
5. The choice of  $M^2$  can be made also local in the sense that one has  $T(X^4) \supset M^2(x) \subset M^4 \subset H$ . It turns out that strong form of number theoretic compactification requires this kind of generalization. In this case one must be able to fix the convention how the point of  $CP_2$  is assigned to a hyper-quaternionic plane so that it applies to all possible choices of  $M^2 \subset M^4$ . Since  $SO(3)$  hyper-quaternionic rotation relates the hyper-quaternionic planes to each other, the natural assumption is hyper-quaternionic planes related by  $SO(3)$  rotation correspond to the same point of  $CP_2$ . Under this assumption it is possible to map hyper-quaternionic surfaces of  $M^8$  for which  $M^2 \subset M^4$  depends on point of  $X^4$  to  $H$ .

### 4.3.2 Hyper-octonionic Pauli "matrices" and modified definition of hyper-quaternionicity

Hyper-octonionic Pauli matrices suggest an interesting possibility to define precisely what hyper-quaternionicity means at space-time level (for background see [?] ).

1. According to the standard definition space-time surface  $X^4$  is hyper-quaternionic if the tangent space at each point of  $X^4$  in  $X^4 \subset M^8$  picture is hyper-quaternionic. What raises worries is that this definition involves in no manner the action principle so that it is far from obvious that this identification is consistent with the vacuum degeneracy of Kähler action. It also unclear how one should formulate hyper-quaternionicity condition in  $X^4 \subset M^4 \times CP_2$  picture.
2. The idea is to map the modified gamma matrices  $\Gamma^\alpha = \frac{\partial L_K}{\partial h_k^\alpha} \Gamma^k$ ,  $\Gamma_k = e_k^A \gamma_A$ , to hyper-octonionic Pauli matrices  $\sigma^\alpha$  by replacing  $\gamma_A$  with hyper-octonion unit. Hyper-quaternionicity would state that the hyper-octonionic Pauli matrices  $\sigma^\alpha$  obtained in this manner span complexified quaternion sub-algebra at each point of space-time. These conditions would provide a number theoretic

manner to select preferred extremals of Kähler action. Remarkably, this definition applies both in case of  $M^8$  and  $M^4 \times CP_2$ .

3. Modified Pauli matrices span the tangent space of  $X^4$  if the action is four-volume because one has  $\frac{\partial L_K}{\partial h_\alpha^k} = \sqrt{g}g^{\alpha\beta}\partial h_\beta^l h_{kl}$ . Modified gamma matrices reduce to ordinary induced gamma matrices in this case: 4-volume indeed defines a super-conformally symmetric action for ordinary gamma matrices since the mass term of the Dirac action given by the trace of the second fundamental form vanishes for minimal surfaces.
4. For Kähler action the hyper-quaternionic sub-space does not coincide with the tangent space since  $\frac{\partial L_K}{\partial h_\alpha^k}$  contains besides the gravitational contribution coming from the induced metric also the "Maxwell contribution" from the induced Kähler form not parallel to space-time surface. Modified gamma matrices are required by super conformal symmetry for the extremals of Kähler action and they also guarantee that vacuum extremals defined by surfaces in  $M^4 \times Y^2$ ,  $Y^2$  a Lagrange sub-manifold of  $CP_2$ , are trivially hyper-quaternionic surfaces. The modified definition of hyper-quaternionicity does not affect in any manner  $M^8 \leftrightarrow M^4 \times CP_2$  duality allowing purely number theoretic interpretation of standard model symmetries.

A side comment not strictly related to hyper-quaternionicity is in order. The anticommutators of the modified gamma matrices define an effective Riemann metric and one can assign to it the counterparts of Riemann connection, curvature tensor, geodesic line, volume, etc... One would have two different metrics associated with the space-time surface. Only if the action defining space-time surface is identified as the volume in the ordinary metric, these metrics are equivalent. The index raising for the effective metric could be defined also by the induced metric and it is not clear whether one can define Riemann connection also in this case. Could this effective metric have concrete physical significance and play a deeper role in quantum TGD? For instance, AdS-CFT duality leads to ask whether interactions be coded in terms of the gravitation associated with the effective metric.

### 4.3.3 Minimal form of $M^8 - H$ duality

The basic problem in the construction of quantum TGD has been the identification of the preferred extremals of Kähler action playing a key role in the definition of the theory. The most elegant manner to do this is by fixing the 4-D tangent space  $T(X^4(X_i^3))$  of  $X^4(X_i^3)$  at each point of  $X_i^3$  so that the boundary value problem is well defined. What I called number theoretical compactification allows to achieve just this although I did not fully realize this in the original vision. The minimal picture is following.

1. The basic observations are following. Let  $M^8$  be endowed with hyper-octonionic structure. For hyper-quaternionic space-time surfaces in  $M^8$  tangent spaces are by definition hyper-quaternionic. If they contain a preferred plane  $M^2 \subset M^4 \subset M^8$  in their tangent space, they can be mapped to 4-surfaces in  $M^4 \times CP_2$ . The reason is that the hyper-quaternionic planes containing preferred the hyper-complex plane  $M^2$  of  $M_\pm \subset M^2$  are parameterized by points of  $CP_2$ . The map is simply  $(m, e) \rightarrow (m, s(m, e))$ , where  $m$  is point of  $M^4$ ,  $e$  is point of  $E^4$ , and  $s(m, 2)$  is point of  $CP_2$  representing the hyperquaternionic plane. The inverse map assigns to each point  $(m, s)$  in  $M^4 \times CP_2$  point  $m$  of  $M^4$ , undetermined point  $e$  of  $E^4$  and 4-D plane. The requirement that the distribution of planes containing the preferred  $M^2$  or  $M_\pm$  corresponds to a distribution of planes for 4-D surface is expected to fix the points  $e$ . The physical interpretation of  $M^2$  is in terms of plane of non-physical polarizations so that gauge conditions have purely number theoretical interpretation.
2. In principle, the condition that  $T(X^4)$  contains  $M^2$  can be replaced with a weaker condition that either of the two light-like vectors of  $M^2$  is contained in it since already this condition assigns to  $T(X^4)$   $M^2$  and the map  $H \rightarrow M^8$  becomes possible. Only this weaker form applies in the case of massless extremals [K9] as will be found.
3. The original idea was that hyper-quaternionic 4-surfaces in  $M^8$  containing  $M^2 \subset M^4$  in their tangent space could correspond to preferred extremals of Kähler action. This condition does not seem to be consistent with what is known about the extremals of Kähler action. The weaker form of the hypothesis is that hyper-quaternionicity holds only for 4-D tangent spaces

of  $X_l^3 \subset H = M^4 \times CP_2$  identified as wormhole throats or boundary components lifted to 3-surfaces in 8-D tangent space  $M^8$  of  $H$ . The minimal hypothesis would be that only  $T(X^4(X_l^3))$  at  $X_l^3$  is associative that is hyper-quaternionic for fixed  $M^2$ .  $X_l^3 \subset M^8$  and  $T(X^4(X_l^3))$  at  $X_l^3$  can be mapped to  $X_l^3 \subset H$  if tangent space contains also  $M_\pm \subset M^2$  or  $M^2 \subset M^4 \subset M^8$  itself having interpretation as preferred hyper-complex plane. This condition is not satisfied by all surfaces  $X_l^3$  as is clear from the fact that the inverse map involves local  $E^4$  translation. The requirements that the distribution of hyper-quaternionic planes containing  $M^2$  corresponds to a distribution of 4-D tangent planes should fix the  $E^4$  translation to a high degree.

4. A natural requirement is that the image of  $X_l^3 \subset H$  in  $M^8$  is light-like. The condition that the determinant of induced metric vanishes gives an additional condition reducing the number of free parameters by one. This condition cannot be formulated as a condition on  $CP_2$  coordinate characterizing the hyper-quaternionic plane. Since  $M^4$  projections are same for the two representations, this condition is satisfied if the contributions from  $CP_2$  and  $E^4$  and projections to the induced metric are identical:  $s_{kl}\partial_\alpha s^k \partial_\beta s^l = e_{kl}\partial_\alpha e^k \partial_\beta e^l$ . This condition means that only a subset of light-like surfaces of  $M^8$  are realized physically. One might argue that this is as it must be since the volume of  $E^4$  is infinite and that of  $CP_2$  finite: only an infinitesimal portion of all possible light-like 3-surfaces in  $M^8$  can have  $H$  counterparts. The conclusion would be that number theoretical compactification is 4-D isometry between  $X^4 \subset H$  and  $X^4 \subset M^8$  at  $X_l^3$ . This unproven conjecture is unavoidable.
5.  $M^2 \subset T(X^4(X_l^3))$  condition fixes  $T(X^4(X_l^3))$  in the generic case by extending the tangent space of  $X_l^3$ , and the construction of configuration space spinor structure fixes boundary conditions completely by additional conditions necessary when  $X_l^3$  corresponds to a light-like 3 surfaces defining wormhole throat at which the signature of induced metric changes. What is especially beautiful that only the data in  $T(X^4(X_l^3))$  at  $X_l^3$  is needed to calculate the vacuum functional of the theory as Dirac determinant: the only remaining conjecture (strictly speaking un-necessary but realistic looking) is that this determinant gives exponent of Kähler action for the preferred extremal and there are excellent hopes for this by the structure of the basic construction.

The basic criticism relates to the condition that light-like 3-surfaces are mapped to light-like 3-surfaces guaranteed by the condition that  $M^8 - H$  duality is isometry at  $X_l^3$ .

#### 4.3.4 Strong form of $M^8 - H$ duality

The proposed picture is the minimal one. One can of course ask whether the original much stronger conjecture that the preferred extrema of Kähler action correspond to hyper-quaternionic surfaces could make sense in some form. One can also wonder whether one could allow the choice of the plane  $M^2$  of non-physical polarization to be local so that one would have  $M^2(x) \subset M^4 \subset M^4 \times E^4$ , where  $M^4$  is fixed hyper-quaternionic sub-space of  $M^8$  and identifiable as  $M^4$  factor of  $H$ .

1. If  $M^2$  is same for all points of  $X_l^3$ , the inverse map  $X_l^3 \subset H \rightarrow X_l^3 \subset M^8$  is fixed apart from possible non-uniqueness related to the local translation in  $E^4$  from the condition that hyper-quaternionic planes represent light-like tangent 4-planes of light-like 3-surfaces. The question is whether not only  $X_l^3$  but entire four-surface  $X^4(X_l^3)$  could be mapped to the tangent space of  $M^8$ . By selecting suitably the local  $E^4$  translation one might hope of achieving the achieving this. The conjecture would be that the preferred extrema of Kähler action are those for which the distribution integrates to a distribution of tangent planes.
2. There is however a problem. What is known about extremals of Kähler action is not consistent with the assumption that fixed  $M^2$  of  $M_\pm \subset M^2$  is contained in the tangent space of  $X^4$ . This suggests that one should relax the condition that  $M^2 \subset M^4 \subset M^8$  is a fixed hyper-complex plane associated with the tangent space or normal space  $X^4$  and allow  $M^2$  to vary from point to point so that one would have  $M^2 = M^2(x)$ . In  $M^8 \rightarrow H$  direction the justification comes from the observation (to be discussed below) that it is possible to uniquely fix the convention assigning  $CP_2$  point to a hyper-quaternionic plane containing varying hyper-complex plane  $M^2(x) \subset M^4$ . Number theoretic compactification fixes naturally  $M^4 \subset M^8$  so that it applies to any  $M^2(x) \subset M^4$ . Under this condition the selection is parameterized by an element of  $SO(3)/SO(2) = S^2$ .

Note that  $M^4$  projection of  $X^4$  would be at least 2-dimensional in hyper-quaternionic case. In co-hyper-quaternionic case  $E^4$  projection would be at least 2-D.  $SO(2)$  would act as a number theoretic gauge symmetry and the  $SO(3)$  valued chiral field would approach to constant at  $X_l^3$  invariant under global  $SO(2)$  in the case that one keeps the assumption that  $M^2$  is fixed ad  $X_l^3$ .

3. This picture requires a generalization of the map assigning to hyper-quaternionic plane a point of  $CP_2$  so that this map is defined for all possible choices of  $M^2 \subset M^4$ . Since the  $SO(3)$  rotation of the hyper-quaternionic unit defining  $M^2$  rotates different choices parameterized by  $S^2$  to each other, a natural assumption is that the hyper-quaternionic planes related by  $SO(3)$  rotation correspond to the same point of  $CP_2$ . Denoting by  $M^2$  the standard representative of  $M^2$ , this means that for the map  $M^8 \rightarrow H$  one must perform  $SO(3)$  rotation of hyper-quaternionic plane taking  $M^2(x)$  to  $M^2$  and map the rotated plane to  $CP_2$  point. In  $M^8 \rightarrow H$  case one must first map the point of  $CP_2$  to hyper-quaternionic plane and rotate this plane by a rotation taking  $M^2(x)$  to  $M^2$ .
4. In this framework local  $M^2$  can vary also at the surfaces  $X_l^3$ , which considerably relaxes the boundary conditions at wormhole throats and light-like boundaries and allows much more general variety of light-like 3-surfaces since the basic requirement is that  $M^4$  projection is at least 1-dimensional. The physical interpretation would be that a local choice of the plane of non-physical polarizations is possible everywhere in  $X^4(X_l^3)$ . This does not seem to be in any obvious conflict with physical intuition.

These observation provide support for the conjecture that (classical)  $S^2 = SO(3)/SO(2)$  conformal field theory might be relevant for (classical) TGD.

1. General coordinate invariance suggests that the theory should allow a formulation using any light-like 3-surface  $X^3$  inside  $X^4(X_l^3)$  besides  $X_l^3$  identified as union of wormhole throats and boundary components. For these surfaces the element  $g(x) \in SO(3)$  would vary also at partonic 2-surfaces  $X^2$  defined as intersections of  $\delta CD \times CP_2$  and  $X^3$  (here  $CD$  denotes causal diamond defined as intersection of future and past directed light-cones). Hence one could have  $S^2 = SO(3)/SO(2)$  conformal field theory at  $X^2$  (regarded as quantum fluctuating so that also  $g(x)$  varies) generalizing to WZW model for light-like surfaces  $X^3$ .
2. The presence of  $E^4$  factor would extend this theory to a classical  $E^4 \times S^2$  WZW model bringing in mind string model with 6-D Euclidian target space extended to a model of light-like 3-surfaces. A further extension to  $X^4$  would be needed to integrate the WZW models associated with 3-surfaces to a full 4-D description. General Coordinate Invariance however suggests that  $X_l^3$  description is enough for practical purposes.
3. The choices of  $M^2(x)$  in the interior of  $X_l^3$  is dictated by dynamics and the first optimistic conjecture is that a classical solution of  $SO(3)/SO(2)$  Wess-Zumino-Witten model obtained by coupling  $SO(3)$  valued field to a covariantly constant  $SO(2)$  gauge potential characterizes the choice of  $M^2(x)$  in the interior of  $M^8 \supset X^4(X_l^3) \subset H$  and thus also partially the structure of the preferred extremal. Second optimistic conjecture is that the Kähler action involving also  $E^4$  degrees of freedom allows to assign light-like 3-surface to light-like 3-surface.
4. The best that one can hope is that  $M^8 - H$  duality could allow to transform the extremely non-linear classical dynamics of TGD to a generalization of WZW-type model. The basic problem is to understand how to characterize the dynamics of  $CP_2$  projection at each point.

In  $H$  picture there are two basic types of vacuum extremals:  $CP_2$  type extremals representing elementary particles and vacuum extremals having  $CP_2$  projection which is at most 2-dimensional Lagrange manifold and representing say hadron. Vacuum extremals can appear only as limiting cases of preferred extremals which are non-vacuum extremals. Since vacuum extremals have so decisive role in TGD, it is natural to requires that this notion makes sense also in  $M^8$  picture. In particular, the notion of vacuum extremal makes sense in  $M^8$ .

This requires that Kähler form exist in  $M^8$ .  $E^4$  indeed allows full  $S^2$  of covariantly constant Kähler forms representing quaternionic imaginary units so that one can identify Kähler form and construct Kähler action. The obvious conjecture is that hyper-quaternionic space-time surface is extremal of

this Kähler action and that the values of Kähler actions in  $M^8$  and  $H$  are identical. The elegant manner to achieve this, as well as the mapping of vacuum extremals to vacuum extremals and the mapping of light-like 3-surfaces to light-like 3-surfaces is to assume that  $M^8 - H$  duality is Kähler isometry so that induced Kähler forms are identical.

This picture contains many speculative elements and some words of warning are in order.

1. Light-likeness conjecture would boil down to the hypothesis that  $M^8 - H$  correspondence is Kähler isometry so that the metric and Kähler form of  $X^4$  induced from  $M^8$  and  $H$  would be identical. This would guarantee also that Kähler actions for the preferred extremal are identical. This conjecture is beautiful but strong.
2. The slicing of  $X^4(X_l^3)$  by light-like 3-surfaces is very strong condition on the classical dynamics of Kähler action and does not make sense for pieces of  $CP_2$  type vacuum extremals.

### Minkowskian-Euclidian $\leftrightarrow$ associative-co-associative

The 8-dimensionality of  $M^8$  allows to consider both associativity (hyper-quaternionicity) of the tangent space and associativity of the normal space- let us call this co-associativity of tangent space- as alternative options. Both options are needed as has been already found. Since space-time surface decomposes into regions whose induced metric possesses either Minkowskian or Euclidian signature, there is a strong temptation to propose that Minkowskian regions correspond to associative and Euclidian regions to co-associative regions so that space-time itself would provide both the description and its dual.

The proposed interpretation of conjectured associative-co-associative duality relates in an interesting manner to p-adic length scale hypothesis selecting the primes  $p \simeq 2^k$ ,  $k$  positive integer as preferred p-adic length scales.  $L_p \propto \sqrt{p}$  corresponds to the p-adic length scale defining the size of the space-time sheet at which elementary particle represented as  $CP_2$  type extremal is topologically condensed and is of order Compton length.  $L_k \propto \sqrt{k}$  represents the p-adic length scale of the worm-hole contacts associated with the  $CP_2$  type extremal and  $CP_2$  size is the natural length unit now. Obviously the quantitative formulation for associative-co-associative duality would be in terms  $p \rightarrow k$  duality.

### Are the known extremals of Kähler action consistent with the strong form of $M^8 - H$ duality

It is interesting to check whether the known extremals of Kähler action [K9] are consistent with strong form of  $M^8 - H$  duality assuming that  $M^2$  or its light-like ray is contained in  $T(X^4)$  or normal space.

1.  $CP_2$  type vacuum extremals correspond cannot be hyper-quaternionic surfaces but co-hyper-quaternionicity is natural for them. In the same manner canonically imbedded  $M^4$  can be only hyper-quaternionic.
2. String like objects are associative since tangent space obviously contains  $M^2(x)$ . Objects of form  $M^1 \times X^3 \subset M^4 \times CP_2$  do not have  $M^2$  either in their tangent space or normal space in  $H$ . So that the map from  $H \rightarrow M^8$  is not well defined. There are no known extremals of Kähler action of this type. The replacement of  $M^1$  random light-like curve however gives vacuum extremal with vanishing volume, which need not mean physical triviality since fundamental objects of the theory are light-like 3-surfaces.
3. For canonically imbedded  $CP_2$  the assignment of  $M^2(x)$  to normal space is possible but the choice of  $M^2(x) \subset N(CP_2)$  is completely arbitrary. For a generic  $CP_2$  type vacuum extremals  $M^4$  projection is a random light-like curve in  $M^4 = M^1 \times E^3$  and  $M^2(x)$  can be defined uniquely by the normal vector  $n \in E^3$  for the local plane defined by the tangent vector  $dx^\mu/dt$  and acceleration vector  $d^2x^\mu/dt^2$  assignable to the orbit.
4. Consider next massless extremals. Let us fix the coordinates of  $X^4$  as  $(t, z, x, y) = (m^0, m^2, m^1, m^2)$ . For simplest massless extremals  $CP_2$  coordinates are arbitrary functions of variables  $u = k \cdot m = t - z$  and  $v = \epsilon \cdot m = x$ , where  $k = (1, 1, 0, 0)$  is light-like vector of  $M^4$  and  $\epsilon = (0, 0, 1, 0)$  a polarization vector orthogonal to it. Obviously, the extremals defines a decomposition  $M^4 = M^2 \times E^2$ .

Tangent space is spanned by the four  $H$ -vectors  $\nabla_\alpha h^k$  with  $M^4$  part given by  $\nabla_\alpha m^k = \delta_\alpha^k$  and  $CP_2$  part by  $\nabla_\alpha s^k = \partial_u s^k k_\alpha + \partial_v s^k \epsilon_\alpha$ .

The normal space cannot contain  $M^4$  vectors since the  $M^4$  projection of the extremal is  $M^4$ . To realize hyper-quaternionic representation one should be able to from these vector two vectors of  $M^2$ , which means linear combinations of tangent vectors for which  $CP_2$  part vanishes. The vector  $\partial_t h^k - \partial_z h^k$  has vanishing  $CP_2$  part and corresponds to  $M^4$  vector  $(1, -1, 0, 0)$  fix assigns to each point the plane  $M^2$ . To obtain  $M^2$  one would need  $(1, 1, 0, 0)$  too but this is not possible. The vector  $\partial_y h^k$  is  $M^4$  vector orthogonal to  $\epsilon$  but  $M^2$  would require also  $(1, 0, 0, 0)$ . The proposed generalization of massless extremals allows the light-like line  $M_\pm$  to depend on point of  $M^4$  [K9], and leads to the introduction of Hamilton-Jacobi coordinates involving a local decomposition of  $M^4$  to  $M^2(x)$  and its orthogonal complement with light-like coordinate lines having interpretation as curved light rays.  $M^2(x) \subset T(X^4)$  assumption fails also for vacuum extremals of form  $X^1 \times X^3 \subset M^4 \times CP_2$ , where  $X^1$  is light-like random curve. In the latter case, vacuum property follows from the vanishing of the determinant of the induced metric.

5. The deformations of string like objects to magnetic flux quanta are basic conjectural extremals of Kähler action and the proposed picture supports this conjecture. In hyper-quaternionic case the assumption that local 4-D plane of  $X^3$  defined by modified gamma matrices contains  $M^2(x)$  but that  $T(X^3)$  does not contain it, is very strong. It states that  $T(X^4)$  at each point can be regarded as a product  $M^2(x) \times T^2$ ,  $T^2 \subset T(CP_2)$ , so that hyper-quaternionic  $X^4$  would be a collection of Cartesian products of infinitesimal 2-D planes  $M^2(x) \subset M^4$  and  $T^2(x) \subset CP_2$ . The extremals in question could be seen as local variants of string like objects  $X^2 \times Y^2 \subset M^4 \times CP_2$ , where  $X^2$  is minimal surface and  $Y^2$  holomorphic surface of  $CP_2$ . One can say that  $X^2$  is replaced by a collection of infinitesimal pieces of  $M^2(x)$  and  $Y^2$  with similar pieces of homologically non-trivial geodesic sphere  $S^2(x)$  of  $CP_2$ , and the Cartesian products of these pieces are glued together to form a continuous surface defining an extremal of Kähler action. Field equations would pose conditions on how  $M^2(x)$  and  $S^2(x)$  can depend on  $x$ . This description applies to magnetic flux quanta, which are the most important must-be extremals of Kähler action.

### Geometric interpretation of strong $M^8 - H$ duality

In the proposed framework  $M^8 - H$  duality would have a purely geometric meaning and there would nothing magical in it.

1.  $X^4(X_l^3) \subset H$  could be seen a curve representing the orbit of a light-like 3-surface defining a 4-D surface. The question is how to determine the notion of tangent vector for the orbit of  $X_l^3$ . Intuitively tangent vector is a one-dimensional arrow tangential to the curve at point  $X_l^3$ . The identification of the hyper-quaternionic surface  $X^4(X_l^3) \subset M^8$  as tangent vector conforms with this intuition.
2. One could argue that  $M^8$  representation of space-time surface is kind of chart of the real space-time surface obtained by replacing real curve by its tangent line. If so, one cannot avoid the question under which conditions this kind of chart is faithful. An alternative interpretation is that a representation making possible to realize number theoretical universality is in question.
3. An interesting question is whether  $X^4(X_l^3)$  as orbit of light-like 3-surface is analogous to a geodesic line -possibly light-like- so that its tangent vector would be parallel translated in the sense that  $X^4(X^3)$  for any light-like surface at the orbit is same as  $X^4(X_l^3)$ . This would give justification for the possibility to interpret space-time surfaces as a geodesic of configuration space: this is one of the first -and practically forgotten- speculations inspired by the construction of configuration space geometry. The light-likeness of the geodesic could correspond at the level of  $X^4$  the possibility to decompose the tangent space to a direct sum of two light-like spaces and 2-D transversal space producing the foliation of  $X^4$  to light-like 3-surfaces  $X_l^3$  along light-like curves.
4.  $M^8 - H$  duality would assign to  $X_l^3$  classical orbit and its tangent vector at  $X_l^3$  as a generalization of Bohr orbit. This picture differs from the wave particle duality of wave mechanics stating that

once the position of particle is known its momentum is completely unknown. The outcome is however the same: for  $X_l^3$  corresponding to wormhole throats and light-like boundaries of  $X^4$ , canonical momentum densities in the normal direction vanish identically by conservation laws and one can say that the the analog of  $(q, p)$  phase space as the space carrying wave functions is replaced with the analog of subspace consisting of points  $(q, 0)$ . The dual description in  $M^8$  would not be analogous to wave functions in momentum space space but to those in the space of unique tangents of curves at their initial points.

### The Kähler and spinor structures of $M^8$

If one introduces  $M^8$  as dual of  $H$ , one cannot avoid the idea that hyper-quaternionic surfaces obtained as images of the preferred extremals of Kähler action in  $H$  are also extremals of  $M^8$  Kähler action with same value of Kähler action. As found, this leads to the conclusion that the  $M^8 - H$  duality is Kähler isometry. Coupling of spinors to Kähler potential is the next step and this in turn leads to the introduction of spinor structure so that quantum TGD in  $H$  should have full  $M^8$  dual.

There are strong physical constraints on  $M^8$  dual and they could kill the hypothesis. The basic constraint to the spinor structure of  $M^8$  is that it reproduces basic facts about electro-weak interactions. This includes neutral electro-weak couplings to quarks and leptons identified as different  $H$ -chiralities and parity breaking.

1. By the flatness of the metric of  $E^4$  its spinor connection is trivial.  $E^4$  however allows full  $S^2$  of covariantly constant Kähler forms so that one can accommodate free independent Abelian gauge fields assuming that the independent gauge fields are orthogonal to each other when interpreted as realizations of quaternionic imaginary units.
2. One should be able to distinguish between quarks and leptons also in  $M^8$ , which suggests that one introduce spinor structure and Kähler structure in  $E^4$ . The Kähler structure of  $E^4$  is unique apart from  $SO(3)$  rotation since all three quaternionic imaginary units and the unit vectors formed from them allow a representation as an antisymmetric tensor. Hence one must select one preferred Kähler structure, that is fix a point of  $S^2$  representing the selected imaginary unit. It is natural to assume different couplings of the Kähler gauge potential to spinor chiralities representing quarks and leptons: these couplings can be assumed to be same as in case of  $H$ .
3. Electro-weak gauge potential has vectorial and axial parts. Em part is vectorial involving coupling to Kähler form and  $Z^0$  contains both axial and vector parts. The free Kähler forms could thus allow to produce  $M^8$  counterparts of these gauge potentials possessing same couplings as their  $H$  counterparts. This picture would produce parity breaking in  $M^8$  picture correctly.
4. Only the charged parts of classical electro-weak gauge fields would be absent. This would conform with the standard thinking that charged classical fields are not important. The predicted classical  $W$  fields is one of the basic distinctions between TGD and standard model and in this framework. A further prediction is that this distinction becomes visible only in situations, where  $H$  picture is necessary. This is the case at high energies, where the description of quarks in terms of  $SU(3)$  color is convenient whereas  $SO(4)$  QCD would require large number of  $E^4$  partial waves. At low energies large number of  $SU(3)$  color partial waves are needed and the convenient description would be in terms of  $SO(4)$  QCD. Proton spin crisis might relate to this.
5. Also super-symmetries of quantum TGD crucial for the construction of configuration space geometry force this picture. In the absence of coupling to Kähler gauge potential all constant spinor fields and their conjugates would generate super-symmetries so that  $M^8$  would allow  $N = 8$  super-symmetry. The introduction of the coupling to Kähler gauge potential in turn means that all covariantly constant spinor fields are lost. Only the representation of all three neutral parts of electro-weak gauge potentials in terms of three independent Kähler gauge potentials allows right-handed neutrino as the only super-symmetry generator as in the case of  $H$ .
6. The  $SO(3)$  element characterizing  $M^2(x)$  is fixed apart from a local  $SO(2)$  transformation, which suggests an additional  $U(1)$  gauge field associated with  $SO(2)$  gauge invariance and representable as Kähler form corresponding to a quaternionic unit of  $E^4$ . A possible identification of this gauge field would be as a part of electro-weak gauge field.



**$M^8$  dual of configuration space geometry and spinor structure?**

If one introduces  $M^8$  spinor structure and preferred extremals of  $M^8$  Kähler action, one cannot avoid the question whether it is possible or useful to formulate the notion of configuration space geometry and spinor structure for light-like 3-surfaces in  $M^8$  using the exponent of Kähler action as vacuum functional.

1. The isometries of the configuration space in  $M^8$  and  $H$  formulations would correspond to symplectic transformation of  $\delta M_{\pm}^4 \times E^4$  and  $\delta M_{\pm}^4 \times CP_2$  and the Hamiltonians involved would belong to the representations of  $SO(4)$  and  $SU(3)$  with 2-dimensional Cartan sub-algebras. In  $H$  picture color group would be the familiar  $SU(3)$  but in  $M^8$  picture it would be  $SO(4)$ . Color confinement in both  $SU(3)$  and  $SO(4)$  sense could allow these two pictures without any inconsistency.
2. For  $M^4 \times CP_2$  the two spin states of covariantly constant right handed neutrino and antineutrino spinors generate super-symmetries. This super-symmetry plays an important role in the proposed construction of configuration space geometry. As found, this symmetry would be present also in  $M^8$  formulation so that the construction of  $M^8$  geometry should reduce more or less to the replacement of  $CP_2$  Hamiltonians in representations of  $SU(3)$  with  $E^4$  Hamiltonians in representations of  $SO(4)$ . These Hamiltonians can be taken to be proportional to functions of  $E^4$  radius which is  $SO(4)$  invariant and these functions bring in additional degree of freedom.
3. The construction of Dirac determinant identified as a vacuum functional can be done also in  $M^8$  picture and the conjecture is that the result is same as in the case of  $H$ . In this framework the construction is much simpler due to the flatness of  $E^4$ . In particular, the generalized eigenmodes of the Dirac operator  $D_K(Y_l^3)$  restricted to the  $X_l^3$  correspond to a situation in which one has fermion in induced Maxwell field mimicking the neutral part of electro-weak gauge field in  $H$  as far as couplings are considered. Induced Kähler field would be same as in  $H$ . Eigenmodes are localized to regions inside which the Kähler magnetic field is non-vanishing and apart from the fact that the metric is the effective metric defined in terms of canonical momentum densities via the formula  $\hat{\Gamma}^\alpha = \partial L_K / \partial h_\alpha^k \Gamma_k$  for effective gamma matrices. This in fact, forces the localization of modes implying that their number is finite so that Dirac determinant is a product over finite number eigenvalues. It is clear that  $M^8$  picture could dramatically simplify the construction of configuration space geometry.
4. The eigenvalue spectra of the transversal parts of  $D_K$  operators in  $M^8$  and  $H$  should be identical. This motivates the question whether it is possible to achieve a complete correspondence between  $H$  and  $M^8$  pictures also at the level of spinor fields at  $X^3$  by performing a gauge transformation eliminating the classical  $W$  gauge boson field altogether at  $X_l^3$  and whether this allows to transform the modified Dirac equation in  $H$  to that in  $M^8$  when restricted to  $X_l^3$ . That something like this might be achieved is supported by the fact that in Coulombic gauge the component of gauge potential in the light-like direction vanishes so that the situation is effectively 2-dimensional and holonomy group is Abelian.

**Why  $M^8 - H$  duality is useful?**

Skeptics could of course argue that  $M^8 - H$  duality produces only an inflation of unproven conjectures. There are however strong reasons for  $M^8 - H$  duality: both theoretical and physical.

1. The map of  $X_l^3 \subset H \rightarrow X_l^3 \subset M^8$  and corresponding map of space-time surfaces would allow to realize number theoretical universality.  $M^8 = M^4 \times E^4$  allows linear coordinates as natural coordinates in which one can say what it means that the point of imbedding space is rational/algebraic. The point of  $X^4 \subset H$  is algebraic if it is mapped to an algebraic point of  $M^8$  in number theoretic compactification. This of course restricts the symmetry groups to their rational/algebraic variants but this does not have practical meaning. Number theoretical compactification could in fact be motivated by the number theoretical universality.
2.  $M^8 - H$  duality could provide much simpler description of preferred extremals of Kähler action since the Kähler form in  $E^4$  has constant components. If the spinor connection in  $E^4$  is combination of the three Kähler forms mimicking neutral part of electro-weak gauge potential, the

eigenvalue spectrum for the modified Dirac operator would correspond to that for a fermion in  $U(1)$  magnetic field defined by an Abelian magnetic field whereas in  $M^4 \times CP_2$  picture  $U(2)_{ew}$  magnetic fields would be present.

3.  $M^8 - H$  duality provides insights to low energy hadron physics.  $M^8$  description might work when  $H$ -description fails. For instance, perturbative QCD which corresponds to  $H$ -description fails at low energies whereas  $M^8$  description might become perturbative description at this limit. Strong  $SO(4) = SU(2)_L \times SU(2)_R$  invariance is the basic symmetry of the phenomenological low energy hadron models based on conserved vector current hypothesis (CVC) and partially conserved axial current hypothesis (PCAC). Strong  $SO(4) = SU(2)_L \times SU(2)_R$  relates closely also to electro-weak gauge group  $SU(2)_L \times U(1)$  and this connection is not well understood in QCD description.  $M^8 - H$  duality could provide this connection. Strong  $SO(4)$  symmetry would emerge as a low energy dual of the color symmetry. Orbital  $SO(4)$  would correspond to strong  $SU(2)_L \times SU(2)_R$  and by flatness of  $E^4$  spin like  $SO(4)$  would correspond to electro-weak group  $SU(2)_L \times U(1)_R \subset SO(4)$ . Note that the inclusion of coupling to Kähler gauge potential is necessary to achieve respectable spinor structure in  $CP_2$ . One could say that the orbital angular momentum in  $SO(4)$  corresponds to strong isospin and spin part of angular momentum to the weak isospin.

### 4.3.5 $M^8 - H$ duality and low energy hadron physics

The description of  $M^8 - H$  at the configuration space level can be applied to gain a view about color confinement and its dual for electro-weak interactions at short distance limit. The basic idea is that  $SO(4)$  and  $SU(3)$  provide provide dual descriptions of quark color using  $E^4$  and  $CP_2$  partial waves and low energy hadron physics corresponds to a situation in which  $M^8$  picture provides the perturbative approach whereas  $H$  picture works at high energies. The basic prediction is that  $SO(4)$  should appear as dynamical symmetry group of low energy hadron physics and this is indeed the case.

Consider color confinement at the long length scale limit in terms of  $M^8 - H$  duality.

1. At high energy limit only lowest color triplet color partial waves for quarks dominate so that QCD description becomes appropriate whereas very higher color partial waves for quarks and gluons are expected to appear at the confinement limit. Since configuration space degrees of freedom begin to dominate, color confinement limit transcends the descriptive power of QCD.
2. The success of  $SO(4)$  sigma model in the description of low lying hadrons would directly relate to the fact that this group labels also the  $E^4$  Hamiltonians in  $M^8$  picture. Strong  $SO(4)$  quantum numbers can be identified as orbital counterparts of right and left handed electro-weak isospin coinciding with strong isospin for lowest quarks. In sigma model pion and sigma boson form the components of  $E^4$  valued vector field or equivalently collection of four  $E^4$  Hamiltonians corresponding to spherical  $E^4$  coordinates. Pion corresponds to  $S^3$  valued unit vector field with charge states of pion identifiable as three Hamiltonians defined by the coordinate components. Sigma is mapped to the Hamiltonian defined by the  $E^4$  radial coordinate. Excited mesons corresponding to more complex Hamiltonians are predicted.
3. The generalization of sigma model would assign to quarks  $E^4$  partial waves belonging to the representations of  $SO(4)$ . The model would involve also 6  $SO(4)$  gluons and their  $SO(4)$  partial waves. At the low energy limit only lowest representations would be important whereas at higher energies higher partial waves would be excited and the description based on  $CP_2$  partial waves would become more appropriate.
4. The low energy quark model would rely on quarks moving  $SO(4)$  color partial waves. Left *resp.* right handed quarks could correspond to  $SU(2)_L$  *resp.*  $SU(2)_R$  triplets so that spin statistics problem would be solved in the same manner as in the standard quark model.
5. Family replication phenomenon is described in TGD framework the same manner in both cases so that quantum numbers like strangeness and charm are not fundamental. Indeed, p-adic mass calculations allowing fractally scaled up versions of various quarks allow to replace Gell-Mann mass formula with highly successful predictions for hadron masses [K46] .

To my opinion these observations are intriguing enough to motivate a concrete attempt to construct low energy hadron physics in terms of  $SO(4)$  gauge theory.

### 4.3.6 The notion of number theoretical braid

Braids -not necessary number theoretical- provide a realization discretization as a space-time correlate for the finite measurement resolution. The notion of braid was inspired by the idea about quantum TGD as almost topological quantum field theory. Although the original form of this idea has been buried, the notion of braid has survived: in the decomposition of space-time sheets to string world sheets, the ends of strings define representatives for braid strands at light-like 3-surfaces.

The notion of number theoretic universality inspired the much more restrictive notion of number theoretic braid requiring that the points in the intersection of the braid with the partonic 2-surface correspond to rational or at most algebraic points of  $H$  in preferred coordinates fixed by symmetry considerations. The challenge has been to find a unique identification of the number theoretic braid or at least of the end points of the braid. The following consideration suggest that the number theoretic braids are not a useful notion in the generic case but make sense and are needed in the intersection of real and p-adic worlds which is in crucial role in TGD based vision about living matter [K42] .

It is only the braiding that matters in topological quantum field theories used to classify braids. Hence braid should require only the fixing of the end points of the braids at the intersection of the braid at the light-like boundaries of  $CD$ s and the braiding equivalence class of the braid itself. Therefore it is enough is to specify the topology of the braid and the end points of the braid in accordance with the attribute "number theoretic". Of course, the condition that all points of the strand of the number theoretic braid are algebraic is impossible to satisfy.

The situation in which the equations defining  $X^2$  make sense both in real sense and p-adic sense using appropriate algebraic extension of p-adic number field is central in the TGD based vision about living matter [K42] . The reason is that in this case the notion of number entanglement theoretic entropy having negative values makes sense and entanglement becomes information carrying. This motivates the identification of life as something in the intersection of real and p-adic worlds. In this situation the identification of the ends of the number theoretic braid as points belonging to the intersection of real and p-adic worlds is natural. These points -call them briefly algebraic points- belong to the algebraic extension of rationals needed to define the algebraic extension of p-adic numbers. This definition however makes sense also when the equations defining the partonic 2-surfaces fail to make sense in both real and p-adic sense. In the generic case the set of points satisfying the conditions is discrete. For instance, according to Fermat's theorem the set of rational points satisfying  $X^n + Y^n = Z^n$  reduces to the point  $(0,0,0)$  for  $n = 3, 4, \dots$ . Hence the constraint might be quite enough in the intersection of real and p-adic worlds where the choice of the algebraic extension is unique.

One can however criticize this proposal.

1. One must fix the the number of points of the braid and outside the intersection and the non-uniqueness of the algebraic extension makes the situation problematic. Physical intuition suggests that the points of braid define carriers of quantum numbers assignable to second quantized induced spinor fields so that the total number of fermions antifermions would define the number of braids. In the intersection the highly non-trivial implication is that this number cannot exceed the number of algebraic points.
2. In the generic case one expects that even the smallest deformation of the partonic 2-surface can change the number of algebraic points and also the character of the algebraic extension of rational numbers needed. The restriction to rational points is not expected to help in the generic case. If the notion of number theoretical braid is meant to be practical, must be able to decompose WCW to open sets inside which the numbers of algebraic points of braid at its ends are constant. For real topology this is expected to be impossible and it does not make sense to use p-adic topology for WCW whose points do not allow interpretation as p-adic partonic surfaces.
3. In the intersection of real and p-adic worlds which corresponds to a discrete subset of WCW, the situation is different. Since the coefficients of polynomials involved with the definition of

the partonic 2-surface must be rational or at most algebraic, continuous deformations are not possible so that one avoids the problem.

4. This forces to ask the reason why for the number theoretic braids. In the generic case they seem to produce only troubles. In the intersection of real and p-adic worlds they could however allow the construction of the elements of  $M$ -matrix describing quantum transitions changing p-adic to real surfaces and vice versa as realizations of intentions and generation of cognitions. In this the case it is natural that only the data from the intersection of the two worlds are used. In [K42] I have sketched the idea about number theoretic quantum field theory as a description of intentional action and cognition.

There is also the the problem of fixing the interior points of the braid modulo deformations not affecting the topology of the braid.

1. Infinite number of non-equivalent braidings are possible. Should one allow all possible braidings for a fixed light-like 3-surface and say that their existence is what makes the dynamics essentially three-dimensional even in the topological sense? In this case there would be no problems with the condition that the points at both ends of braid are algebraic.
2. Or should one try to characterize the braiding uniquely for a given partonic 2-surfaces and corresponding 4-D tangent space distributions? The slicing of the space-time sheet by partonic 2-surfaces and string world sheets suggests that the ends of string world sheets could define the braid strands in the generic context when there is no algebraicity condition involved. This could be taken as a very natural manner to fix the topology of braid but leave the freedom to choose the representative for the braid. In the intersection of real and p-adic worlds there is no good reason for the end points of strands in this case to be algebraic at both ends of the string world sheet. One can however start from the braid defined by the end points of string world sheets, restrict the end points to be algebraic at the end with a smaller number of algebraic points and then perform a topologically non-trivial deformation of the braid so that also the points at the other end are algebraic? Non-trivial deformations need not be possible for all possible choices of algebraic braid points at the other end of braid and different choices of the set of algebraic points would give rise to different braidings. A further constraint is that only the algebraic points at which one has assign fermion or antifermion are used so that the number of braid points is not always maximal.
3. One can also ask whether one should perform the gauge fixing for the strands of the number theoretic braid using algebraic functions making sense both in real and p-adic context. This question does not seem terribly relevant since since it is only the topology of the braid that matters.

#### 4.3.7 Connection with string model and Equivalence Principle at space-time level

Coset construction allows to generalize Equivalence Principle and understand it at quantum level. This is however not quite enough: a precise understanding of Equivalence Principle is required also at the classical level. Also the mechanism selecting via stationary phase approximation a preferred extremal of Kähler action providing a correlation between quantum numbers of the particle and geometry of the preferred extremals is still poorly understood.

#### Is stringy action principle coded by the geometry of preferred extremals?

It seems very difficult to deduce Equivalence Principle as an identity of gravitational and inertial masses identified as Noether charges associated with corresponding action principles. Since string model is an excellent theory of quantum gravitation, one can consider a less direct approach in which one tries to deduce a connection between classical TGD and string model and hope that the bridge from string model to General Relativity is easier to build. Number theoretical compactification gives good hopes that this kind of connection exists.

1. Number theoretic compactification implies that the preferred extremals of Kähler action have the property that one can assign to each point of  $M^4$  projection  $P_{M^4}(X^4(X_l^3))$  of the preferred extremal  $M^2(x)$  identified as the plane of non-physical polarizations and also as the plane in which local massless four-momentum lies.
2. If the distribution of the planes  $M^2(x)$  is integrable, one can slice  $P_{M^4}(X^4(X_l^3))$  to string world-sheets. The intersection of string world sheets with  $X^3 \subset \delta M_{\pm}^4 \times CP_2$  corresponds to a light-like curve having tangent in local tangent space  $M^2(x)$  at light-cone boundary. This is the first candidate for the definition of number theoretic braid. Second definition assumes  $M^2$  to be fixed at  $\delta CD$ : in this case the slicing is parameterized by the sphere  $S^2$  defined by the light rays of  $\delta M_{\pm}^4$ .
3. One can assign to the string world sheet -call it  $Y^2$  - the standard area action

$$S_G(Y^2) = \int_{Y^2} T \sqrt{g_2} d^2 y \ , \tag{4.3.1}$$

where  $g_2$  is either the induced metric or only its  $M^4$  part. The latter option looks more natural since  $M^4$  projection is considered.  $T$  is string tension.

4. The naivest guess would be  $T = 1/\hbar G$  apart from some numerical constant but one must be very cautious here since  $T = 1/L_p^2$  apart from a numerical constant is also a good candidate if one accepts the basic argument identifying  $G$  in terms of p-adic length  $L_p$  and Kähler action for two pieces of  $CP_2$  type vacuum extremals representing propagating graviton. The formula reads  $G = L_p^2 \exp(-2a S_K(CP_2))$ ,  $a \leq 1$  [K2, K25] . The interaction strength which would be  $L_p^2$  without the presence of  $CP_2$  type vacuum extremals is reduced by the exponential factor coming from the exponent of Kähler function of configuration space.
5. One would have string model in either  $CD \times CP_2$  or  $CD \subset M^4$  with the constraint that stringy world sheet belongs to  $X^4(X_l^3)$ . For the extremals of  $S_G(Y^2)$  gravitational four-momentum defined as Noether charge is conserved. The extremal property of string world sheet need not however be consistent with the preferred extremal property. This constraint might bring in coupling of gravitons to matter. The natural guess is that graviton corresponds to a string connecting wormhole contacts. The strings could also represent formation of gravitational bound states when they connect wormhole contacts separated by a large distance. The energy of the string is roughly  $E \sim \hbar T L$  and for  $T = 1/\hbar G$  gives  $E \sim L/G$ . Macroscopic strings are not allowed except as models of black holes. The identification  $T \sim 1/L_p^2$  gives  $E \sim \hbar L/L_p^2$ , which does not favor long strings for large values of  $\hbar$ . The identification  $G_p = L_p^2/\hbar_0$  gives  $T = 1/\hbar G_p$  and  $E \sim \hbar_0 L/L_p^2$ , which makes sense and allows strings with length not much longer than p-adic length scale. Quantization - that is the presence of configuration space degrees of freedom - would bring in massless gravitons as deformations of string whereas strings would carry the gravitational mass.
6. The exponent  $\exp(iS_G)$  can appear as a phase factor in the definition of quantum states for preferred extremals.  $S_G$  is not however enough. One can assign also to the points of number theoretic braid action describing the interaction of a point like current  $Q dx^\mu/ds$  with induced gauge potentials  $A_\mu$ . The corresponding contribution to the action is

$$S_{braid} = \int_{braid} i Tr(Q \frac{dx^\mu}{ds} A_\mu) dx \ . \tag{4.3.2}$$

In stationary phase approximation subject to the additional constraint that a preferred extremal of Kähler action is in question one obtains the desired correlation between the geometry of preferred extremal and the quantum numbers of elementary particle. This interaction term carries information only about the charges of elementary particle. It is quite possible that the interaction term is more complex: for instance, it could contain spin dependent terms (Stern-Gerlach experiment).

7. The constraint coming from preferred extremal property of Kähler action can be expressed in terms of Lagrange multipliers

$$S_c = \int_{Y^2} \lambda^k D_\alpha \left( \frac{\partial L_K}{\partial \alpha h^k} \right) \sqrt{g_2} d^2 y . \quad (4.3.3)$$

8. The action exponential reads as

$$\exp(iS_G + S_{\text{braid}} + S_c) . \quad (4.3.4)$$

The resulting field equations couple stringy  $M^4$  degrees of freedom to the second variation of Kähler action with respect to  $M^4$  coordinates and involve third derivatives of  $M^4$  coordinates at the right hand side. If the second variation of Kähler action with respect to  $M^4$  coordinates vanishes, free string results. This is trivially the case if a vacuum extremal of Kähler action is in question.

9. An interesting question is whether the preferred extremal property boils down to the condition that the second variation of Kähler action with respect to  $M^4$  coordinates or actually all coordinates vanishes so that gravitonic string is free. As a matter fact, the stronger condition is required that the Noether currents associated with the modified Dirac action are conserved. The physical interpretation would be in terms of quantum criticality which is the basic conjecture about the dynamics of quantum TGD. This is clear from the fact that in 1-D system criticality means that the potential  $V(x) = ax + bx^2 + \dots$  has  $b = 0$ . In field theory criticality corresponds to the vanishing of the term  $m^2 \phi^2/2$  so that massless situation corresponds to massless theory and criticality and long range correlations. For more than one dynamical variable there is a hierarchy of criticalities corresponding to the gradual reduction of the rank of the matrix of the matrix defined by the second derivatives of  $V(x)$  and this gives rise to a classification of criticalities. Maximum criticality would correspond to the total vanishing of this matrix. In infinite-D case this hierarchy is infinite.

### What does the equality of gravitational and inertial masses mean?

Consider next the question in what form Equivalence Principle could be realized in this framework.

1. Coset construction inspires the conjecture that gravitational and inertial four-momenta are identical. Also some milder form of it would make sense. What is clear is that the construction of preferred extremal involving the distribution of  $M^2(x)$  implies that conserved four-momentum associated with Kähler action can be expressed formally as stringy four-momentum. The integral of the conserved inertial momentum current over  $X^3$  indeed reduces to an integral over the curve defining string as one integrates over other two degrees of freedom. It would not be surprising if a stringy expression for four-momentum would result but with string tension depending on the point of string and possibly also on the component of four-momentum. If the dependence of string tension on the point of string and on the choice of the stringy world sheet is slow, the interpretation could be in terms of coupling constant evolution associated with the stringy coordinates. An alternative interpretation is that string tension corresponds to a scalar field. A quite reasonable option is that for given  $X_l^3$   $T$  defines a scalar field and that the observed  $T$  corresponds to the average value of  $T$  over deformations of  $X_l^3$ .
2. The minimum option is that Kähler mass is equal to the sum gravitational masses assignable to strings connecting points of wormhole throat or two different wormhole throats. This hypothesis makes sense even for wormhole contacts having size of order Planck length.

3. The condition that gravitational mass equals to the inertial mass (rest energy) assigned to Kähler action is the most obvious condition that one can imagine. The breaking of Poincare invariance to Lorentz invariance with respect to the tip of  $CD$  supports this form of Equivalence Principle. This would predict the value of the ratio of the parameter  $R^2T$  and p-adic length scale hypothesis would allow only discrete values for this parameter.  $p \simeq 2^k$  following from the quantization of the temporal distance  $T(n)$  between the tips of  $CD$  as  $T(n) = 2^n T_0$  would suggest string tension  $T_n = 2^n R^2$  apart from a numerical factor.  $G_p \propto 2^n R^2 / \hbar_0$  would emerge as a prediction of the theory.  $G$  can be seen either as a prediction or RG invariant input parameter fixed by quantum criticality. The arguments related to p-adic coupling constant evolution suggest  $R^2 / \hbar_0 G = 3 \times 2^{23}$  [K2, K25] .
4. The scalar field property of string tension should be consistent with the vacuum degeneracy of Kähler action. For instance, for the vacuum extremals of Kähler action stringy action is non-vanishing. The simplest possibility is that one includes the integral of the scalar  $J^{\mu\nu} J_{\mu\nu}$  over the degrees transversal to  $M^2$  to the stringy action so that string tension vanishes for vacuum extremals. This would be nothing but dimensional reduction of 4-D theory to a 2-D theory using the slicing of  $X^4(X_i^3)$  to partonic 2-surfaces and stringy word sheets. For cosmic strings Kähler action reduces to stringy action with string tension  $T \propto 1/g_K^2 R^2$  apart from a numerical constant. If one wants consistency with  $T \propto 1/L_p^2$ , one must have  $T \propto 1/g_K^2 2^n R^2$  for the cosmic strings deformed to Kähler magnetic flux tubes. This looks rather plausible if the thickness of deformed string in  $M^4$  degrees of freedom is given by p-adic length scale.

## 4.4 Does modified Dirac action define the fundamental action principle?

Although quantum criticality in principle predicts the possible values of Kähler coupling strength, one might hope that there exists even more fundamental approach involving no coupling constants and predicting even quantum criticality and realizing quantum gravitational holography. The Dirac determinant associated with the modified Dirac action is an excellent candidate in this respect.

The original working hypothesis was that Dirac determinant defines the vacuum functional of the theory having interpretation as the exponent of Kähler function of world of classical worlds (WCW) expressible and that Kähler function reduces to Kähler action for a preferred extremal of Kähler action.

### 4.4.1 What are the basic equations of quantum TGD?

A good place to start is to ask what might the basic equations of quantum TGD. There are two kinds of equations at the level of space-time surfaces.

1. Purely classical equations define the dynamics of the space-time sheets as preferred extremals of Kähler action. Preferred extremals are quantum critical in the sense that second variation vanishes for critical deformations representing zero modes. This condition guarantees that corresponding fermionic currents are conserved. There is infinite hierarchy of these currents and they define fermionic counterparts for zero modes. Space-time sheets can be also regarded as hyper-quaternionic surfaces. What these statements precisely mean has become clear only during this year. A rigorous proof for the equivalence of these two identifications is still lacking.
2. The purely quantal equations are associated with the representations of various super-conformal algebras and with the modified Dirac equation. The requirement that there are deformations of the space-time surface -actually infinite number of them- giving rise to conserved fermionic charges implies quantum criticality at the level of Kähler action in the sense of critical deformations. The precise form of the modified Dirac equation is not however completely fixed without further input. Quantal equations involve also generalized Feynman rules for  $M$ -matrix generalizing  $S$ -matrix to a "complex square root" of density matrix and defined by time-like entanglement coefficients between positive and negative energy parts of zero energy states is certainly the basic goal of quantum TGD.

3. The notion of weak electric-magnetic duality generalizing the notion of electric-magnetic duality [?] , [?] leads to a detailed understanding of how TGD reduces to almost topological quantum field theory [?] , [?] . If Kähler current defines Beltrami flow [?] it is possible to find a gauge in which Coulomb contribution to Kähler action vanishes so that it reduces to Chern-Simons term. If light-like 3-surfaces and ends of space-time surface are extremals of Chern-Simons action also effective 2-dimensionality is realized. The condition that the theory reduces to almost topological QFT and the hydrodynamical character of field equations leads to a detailed ansatz for the general solution of field equations and also for the solutions of the modified Dirac equation relying on the notion of Beltrami flow for which the flow parameter associated with the flow lines defined by a conserved current extends to a global coordinate. This makes the theory in well-defined sense completely integrable. Direct connection with massless theories emerges: every conserved Beltrami currents corresponds to a pair of scalar functions with the first one satisfying massless d'Alembert equation in the induced metric. The orthogonality of the gradients of these functions allows interpretation in terms of polarization and momentum directions. The Beltrami flow property can be also seen as one aspect of quantum criticality since the conserved currents associated with critical deformations define this kind of pairs.
  
4. The hierarchy of Planck constants provides also a fresh view to the quantum criticality. The original justification for the hierarchy of Planck constants came from the indications that Planck constant could have large values in both astrophysical systems involving dark matter and also in biology. The realization of the hierarchy in terms of the singular coverings and possibly also factor spaces of  $CD$  and  $CP_2$  emerged from consistency conditions. It however seems that TGD actually predicts this hierarchy of covering spaces. The extreme non-linearity of the field equations defined by Kähler action means that the correspondence between canonical momentum densities and time derivatives of the imbedding space coordinates is 1-to-many. This leads naturally to the introduction of the covering space of  $CD \times CP_2$ , where  $CD$  denotes causal diamond defined as intersection of future and past directed light-cones.

At the level of WCW there is the generalization of the Dirac equation which can be regarded as a purely classical Dirac equation. The modified Dirac operators associated with quarks and leptons carry fermion number but the Dirac equations are well-defined. An orthogonal basis of solutions of these Dirac operators define in zero energy ontology a basis of zero energy states. The  $M$ -matrices defining entanglement between positive and negative energy parts of the zero energy state define what can be regarded as analogs of thermal S-matrices. The  $M$ -matrices associated with the solution basis of the WCW Dirac equation define by their orthogonality unitary  $U$ -matrix between zero energy states. This matrix finds the proper interpretation in TGD inspired theory of consciousness. WCW Dirac equation as the analog of super-Virasoro conditions for the "gamma fields" of superstring models defining super counterparts of Virasoro generators was the main focus during earlier period of quantum TGD but has not received so much attention lately and will not be discussed in this chapter.

#### 4.4.2 Quantum criticality and modified Dirac action

The precise mathematical formulation of quantum criticality has remained one of the basic challenges of quantum TGD. The question leading to a considerable progress in the problem was simple: Under what conditions the modified Dirac action allows to assign conserved fermionic currents with the deformations of the space-time surface? The answer was equally simple: These currents exist only if these deformations correspond to vanishing second variations of Kähler action - which is what criticality is. The vacuum degeneracy of Kähler action strongly suggests that the number of critical deformations is always infinite and that these deformations define an infinite inclusion hierarchy of super-conformal algebras. This inclusion hierarchy would correspond to a fractal hierarchy of breakings of super-conformal symmetry generalizing the symmetry breaking hierarchies of gauge theories. These super-conformal inclusion hierarchies would realize the inclusion hierarchies for hyper-finite factors of type  $II_1$ .



### Quantum criticality and fermionic representation of conserved charges associated with second variations of Kähler action

It is rather obvious that TGD allows a huge generalizations of conformal symmetries. The development of the understanding of conservation laws has been slow. Modified Dirac action provides excellent candidates for quantum counterparts of Noether charges. Unfortunately, the isometry charges vanish for Cartan algebras. The only manner to obtain non-trivial isometry charges is to add a direct coupling to the charges in Cartan algebra as will be found later. This addition involves Chern-Simons Dirac action so that the original intuition guided by almost TQFT idea was not wrong after all.

1. *Conservation of the fermionic current requires the vanishing of the second variation of Kähler action*

1. The modified Dirac action assigns to a deformation of the space-time surface a conserved charge expressible as bilinears of fermionic oscillator operators only if the first variation of the modified Dirac action under this deformation vanishes. The vanishing of the first variation for the modified Dirac action is equivalent with the vanishing of the second variation for the Kähler action. This can be seen by the explicit calculation of the second variation of the modified Dirac action and by performing partial integration for the terms containing derivatives of  $\Psi$  and  $\bar{\Psi}$  to give a total divergence representing the difference of the charge at upper and lower boundaries of the causal diamond plus a four-dimensional integral of the divergence term defined as the integral of the quantity

$$\begin{aligned} \Delta S_D &= \bar{\Psi} \Gamma^k D_\alpha J_k^\alpha \Psi , \\ J_k^\alpha &= \frac{\partial^2 L_K}{\partial h_\alpha^k \partial h_\beta^l} \delta h_\beta^k + \frac{\partial^2 L_K}{\partial h_\alpha^k \partial h^l} \delta h^l . \end{aligned} \quad (4.4.1)$$

Here  $h_\beta^k$  denote partial derivative of the imbedding space coordinate with respect to space-time coordinates. This term must vanish:

$$D_\alpha J_k^\alpha = 0 .$$

The condition states the vanishing of the second variation of Kähler action. This can of course occur only for preferred deformations of  $X^4$ . One could consider the possibility that these deformations vanish at light-like 3-surfaces or at the boundaries of CD. Note that covariant divergence is in question so that  $J_k^\alpha$  does not define conserved classical charge in the general case.

2. It is essential that the modified Dirac equation holds true so that the modified Dirac action vanishes: this is needed to cancel the contribution to the second variation coming from the determinant of the induced metric. The condition that the modified Dirac equation is satisfied for the deformed space-time surface requires that also  $\Psi$  suffers a transformation determined by the deformation. This gives

$$\delta \Psi = -\frac{1}{D} \times \Gamma^k J_k^\alpha \Psi . \quad (4.4.2)$$

Here  $1/D$  is the inverse of the modified Dirac operator defining the counterpart of the fermionic propagator.

3. The fermionic conserved currents associated with the deformations are obtained from the standard conserved fermion current

$$J^\alpha = \bar{\Psi} \Gamma^\alpha \Psi . \quad (4.4.3)$$

Note that this current is conserved only if the space-time surface is extremal of Kähler action: this is also needed to guarantee Hermiticity and same form for the modified Dirac equation for  $\Psi$  and its conjugate as well as absence of mass term essential for super-conformal invariance [?, ?] . Note also that ordinary divergence rather only covariant divergence of the current vanishes.

The conserved currents are expressible as sums of three terms. The first term is obtained by replacing modified gamma matrices with their increments in the deformation keeping  $\Psi$  and its conjugate constant. Second term is obtained by replacing  $\Psi$  with its increment  $\delta\Psi$ . The third term is obtained by performing same operation for  $\delta\bar{\Psi}$ .

$$J^\alpha = \bar{\Psi} \Gamma^k J_k^\alpha \Psi + \bar{\Psi} \hat{\Gamma}^\alpha \delta\Psi + \delta\bar{\Psi} \hat{\Gamma}^\alpha \Psi . \quad (4.4.4)$$

These currents provide a representation for the algebra defined by the conserved charges analogous to a fermionic representation of Kac-Moody algebra [?] .

4. Also conserved super charges corresponding to super-conformal invariance are obtained. The first class of super currents are obtained by replacing  $\Psi$  or  $\bar{\Psi}$  right-handed neutrino spinor or its conjugate in the expression for the conserved fermion current and performing the above procedure giving two terms since nothing happens to the covariantly constant right handed-neutrino spinor. Second class of conserved currents is defined by the solutions of the modified Dirac equation interpreted as c-number fields replacing  $\Psi$  or  $\bar{\Psi}$  and the same procedure gives three terms appearing in the super current.
5. The existence of vanishing of second variations is analogous to criticality in systems defined by a potential function for which the rank of the matrix defined by second derivatives of the potential function vanishes at criticality. Quantum criticality becomes the prerequisite for the existence of quantum theory since fermionic anti-commutation relations in principle can be fixed from the condition that the algebra in question is equivalent with the algebra formed by the vector fields defining the deformations of the space-time surface defining second variations. Quantum criticality in this sense would also select preferred extremals of Kähler action as analogs of Bohr orbits and the the spectrum of preferred extremals would be more or less equivalent with the expected existence of infinite-dimensional symmetry algebras.

## 2. About the general structure of the algebra of conserved charges

Some general comments about the structure of the algebra of conserved charges are in order.

1. Any Cartan algebra of the isometry group  $P \times SU(3)$  (there are two types of them for  $P$  corresponding to linear and cylindrical Minkowski coordinates) defines critical deformations (one could require that the isometries respect the geometry of  $CD$ ). The corresponding charges are conserved but vanish since the corresponding conjugate coordinates are cyclic for the Kähler metric and Kähler form so that the conserved current is proportional to the gradient of a Killing vector field which is constant in these coordinates. Therefore one cannot represent isometry charges as fermionic bilinears. Four-momentum and color quantum numbers are defined for Kähler action as classical conserved quantities but this is probably not enough. This can be seen as a problem.
  - (a) Four-momentum and color Cartan algebra emerge naturally in the representations of super-conformal algebras. In the case of color algebra the charges in the complement of the Cartan algebra can be constructed in standard manner as extension of those for the Cartan algebra

using free field representation of Kac-Moody algebras. In string theories four-momentum appears linearly in bosonic Kac-Moody generators and in Sugawara construction [?] of super Virasoro generators as bilinears of bosonic Kac-Moody generators and fermionic super Kac-Moody generators [?]. Also now quantized transversal parts for  $M^4$  coordinates could define a second quantized field having interpretation as an operator acting on spinor fields of WCW. The angle coordinates conjugate to color isospin and hyper charge take the role of  $M^4$  coordinates in case of  $CP_2$ .

- (b) Somehow one should be able to feed the information about the super-conformal representation of the isometry charges to the modified Dirac action by adding to it a term coupling fermionic current to the Cartan charges in general coordinate invariant and isometry invariant manner. As will be shown later, this is possible. The interpretation is as measurement interaction guaranteeing also the stringy character of the fermionic propagators. The values of the couplings involved are fixed by the condition of quantum criticality assumed in the sense that Kähler function of WCW suffers only a  $U(1)$  gauge transformation  $K \rightarrow K + f + \bar{f}$ , where  $f$  is a holomorphic function of WCW coordinates depending also on zero modes.
  - (c) The simplest addition involves the modified gamma matrices defined by a Chern-Simon term at the light-like wormhole throats and is sum of Chern-Simons Dirac action and corresponding coupling term linear in Cartan charges assignable to the partonic 2-surfaces at the ends of the throats. Hence the modified Dirac equation in the interior of the space-time sheet is not affected and nothing changes as far as quantum criticality in interior is considered.
2. The action defined by four-volume gives a first glimpse about what one can expect. In this case modified gamma matrices reduce to the induced gamma matrices. Second variations satisfy d'Alembert type equation in the induced metric so that the analogs of massless fields are in question. Mass term is present only if some dimensions are compact. The vanishing of excitations at light-like boundaries is a natural boundary condition and might well imply that the solution spectrum could be empty. Hence it is quite possible that four-volume action leads to a trivial theory.
  3. For the vacuum extremals of Kähler action the situation is different. There exists an infinite number of second variations and the classical non-determinism suggests that deformations vanishing at the light-like boundaries exist. For the canonical imbedding of  $M^4$  the equation for second variations is trivially satisfied. If the  $CP_2$  projection of the vacuum extremal is one-dimensional, the second variation contains a non-vanishing term and an equation analogous to massless d'Alembert equation for the increments of  $CP_2$  coordinates is obtained. Also for the vacuum extremals of Kähler action with 2-D  $CP_2$  projection all terms involving induced Kähler form vanish and the field equations reduce to d'Alembert type equations for  $CP_2$  coordinates. A possible interpretation is as the classical analog of Higgs field. For the deformations of non-vacuum extremals this would suggest the presence of terms analogous to mass terms: these kind of terms indeed appear and are proportional to  $\delta s^k$ .  $M^4$  degrees of freedom decouple completely and one obtains QFT type situation.
  4. The physical expectation is that at least for the vacuum extremals the critical manifold is infinite-dimensional. The notion of finite measurement resolution suggests infinite hierarchies of inclusions of hyper-finite factors of type  $II_1$  possibly having interpretation in terms of inclusions of the super conformal algebras defined by the critical deformations.
  5. The properties of Kähler action give support for this expectation. The critical manifold is infinite-dimensional in the case of vacuum extremals. Canonical imbedding of  $M^4$  would correspond to maximal criticality analogous to that encountered at the tip of the cusp catastrophe. The natural guess would be that as one deforms the vacuum extremal the previously critical degrees of freedom are transformed to non-critical ones. The dimension of the critical manifold could remain infinite for all preferred extremals of the Kähler action. For instance, for cosmic string like objects any complex manifold of  $CP_2$  defines cosmic string like objects so that there is a huge degeneracy is expected also now. For  $CP_2$  type vacuum extremals  $M^4$  projection is arbitrary light-like curve so that also now infinite degeneracy is expected for the deformations.

### 3. Critical super algebra and zero modes

The relationship of the critical super-algebra to configuration space geometry is interesting.

1. The vanishing of the second variation plus the identification of Kähler function as a Kähler action for preferred extremals means that the critical variations are orthogonal to all deformations of the space-time surface with respect to the configuration space metric and thus correspond to zero modes. This conforms with the fact that configuration space metric vanishes identically for canonically imbedded  $M^4$ . Zero modes do not seem to correspond to gauge degrees of freedom so that the super-conformal algebra associated with the zero modes has genuine physical content.
2. Since the action of  $X^4$  local Hamiltonians of  $\delta M^4_{\times} CP_2$  corresponds to the action in quantum fluctuating degrees of freedom, critical deformations cannot correspond to this kind of Hamiltonians.
3. The notion of finite measurement resolution suggests that the degrees of freedom which are below measurement resolution correspond to vanishing gauge charges. The sub-algebras of critical super-conformal algebra for which charges annihilate physical states could correspond to this kind of gauge algebras.
4. The conserved super charges associated with the vanishing second variations cannot give configuration space metric as their anti-commutator. This would also lead to a conflict with the effective 2-dimensionality stating that the configuration space line-element is expressible as sum of contribution coming from partonic 2-surfaces as also with fermionic anti-commutation relations.

### 4. Connection with quantum criticality

The vanishing of the second variation for some deformations means that the system is critical, in the recent case quantum critical. Basic example of criticality is bifurcation diagram for cusp catastrophe. For some mysterious reason I failed to realize that quantum criticality realized as the vanishing of the second variation makes possible a more or less unique identification of preferred extremals and considered alternative identifications such as absolute minimization of Kähler action which is just the opposite of criticality. Both the super-symmetry of  $D_K$  and conservation Dirac Noether currents for modified Dirac action have thus a connection with quantum criticality.

1. Finite-dimensional critical systems defined by a potential function  $V(x^1, x^2, \dots)$  are characterized by the matrix defined by the second derivatives of the potential function and the rank of system classifies the levels in the hierarchy of criticalities. Maximal criticality corresponds to the complete vanishing of this matrix. Thom's catastrophe theory classifies these hierarchies, when the numbers of behavior and control variables are small (smaller than 5). In the recent case the situation is infinite-dimensional and the criticality conditions give additional field equations as existence of vanishing second variations of Kähler action.
2. The vacuum degeneracy of Kähler action allows to expect that this kind infinite hierarchy of criticalities is realized. For a general vacuum extremal with at most 2-D  $CP_2$  projection the matrix defined by the second variation vanishes because  $J_{\alpha\beta} = 0$  vanishes and also the matrix  $(J_k^\alpha + J_k^\alpha)(J_l^\beta + J_l^\beta)$  vanishes by the antisymmetry  $J_k^\alpha = -J_k^\alpha$ . Recall that the formulation of Equivalence Principle in string picture demonstrated that the reduction of stringy dynamics to that for free strings requires that second variation with respect to  $M^4$  coordinates vanish. This condition would guarantee the conservation of fermionic Noether currents defining gravitational four-momentum and other Poincare quantum numbers but not those for gravitational color quantum numbers. Encouragingly, the action of  $CP_2$  type vacuum extremals having random light-like curve as  $M^4$  projection have vanishing second variation with respect to  $M^4$  coordinates (this follows from the vanishing of Kähler energy momentum tensor, second fundamental form, and Kähler gauge current). In this case however the momentum is vanishing.
3. Conserved bosonic and fermionic Noether charges would characterize quantum criticality. In particular, the isometries of the imbedding space define conserved currents represented in terms of the fermionic oscillator operators if the second variations defined by the infinitesimal isometries

vanish for the modified Dirac action. For vacuum extremals the dimension of the critical manifold is infinite: maybe there is hierarchy of quantum criticalities for which this dimension decreases step by step but remains always infinite. This hierarchy could closely relate to the hierarchy of inclusions of hyper-finite factors of type  $II_1$ . Also the conserved charges associated with Super-symplectic and Super Kac-Moody algebras would require infinite-dimensional critical manifold defined by the spectrum of second variations.

4. Phase transitions are characterized by the symmetries of the phases involved with the transitions, and it is natural to expect that dynamical symmetries characterize the hierarchy of quantum criticalities. The notion of finite quantum measurement resolution based on the hierarchy of Jones inclusions indeed suggests the existence of a hierarchy of dynamical gauge symmetries characterized by gauge groups in ADE hierarchy [K25] with degrees of freedom below the measurement resolution identified as gauge degrees of freedom.
5. A breakthrough in understanding of the criticality was the discovery that the realization that the hierarchy of singular coverings of  $CD \times CP_2$  needed to realize the hierarchy of Planck constants could correspond directly to a similar hierarchy of coverings forced by the factor that classical canonical momentum densities correspond to several values of the time derivatives of the imbedding space coordinates led to a considerable progress if the understanding of the relationship between criticality and hierarchy of Planck constants [?] , [?] . Therefore the problem which led to the geometrization program of quantum TGD, also allowed to reduce the hierarchy of Planck constants introduced on basis of experimental evidence to the basic quantum TGD. One can say that the 3-surfaces at the ends of  $CD$  resp. wormhole throats are critical in the sense that they are unstable against splitting to  $n_b$  resp.  $n_a$  surfaces so that one obtains space-time surfaces which can be regarded as surfaces in  $n_a \times n_b$  fold covering of  $CD \times CP_2$ . This allows to understand why Planck constant is effectively replaced with  $n_a n_b \hbar_0$  and explains charge fractionization.

#### Preferred extremal property as classical correlate for quantum criticality, holography, and quantum classical correspondence

The Noether currents assignable to the modified Dirac equation are conserved only if the first variation of the modified Dirac operator  $D_K$  defined by Kähler action vanishes. This is equivalent with the vanishing of the second variation of Kähler action -at least for the variations corresponding to dynamical symmetries having interpretation as dynamical degrees of freedom which are below measurement resolution and therefore effectively gauge symmetries.

The vanishing of the second variation in interior of  $X^4(X_l^3)$  is what corresponds exactly to quantum criticality so that the basic vision about quantum dynamics of quantum TGD would lead directly to a precise identification of the preferred extremals. Something which I should have noticed for more than decade ago! The question whether these extremals correspond to absolute minima remains however open.

The vanishing of second variations of preferred extremals -at least for deformations representing dynamical symmetries, suggests a generalization of catastrophe theory of Thom, where the rank of the matrix defined by the second derivatives of potential function defines a hierarchy of criticalities with the tip of bifurcation set of the catastrophe representing the complete vanishing of this matrix. In the recent case this theory would be generalized to infinite-dimensional context. There are three kind of variables now but quantum classical correspondence (holography) allows to reduce the types of variables to two.

1. The variations of  $X^4(X_l^3)$  vanishing at the intersections of  $X^4(X_l^3)$  with the light-like boundaries of causal diamonds  $CD$  would represent behavior variables. At least the vacuum extremals of Kähler action would represent extremals for which the second variation vanishes identically (the "tip" of the multi-furcation set).
2. The zero modes of Kähler function would define the control variables interpreted as classical degrees of freedom necessary in quantum measurement theory. By effective 2-dimensionality (or holography or quantum classical correspondence) meaning that the configuration space metric is determined by the data coming from partonic 2-surfaces  $X^2$  at intersections of  $X_l^3$  with

boundaries of  $CD$ , the interiors of 3-surfaces  $X^3$  at the boundaries of  $CD$ s in rough sense correspond to zero modes so that there is indeed huge number of them. Also the variables characterizing 2-surface, which cannot be complexified and thus cannot contribute to the Kähler metric of configuration space represent zero modes. Fixing the interior of the 3-surface would mean fixing of control variables. Extremum property would fix the 4-surface and behavior variables if boundary conditions are fixed to sufficient degree.

3. The complex variables characterizing  $X^2$  would represent third kind of variables identified as quantum fluctuating degrees of freedom contributing to the configuration space metric. Quantum classical correspondence requires 1-1 correspondence between zero modes and these variables. This would be essentially holography stating that the 2-D "causal boundary"  $X^2$  of  $X^3(X^2)$  codes for the interior. Preferred extremal property identified as criticality condition would realize the holography by fixing the values of zero modes once  $X^2$  is known and give rise to the holographic correspondence  $X^2 \rightarrow X^3(X^2)$ . The values of behavior variables determined by extremization would fix then the space-time surface  $X^4(X^3)$  as a preferred extremal.
4. Clearly, the presence of zero modes would be absolutely essential element of the picture. Quantum criticality, quantum classical correspondence, holography, and preferred extremal property would all represent more or less the same thing. One must of course be very cautious since the boundary conditions at  $X^3$  involve normal derivative and might bring in delicacies forcing to modify the simplest heuristic picture.
5. There is a possible connection with the notion of self-organized criticality [?] introduced to explain the behavior of systems like sand piles. Self-organization in these systems tends to lead "to the edge". The challenge is to understand how system ends up to a critical state, which by definition is unstable. Mechanisms for this have been discovered and based on phase transitions occurring in a wide range of parameters so that critical point extends to a critical manifold. In TGD Universe quantum criticality suggests a universal mechanism of this kind. The criticality for the preferred extremals of Kähler action would mean that classically all systems are critical in well-defined sense and the question is only about the degree of criticality. Evolution could be seen as a process leading gradually to increasingly critical systems. One must however distinguish between the criticality associated with the preferred extremals of Kähler action and the criticality caused by the spin glass like energy landscape like structure for the space of the maxima of Kähler function.

#### 4.4.3 Handful of problems with a common resolution

Theory building could be compared to pattern recognition or to a solving a crossword puzzle. It is essential to make trials, even if one is aware that they are probably wrong. When stares long enough to the letters which do not quite fit, one suddenly realizes what one particular crossword must actually be and it is soon clear what those other crosswords are. In the following I describe an example in which this analogy is rather concrete. Let us begin by listing the problems.

1. The condition that modified Dirac action allows conserved charges leads to the condition that the symmetries in question give rise to vanishing second variations of Kähler action. The interpretation is as quantum criticality and there are good arguments suggesting that the critical symmetries define an infinite-dimensional super-conformal algebra forming an inclusion hierarchy related to a sequence of symmetry breakings closely related to a hierarchy of inclusions of hyper-finite factors of types  $II_1$  and  $III_1$ . This means an enormous generalization of the symmetry breaking patterns of gauge theories.

There is however a problem. For the translations of  $M^4$  and color hyper charge and isospin (more generally, any Cartan algebra of  $P \times SU(3)$ ) the resulting fermionic charges vanish. The trial for the crossword in absence of nothing better would be the following argument. By the abelianity of these charges the vanishing of quantal representation of four-momentum and color Cartan charges is not a problem and that classical representation of these charges or their super-conformal representation is enough.

2. Modified Dirac equation is satisfied in the interior of space-time surface always. This means that one does not obtain off-mass shell propagation at all in 4-D sense. Effective 2-dimensionality

suggests that off mass shell propagation takes place along wormhole throats. The reduction to almost topological QFT with Kähler function reducing to Chern-Simons type action implied by the weak form of electric-magnetic duality and a proper gauge choice for the induced Kähler gauge potential implies effective 3-dimensionality at classical level. This inspires the question whether Chern-Simons type action resulting from an instanton term could define the modified gamma matrices appearing in the 3-D modified Dirac action associated with wormhole throats and the ends of the space-time sheet at the boundaries of  $CD$ .

The assumption that modified Dirac equation is satisfied also at the ends and wormhole throats would realize effective 2-dimensionality as conditions on the boundary values of the 4-D Dirac equation but would not allow off mass shell propagation. Therefore one could argue that effective 2-dimensionality in this sense holds true only for incoming and outgoing particles.

The reduction of Kähler action to Chern-Simons term together with effective 2-dimensionality suggests that Kähler function corresponds to an extremum of this action with a constraint term due to the weak form of electric-magnetic duality. Without this term the extrema of Chern-Simons action have 2-D  $CP_2$  projection not consistent with the weak form of electric-magnetic duality. The extrema are not maxima of Kähler function: they are obtained by varying with respect to tangent space data of the partonic 2-surfaces. Lagrange multiplier term induces also to the modified gamma matrices a contribution which is of the same general form as for any general coordinate invariant action.

3. Quantum classical correspondence requires that the geometry of the space-time sheet should correlate with the quantum numbers characterizing positive (negative) energy part of the quantum state. One could argue that by multiplying WCW spinor field by a suitable phase factor depending on the charges of the state, the correspondence follows from stationary phase approximation. This crossword looks unconvincing. A more precise connection between quantum and classical is required.
4. In quantum measurement theory classical macroscopic variables identified as degrees of freedom assignable to the interior of the space-time sheet correlate with quantum numbers. Stern Gerlach experiment is an excellent example of the situation. The generalization of the imbedding space concept by replacing it with a book like structure implies that imbedding space geometry at given page and for given causal diamond ( $CD$ ) carries information about the choice of the quantization axes (preferred plane  $M^2$  of  $M^4$  resp. geodesic sphere of  $CP_2$  associated with singular covering/factor space of  $CD$  resp.  $CP_2$ ). This is a big step but not enough. Modified Dirac action as such does not seem to provide any hint about how to achieve this correspondence. One could even wonder whether dissipative processes or at least the breaking of  $T$  and  $CP$  characterizing the outcome of quantum jump sequence should have space-time correlate. How to achieve this?

Each of these problems makes one suspect that something is lacking from the modified Dirac action: there should exist an elegant manner to feed information about quantum numbers of the state to the modified Dirac action in turn determining vacuum functional as an exponent Kähler function identified as Kähler action for the preferred extremal assumed to be dictated by quantum criticality and equivalently by hyper-quaternionicity.

This observation leads to what might be the correct question. Could a general coordinate invariant and Poincare invariant modification of the modified Dirac action consistent with the vacuum degeneracy of Kähler action allow to achieve this information flow somehow? In the following one manner to achieve this modification is discussed. It must be however emphasized that I have considered many alternatives and the one discussed below finds its justification only from the fact that it is the simplest one found hitherto.

#### The identification of the measurement interaction term

The idea is simple: add to the modified Dirac action a term which is analogous to the Dirac action in  $M^4 \times CP_2$ . One can consider two options according to whether the term is assigned with interior or with a 3-D light-like 3-surface and last years have been continual argumentation about which option is the correct one.

1. The additional term would be essentially the analog of the ordinary Dirac action at the imbedding space level.

$$\begin{aligned}
S_{int} &= \sum_A Q_A \int \bar{\Psi} g^{AB} j_{B\alpha} \hat{\Gamma}^\alpha \Psi \sqrt{g} d^4x , \\
g_{AB} &= j_A^k h_{kl} j_B^l , \quad g^{AB} g_{BC} = \delta_C^A , \\
j_{B\alpha} &= j_B^k h_{kl} \partial_\alpha h^l .
\end{aligned} \tag{4.4.5}$$

The sum is over isometry charges  $Q_A$  interpreted as quantal charges and  $j^{Ak}$  denotes the Killing vector field of the isometry.  $g^{AB}$  is the inverse of the tensor  $g_{AB}$  defined by the local inner products of Killing vectors fields in  $M^4$  and  $CP_2$ . The space-time projections of the Killing vector fields  $j_{B\alpha}$  have interpretation as classical color gauge potentials in the case of  $SU(3)$ . In  $M^4$  degrees of freedom and for Cartan algebra of  $SU(3)$   $j_{B\alpha}$  reduce to the gradients of linear  $M^4$  coordinates in case of translations. Modified gamma matrices could be assigned to Kähler action or its instanton term or with Chern-Simons action.

2. The added term containing quantal charges must make sense in the modified Dirac equation. This requires that the physical state is an eigenstate of momentum and color charges. This allows only color hyper-charge and color isospin so that there is no hope of obtaining exactly the stringy formula for the propagator. The modified Dirac operator is given by

$$\begin{aligned}
D &= D + D_{int} = \hat{\Gamma}^\alpha D_\alpha + \hat{\Gamma}^\alpha \sum_A Q_A g^{AB} j_{B\alpha} \\
&= \hat{\Gamma}^\alpha (D_\alpha + \partial_\alpha \phi) , \quad \partial_\alpha \phi = \sum_A Q_A g^{AB} j_{B\alpha} .
\end{aligned} \tag{4.4.6}$$

The conserved fermionic isometry currents are

$$J^{A\alpha} = \sum_B Q_B \bar{\Psi} g^{BC} j_C^k h_{kl} j_A^l \hat{\Gamma}^\alpha \Psi = Q_A \bar{\Psi} \hat{\Gamma}^\alpha \Psi . \tag{4.4.7}$$

Here the sum is restricted to a Cartan sub-algebra of Poincare group and color group.

3. An important restriction is that by four-dimensionality of  $M^4$  and  $CP_2$  the rank of  $g_{AB}$  is 4 so that  $g^{AB}$  exists only when one considers only four conserved charges. In the case of  $M^4$  this is achieved by a restriction to translation generators  $Q_A = p_A$ .  $g_{AB}$  reduces to Minkowski metric and Killing vector fields are constants. The Cartan sub-algebra could be however replaced by any four commuting charges in the case of Poincare algebra (second one corresponds to time translation plus translation, boost and rotation in given direction). In the case of  $SU(3)$  one must restrict the consideration either to  $U(2)$  sub-algebra or its complement.  $CP_2 = SU(3)/SU(2)$  decomposition would suggest the complement as the correct choice. One can indeed build the generators of  $U(2)$  as commutators of the charges in the complement. On the other hand, Cartan algebra is enough in free field construction of Kac-Moody algebras.
4. What is remarkable that for the Cartan algebra of  $M^4 \times SU(3)$  the measurement interaction term is equivalent with the addition of gauge part  $\partial_\alpha \phi$  of the induced Kähler gauge potential  $A_\alpha$ . This property might hold true for any measurement interaction term. This also suggests that the change in Kähler function is only the transformation  $A_\alpha \rightarrow A_\alpha + \partial_\alpha \phi$ ,  $\partial_\alpha \phi = \sum_A Q_A g^{AB} j_{B\alpha}$ .
5. Recall that the  $\phi$  for  $U(1)$  gauge transformations respecting the vanishing of the Coulomb interaction term of Kähler action [?], [?] the current  $j_K^\alpha \phi$  is conserved, which implies that the change of the Kähler action is trivial. These properties characterize the gauge transformations



respecting the gauge in which Coulombic interaction term of the Kähler action vanishes so that Kähler action reduces to 3-dimensional generalized Chern-Simons term if the weak form of electric-magnetic duality holds true guaranteeing among other things that the induced Kähler field is not too singular at the wormhole throats [?] , [?] . The scalar function assignable to the measurement interaction terms does not have this property and this is what is expected since it must change the value of the Kähler function and therefore affect the preferred extremal.

Concerning the precise form of the modified Dirac action the basic clue comes from the observation that the measurement interaction term corresponds to the addition of a gauge part to the induced  $CP_2$  Kähler gauge potential  $A_\alpha$ . The basic question is what part of the action one assigns the measurement interaction term.

1. One could define the measurement interaction term using either the four-dimensional instanton term or its reduction to Chern-Simons terms. The part of Dirac action defined by the instanton term in the interior does not reduce to a 3-D form unless the Dirac equation defined by the instanton term is satisfied : this cannot be true. Hence Chern-Simons term is the only possibility. The classical field equations associated with the Chern-Simons term cannot be assumed since they would imply that the  $CP_2$  projection of the wormhole throat and space-like 3-surface are 2-dimensional. This might hold true for space-like 3-surfaces at the ends of  $CD$  and incoming and outgoing particles but not for off mass shell particles. This is however not a problem since  $D_\alpha \hat{\Gamma}_{C-S}^\alpha$  for the modified gamma matrices for Chern-Simons action does not contain second derivatives. This is due to the topological character of this term. For Kähler action second derivatives are present and this forces extremal property of Kähler action in the modified Dirac Kähler action so that classical physics results as a consistency condition.
2. If one assigns measurement interaction term to both  $D_K$  and  $D_{C-S}$  the measurement interaction corresponds to a mere gauge transformation for  $AS_\alpha$  and is trivial. Therefore it seems that one must choose between  $D_K$  or  $D_{C-S}$ . At least formally the measurement interaction term associated with  $D_K$  is gauge equivalent with its negative  $D_{C-S}$ . The addition of the measurement interaction to  $D_K$  changes the basis for the 4-D induced spinors by the phase  $exp(-iQK\phi)$  and therefore also the basis for the generalized eigenstates of  $D_{C-S}$  and this brings in effectively the measurement interaction term affecting the Dirac determinant.
3. The definition of Dirac determinant should be in terms of Chern-Simons action induced by the instanton term and identified as a product of the generalized eigenvalues of this operator. The modified Dirac equation for  $\Psi$  is consistent with that for its conjugate if the coefficient of the instanton term is real and one uses the Dirac action  $\bar{\Psi}(D^\rightarrow - D^\leftarrow)\Psi$  giving modified Dirac equation as

$$D_{C-S}\Psi + \frac{1}{2}(D_\alpha \hat{\Gamma}_{C-S}^\alpha)\Psi = 0 . \quad (4.4.8)$$

As noticed, the divergence of gamma matrices does not contain second derivatives in the case of Chern-Simons action. In the case of Kähler action they occur unless field equations equivalent with the vanishing of the divergence term are satisfied.

Also the fermionic current is conserved in this case, which conforms with the idea that fermions flow along the light-like 3-surfaces. If one uses the action  $\bar{\Psi}D^\rightarrow\Psi$ ,  $\bar{\Psi}$  does not satisfy the Dirac equation following from the variational principle and fermion current is not conserved. Also if the Chern-Simons term is imaginary - as a naive idea about dissipation would suggest- the Dirac equation fails to be consistent with the conjugation.

4. Off mass shell states appear in the lines of the generalized Feynman diagrams and for these  $D_{C-S}$  cannot annihilate the spinor field. The generalized eigen modes of  $D_{C-S}$  should be such that one obtains the counterpart of Dirac propagator which is purely algebraic and does not therefore depend on the coordinates of the throat. This is satisfied if the generalized eigenvalues are expressible in terms of covariantly constant combinations of gamma matrices and here only  $M^4$  gamma matrices are possible. Therefore the eigenvalue equation regards as

$$D\Psi = \lambda^k \gamma_k \Psi, \quad D = D_{C-S} + D_\alpha \hat{\Gamma}_{C-S}^\alpha, \quad D_{C-S} = \hat{\Gamma}_{C-S}^\alpha D_\alpha. \quad (4.4.9)$$

Here the covariant derivatives  $D_\alpha$  contain the measurement interaction term as an apparent gauge term. Covariant constancy allows to take the square of this equation and one has

$$(D^2 + [D, \lambda^k \gamma_k])\Psi = \lambda^k \lambda_k \Psi. \quad (4.4.10)$$

The commutator term is analogous to magnetic moment interaction. The generalized eigenvalues correspond to  $\lambda = \sqrt{\lambda^k \lambda_k}$  and Dirac determinant is defined as a product of the eigenvalues.  $\lambda$  is completely analogous to mass. For incoming lines this mass would vanish so that all incoming particles irrespective their actual quantum numbers would be massless in this sense and the propagator is indeed that for a massless particle. Note that the eigen modes define the boundary values for the solutions of  $D_K \Psi = 0$  so that the values of  $\lambda$  indeed define the counterpart of the momentum space.

This transmutation of massive particles to effectively massless ones might make possible the application of the twistor formalism as such in TGD framework [?].  $N = 4$  SUSY is one of the very few gauge theory which might be UV finite but it is definitely unphysical due to the masslessness of the basic quanta. Could the resolution of the interpretational problems be that the four-momenta appearing in this theory do not directly correspond to the observed four-momenta?

## Objections

The alert reader has probably raised several critical questions. Doesn't the need to solve  $\lambda_k$  as functions of incoming quantum numbers plus the need to construct the measurement interactions makes the practical application of the theory hopelessly difficult? Could the resulting pseudo-momentum  $\lambda_k$  correspond to the actual four-momentum? Could one drop the measurement interaction term altogether and assume that the quantum classical correspondence is through the identification of the eigenvalues as the four-momenta of the on mass shell particles propagating at the wormhole throats? Could one indeed assume that the momenta have a continuous spectrum and thus do not depend on the boundary conditions at all? Usually the thinking is just the opposite and in the general case would lead to singular eigen modes.

1. Only the information about four-momentum would be fed into the space-time geometry. TGD however allows much more general measurement interaction terms and it would be very strange if the space-time geometry would not correlate also with the other quantum numbers. Mass formulas would of course contain information also about other quantum numbers so that this claim is not quite justified.
2. Number theoretic considerations and also the construction of octonionic variant of Dirac equation [?], [?] force the conclusion that the spectrum of pseudo four-momentum is restricted to a preferred plane  $M^2$  of  $M^4$  and this excludes the interpretation of  $\lambda^k$  as a genuine four-momentum. It also improves the hopes that the sum over pseudo-momenta does not imply divergences.
3. Dirac determinant would depend on the mass spectrum only and could not be identified as exponent of Kähler function. Note that the original guideline was the dream about stringy propagators. This is achieved for  $\lambda_A \lambda^A = n$  in suitable units. This spectrum would of course also imply that Dirac determinant defined in terms of  $\zeta$  function regularization is independent of the space-time surface and could not be identified with the exponent of Kähler function. One must of course take the identification of exponent of Kähler function as Dirac determinant as an additional conjecture which is not necessary for the calculation of Kähler function if the weak form of electric-magnetic duality is accepted.

4. All particles would behave as massless particles and this would not be consistent with the proposed Feynman diagrammatics inspired by zero energy ontology. Since wormhole throats carry on mass shell particles with positive or negative energy so that the net momentum can be also space-like propagators diverge for massless particles. One might overcome this problem by assuming small thermal mass (from p-adic thermodynamics [K45] ) and this is indeed assumed to reduce the number of generalized Feynman diagrams contributing to a given reaction to finite number.

Second objection of the skeptic reader relates to the delicacies of  $U(1)$  gauge invariance. The modified Dirac action seems to break gauge symmetries and this breaking of gauge symmetry is absolutely essential for the dependence of the Dirac determinant on the quantum numbers. It however seems that this breaking of gauge invariance is only apparent.

1. One must distinguish between genuine  $U(1)$  gauge transformations carried out for the induced Kähler gauge potential  $A_\alpha$  and apparent gauge transformations of the Kähler gauge potential  $A_k$  of  $S^2 \times CP_2$  induced by symplectic transformations deforming the space-time surface and affect also induced metric. This delicacy of  $U(1)$  gauge symmetry explains also the apparent breaking of  $U(1)$  gauge symmetry of Chern-Simons Dirac action due to the presence of explicit terms  $A_k$  and  $A_\alpha$ .
2.  $CP_2$  Kähler gauge potential is obtained in complex coordinates from Kähler function as  $(K_{\xi^i}, K_{\bar{\xi}^i}) = (\partial_{\xi^i} K, -\partial_{\bar{\xi}^i} K)$ . Gauge transformations correspond to the additions  $K \rightarrow K + f + \bar{f}$ , where  $f$  is a holomorphic function. Kähler gauge potential has a unique gauge in which the Kähler function of  $CP_2$  is  $U(2)$  invariant and contains no holomorphic part. Hence  $A_k$  is defined in a preferred gauge and is a gauge invariant quantity in this sense. Same applies to  $S^2$  part of the Kähler potential if present.
3.  $A_\alpha$  should be also gauge invariant under gauge transformation respecting the vanishing of Coulombic interaction energy. The allowed gauge transformations  $A_\alpha \rightarrow A_\alpha + \partial_\alpha \phi$  must satisfy  $D_\alpha(j_K^\alpha \phi) = 0$ . If the scalar function  $\phi$  reduces to constant at the wormhole throats and at the ends of the space-time surface  $D_{C-S}$  is gauge invariant. The gauge transformations for which  $\phi$  does not satisfy this condition are identified as representations of critical deformations of space-time surface so that the change of  $A_\alpha$  would code for this kind of deformation and indeed affect the modified Dirac operator and Kähler function (the change would be due to the change of zero modes).

### Some details about the modified Dirac equation defined by Chern-Simons action

First some general comments about  $D_{C-S}$  are in order.

1. Quite generally, there is vacuum avoidance in the sense that  $\Psi$  must vanish in the regions where the modified gamma matrices vanish. A physical analogy for the system consider is a charged particle in an external magnetic field. The effective metric defined by the anti-commutators of the modified gamma matrices so that standard intuitions might not help much. What one would naively expect would be analogs of bound states in magnetic field localized into regions inside which the magnetic field is non-vanishing.
2. If only  $CP_2$  Kähler form appears in the Kähler action, the modified Dirac action defined by the Chern-Simons term is non-vanishing only when the dimension of the  $CP_2$  projection of the 3-surface is  $D(CP_2) \geq 2$  and the induced Kähler field is non-vanishing. This conforms with the properties of Kähler action. The solutions of the modified Dirac equation with a vanishing eigenvalue  $\lambda$  would naturally correspond to incoming and outgoing particles.
3.  $D(CP_2) \leq 2$  is apparently inconsistent with the weak form of electric-magnetic duality requiring  $D(CP_2) = 3$ . The conclusion is wrong: the variations of Chern-Simons action are subject to the constraint that electric-magnetic duality holds true expressible in terms of Lagrange multiplier term

$$\int \Lambda_\alpha (J^{n\alpha} - K \epsilon^{n\alpha\beta\gamma} J_{\beta\gamma}) \sqrt{g_4} d^3x . \quad (4.4.11)$$

This gives a constraint force to the field equations and also a dependence on the induced 4-metric so that one has only almost topological QFT. This term also guarantees the  $M^4$  part of WCW Kähler metric is non-trivial. The condition that the ends of space-time sheet and wormhole throats are extrema of Chern-Simons action subject to the electric-magnetic duality constraint is strongly suggested by the effective 2-dimensionality.

4. Electric-magnetic duality constraint gives an additional term to the Dirac action determined by the Lagrange multiplier term. This term gives an additional contribution to the modified gamma matrices having the same general form as coming from Kähler action and Chern-Simons action. In the following this term will not be considered. For the extremals it only affects the modified gamma matrices and leaves the general form of solutions unchanged.

In absence of the constraint from the weak form of electric-magnetic duality the explicit expression of  $D_{C-S}$  is given by

$$\begin{aligned} D &= \hat{\Gamma}^\mu D_\mu + \frac{1}{2} D_\mu \hat{\Gamma}^\mu , \\ \hat{\Gamma}^\mu &= \frac{\partial L_{C-S}}{\partial_\mu h^k} \Gamma_k = \epsilon^{\mu\alpha\beta} [2J_{kl} \partial_\alpha h^l A_\beta + J_{\alpha\beta} A_k] \Gamma^k D_\mu , \\ D_\mu \hat{\Gamma}^\mu &= B_K^\alpha (J_{k\alpha} + \partial_\alpha A_k) , \\ B_K^\alpha &= \epsilon^{\alpha\beta\gamma} J_{\beta\gamma} , \quad J_{k\alpha} = J_{kl} \partial_\alpha h^l , \quad \hat{\epsilon}^{\alpha\beta\gamma} = \epsilon^{\alpha\beta\gamma} \sqrt{g_3} . \end{aligned} \quad (4.4.12)$$

Note  $\hat{\epsilon}^{\alpha\beta\gamma}$  = does not depend on the induced metric.

The extremals of Chern-Simons action without constraint term satisfy

$$B_K^\alpha (J_{kl} + \partial_l A_k) \partial_\alpha h^l = 0 , \quad B_K^\alpha = \epsilon^{\alpha\beta\gamma} J_{\beta\gamma} . \quad (4.4.13)$$

For a non-vanishing Kähler magnetic field  $B^\alpha$  these equations hold true when  $CP_2$  projection is 2-dimensional. This implies a vanishing of Chern-Simons action in absence of the constraint term realizing electric-magnetic duality, which is therefore absolutely essential in order for having a non-vanishing WCW metric.

Consider now the situation in more detail.

1. Suppose that one can assign a global coordinate to the flow lines of the Kähler magnetic field. In this case one might hope that ordinary intuitions about motion in constant magnetic field might be helpful. The repetition of the discussion of [?], [?] leads to the condition  $B \wedge dB = 0$  implying that a Beltrami flow for which current flows along the field lines and Lorentz forces vanishes is in question. This need not be the generic case.
2. With this assumption the modified Dirac operator reduces to a one-dimensional Dirac operator

$$D = \hat{\epsilon}^{r\alpha\beta} [2J_{kl} \partial_\alpha h^l A_\beta + J_{\alpha\beta} A_k] \Gamma^k D_r . \quad (4.4.14)$$

3. The general solutions of the modified Dirac equation is covariantly constant with respect to the coordinate  $r$ :

$$D_r \Psi = 0 . \quad (4.4.15)$$

The solution to this condition can be written immediately in terms of a non-integrable phase factor  $P \exp(i \int A_r dr)$ , where integration is along curve with constant transversal coordinates. If  $\Gamma^v$  is light-like vector field also  $\Gamma^v \Psi_0$  defines a solution of  $D_{C-S}$ . This solution corresponds to a zero mode for  $D_{C-S}$  and does not contribute to the Dirac determinant. Note that the dependence of these solutions on transversal coordinates of  $X_i^3$  is arbitrary.

4. The formal solution associated with a general eigenvalue can be constructed by integrating the eigenvalue equation separately along all coordinate curves. This makes sense if  $r$  indeed assigned to light-like curves indeed defines a global coordinate. What is strange that there is no correlation between the behaviors with respect longitudinal coordinate and transversal coordinates. System would be like a collection of totally uncorrelated point like particles reflecting the flow of the current along flux lines. It is difficult to say anything about the spectrum of the generalized eigenvalues in this case: it might be that the boundary conditions at the ends of the flow lines fix the allowed values of  $\lambda$ . Clearly, the Beltrami flow property is what makes this case very special.

### A connection with quantum measurement theory

It is encouraging that isometry charges and also other charges could make themselves visible in the geometry of space-time surface as they should by quantum classical correspondence. This suggests an interpretation in terms of quantum measurement theory.

1. The interpretation resolves the problem caused by the fact that the choice of the commuting isometry charges is not unique. Cartan algebra corresponds naturally to the measured observables. For instance, one could choose the Cartan algebra of Poincare group to consist of energy and momentum, angular momentum and boost (velocity) in particular direction as generators of the Cartan algebra of Poincare group. In fact, the choices of a preferred plane  $M^2 \subset M^4$  and geodesic sphere  $S^2 \subset CP_2$  allowing to fix the measurement sub-algebra to a high degree are implied by the replacement of the imbedding space with a book like structure forced by the hierarchy of Planck constants. Therefore the hierarchy of Planck constants seems to be required by quantum measurement theory. One cannot overemphasize the importance of this connection.
2. One can add similar couplings of the net values of the measured observables to the currents whose existence and conservation is guaranteed by quantum criticality. It is essential that one maps the observables to Cartan algebra coupled to critical current characterizing the observable in question. The coupling should have interpretation as a replacement of the induced Kähler gauge potential with its gauge transform. Quantum classical correspondence encourages the identification of the classical charges associated with Kähler action with quantal Cartan charges. This would support the interpretation in terms of a measurement interaction feeding information to classical space-time physics about the eigenvalues of the observables of the measured system. The resulting field equations remain second order partial differential equations since the second order partial derivatives appear only linearly in the added terms.
3. What about the space-time correlates of electro-weak charges? The earlier proposal explains this correlation in terms of the properties of quantum states: the coupling of electro-weak charges to Chern-Simons term could give the correlation in stationary phase approximation. It would be however very strange if the coupling of electro-weak charges with the geometry of the space-time sheet would not have the same universal description based on quantum measurement theory as isometry charges have.
  - (a) The hint as how this description could be achieved comes from a long standing un-answered question motivated by the fact that electro-weak gauge group identifiable as the holonomy group of  $CP_2$  can be identified as  $U(2)$  subgroup of color group. Could the electro-weak charges be identified as classical color charges? This might make sense since the color charges have also identification as fermionic charges implied by quantum criticality. Or could electro-weak charges be only represented as classical color charges by mapping them to classical color currents in the measurement interaction term in the modified Dirac action? At least this question might make sense.

- (b) It does not make sense to couple both electro-weak and color charges to the same fermion current. There are also other fundamental fermion currents which are conserved. All the following currents are conserved.

$$\begin{aligned}
 J^\alpha &= \bar{\Psi} O \hat{\Gamma}^\alpha \Psi \\
 O &\in \{1, J \equiv J_{kl} \Sigma^{kl}, \Sigma_{AB}, \Sigma_{AB} J\}.
 \end{aligned} \tag{4.4.16}$$

Here  $J_{kl}$  is the covariantly constant  $CP_2$  Kähler form and  $\Sigma_{AB}$  is the (also covariantly) constant sigma matrix of  $M^4$  (flatness is absolutely essential).

- (c) Electromagnetic charge can be expressed as a linear combination of currents corresponding to  $O = 1$  and  $O = J$  and vectorial isospin current corresponds to  $J$ . It is natural to couple of electromagnetic charge to the the projection of Killing vector field of color hyper charge and coupling it to the current defined by  $O_{em} = a + bJ$ . This allows to interpret the puzzling finding that electromagnetic charge can be identified as anomalous color hyper-charge for induced spinor fields made already during the first years of TGD. There exist no conserved axial isospin currents in accordance with CVC and PCAC hypothesis which belong to the basic stuff of the hadron physics of old days.
- (d) Color charges would couple naturally to lepton and quark number current and the  $U(1)$  part of electro-weak charges to the  $n = 1$  multiple of quark current and  $n = 3$  multiple of the lepton current (note that leptons *resp.* quarks correspond to  $t = 0$  *resp.*  $t = \pm 1$  color partial waves). If electro-weak *resp.* couplings to  $H$ -chirality are proportional to 1 *resp.*  $\Gamma_9$ , the fermionic currents assigned to color and electro-weak charges can be regarded as independent. This explains why the possibility of both vectorial and axial couplings in 8-D sense does not imply the doubling of gauge bosons.
- (e) There is also an infinite variety of conserved currents obtained as the quantum critical deformations of the basic fermion currents identified above. This would allow in principle to couple an arbitrary number of observables to the geometry of the space-time sheet by mapping them to Cartan algebras of Poincare and color group for a particular conserved quantum critical current. Quantum criticality would therefore make possible classical space-time correlates of observables necessary for quantum measurement theory.
- (f) The coupling constants associated with the deformations would appear in the couplings. Quantum criticality ( $K \rightarrow K + f + \bar{f}$  condition) should predict the spectrum of these couplings. In the case of momentum the coupling would be proportional to  $\sqrt{G/\hbar_0} = kR/\hbar_0$  and  $k \sim 2^{11}$  should follow from quantum criticality. p-Adic coupling constant evolution should follow from the dependence on the scale of  $CD$  coming as powers of 2.
4. Quantum criticality implies fluctuations in long length and time scales and it is not surprising that quantum criticality is needed to produce a correlation between quantal degrees of freedom and macroscopic degrees of freedom. Note that quantum classical correspondence can be regarded as an abstract form of entanglement induced by the entanglement between quantum charges  $Q_A$  and fermion number type charges assignable to zero modes.
  5. Space-time sheets can have an arbitrary number of wormhole contacts so that the interpretation in terms of measurement theory coupling short and long length scales suggests that the measurement interaction terms are localizable at the wormhole throats. This would favor Chern-Simons term or possibly instanton term if reducible to Chern-Simons terms. The breaking of CP and T might relate to the fact that state function reductions performed in quantum measurements indeed induce dissipation and breaking of time reversal invariance.
  6. The experimental arrangement quite concretely splits the quantum state to a quantum superposition of space-time sheets such that each eigenstate of the measured observables in the superposition corresponds to different space-time sheet already before the realization of state function reduction. This relates interestingly to the question whether state function reduction really occurs or whether only a branching of wave function defined by WCW spinor field takes place as in multiverse interpretation in which different branches correspond to different observers. TGD inspired theory consciousness requires that state function reduction takes place. Maybe multiversalist might be able to find from this picture support for his own beliefs.

7. One can argue that "free will" appears not only at the level of quantum jumps but also as the possibility to select the observables appearing in the modified Dirac action dictating in turn the Kähler function defining the Kähler metric of WCW representing the "laws of physics". This need not to be the case. The choice of  $CD$  fixes  $M^2$  and the geodesic sphere  $S^2$ : this does not fix completely the choice of the quantization axis but by isometry invariance rotations and color rotations do not affect Kähler function for given  $CD$  and for a given type of Cartan algebra. In  $M^4$  degrees of freedom the possibility to select the observables in two manners corresponding to linear and cylindrical Minkowski coordinates could imply that the resulting Kähler functions are different. The corresponding Kähler metrics do not differ if the real parts of the Kähler functions associated with the two choices differ by a term  $f(Z) + \overline{f(Z)}$ , where  $Z$  denotes complex coordinates of WCW, the Kähler metric remains the same. The function  $f$  can depend also on zero modes. If this is the case then one can allow in given CD superpositions of WCW spinor fields for which the measurement interactions are different. This condition is expected to pose non-trivial constraints on the measurement action and quantize coupling parameters appearing in it.

#### New view about gravitational mass and matter antimatter asymmetry

The physical interpretation of the additional term in the modified Dirac action might force quite a radical revision of the ideas about matter and antimatter.

1. The term  $p_A \partial_\alpha m^A$  contracted with the fermion current is analogous to a gauge potential coupling to fermion number. Since the additional terms in the modified Dirac operator induce stringy propagation, a natural interpretation of the coupling to the induced spinor fields is in terms of gravitation. One might perhaps say that the measurement of four momentum induces gravitational interaction. Besides momentum components also color charges take the role of gravitational charges. As a matter fact, any observable takes this role via coupling to the projections of Killing vector fields of Cartan algebra. The analogy of color interactions with gravitational interactions is indeed one of the oldest ideas in TGD.
2. The coupling to four-momentum is through fermion number (both quark number and lepton number). For states with a vanishing fermion number isometry charges therefore vanish. In this framework matter antimatter asymmetry would be due to the fact that matter (antimatter) corresponds to positive (negative) energy parts of zero energy states for massive systems so that the contributions to the net gravitational four-momentum are of same sign. Could antimatter be unobservable to us because it resides at negative energy space-time sheets? As a matter fact, I proposed already years ago that gravitational mass is essentially the magnitude of the inertial mass but gave up this idea.
3. Bosons do not couple at all to gravitation if they are purely local bound states of fermion and anti-fermion at the same space-time sheet (say represented by generators of super Kac-Moody algebra). Therefore the only possible identification of gauge bosons is as wormhole contacts. If the fermion and anti-fermion at the opposite throats of the contact correspond to positive and negative energy states the net gravitational energy receives a positive contribution from both sheets. If both correspond to positive (negative) energy the contributions to the net four-momentum have opposite signs. It is not yet clear which identification is the correct one.

#### 4.4.4 Generalized eigenvalues of $D_{C-S}$ and General Coordinate Invariance

The fixing of light-like 3-surface to be the wormhole throat at which the signature of induced metric changes from Minkowskian to Euclidian corresponds to a convenient fixing of gauge. General Coordinate Invariance however requires that any light-like surface  $Y_l^3$  parallel to  $X_l^3$  in the slicing is equally good choice. In particular, it should give rise to same Kähler metric but not necessarily the same exponent of Kähler function identified as the product of the generalized eigenvalues of  $D_{C,S}$  at  $Y_l^3$ .

General Coordinate Invariance requires that the components of Kähler metric of configuration space defined in terms of Kähler function as

$$G_{k\bar{l}} = \partial_k \partial_{\bar{l}} K = \sum_i \partial_k \partial_{\bar{l}} \lambda_i$$

remain invariant under this flow. Here complex coordinate are of course associated with the configuration space. This is the case if the flow corresponds to the addition of sum of holomorphic function  $f(z)$  and its conjugate  $\overline{f(z)}$  which is anti-holomorphic function to  $K$ . This boils down to the scaling of eigenvalues  $\lambda_i$  by

$$\lambda_i \rightarrow \exp(f_i(z) + \overline{f_i(z)})\lambda_i . \quad (4.4.17)$$

If the eigenvalues are interpreted as vacuum conformal weights, general coordinate transformations correspond to a spectral flow scaling the eigenvalues in this manner. This in turn would induce spectral flow of ground state conformal weights if the squares of  $\lambda_i$  correspond to ground state conformal weights.

## 4.5 Super-conformal symmetries at space-time and configuration space level

The physical interpretation and detailed mathematical understanding of super-conformal symmetries has developed rather slowly and has involved several side tracks. In the following I try to summarize the basic picture with minimal amount of formulas with the understanding that the statement "Noether charge associated with geometrically realized Kac-Moody symmetry" is enough for the reader to write down the needed formula explicitly.

### 4.5.1 Configuration space as a union of symmetric spaces

In finite-dimensional context globally symmetric spaces are of form  $G/H$  and connection and curvature are independent of the metric, provided it is left invariant under  $G$ . The hope is that same holds true in infinite-dimensional context. The most one can hope of obtaining is the decomposition  $C(H) = \cup_i G/H_i$  over orbits of  $G$ . One could allow also symmetry breaking in the sense that  $G$  and  $H$  depend on the orbit:  $C(H) = \cup_i G_i/H_i$  but it seems that  $G$  can be chosen to be same for all orbits. What is essential is that these groups are infinite-dimensional. The basic properties of the coset space decomposition give very strong constraints on the group  $H$ , which certainly contains the subgroup of  $G$ , whose action reduces to diffeomorphisms of  $X^3$ .

#### Consequences of the decomposition

If the decomposition to a union of coset spaces indeed occurs, the consequences for the calculability of the theory are enormous since it suffices to find metric and curvature tensor for single representative 3-surface on a given orbit (contravariant form of metric gives propagator in perturbative calculation of matrix elements as functional integrals over the configuration space). The representative surface can be chosen to correspond to the maximum of Kähler function on a given orbit and one obtains perturbation theory around this maximum (Kähler function is not isometry invariant).

The task is to identify the infinite-dimensional groups  $G$  and  $H$  and to understand the zero mode structure of the configuration space. Almost twenty (seven according to long held belief!) years after the discovery of the candidate for the Kähler function defining the metric, it became finally clear that these identifications follow quite nicely from  $Diff^4$  invariance and  $Diff^4$  degeneracy as well as special properties of the Kähler action.

The guess (not the first one!) would be following.  $G$  corresponds to the symplectic transformations of  $\delta M_{\pm}^4 \times CP_2$  leaving the induced Kähler form invariant. If  $G$  acts as isometries the values of Kähler form at partonic 2-surfaces (remember effective 2-dimensionality) are zero modes and configuration space allows slicing to symplectic orbits of the partonic 2-surface with fixed induced Kähler form. Quantum fluctuating degrees of freedom would correspond to symplectic group and to the fluctuations of the induced metric. The group  $H$  dividing  $G$  would in turn correspond to the Kac-Moody symmetries respecting light-likeness of  $X_l^3$  and acting in  $X_l^3$  but trivially at the partonic 2-surface  $X^2$ . This coset structure was originally discovered via coset construction for super Virasoro algebras of super-symplectic and super Kac-Moody algebras and realizes Equivalence Principle at quantum level.



### Configuration space isometries as a subgroup of $Diff(\delta M_+^4 \times CP_2)$

The reduction to light cone boundary leads to the identification of the isometry group as some subgroup of for the group  $G$  for the diffeomorphisms of  $\delta M_+^4 \times CP_2$ . These diffeomorphisms indeed act in a natural manner in  $\delta CH$ , the the space of 3-surfaces in  $\delta M_+^4 \times CP_2$ . Configuration space is expected to decompose to a union of the coset spaces  $G/H_i$ , where  $H_i$  corresponds to some subgroup of  $G$  containing the transformations of  $G$  acting as diffeomorphisms for given  $X^3$ . Geometrically the vector fields acting as diffeomorphisms of  $X^3$  are tangential to the 3-surface.  $H_i$  could depend on the topology of  $X^3$  and since  $G$  does not change the topology of 3-surface each 3-topology defines separate orbit of  $G$ . Therefore, the union involves sum over all topologies of  $X^3$  plus possibly other 'zero modes'. Different topologies are naturally glued together since singular 3-surfaces intermediate between two 3-topologies correspond to points common to the two sectors with different topologies.

### 4.5.2 Isometries of configuration space geometry as symplectic transformations of $\delta M_+^4 \times CP_2$

During last decade I have considered several candidates for the group  $G$  of isometries of the configuration space as the sub-algebra of the subalgebra of  $Diff(\delta M_+^4 \times CP_2)$ . To begin with let us write the general decomposition of  $diff(\delta M_+^4 \times CP_2)$ :

$$diff(\delta M_+^4 \times CP_2) = S(CP_2) \times diff(\delta M_+^4) \oplus S(\delta M_+^4) \times diff(CP_2) . \quad (4.5.1)$$

Here  $S(X)$  denotes the scalar function basis of space  $X$ . This Lie-algebra is the direct sum of light cone diffeomorphisms made local with respect to  $CP_2$  and  $CP_2$  diffeomorphisms made local with respect to light cone boundary.

The idea that entire diffeomorphism group would act as isometries looks unrealistic since the theory should be more or less equivalent with topological field theory in this case. Consider now the various candidates for  $G$ .

1. The fact that symplectic transformations of  $CP_2$  and  $M_+^4$  diffeomorphisms are dynamical symmetries of the vacuum extremals suggests the possibility that the diffeomorphisms of the light cone boundary and symplectic transformations of  $CP_2$  could leave Kähler function invariant and thus correspond to zero modes. The symplectic transformations of  $CP_2$  localized with respect to light cone boundary acting as symplectic transformations of  $CP_2$  have interpretation as local color transformations and are a good candidate for the isometries. The fact that local color transformations are not even approximate symmetries of Kähler action is not a problem: if they were exact symmetries, Kähler function would be invariant and zero modes would be in question.
2.  $CP_2$  local conformal transformations of the light cone boundary act as isometries of  $\delta M_+^4$ . Besides this there is a huge group of the symplectic symmetries of  $\delta M_+^4 \times CP_2$  if light cone boundary is provided with the symplectic structure. Both groups must be considered as candidates for groups of isometries.  $\delta M_+^4 \times CP_2$  option exploits fully the special properties of  $\delta M_+^4 \times CP_2$ , and one can develop simple argument demonstrating that  $\delta M_+^4 \times CP_2$  symplectic invariance is the correct option. Also the construction of configuration space gamma matrices as super-symplectic charges supports  $\delta M_+^4 \times CP_2$  option.

This picture remained same for a long time. The discovery that Kac-Moody algebra consisting of  $X^2$  local symmetries generated by Hamiltonians of isometry sub-algebra of symplectic algebra forced to challenge this picture and ask whether also  $X^2$ -local transformations of symplectic group could be involved.

1. The basic condition is that the  $X^2$  local transformation acts leaves induced Kähler form invariant apart from diffeomorphism. Denote the infinitesimal generator of  $X^2$  local symplectomorphism by  $\Phi_A(x)j^{Ak}$ , where  $A$  labels Hamiltonians in the sum and by  $j^\alpha$  the generator of  $X^2$  diffeomorphism.
2. The invariance of  $J = \epsilon^{\alpha\beta} J_{\alpha\beta} \sqrt{g_2}$  modulo diffeomorphism under the infinitesimal symplectic transformation gives

$$\{H^A, \Phi_A\} \equiv \partial_\alpha H^A \epsilon^{\alpha\beta} \partial_\beta \Phi_A = \partial_\alpha J j^\alpha . \quad (4.5.2)$$

3. Note that here the Poisson bracket is not defined by  $J^\alpha\beta$  but  $\epsilon^{\alpha\beta}$  defined by the induced metric. Left hand side reflects the failure of symplectomorphism property due to the dependence of  $\Phi_A(x)$  on  $X^2$  coordinate which and comes from the gradients of  $\delta M^4 \times CP_2$  coordinates in the expression of the induced Kähler form. Right hand side corresponds to the action of infinitesimal diffeomorphism.
4. Let us assume that one can restrict the consideration to single Hamiltonian so that the transformation is generated by  $\Phi(x)H_A$  and that to each  $\Phi(x)$  there corresponds a diffeomorphism of  $X^2$ , which is a symplectic transformation of  $X^2$  with respect to symplectic form  $\epsilon^{\alpha\beta}$  and generated by Hamiltonian  $\Psi(x)$ . This transforms the invariance condition to

$$\{H^A, \Phi\} \equiv \partial_\alpha H^A \epsilon^{\alpha\beta} \partial_\beta \Phi = \partial_\alpha J \epsilon^{\alpha\beta} \partial_\beta \Psi_A = \{J, \Psi_A\} . \quad (4.5.3)$$

This condition can be solved identically by assuming that  $\Phi_A$  and  $\Psi$  are proportional to arbitrary smooth function of  $J$ :

$$\Phi = f(J) , \quad \Psi_A = -f(J)H_A . \quad (4.5.4)$$

Therefore the  $X^2$  local symplectomorphisms of  $H$  reduce to symplectic transformations of  $X^2$  with Hamiltonians depending on single coordinate  $J$  of  $X^2$ . The analogy with conformal invariance for which transformations depend on single coordinate  $z$  is obvious. As far as the anti-commutation relations for induced spinor fields are considered this means that  $J = \text{constant}$  curves behave as points. For extrema of  $J$  appearing as candidates for points of number theoretic braids  $J = \text{constant}$  curves reduce to points.

5. From the structure of the conditions it is easy to see that the transformations generate a Lie-algebra. For the transformations  $\Phi_A^1 H^A$   $\Phi_A^2 H^A$  the commutator is

$$\Phi_A^{[1,2]} = f_A^{BC} \Phi_B \Phi_C , \quad (4.5.5)$$

where  $f_A^{BC}$  are the structure constants for the symplectic algebra of  $\delta M_\pm^4 \times CP_2$ . From this form it is easy to check that Jacobi identities are satisfied. The commutator has same form as the commutator of gauge algebra generators. BRST gauge symmetry is perhaps the nearest analog of this symmetry. In the case of isometries these transforms realized local color gauge symmetry in TGD sense.

6. If space-time surface allows a slicing to light-like 3-surfaces  $Y_l^3$  parallel to  $X_l^3$ , these conditions make sense also for the partonic 2-surfaces defined by the intersections of  $Y_l^3$  with  $\delta M_\pm^4 \times CP_2$  and "parallel" to  $X^2$ . The local symplectic transformations also generalize to their local variants in  $X_l^3$ . Light-likeness of  $X_l^3$  means effective metric 2-dimensionality so that 2-D Kähler metric and symplectic form as well as the invariant  $J = \epsilon^{\alpha\beta} J_{\alpha\beta}$  exist. A straightforward calculation shows that the the notion of local symplectic transformation makes sense also now and formulas are exactly the same as above.

### 4.5.3 SUSY algebra defined by the anticommutation relations of fermionic oscillator operators and WCW local Clifford algebra elements as chiral super-fields

Whether TGD allows space-time supersymmetry has been a long-standing question. Majorana spinors appear in  $N = 1$  super-symmetric QFTs- in particular minimally super-symmetric standard model (MSSM). Majorana-Weyl spinors appear in M-theory and super string models. An undesirable consequence is chiral anomaly in the case that the numbers of left and right handed spinors are not same. For  $D = 11$  and  $D = 10$  these anomalies cancel which led to the breakthrough of string models and later to M-theory. The probable reason for considering these dimensions is that standard model does not predict right-handed neutrino (although neutrino mass suggests that right handed neutrino exists) so that the numbers of left and right handed Weyl-spinors are not the same.

In TGD framework the situation is different. Covariantly constant right-handed neutrino spinor acts as a super-symmetry in  $CP_2$ . One might think that right-handed neutrino in a well-defined sense disappears from the spectrum as a zero mode so that the number of right and left handed chiralities in  $M^4 \times CP_2$  would not be same. For light-like 3-surfaces covariantly constant right-handed neutrino does not however solve the counterpart of Dirac equation for a non-vanishing four-momentum and color quantum numbers of the physical state. Therefore it does not disappear from the spectrum anymore and one expects the same number of right and left handed chiralities.

In TGD framework the separate conservation of baryon and lepton numbers excludes Majorana spinors and also the the Minkowski signature of  $M^4 \times CP_2$  makes them impossible. The conclusion that TGD does not allow super-symmetry is however wrong. For  $\mathcal{N} = 2N$  Weyl spinors are indeed possible and if the number of right and left handed Weyl spinors is same super-symmetry is possible. In 8-D context right and left-handed fermions correspond to quarks and leptons and since color in TGD framework corresponds to  $CP_2$  partial waves rather than spin like quantum number, also the numbers of quark and lepton-like spinors are same.

The physical picture suggest a new kind of approach to super-symmetry in the sense that the anticommutations of fermionic oscillator operators associated with the modes of the induced spinor fields define a structure analogous to SUSY algebra. This means that  $\mathcal{N} = 2N$  SUSY with large  $N$  is in question allowing spins higher than two and also large fermion numbers. Recall that  $\mathcal{N} \leq 32$  is implied by the absence of spins higher than two and the number of real spinor components is  $N = 32$  also in TGD. The situation clearly differs from that encountered in super-string models and SUSYs and the large value of  $N$  allows to expect very powerful constraints on dynamics irrespective of the fact that SUSY is broken. Right handed neutrino modes define a sub-algebra for which the SUSY is only slightly broken by the absence of weak interactions and one could also consider a theory containing a large number of  $\mathcal{N} = 2$  super-multiplets corresponding to the addition of right-handed neutrinos and antineutrinos at the wormhole throat.

Masslessness condition is essential for super-symmetry and at the fundamental level it could be formulated in terms of modified gamma matrices using octonionic representation and assuming that they span local quaternionic sub-algebra at each point of the space-time sheet. SUSY algebra has standard interpretation with respect to spin and isospin indices only at the partonic 2-surfaces so that the basic algebra should be formulated at these surfaces. Effective 2-dimensionality would require that partonic 2-surfaces can be taken to be ends of any light-like 3-surface  $Y_l^3$  in the slicing of the region surrounding a given wormhole throat.

#### Super-algebra associated with the modified gamma matrices

Anti-commutation relations for fermionic oscillator operators associated with the induced spinor fields are naturally formulated in terms of the modified gamma matrices. Super-conformal symmetry suggests that the anti-commutation relations for the fermionic oscillator operators at light-like 3-surfaces or at their ends are most naturally formulated as anti-commutation relations for SUSY algebra. The resulting anti-commutation relations would fix the quantum TGD.

$$\begin{aligned} \{a_{n\alpha}^\dagger, a_{n\beta}\} &= D_{mn} D_{\alpha\beta} \ , \\ D &= (p^\mu + \sum_a Q_a^\mu) \hat{\sigma}^\mu \ . \end{aligned} \tag{4.5.6}$$

Here  $p^\mu$  and  $Q_a^\mu$  are space-time projections of momentum and color charges in Cartan algebra. Their action is purely algebraic. The anti-commutations are nothing but a generalization of the ordinary equal-time anticommutation relations for fermionic oscillator operators to a manifestly covariant form. The matrix  $D_{m,n}$  is expected to reduce to a diagonal form with a proper normalization of the oscillator operators. The experience with extended SUSY algebra suggest that the anti-commutators could contain additional central term proportional to  $\delta_{\alpha\beta}$ .

One can consider basically two different options concerning the definition of the super-algebra.

1. If the super-algebra is defined at the 3-D ends of the intersection of  $X^4$  with the boundaries of  $CD$ , the modified gamma matrices appearing in the operator  $D$  appearing in the anti-commutator are associated with Kähler action. If the generalized masslessness condition  $D^2 = 0$  holds true -as suggested already earlier- one can hope that no explicit breaking of super-symmetry takes place and elegant description of massive states as effectively massless states making also possible generalization of twistor is possible. One must however notice that also massive representatives of SUSY exist.
2. SUSY algebra could be also defined at 2-D ends of light-like 3-surfaces.

According to considerations of [?] these options are equivalent for a large class of space-time sheets. If the effective 3-dimensionality realized in the sense that the effective metric defined by the modified gamma matrices is degenerate, propagation takes place along 3-D light-like 3-surfaces. This condition definitely fails for string like objects.

One can realize the local Clifford algebra also by introducing theta parameters in the standard manner and the expressing a collection of local Clifford algebra element with varying values of fermion numbers (function of  $CD$  and  $CP_2$  coordinates) as a chiral super-field. The definition of a chiral super field requires the introduction of super-covariant derivatives. Standard form for the anti-commutators of super-covariant derivatives  $D_\alpha$  make sense only if they do not affect the modified gamma matrices. This is achieved if  $p_k$  acts on the position of the tip of  $CD$  (rather than internal coordinates of the space-time sheet).  $Q_a$  in turn must act on  $CP_2$  coordinates of the tip.

### Super-fields associated with WCW Clifford algebra

WCW local Clifford algebra elements possess definite fermion numbers and it is not physically sensible to super-pose local Clifford algebra elements with different fermion numbers. The extremely elegant formulation of super-symmetric theories in terms of super-fields encourages to ask whether the local Clifford algebra elements could allow expansion in terms of complex theta parameters assigned to various fermionic oscillator operator in order to obtain formal superposition of elements with different fermion numbers. One can also ask whether the notion of chiral super field might make sense.

The obvious question is whether it makes sense to assign super-fields with the modified gamma matrices.

1. Modified gamma matrices are not covariantly constant but this is not a problem since the action of momentum generators and color generators is purely algebraic space-time coordinates.
2. One can define the notion of chiral super-field also at the fundamental level. Chiral super-field would be continuation of the local Clifford algebra of associated with  $CD$  to a local Clifford algebra element associated with the union of  $CD$ s. This would allow elegant description of cm degrees of freedom, which are the most interesting as far as QFT limit is considered.
3. Kähler function of WCW as a function of complex coordinates could be extended to a chiral super-field defined in quantum fluctuation degrees of freedom. It would depend on zero modes too. Does also the latter dependence allow super-space continuation? Coefficients of powers of theta would correspond to fermionic oscillator operators. Does this function define the propagators of various states associated with light-like 3-surface? Configuration space complex coordinates would correspond to the modes of induced spinor field so that super-symmetry would be realized very concretely.

#### 4.5.4 Identification of Kac-Moody symmetries

The Kac-Moody algebra of symmetries acting as symmetries respecting the light-likeness of 3-surfaces plays a crucial role in the identification of quantum fluctuating configuration space degrees of freedom contributing to the metric.

##### Identification of Kac-Moody algebra

The generators of bosonic super Kac-Moody algebra leave the light-likeness condition  $\sqrt{g_3} = 0$  invariant. This gives the condition

$$\delta g_{\alpha\beta} \text{Cof}(g^{\alpha\beta}) = 0 , \quad (4.5.7)$$

Here  $\text{Cof}$  refers to matrix cofactor of  $g_{\alpha\beta}$  and summation over indices is understood. The conditions can be satisfied if the symmetries act as combinations of infinitesimal diffeomorphisms  $x^\mu \rightarrow x^\mu + \xi^\mu$  of  $X^3$  and of infinitesimal conformal symmetries of the induced metric

$$\delta g_{\alpha\beta} = \lambda(x)g_{\alpha\beta} + \partial_\mu g_{\alpha\beta} \xi^\mu + g_{\mu\beta} \partial_\alpha \xi^\mu + g_{\alpha\mu} \partial_\beta \xi^\mu . \quad (4.5.8)$$

##### Ansatz as an $X^3$ -local conformal transformation of imbedding space

Write  $\delta h^k$  as a super-position of  $X^3$ -local infinitesimal diffeomorphisms of the imbedding space generated by vector fields  $J^A = j^{A,k} \partial_k$ :

$$\delta h^k = c_A(x) j^{A,k} . \quad (4.5.9)$$

This gives

$$\begin{aligned} c_A(x) [D_k j_l^A + D_l j_k^A] \partial_\alpha h^k \partial_\beta h^l + 2\partial_\alpha c_A h_{kl} j^{A,k} \partial_\beta h^l \\ = \lambda(x)g_{\alpha\beta} + \partial_\mu g_{\alpha\beta} \xi^\mu + g_{\mu\beta} \partial_\alpha \xi^\mu + g_{\alpha\mu} \partial_\beta \xi^\mu . \end{aligned} \quad (4.5.10)$$

If an  $X^3$ -local variant of a conformal transformation of the imbedding space is in question, the first term is proportional to the metric since one has

$$D_k j_l^A + D_l j_k^A = 2h_{kl} . \quad (4.5.11)$$

The transformations in question includes conformal transformations of  $H_\pm$  and isometries of the imbedding space  $H$ .

The contribution of the second term must correspond to an infinitesimal diffeomorphism of  $X^3$  reducible to infinitesimal conformal transformation  $\psi^\mu$ :

$$2\partial_\alpha c_A h_{kl} j^{A,k} \partial_\beta h^l = \xi^\mu \partial_\mu g_{\alpha\beta} + g_{\mu\beta} \partial_\alpha \xi^\mu + g_{\alpha\mu} \partial_\beta \xi^\mu . \quad (4.5.12)$$

##### A rough analysis of the conditions

One could consider a strategy of fixing  $c_A$  and solving solving  $\xi^\mu$  from the differential equations. In order to simplify the situation one could assume that  $g_{ir} = g_{rr} = 0$ . The possibility to cast the metric in this form is plausible since generic 3-manifold allows coordinates in which the metric is diagonal.

1. The equation for  $g_{rr}$  gives

$$\partial_r c_A h_{kl} j^{A,k} \partial_r h^k = 0 . \quad (4.5.13)$$

The radial derivative of the transformation is orthogonal to  $X^3$ . No condition on  $\xi^\alpha$  results. If  $c_A$  has common multiplicative dependence on  $c_A = f(r)d_A$  by a one obtains

$$d_A h_{kl} j^{Ak} \partial_r h^k = 0 . \quad (4.5.14)$$

so that  $J^A$  is orthogonal to the light-like tangent vector  $\partial_r h^k X^3$  which is the counterpart for the condition that Kac-Moody algebra acts in the transversal degrees of freedom only. The condition also states that the components  $g_{ri}$  is not changed in the infinitesimal transformation.

It is possible to choose  $f(r)$  freely so that one can perform the choice  $f(r) = r^n$  and the notion of radial conformal weight makes sense. The dependence of  $c_A$  on transversal coordinates is constrained by the transversality condition only. In particular, a common scale factor having free dependence on the transversal coordinates is possible meaning that  $X^3$ - local conformal transformations of  $H$  are in question.

2. The equation for  $g_{ri}$  gives

$$\partial_r \xi^i = \partial_r c_A h_{kl} j^{Ak} h^{ij} \partial_j h^k . \quad (4.5.15)$$

The equation states that  $g_{ri}$  are not affected by the symmetry. The radial dependence of  $\xi^i$  is fixed by this differential equation. No condition on  $\xi^r$  results. These conditions imply that the local gauge transformations are dynamical with the light-like radial coordinate  $r$  playing the role of the time variable. One should be able to fix the transformation more or less arbitrarily at the partonic 2-surface  $X^2$ .

3. The three independent equations for  $g_{ij}$  give

$$\xi^\alpha \partial_\alpha g_{ij} + g_{kj} \partial_i \xi^k + g_{ki} \partial_j \xi^k = \partial_i c_A h_{kl} j^{Ak} \partial_j h^l . \quad (4.5.16)$$

These are 3 differential equations for 3 functions  $\xi^\alpha$  on 2 independent variables  $x^i$  with  $r$  appearing as a parameter. Note however that the derivatives of  $\xi^r$  do not appear in the equation. At least formally equations are not over-determined so that solutions should exist for arbitrary choices of  $c_A$  as functions of  $X^3$  coordinates satisfying the orthogonality conditions. If this is the case, the Kac-Moody algebra can be regarded as a local algebra in  $X^3$  subject to the orthogonality constraint.

This algebra contains as a subalgebra the analog of Kac-Moody algebra for which all  $c_A$  except the one associated with time translation and fixed by the orthogonality condition depends on the radial coordinate  $r$  only. The larger algebra decomposes into a direct sum of representations of this algebra.

### Commutators of infinitesimal symmetries

The commutators of infinitesimal symmetries need not be what one might expect since the vector fields  $\xi^\mu$  are functionals  $c_A$  and of the induced metric and also  $c_A$  depends on induced metric via the orthogonality condition. What this means that  $j^{A,k}$  in principle acts also to  $\phi_B$  in the commutator  $[c_A J^A, c_B J^B]$ .

$$[c_A J^A, c_B J^B] = c_{ACB} J^{[A,B]} + J^A \circ c_B J^B - J^B \circ c_A J^A , \quad (4.5.17)$$

where  $\circ$  is a short hand notation for the change of  $c_B$  induced by the effect of the conformal transformation  $J^A$  on the induced metric.

Luckily, the conditions in the case  $g_{rr} = g_{ir} = 0$  state that the components  $g_{rr}$  and  $g_{ir}$  of the induced metric are unchanged in the transformation so that the condition for  $c_A$  resulting from  $g_{rr}$  component of the metric is not affected. Also the conditions coming from  $g_{ir} = 0$  remain unchanged. Therefore the commutation relations of local algebra apart from constraint from transversality result.

The commutator algebra of infinitesimal symmetries should also close in some sense. The orthogonality to the light-like tangent vector creates here a problem since the commutator does not obviously satisfy this condition automatically. The problem can be solved by following the recipes of non-covariant quantization of string model.

1. Make a choice of gauge by choosing time translation  $P^0$  in a preferred  $M^4$  coordinate frame to be the preferred generator  $J^{A_0} \equiv P^0$ , whose coefficient  $\Phi_{A_0} \equiv \Psi(P^0)$  is solved from the orthogonality condition. This assumption is analogous with the assumption that time coordinate is non-dynamical in the quantization of strings. The natural basis for the algebra is obtained by allowing only a single generator  $J^A$  besides  $P^0$  and putting  $d_A = 1$ .
2. This prescription must be consistent with the well-defined radial conformal weight for the  $J^A \neq P^0$  in the sense that the proportionality of  $d_A$  to  $r^n$  for  $J^A \neq P^0$  must be consistent with commutators.  $SU(3)$  part of the algebra is of course not a problem. From the Lorentz vector property of  $P^k$  it is clear that the commutators resulting in a repeated commutation have well-defined radial conformal weights only if one restricts  $SO(3, 1)$  to  $SO(3)$  commuting with  $P^0$ . Also  $D$  could be allowed without losing well-defined radial conformal weights but the argument below excludes it. This picture conforms with the earlier identification of the Kac-Moody algebra.

Conformal algebra contains besides Poincare algebra and the dilation  $D = m^k \partial_{m^k}$  the mutually commuting generators  $K^k = (m^r m_r \partial_{m^k} - 2m^k m^l \partial_{m^l})/2$ . The commutators involving added generators are

$$\begin{aligned} [D, K^k] &= -K^k, & [D, P^k] &= P^k, \\ [K^k, K^l] &= 0, & [K^k, P^l] &= m^{kl} D - M^{kl}. \end{aligned} \tag{4.5.18}$$

From the last commutation relation it is clear that the inclusion of  $K^k$  would mean loss of well-defined radial conformal weights.

3. The coefficient  $dm^0/dr$  of  $\Psi(P^0)$  in the equation

$$\Psi(P^0) \frac{dm^0}{dr} = -J^{Ak} h_{kl} \partial_r h^l$$

is always non-vanishing due to the light-likeness of  $r$ . Since  $P^0$  commutes with generators of  $SO(3)$  (but not with  $D$  so that it is excluded!), one can *define* the commutator of two generators as a commutator of the remaining part and identify  $\Psi(P^0)$  from the condition above.

4. Of course, also the more general transformations act as Kac-Moody type symmetries but the interpretation would be that the sub-algebra plays the same role as  $SO(3)$  in the case of Lorentz group: that is gives rise to generalized spin degrees of freedom whereas the entire algebra divided by this sub-algebra would define the coset space playing the role of orbital degrees of freedom. In fact, also the Kac-Moody type symmetries for which  $c_A$  depends on the transversal coordinates of  $X^3$  would correspond to orbital degrees of freedom. The presence of these orbital degrees of freedom arranging super Kac-Moody representations into infinite multiplets labeled by function basis for  $X^2$  means that the number of degrees of freedom is much larger than in string models.
5. It is possible to replace the preferred time coordinate  $m^0$  with a preferred light-like coordinate. There are good reasons to believe that orbifold singularity for phases of matter involving non-standard value of Planck constant corresponds to a preferred light-ray going through the tip of  $\delta M^4_{\pm}$ . Thus it would be natural to assume that the preferred  $M^4$  coordinate varies along this light ray or its dual. The Kac-Moody group  $SO(3) \times E^3$  respecting the radial conformal weights would reduce to  $SO(2) \times E^2$  as in string models.  $E^2$  would act in tangent plane of  $S^2_{\pm}$  along this ray defining also  $SO(2)$  rotation axis.

### Hamiltonians

The action of these transformations on Kähler action is well-defined and one can deduce the conserved quantities having identification as configuration space Hamiltonians. Hamiltonians also correspond to closed 2-forms. The condition that the Hamiltonian reduces to a dual of closed 2-form is satisfied because  $X^2$ -local conformal transformations of  $M_{\pm}^4 \times CP_2$  are in question ( $X^2$ -locality does not imply any additional conditions).

### The action of Kac-Moody algebra on spinors and fermionic representations of Kac-Moody algebra

One can imagine two interpretations for the action of generalized Kac-Moody transformations on spinors.

1. The basic goal is to deduce the fermionic Noether charge associated with the bosonic Kac-Moody symmetry and this can be done by a standard recipe. The first contribution to the charge comes from the transformation of modified gamma matrices appearing in the modified Dirac action associated with fermions. Second contribution comes from spinor rotation.
2. Both  $SO(3)$  and  $SU(3)$  rotations have a standard action as spin rotation and electro-weak rotation allowing to define the action of the Kac-Moody algebra  $J^A$  on spinors.

### How central extension term could emerge?

The central extension term of Kac-Moody algebra could correspond to a symplectic extension which can emerge from the freedom to add a constant term to Hamiltonians as in the case of super-symplectic algebra. The expression of the Hamiltonians as closed forms could allow to understand how the central extension term emerges.

In principle one can construct a representation for the action of Kac-Moody algebra on fermions a representations as a fermionic bilinear and the central extension of Kac-Moody algebra could emerge in this construction just as it appears in Sugawara construction.

### About the interpretation of super Kac-Moody symmetries

Also the light like 3-surfaces  $X_l^3$  of  $H$  defining elementary particle horizons at which Minkowskian signature of the metric is changed to Euclidian and boundaries of space-time sheets can act as causal determinants, and thus contribute to the configuration space metric. In this case the symmetries correspond to the isometries of the imbedding space localized with respect to the complex coordinate of the 2-surface  $X^2$  determining the light like 3-surface  $X_l^3$  so that Kac-Moody type symmetry results. Also the condition  $\sqrt{g_3} = 0$  for the determinant of the induced metric seems to define a conformal symmetry associated with the light like direction.

If is enough to localize only the  $H$ -isometries with respect to  $X_l^3$ , the purely bosonic part of the Kac-Moody algebra corresponds to the isometry group  $M^4 \times SO(3, 1) \times SU(3)$ . The physical interpretation of these symmetries is not so obvious as one might think. The point is that one can generalize the formulas characterizing the action of infinitesimal isometries on spinor fields of finite-dimensional Kähler manifold to the level of the configuration space. This gives rise to bosonic generators containing also a sigma-matrix term bilinear in fermionic oscillator operators. This representation need not be equivalent with the purely fermionic representations provided by induced Dirac action. Thus one has two groups of local color charges and the challenge is to find a physical interpretation for them.

The following arguments support one possible identification.

1. The hint comes from the fact that  $U(2)$  in the decomposition  $CP_2 = SU(3)/U(2)$  corresponds in a well-defined sense electro-weak algebra identified as a holonomy algebra of the spinor connection. Hence one could argue that the  $U(2)$  generators of either  $SU(3)$  algebra might be identifiable as generators of local  $U(2)_{ew}$  gauge transformations whereas non-diagonal generators would correspond to Higgs field. This interpretation would conform with the idea that Higgs field is a genuine scalar field rather than a composite of fermions.



2. Since  $X_l^3$ -local  $SU(3)$  transformations represented by fermionic currents are characterized by central extension they would naturally correspond to the electro-weak gauge algebra and Higgs bosons. This is also consistent with the fact that both leptons and quarks define fermionic Kac Moody currents.
3. The fact that only quarks appear in the gamma matrices of the configuration space supports the view that action of the generators of  $X_l^3$ -local color transformations on configuration space spinor fields represents local color transformations. If the action of  $X_l^3$ -local  $SU(3)$  transformations on configuration space spinor fields has trivial central extension term the identification as a representation of local color symmetries is possible.

The topological explanation of the family replication phenomenon is based on an assignment of 2-dimensional boundary to a 3-surface characterizing the elementary particle. The precise identification of this surface has remained open and one possibility is that the 2-surface  $X^2$  defining the light-like surface associated with an elementary particle horizon is in question. This assumption would conform with the notion of elementary particle vacuum functionals defined in the zero modes characterizing different conformal equivalence classes for  $X^2$ .

### The relationship of the Super-Kac Moody symmetry to the standard super-conformal invariance

Super-Kac Moody symmetry can be regarded as  $N = 4$  complex super-symmetry with complex  $H$ -spinor modes of  $H$  representing the 4 physical helicities of 8-component leptonic and quark like spinors acting as generators of complex dynamical super-symmetries. The super-symmetries generated by the covariantly constant right handed neutrino appear with *both*  $M^4$  helicities: it however seems that covariantly constant neutrino does not generate any global super-symmetry in the sense of particle-particle mass degeneracy. Only righthanded neutrino spinor modes (apart from covariantly constant mode) appear in the expressions of configuration space gamma matrices forming a subalgebra of the full super-algebra.

$N = 2$  real super-conformal algebra is generated by the energy momentum tensor  $T(z)$ ,  $U(1)$  current  $J(z)$ , and super generators  $G^\pm(z)$  carrying  $U(1)$  charge. Now  $U(1)$  current would correspond to right-handed neutrino number and super generators would involve contraction of covariantly constant neutrino spinor with second quantized induced spinor field. The further facts that  $N = 2$  algebra is associated naturally with Kähler geometry, that the partition functions associated with  $N = 2$  super-conformal representations are modular invariant, and that  $N = 2$  algebra defines so called chiral ring defining a topological quantum field theory [?], lend a further support for the belief that  $N = 2$  super-conformal algebra acts in super-symplectic degrees of freedom.

The values of  $c$  and conformal weights for  $N = 2$  super-conformal field theories are given by

$$\begin{aligned}
 c &= \frac{3k}{k+2} , \\
 \Delta_{l,m}(NS) &= \frac{l(l+2) - m^2}{4(k+2)} , \quad l = 0, 1, \dots, k , \\
 q_m &= \frac{m}{k+2} , \quad m = -l, -l+2, \dots, l-2, l .
 \end{aligned} \tag{4.5.19}$$

$q_m$  is the fractional value of the  $U(1)$  charge, which would now correspond to a fractional fermion number. For  $k = 1$  one would have  $q = 0, 1/3, -1/3$ , which brings in mind anyons.  $\Delta_{l=0, m=0} = 0$  state would correspond to a massless state with a vanishing fermion number. Note that  $SU(2)_k$  Wess-Zumino model has the same value of  $c$  but different conformal weights. More information about conformal algebras can be found from the appendix of [?].

For Ramond representation  $L_0 - c/24$  or equivalently  $G_0$  must annihilate the massless states. This occurs for  $\Delta = c/24$  giving the condition  $k = 2 [l(l+2) - m^2]$  (note that  $k$  must be even and that  $(k, l, m) = (4, 1, 1)$  is the simplest non-trivial solution to the condition). Note the appearance of a fractional vacuum fermion number  $q_{vac} = \pm c/12 = \pm k/4(k+2)$ . I have proposed that NS and Ramond algebras could combine to a larger algebra containing also lepto-quark type generators but this not necessary.

The conformal algebra defined as a direct sum of Ramond and NS  $N = 4$  complex sub-algebras associated with quarks and leptons might further extend to a larger algebra if lepto-quark generators acting effectively as half odd-integer Virasoro generators can be allowed. The algebra would contain spin and electro-weak spin as fermionic indices. Poincare and color Kac-Moody generators would act as symplectically extended isometry generators on configuration space Hamiltonians expressible in terms of Hamiltonians of  $X_l^3 \times CP_2$ . Electro-weak and color Kac-Moody currents have conformal weight  $h = 1$  whereas  $T$  and  $G$  have conformal weights  $h = 2$  and  $h = 3/2$ .

The experience with  $N = 4$  complex super-conformal invariance suggests that the extended algebra requires the inclusion of also second quantized induced spinor fields with  $h = 1/2$  and their super-partners with  $h = 0$  and realized as fermion-antifermion bilinears. Since  $G$  and  $\Psi$  are labeled by  $2 \times 4$  spinor indices, super-partners would correspond to  $2 \times (3 + 1) = 8$  massless electro-weak gauge boson states with polarization included. Their inclusion would make the theory highly predictive since induced spinor and electro-weak fields are the fundamental fields in TGD.

#### 4.5.5 Coset space structure for configuration space as a symmetric space

The key ingredient in the theory of symmetric spaces is that the Lie-algebra of  $G$  has the following decomposition

$$g = h + t \ , \\ [h, h] \subset h \ , \quad [h, t] \subset t \ , \quad [t, t] \subset h \ .$$

In present case this has highly nontrivial consequences. The commutator of *any* two infinitesimal generators generating nontrivial deformation of 3-surface belongs to  $h$  and thus vanishing norm in the configuration space metric at the point which is left invariant by  $H$ . In fact, this same condition follows from Ricci flatness requirement and guarantees also that  $G$  acts as isometries of the configuration space. This generalization is supported by the properties of the unitary representations of Lorentz group at the light cone boundary and by number theoretical considerations.

The algebras suggesting themselves as candidates are symplectic algebra of  $\delta M^\pm \times CP_2$  and Kac-Moody algebra mapping light-like 3-surfaces to light-like 3-surfaces to be discussed in the next section.

The identification of the precise form of the coset space structure is however somewhat delicate.

1. The essential point is that both symplectic and Kac-Moody algebras allow representation in terms of  $X_l^3$ -local Hamiltonians. The general expression for the Hamilton of Kac-Moody algebra is

$$H = \sum \Phi_A(x) H^A \ . \quad (4.5.20)$$

Here  $H^A$  are Hamiltonians of  $SO(3) \times SU(3)$  acting in  $\delta X_l^3 \times CP_2$ . For symplectic algebra any Hamiltonian is allowed. If  $x$  corresponds to any point of  $X_l^3$ , one must assume a slicing of the causal diamond  $CD$  by translates of  $\delta M_\pm^4$ .

2. For symplectic generators the dependence of form on  $r^\Delta$  on light-like coordinate of  $\delta X_l^3 \times CP_2$  is allowed.  $\Delta$  is complex parameter whose modulus squared is interpreted as conformal weight.  $\Delta$  is identified as analogous quantum number labeling the modes of induced spinor field.
3. One can wonder whether the choices of the  $r_M = \text{constant}$  sphere  $S^2$  is the only choice. The Hamiltonin-Jacobi coordinate for  $X_{X_l^3}^4$  suggest an alternative choice as  $E^2$  in the decomposition of  $M^4 = M^2(x) \times E^2(x)$  required by number theoretical compactification and present for known extremals of Kähler action with Minkowskian signature of induced metric. In this case  $SO(3)$  would be replaced with  $SO(2)$ . It however seems that the radial light-like coordinate  $u$  of  $X^4(X_l^3)$  would remain the same since any other curve along light-like boundary would be space-like.
4. The vector fields for representing Kac-Moody algebra must vanish at the partonic 2-surface  $X^2 \subset \delta M_\pm^4 \times CP_2$ . The corresponding vector field must vanish at each point of  $X^2$ :

$$j^k = \sum \Phi_A(x) J^{kl} H_l^A = 0 . \quad (4.5.21)$$

This means that the vector field corresponds to  $SO(2) \times U(2)$  defining the isotropy group of the point of  $S^2 \times CP_2$ .

This expression could be deduced from the idea that the surfaces  $X^2$  are analogous to origin of  $CP_2$  at which  $U(2)$  vector fields vanish. Configuration space at  $X^2$  could be also regarded as the analog of the origin of local  $S^2 \times CP_2$ . This interpretation is in accordance with the original idea which however was given up in the lack of proper realization. The same picture can be deduced from braiding in which case the Kac-Moody algebra corresponds to local  $SO(2) \times U(2)$  for each point of the braid at  $X^2$ . The condition that Kac-Moody generators with positive conformal weight annihilate physical states could be interpreted by stating effective 2-dimensionality in the sense that the deformations of  $X_l^3$  preserving its light-likeness do not affect the physics. Note however that Kac-Moody type Virasoro generators do not annihilate physical states.

5. Kac-Moody algebra generator must leave induced Kähler form invariant at  $X^2$ . This is of course trivial since the action leaves each point invariant. The conditions of Cartan decomposition are satisfied. The commutators of the Kac-Moody vector fields with symplectic generators are non-vanishing since the action of symplectic generator on Kac-Moody generator restricted to  $X^2$  gives a non-vanishing result belonging to the symplectic algebra. Also the commutators of Kac-Moody generators are Kac-Moody generators.

#### 4.5.6 The relationship between super-symplectic and Super Kac-Moody algebras, Equivalence Principle, and justification of p-adic thermodynamics

The relationship between super-symplectic algebra ( $SS$ ) acting at light-cone boundary and Super Kac-Moody algebra ( $SKM$ ) acting on light-like 3-surfaces has remained somewhat enigmatic due to the lack of physical insights. This is not the only problem. The question to precisely what extent Equivalence Principle (EP) remains true in TGD framework and what might be the precise mathematical realization of EP is waiting for an answer. Also the justification of p-adic thermodynamics for the scaling generator  $L_0$  of Virasoro algebra -in obvious conflict with the basic wisdom that this generator should annihilate physical states- is lacking. It seems that these three problems could have a common solution.

##### New vision about the relationship between $SSV$ and $SKMV$

Consider now the new vision about the relationship between  $SSV$  and  $SKMV$ .

1. The isometries of  $H$  assignable with  $SKM$  are also symplectic transformations [?] (note that I have used the attribute "canonical" instead of "symplectic" previously). Hence might consider the possibility that  $SKM$  could be identified as a subalgebra of  $SS$ . If this makes sense, a generalization of the coset construction obtained by replacing finite-dimensional Lie group with infinite-dimensional symplectic group suggests itself. The differences of  $SSV$  and  $SKMV$  elements would annihilate physical states and commute/anticommute with  $SKMV$ . Also the generators  $O_n$ ,  $n > 0$ , for both algebras would annihilate the physical states so that the differences of the elements would annihilate automatically physical states for  $n > 0$ .
2. The super-generator  $G_0$  contains the Dirac operator  $D$  of  $H$ . If the action of  $SSV$  and  $SKMV$  Dirac operators on physical states are identical then cm of degrees of freedom disappear from the differences  $G_0(SCV) - G_0(SKMV)$  and  $L_0(SCV) - L_0(SKMV)$ . One could interpret the identical action of the Dirac operators as the long sought-for precise realization of Equivalence Principle (EP) in TGD framework. EP would state that the total inertial four-momentum and color quantum numbers assignable to  $SS$  (imbedding space level) are equal to the gravitational four-momentum and color quantum numbers assignable to  $SKM$  (space-time level). Note that since super-symplectic transformations correspond to the isometries of the "world of classical worlds" the assignment of the attribute "inertial" to them is natural.

### Consistency with p-adic thermodynamics

The consistency with p-adic thermodynamics provides a strong reality test and has been already used as a constraint in attempts to understand the super-conformal symmetries in partonic level.

1. In physical states the p-adic thermal expectation value of the  $SKM$  and  $SS$  conformal weights would be non-vanishing and identical and mass squared could be identified equivalently either as the expectation value of  $SKM$  or  $SS$  scaling generator  $L_0$ . There would be no need to give up Super Virasoro conditions for  $SCV - SKMV$ .
2. There is consistency with p-adic mass calculations for hadrons [K46] since the non-perturbative  $SS$  contributions and perturbative  $SKM$  contributions to the mass correspond to space-time sheets labeled by different p-adic primes. The earlier statement that  $SS$  is responsible for the dominating non-perturbative contributions to the hadron mass transforms to a statement reflecting  $SS-SKM$  duality. The perturbative quark contributions to hadron masses can be calculated most conveniently by using p-adic thermodynamics for  $SKM$  whereas non-perturbative contributions to hadron masses can be calculated most conveniently by using p-adic thermodynamics for  $SS$ . Also the proposal that the exotic analogs of baryons resulting when baryon loses its valence quarks [K43] remains intact in this framework.
3. The results of p-adic mass calculations depend crucially on the number  $N$  of tensor factors contributing to the Super-Virasoro algebra. The required number is  $N = 5$  and during years I have proposed several explanations for this number. It seems that holonomic contributions that is electro-weak and spin contributions must be regarded as contributions separate from those coming from isometries.  $SKM$  algebras in electro-weak degrees and spin degrees of freedom, would give  $2+1=3$  tensor factors corresponding to  $U(2)_{ew} \times SU(2)$ .  $SU(3)$  and  $SO(3)$  (or  $SO(2) \subset SO(3)$  leaving the intersection of light-like ray with  $S^2$  invariant) would give 2 additional tensor factors. Altogether one would indeed have 5 tensor factors.

There are some further questions which pop up in mind immediately.

1. Why mass squared corresponds to the thermal expectation value of the net conformal weight? This option is forced among other things by Lorentz invariance but it is not possible to provide a really satisfactory answer to this question yet. In the coset construction there is no reason to require that the mass squared equals to the integer value conformal weight for  $SKM$  algebra. This allows the possibility that mass squared has same value for states with different values of  $SKM$  conformal weights appearing in the thermal state and equals to the average of the conformal weight.
2. The coefficient of proportionality can be however deduced from the observation that the mass squared values for  $CP_2$  Dirac operator correspond to definite values of conformal weight in p-adic mass calculations. It is indeed possible to assign to partonic 2-surface  $X^2$   $CP_2$  partial waves correlating strongly with the net electro-weak quantum numbers of the parton so that the assignment of ground state conformal weight to  $CP_2$  partial waves makes sense.
3. In the case of  $M^4$  degrees of freedom it is strictly speaking not possible to talk about momentum eigen states since translations take parton out of  $\delta H_+$ . This would suggest that 4-momentum must be assigned with the tip of the light-cone containing the particle but this is not consistent with zero energy ontology. Hence it seems that one must restrict the translations of  $X_l^3$  to time like translations in the direction of geometric future at  $\delta M_+^4 \times CP_2$ . The decomposition of the partonic 3-surface  $X_l^3$  to regions  $X_{l,i}^3$  carrying non-vanishing induced Kähler form and the possibility to assign  $M^2(x) \subset M^4$  to the tangent space of  $X^4(X_l^3)$  at points of  $X_l^3$  suggests that the points of number theoretic braid to which oscillator operators can be assigned can carry four-momentum in the plane defined by  $M^2(x)$ . One could assume that the four-momenta assigned with points in given region  $X_l^3$  are collinear but even this restriction is not necessary.
4. The additivity of conformal weight means additivity of mass squared at parton level and this has been indeed used in p-adic mass calculations. This implies the conditions

$$\left(\sum_i p_i\right)^2 = \sum_i m_i^2 \quad (4.5.22)$$

The assumption  $p_i^2 = m_i^2$  makes sense only for massless partons moving collinearly. In the QCD based model of hadrons only longitudinal momenta and transverse momentum squared are used as labels of parton states, which together with the presence of preferred plane  $M^2$  would suggest that one has

$$\begin{aligned} p_{i,\parallel}^2 &= m_i^2, \\ -\sum_i p_{i,\perp}^2 + 2\sum_{i,j} p_i \cdot p_j &= 0. \end{aligned} \quad (4.5.23)$$

The masses would be reduced in bound states:  $m_i^2 \rightarrow m_i^2 - (p_T^2)_i$ . This could explain why massive quarks can behave as nearly massless quarks inside hadrons.

#### How it is possible to have negative conformal weights for ground states?

p-Adic mass calculations require negative conformal weights for ground states [K39]. The only elegant solution of the problems caused by this requirement seems to be p-adic: the conformal weights are positive in the real sense but as p-adic numbers their dominating part is negative integer (in the real sense), which can be compensated by the conformal weights of Super Virasoro generators.

1. If  $\pm\lambda_i^2$  as such corresponds to a ground state conformal weight and if  $\lambda_i$  is real the ground state conformal weight positive in the real sense. In complex case (instanton term) the most natural formula is  $h = \pm|\lambda|^2$ .
2. The first option is based on the understanding of conformal excitations in terms of CP breaking instanton term added to the modified Dirac operator. In this case the conformal weights are identified as  $h = n - |\lambda_k|^2$  and the minus sign comes from the Euclidian signature of the effective metric for the modified Dirac operator. Ground state conformal weight would be non-vanishing for non-zero modes of  $D(X_i^3)$ . Massless bosons produce difficulties unless one has  $h = |\lambda_i(1) - \lambda_i(2)|^2$ , where  $i = 1, 2$  refers to the two wormhole throats. In this case the difference can vanish and its non-vanishing would be due to the symmetric breaking. This scenario is assumed in p-adic mass calculations. Fermions are predicted to be always massive since zero modes of  $D(X^2)$  represent super gauge degrees of freedom.
3. In the context of p-adic thermodynamics a loop hole opens allowing  $\lambda_i$  to be real. In spirit of rational physics suppose that one has in natural units  $h = \lambda_i^2 = xp^2 - n$ , where  $x$  is integer. This number is positive and large in the real sense. In p-adic sense the dominating part of this number is  $-n$  and can be compensated by the net conformal weight  $n$  of Super Virasoro generators acting on the ground state.  $xp^2$  represents the small Higgs contribution to the mass squared proportional to  $(xp^2)_R \simeq x/p^2$  ( $R$  refers to canonical identification). By the basic features of the canonical identification  $p > x \simeq p$  should hold true for gauge bosons for which Higgs contribution dominates. For fermions  $x$  should be small since p-adic mass calculations are consistent with the vanishing of Higgs contribution to the fermion mass. This would lead to the earlier conclusion that  $xp^2$  and hence  $B_K$  is large for bosons and small for fermions and that the size of fermionic (bosonic) wormhole throat is large (small). This kind of picture is consistent with the p-adic modular arithmetics and suggests by the cutoff for conformal weights implied by the fact that both the number of fermionic oscillator operators and the number of points of number theoretic braid are finite. This solution is however tricky and does not conform with number theoretical universality.

## 4.6 Trying to understand $N = 4$ super-conformal symmetry

The original idea was that  $N = 4$  super-conformal symmetry is a symmetry generated by the solutions of the modified Dirac equation for the second quantized induced spinor fields. Later I was ended up with this symmetry by considering the general structure of these algebras interpreted in TGD framework. In the following the latter approach is discussed in detail.

Needless to say, a lot remains to be understood. One of the problems is that my understanding of  $N = 4$  super-conformal symmetry at technical level is rather modest. There are also profound differences between these two kinds of super conformal symmetries. In TGD framework super generators carry quark or lepton number, super-symplectic and super Kac-Moody generators are identified as Hamiltonians rather than vector fields, and symplectic group is infinite-dimensional whereas the Lie groups associated with Kac-Moody algebras are finite-dimensional. On the other hand, finite measurement resolution implies discretization and cutoff in conformal weight. Therefore the naive attempt to re-interpret results of standard super-conformal symmetry to TGD framework might lead to erratic conclusions.

$N > 0$  super-conformal algebras contain besides super Virasoro generators also other types of generators and this raises the question whether it might be possible to find an algebra coding the basic quantum numbers of the induced spinor fields.

There are several variants of  $N = 4$  SCAs and they correspond to the Kac-Moody algebras  $SU(2)$  (small SCA),  $SU(2) \times SU(2) \times U(1)$  (large SCA) and  $SU(2) \times U(1)^4$ . Rasmussen has found also a fourth variant based on  $SU(2) \times U(1)$  Kac-Moody algebra [?]. It seems that only minimal and maximal  $N = 4$  SCAs can represent realistic options. The reduction to almost topological string theory in critical phase is probably lost for other than minimal SCA but could result as an appropriate limit for other variants.

It must be emphasized that the discussion of this section is not based on the recent view about generalization of space-time supersymmetry to TGD framework in which fermionic oscillator operators define an infinite-dimensional super-symmetry algebra with anticommutators fixed by the measurement interaction term of the modified Dirac action [?]. Therefore the direction connection with quantum TGD remains loose.

### 4.6.1 Large $N = 4$ SCA

Large  $N = 4$  SCA is described in the following in detail since it might be a natural algebra in TGD framework.

#### The structure of large $N = 4$ SCA algebra

Large  $N = 4$  super-conformal symmetry with  $SU(2)_+ \times SU(2)_- \times U(1)$  inherent Kac-Moody symmetry correspond to a fundamental partonic super-conformal symmetry in TGD framework.

A concise discussion of this symmetry with explicit expressions of commutation and anticommutation relations can be found in [?]. The representations of SCA are characterized by three central extension parameters for Kac-Moody algebras but only two of them are independent and given by

$$\begin{aligned} k_{\pm} &\equiv k(SU(2)_{\pm}) , \\ k_1 &\equiv k(U(1)) = k_+ + k_- . \end{aligned} \quad (4.6.1)$$

The central extension parameter  $c$  is given as

$$c = \frac{6k_+k_-}{k_+ + k_-} . \quad (4.6.2)$$

and is rational valued as required.

A much studied  $N = 4$  SCA corresponds to the special case

$$\begin{aligned} k_- &= 1 , \quad k_+ = k + 1 , \quad k_1 = k + 2 , \\ c &= \frac{6(k+1)}{k+2} . \end{aligned} \quad (4.6.3)$$

$c = 0$  would correspond to  $k_+ = 0, k_- = 1, k_1 = 1$ . For  $k_+ > 0$  one has  $k_1 = k_+ + k_- \neq k_+$ .

### About unitary representations of large $N = 4$ SCA

The unitary representations of large  $N = 4$  SCA are briefly discussed in [?] . The representations are labeled by the ground state conformal weight  $h$ ,  $SU(2)$  spins  $l_+, l_-$ , and  $U(1)$  charge  $u$ . Besides the inherent Kac-Moody algebra there is also "external" Kac-Moody group  $G$  involved and could correspond in TGD framework to the symplectic algebra associated with  $\delta H_{\pm} = \delta M_{\pm}^4 \times CP_2$  or to Kac-Moody group respecting light-likeness of light-like 3-surfaces.

Unitarity constraints apply completely generally irrespective of  $G$  so that one can apply them also in TGD framework. There are two kinds of unitary representations.

1. Generic/long/massive representations which are generated from vacuum state as usual. In this case there are no null vectors.
2. Short or massless representations have a null vector. The expression for the conformal weight  $h_{short}$  of the null vector reads in terms of  $l_+, l_-$  and  $k_+, k_-$  as

$$h_{short} = \frac{1}{k_+ + k_-} (k_- l_+ + k_+ l_- + (l_+ - l_-)^2 + u^2) . \quad (4.6.4)$$

Unitarity demands that both short and long representations lie at or above  $h \geq h_{short}$  and that spins lie in the range  $l_{\pm} = 0, 1/2, \dots, (k_{\pm} - 1)/2$ .

Interesting examples of  $N = 4$  SCA are provided by WZW coset models  $\mathcal{W} \times U(1)$ , where  $\mathcal{W}$  is WZW model associated with a quaternionic (Wolf) space. Examples based on classical groups are  $\mathcal{W} = G/H = SU(n)/SU(n-1) \times U(1)$ ,  $SO(n)/SO(n-4) \times SU(2)$ , and  $Sp(2n)/Sp(2n-2)$ . For  $n = 3$  first series gives  $CP_2$  whereas second series gives for  $n = 4$   $SO(4)/SU(2) = SU(2)$ . In this case one has  $k_+ = \kappa + 1$ , and  $k_- = \hat{c}_G$ , where  $\kappa$  is the level of the bosonic current algebra for  $G$  and  $\hat{c}_G$  is its dual Coxeter number.

### 4.6.2 Overall view about how different $N = 4$ SCAs could emerge in TGD framework

The basic idea is simple  $N = 4$  fermion states obtained as different combinations of spin and isospin for given  $H$ -chirality of imbedding space spinor correspond to  $N = 4$  multiplet. In case of leptons the holonomy group of  $S^2 \times CP_2$  for given spinor chirality is  $SU(2)_R \times SU(2)_R$  or  $SU(2)_L \times SU(2)_R$  depending on  $M^4$  chirality of the spinor. In case of quark one has  $SU(2)_L \times SU(2)_L$  or  $SU(2)_R \times SU(2)_R$ . The coupling to Kähler gauge potential adds to the group  $U(1)$  factor so that large  $N = 4$  SCA is obtained. For covariantly constant right handed neutrino electro-weak part of holonomy group drops away as also  $U(1)$  factor so that one obtains  $SU(2)_L$  or  $SU(2)_R$  and small  $N = 4$  SCA.

#### How maximal $N = 4$ SCA could emerge in TGD framework?

Consider the Kac-Moody algebra  $SU(2) \times SU(2) \times U(1)$  associated with the maximal  $N = 4$  SCA. Besides Kac-Moody currents it contains 4 spin 1/2 fermions having an identification as quantum counterparts of leptonic spinor fields. The interpretation of the first  $SU(2)$  is as rotations as rotations leaving invariant the sphere  $S^2 \subset \delta M_{\pm}^4$ .  $U(2)$  has interpretation as electro-weak gauge group and as maximal linearly realized subgroup of  $SU(3)$ . This algebra acts naturally as symmetries of the 8-component spinors representing super partners of quaternions.

The algebra involves the integer value central extension parameters  $k_+$  and  $k_-$  associated with the two  $SU(2)$  algebras as parameters. The value of  $U(1)$  central extension parameter  $k$  is given by  $k = k_+ + k_-$ . The value of central extension parameter  $c$  is given by

$$c = 6k_- \frac{x}{1+x} < 6k_+ , \quad x = \frac{k_+}{k_-} .$$

$c$  can have all non-negative rational values  $m/n$  for positive values of  $k_{\pm}$  given by  $k_+ = rm, k_- = (6nr - 1)m$ . Unitarity might pose further restrictions on the values of  $c$ . At the limit  $k_- = k, k_+ \rightarrow \infty$  the algebra reduces to the minimal  $N = 4$  SCA with  $c = 6k$  since the contributions from the second  $SU(2)$  and  $U(1)$  to super Virasoro currents vanish at this limit.

### How small $N = 4$ SCA could emerge in TGD framework?

Consider the TGD based interpretation of the small  $N = 4$  SCA.

1. The group  $SU(2)$  associated with the small  $N = 4$  SCA and acting as rotations of covariantly constant right-handed neutrino spinors allows also an interpretation as a group  $SO(3)$  leaving invariant the sphere  $S^2$  of the light-cone boundary identified as  $r_M = m^0 = \text{constant}$  surface defining generalized Kähler and symplectic structures in  $\delta M_{\pm}^4$ . Electro-weak degrees of freedom are obviously completely frozen so that  $SU(2)_- \times U(1)$  factor indeed drops out.
2. The choice of the preferred coordinate system should have a physical justification. The interpretation of  $SO(3)$  as the isotropy group of the rest system defined by the total four-momentum assignable to the 3-surface containing partonic 2-surfaces is supported by the quantum classical correspondence. The subgroup  $U(1)$  of  $SU(2)$  acts naturally as rotations around the axis defined by the light ray from the tip of  $M_{\pm}^4$  orthogonal to  $S^2$ . For  $c = 0, k = 0$  case these groups define local gauge symmetries. In the more general case local gauge invariance is broken whereas global invariance remains as it should.

In  $M^2 \times E^2$  decomposition  $E^2$  corresponds to the tangent space of  $S^2$  at a given point and  $M^2$  to the plane orthogonal to it. The natural assumption is that the right handed neutrino spinor is annihilated by the momentum space Dirac operator corresponding to the light-like momentum defining  $M^2 \times E^2$  decomposition.

3. For covariantly constant right handed neutrinos the dynamics would be essentially that defined by a topological quantum field theory and this kind of almost trivial dynamics is indeed associated with small  $N = 4$  SCA.

#### 1. Why $N = 4$ super-conformal symmetry would be so nice?

$N = 2$  super-conformal invariance has been claimed to imply the vanishing of all amplitudes with more than 3 external legs for closed critical  $N = 2$  strings having  $c = 6, k = 1$  which is proposed to correspond to  $n \rightarrow \infty$  limit [?, ?]. Only the partition function and  $2 \leq N \leq 3$  scattering amplitudes would be non-vanishing. The argument of [?] relies on the imbedding of  $N = 2$  super-conformal field theory to  $N = 4$  topological string theory whereas in [?] the Ward identities for additional unbroken symmetries associated with the chiral ring accompanying  $N = 2$  super-symmetry [?] are utilized. In fact,  $N = 4$  topological string theory allows also imbeddings of  $N = 1$  super strings [?].

The properties of  $c = 6$  critical theory allowing only integral valued  $U(1)$  charges and fermion numbers would conform nicely with what we know about the perturbative electro-weak physics of leptons and gauge bosons.  $c = 1, k = 1$  sector with  $N = 2$  super-conformal symmetry would involve genuinely stringy physics since all  $N$ -point functions would be non-vanishing and the earlier hypothesis that strong interactions can be identified as electro-weak interactions which have become strong inspired by HO-H duality [K72] could find a concrete realization.

In  $c = 6$  phase  $N = 2$ -vertices the loop corrections coming from the presence of higher lepton genera in amplitude could be interpreted as topological mixing forced by unitarity implying in turn leptonic CKM mixing for leptons. The non-triviality of 3-point amplitudes would in turn be enough to have a stringy description of particle number changing reactions, such as single photon brehmstrahlung. The amplitude for the emission of more than one brehmstrahlung photons from a given lepton would vanish. Obviously the connection with quantum field theory picture would be extremely tight and imbeddability to a topological  $N = 4$  quantum field theory could make the theory to a high degree exactly solvable.

#### 2. Objections

There are also several reasons for why one must take the idea about the usefulness of  $c = 6$  super-conformal strings from the point of view of TGD with an extreme caution.



1. Stringy diagrams have quite different interpretation in TGD framework. The target space for these theories has dimension four and metric signature (2,2) or (0,4) and the vanishing theorems hold only for (2, 2) signature. In lepton sector one might regard the covariantly constant complex right-handed neutrino spinors as generators of  $N = 2$  real super-symmetries but in quark sector there are no super-symmetries.
2. The spectrum looks unrealistic: all degrees of freedom are eliminated by symmetries except single massless scalar field so that one can wonder what is achieved by introducing the extremely heavy computational machinery of string theories. This argument relies on the assumption that time-like modes correspond to negative norm so that the target space reduces effectively to a 2-dimensional Euclidian sub-space  $E^2$  so that only the vibrations in directions orthogonal to the string in  $E^2$  remain. The situation changes if one assigns negative conformal weights and negative energies to the time like excitations. In the generalized coset representation used to construct physical states this is indeed assumed.
3. The central charge has only values  $c = 6k$ , where  $k$  is the central extension parameter of  $SU(2)$  algebra [?] so that it seems impossible to realize the genuinely rational values of  $c$  which should correspond to the series of Jones inclusions. One manner to circumvent the problem would be the reduction to  $N = 2$  super-conformal symmetry.
4.  $SU(2)$  Kac-Moody algebra allows to introduce only 2-component spinors naturally whereas super-quaternions allow quantum counterparts of 8-component spinors.

The  $N = 2$  super-conformal algebra automatically extends to the so called small  $N = 4$  algebra with four super-generators  $G_{\pm}$  and their conjugates [?]. In TGD framework  $G_{\pm}$  degeneracy corresponds to the two spin directions of the covariantly constant right handed neutrinos and the conjugate of  $G_{\pm}$  is obtained by charge conjugation of right handed neutrino. From these generators one can build up a right-handed  $SU(2)$  algebra.

Hence the  $SU(2)$  Kac-Moody of the small  $N = 4$  algebra corresponds to the three imaginary quaternionic units and the  $U(1)$  of  $N = 2$  algebra to ordinary imaginary unit. Energy momentum tensor  $T$  and  $SU(2)$  generators would correspond to quaternionic units.  $G_{\pm}$  to their super counterparts and their conjugates would define their "square roots".

#### What about $N = 4$ SCA with $SU(2) \times U(1)$ Kac-Moody algebra?

Rasussen [?] has discovered an  $N = 4$  super-conformal algebra containing besides Virasoro generators and 4 Super-Virasoro generators  $SU(2) \times U(1)$  Kac-Moody algebra and two spin 1/2 fermions and a scalar.

The first identification of  $SU(2) \times U(1)$  is as electro-weak algebra for a given spin state. Second and more natural identification is as the algebra defined by rotation group and electromagnetic or Kähler charge acting on given charge state of fermion and naturally resulting in electro-weak symmetry breaking. Scalar might relate to Higgs field which is  $M^4$  scalar but  $CP_2$  vector.

There are actually two versions about Rasmussen's article [?]: in the first version the author talks about  $SU(2) \times U(1)$  Kac-Moody algebra and in the second one about  $SL(2) \times U(1)$  Kac-Moody algebra.

These variants could correspond in TGD framework to two different inclusions of hyper-finite factors of type  $II_1$ .

1. The first inclusion could be defined by  $G = SL(2, R) \subset SO(3, 1)$  acting on  $M^4$  part of H-spinors (or alternatively, as Lorentz group inducing motions in the plane  $E^2$  orthogonal to a light-like ray from the origin of light-cone  $M^4_+$ ). Physically the inclusion would mean that Lorentz degrees of freedom are frozen in the physical measurement. This leaves electro-weak group  $SU(2)_L \times U(1)$  as the group acting on H-spinors.
2. The second inclusion would be defined by the electro-weak group  $SU(2)_L$  so that Kac-Moody algebra  $SL(2, R) \times U(1)$  remains dynamical.

### 4.6.3 How large $N = 4$ SCA could emerge in quantum TGD?

The discovery of the formulation of TGD as a  $N = 4$  almost topological super-conformal QFT with light-like partonic 3-surfaces identified as basic dynamical objects increased considerably the understanding of super-conformal symmetries and their breaking in TGD framework.  $N = 4$  super-conformal algebra corresponds to the maximal algebra with  $SU(2) \times U(2)$  Kac-Moody algebra as inherent fermionic Kac-Moody algebra.

Concerning the interpretation the first guess would be that  $SU(2)_+$  and  $SU(2)_-$  correspond to vectorial spinor rotations in  $M^4$  and  $CP_2$  and  $U(1)$  to Kähler charge or electromagnetic charge. For given imbedding space chirality (lepton/quark) and  $M^4$  chirality  $SU(2)$  groups are completely fixed.

#### Identification of super generators

Consider first the fermionic generators of the super Kac-Moody algebra.

1. Assume that the modified Dirac operator decomposition  $D = D(Y^2) + D(X^2) = D(Y^1) + D(X^1) + D(X^2)$  reflecting the dual slicings of space-time surfaces to string world sheets  $Y^2$  and partonic 2-surfaces  $X^2$ .
2.  $Y^1$  represents light-like direction and also string connecting braid strands at same component of  $X_l^3$  or at two different components of  $X_l^3$ . Modified Dirac equation implies that the charges

$$\int_{X_l^3} \bar{\Psi}_{\lambda_k, n} \hat{\Gamma}^v \Psi \quad (4.6.5)$$

define conserved super charges in time direction associated with  $Y^1$  and carrying quark or lepton number. Here  $\Psi_{\lambda_k, n}$  corresponds to  $n$ :th conformal excitation of  $\Psi_{\lambda_k}$  and  $\lambda_k$  is a generalized eigenvalue of  $D(X^2)$ , whose modulus squared has interpretation as ground state conformal weight. In the case of ordinary Dirac equation essentially fermionic oscillator operators would be in question.

3. The zero modes of  $D(X^2)$  define a sub-algebra which represents super gauge symmetries. In particular, covariantly constant right handed neutrinos define this kind of super gauge super-symmetries.  $N = 2$  super-conformal symmetry would correspond in TGD framework to covariantly constant complex right handed neutrino spinors with two spin directions forming a right handed doublet and would be exact and act only in the leptonic sector relating configuration space Hamiltonians and super-Hamiltonians. This algebra extends to the so called small  $N = 4$  algebra if one introduces the conjugates of the right handed neutrino spinors. This symmetry is exact if only leptonic chirality is present in theory or if free quarks carry leptonic charges.

A physically attractive realization of the braids - and more generally- of slicings of space-time surface by 3-surfaces and string world sheets, is discussed in [?] by starting from the observation that TGD defines an almost topological QFT of braids, braid cobordisms, and 2-knots. The boundaries of the string world sheets at the space-like 3-surfaces at boundaries of  $CD$ s and wormhole throats would define space-like and time-like braids uniquely.

The idea relies on a rather direct translation of the notions of singular surfaces and surface operators used in gauge theory approach to knots [?] to TGD framework. It leads to the identification of slicing by three-surfaces as that induced by the inverse images of  $r = \text{constant}$  surfaces of  $CP_2$ , where  $r$  is  $U(2)$  invariant radial coordinate of  $CP_2$  playing the role of Higgs field vacuum expectation value in gauge theories.  $r = \infty$  surfaces correspond to geodesic spheres and define analogs of fractionally magnetically charged Dirac strings identifiable as preferred string world sheets. The union of these sheets labelled by subgroups  $U(2) \subset SU(3)$  would define the slicing of space-time surface by string world sheets. The choice of  $U(2)$  relates directly to the choice of quantization axes for color quantum numbers characterizing  $CD$  and would have the choice of braids and string world sheets as a space-time correlate.

### Identification of Kac-Moody generators

Consider next the generators of inherent Kac-Moody algebras for  $SU(2) \times SU(L) \times U(1)$  and freely chosen group  $G$ .

1. Generators of Kac-Moody algebra associated with isometries correspond Noether currents associated with the infinitesimal action of Kac-Moody algebra to the induced spinor fields. Local  $SO(3) \times SU(3)$  algebra is in question and excitations should have dependence on the coordinate  $u$  in direction of  $Y^1$ . The most natural guess is that this algebra corresponds to the Kac-Moody algebra for group  $G$ .
2. The natural candidate for the inherent Kac-Moody algebra is the holonomy algebra associated with  $S^2 \times CP_2$ . This algebra should correspond to a broken symmetry. The generalized eigen modes of  $D(X^2)$  labeled by  $\lambda_k$  should form the representation space in this case. If Kac-Moody symmetry were not broken these representations would correspond a degeneracy associated with given value of  $\lambda_k$ . Electro-weak symmetry breaking is however present and coded already into the geometry of  $CP_2$ . Also  $SO(3)$  symmetry is broken due to the presence of classical electro-weak magnetic fields. The broken symmetries could be formulated in terms of initial values of generalized eigen modes at  $X^2$  defining either end of  $X_i^3$ . One can rotate these initial values by spinor rotations. Symmetry breaking would mean that the modes obtained by a rotation by angle  $\phi = \pi$  from a mode with fixed eigenvalue  $\lambda_k$  have different eigenvalues. Four states would be obtained for a given imbedding space chirality (quark or lepton). One expects that an analog of cyclotron spectrum with cutoff results with each cyclotron state split to four states with different eigenvalues  $\lambda_k$ . Kac-Moody generators could be expressed as matrices acting in the space spanned by the eigen modes.

### Consistency with p-adic mass calculations

The consistency with p-adic mass calculations provides a strong guide line in attempts to interpret  $N = 4$  SCA. The basis ideas of p-adic mass calculations are following.

1. Fermionic partons move in color partial waves in their cm degrees of freedom. This gives to conformal weight a vacuum contribution equal to the  $CP_2$  contribution to mass squared. The contribution depends on electro-weak isospin and equals  $h_c(U) = 2$  and  $h_c(D) = 3$  for quarks and one has  $h_c(\nu) = 1$  and  $h_c(L) = 2$ .
2. The ground state can correspond also to non-negative value of  $L_0$  for SKMV algebra which gives rise to a thermal degeneracy of massless states. p-Adic mass calculations require  $(h_{gr}(D), h_{gr}(U)) = (0, -1)$  and  $(h_{gr}(L), h_{gr}(\nu)) = (-1, -2)$  so that the super-symplectic operator  $O_c$  screening the anomalous color charge has conformal weight  $h_c = -3$  for all fermions.

The simplest interpretation is that the free parameter  $h$  appearing in the representations of the SCA corresponds to the conformal weight due to the color partial wave so that the correlation with electromagnetic charge would indeed emerge but from the correlation of color partial waves and electro-weak quantum numbers.

The requirement that ground states are null states with respect to the SCV associated with the radial light-like coordinate of  $\delta M_{\pm}^4$  gives an additional consistency condition and  $h_c = -3$  should satisfy this condition. p-Adic mass calculations do not pose non-trivial conditions on  $h$  for option 1) if one makes the identification  $u = Q_{em}$  since one has  $h_{short} < 1$  for all values of  $k_+ + k_-$ . Therefore both options 1) and 2) can be considered.

### About symmetry breaking for large $N = 4$ SCA

Partonic formulation predicts that large  $N = 4$  SCA is a broken symmetry, and the first guess is that breaking occurs via several steps. First a "small"  $N = 4$  SCA with Kac-Moody group  $SU(2)_+ \times U(1)$ , where  $SU(2)_+$  corresponds to ordinary rotations on spinor with fixed helicity, would result in electro-weak symmetry breaking. The next step break spin symmetry would lead to  $N = 2$  SCA and the final step to  $N = 0$  SCA. Several symmetry breaking scenarios are possible.

1. The interpretation of  $SU(2)_+$  in terms of right- or left- handed spin rotations and  $U(1)$  as electromagnetic gauge group conforms with the general vision about electro-weak symmetry breaking in non-stringy phase. The interpretation certainly makes sense for covariantly constant right handed neutrinos for which spin direction is free. For left handed charged electro-weak bosons the action of right-handed spinor rotations is trivial so that the interpretation would make sense also now.
2. The next step in the symmetry breaking sequence would be  $N = 2$  SCA with electromagnetic Kac-Moody algebra as inherent Kac-Moody algebra  $U(1)$ .

#### 4.6.4 Relationship to super string models, M theory and WZW model

In hope of achieving more precise understanding one can try to understand the relationship of  $N = 4$  super conformal symmetry as it might appear in TGD to super strings, M theory and WZW model.

##### Relationship to super-strings and M-theory

The (4,4) signature characterizing  $N = 4$  SCA topological field theory is not a problem since in TGD framework the target space becomes a fictive concept defined by the Cartan algebra. Both  $M^4 \times CP_2$  decomposition of the imbedding space and space-time dimension are crucial for the 2+2+2+2 structure of the Cartan algebra, which together with the notions of the configuration space and generalized coset representation formed from super Kac-Moody and super-symplectic algebras guarantees  $N = 4$  super-conformal invariance.

Including the 2 gauge degrees of freedom associated with  $M^2$  factor of  $M^4 = M^2 \times E^2$  the critical dimension becomes  $D = 10$  and including the radial degree of light-cone boundary the critical dimension becomes  $D = 11$  of M-theory. Hence the fictive target space associated with the vertex operator construction corresponds to a flat background of super-string theory and flat background of M-theory with one light-like direction. From TGD point view the difficulties of these approaches are due to the un-necessary assumption that the fictive target space defined by the Cartan algebra corresponds to the physical imbedding space. The flatness of the fictive target space forces to introduce the notion of spontaneous compactification and dynamical imbedding space and this in turn leads to the notion of landscape.

##### Consistency with critical dimension of super-string models and M-theory

Mass squared is identified as the conformal weight of the positive energy component of the state rather than as a contribution to the conformal weight canceling the total conformal weight. Also the Lorentz invariance of the p-adic thermodynamics requires this. As a consequence, the pseudo 4-momentum  $p$  assignable to  $M^4$  super Kac-Moody algebra could be always light-like or even tachyonic.

Super-symplectic algebra would generate the negative conformal weight of the ground state required by the p-adic mass calculations and super-Kac Moody algebra would generate the non-negative net conformal weight identified as mass squared. In this interpretation SKM and SC degrees of freedom are independent and correspond to opposite signs for conformal weights.

The construction is consistent with p-adic mass calculations [K39, ?] and the critical dimension of super-string models.

1. Five Super Virasoro sectors are predicted as required by the p-adic mass calculations (the predicted mass spectrum depends only on the number of tensor factors). Super-symplectic algebra gives  $Can(CP_2)$  and  $Can(S^2)$ . In SKM sector one has  $SU(2)_L$ ,  $U(1)$ , local  $SU(3)$ ,  $SO(2)$  and  $E^2$  so that 5 sectors indeed result.
2. The Cartan algebras involved of SC is 2-dimensional and that of SKM is 7-dimensional so that 10-dimensional Cartan algebra results. This means that vertex operator construction implies generation of 10-dimensional target space which in super-string framework would be identified as imbedding space. Note however that these dimensions have Euclidian signature unlike in super-string models. SKM algebra allows also the option  $SO(3) \times E(3)$  in  $M^4$  degrees of freedom: this would mean that SKM Cartan algebra is 10-dimensional and the whole algebra 11-dimensional.

### $N = 4$ super-conformal symmetry and WZW models

One can question the naive idea that the basic structure  $G_{int} = SU(2) \times U(2)$  structure of  $N = 4$  SCA generalizes as such to the recent framework.

1.  $N = 4$  SCA is originally associated with Majorana spinors.  $N = 4$  algebra can be transformed from a real form to complex form with 2 complex fermions and their conjugates corresponding to complex  $H$ -spinors of definite chirality having spin and weak isospin. At least at formal level the complexification of  $N = 4$  SCA algebra seems to make sense and might be interpreted as a direct sum of two  $N = 4$  SCAs and complexified quaternions. Central charge would remain  $c = 6k_+k_-(k_+ + k_-)$  if naive complexification works. The fact that Kac-Moody algebra of spinor rotations is  $G_{int} = SO(4) \times SO(4) \times U(1)$  is naturally assignable naturally to spinors of  $H$  suggests that it represents a natural generalization of  $SO(4) \times U(1)$  algebra to inherent Kac-Moody algebra.
2. One might wonder whether the complex form of  $N = 4$  algebra could result from  $N = 8$  SCA by posing the associativity condition.
3. The article of Gunaydin [?] about the representations of  $N = 4$  super-conformal algebras realized in terms of Goddard-Kent-Olive construction and using gauged Wess-Zumino-Witten models forces however to question the straightforward translation of results about  $N = 4$  SCA to TGD framework and it must be admitted that the situation is something confusing. Of course, there is no deep reason to believe that WZW models are appropriate in TGD framework.
  - (a) Gauged WZW models are constructed using super-space formalism which is not natural in TGD framework. The coset space  $CP_2 \times U(2)$  where  $U(2)$ , could be identified as sub-algebra of color algebra or possibly as electro-weak algebra provides one such realization. Also the complexification of the  $N = 4$  algebra is something new.
  - (b) The representation involves 5-grading by the values of color isospin for  $SU(3)$  and makes sense as a coset space realization for  $G/H \times U(1)$  if  $H$  is chosen in such a manner that  $G/H \times SU(2)$  is quaternionic space. For  $SU(3)$  one has  $H = U(1)$  identifiable in terms of color hyper charge  $CP_2$  is indeed quaternionic space. For  $SU(2)$  5-grading degenerates since spin 1/2 Lie-algebra generators are absent and  $H$  is trivial group. In  $M^4$  degrees of gauged WZW model would be trivial.
  - (c)  $N = 4$  SCA results as an extension of  $N = 2$  SCA using so called Freudenthal triple system.  $N = 2$  SCA has realization in terms of  $G/H \times U(1)$  gauged WZW theory whereas the extension to  $N = 4$  SCA gives  $G \times U(1)/H$  gauged WZW model: note that  $SU(3) \times U(1)/H$  does not have an obvious interpretation in TGD framework. The Kac-Moody central extension parameters satisfy the constraint  $k_+ = k + 1$  and  $k_- = \hat{g} - 1$ , where  $k$  is the central extension parameter for  $G$ . For  $G = SU(3)$  one obtains  $k_- = 1$  and  $c = 6(k + 1)/(k + 2)$ .  $H = U(1)$  corresponding to color hyper-charge and  $U(1)$  for  $N = 2$  algebra corresponds to color isospin. The group  $U(1)$  appearing in  $SU(3) \times U(1)$  might be interpreted in terms of fermion number or Kähler charge.
  - (d) What looks somewhat puzzling is that the generators of second  $SU(2)$  algebra carry fermion number  $F = 4I_3$ . Note however that the sigma matrices of configuration space with fermion number  $\pm 2$  are non-vanishing since corresponding gamma matrices anti-commute. Second strange feature is that fermionic generators correspond to 3+3 super-coordinates of the flag-manifold  $SU(3)/U(1) \times U(1)$  plus 2 fermions and their conjugates. Perhaps the coset realization in  $CP_2$  degrees of freedom is not appropriate in TGD framework and that one should work directly with the realization based on second quantized induced spinor fields.

#### 4.6.5 The interpretation of the critical dimension $D = 4$ and the objection related to the signature of the space-time metric

The first task is to show that  $D = 4$  ( $D = 8$ ) as critical dimension of target space for  $N = 2$  ( $N = 4$ ) super-conformal symmetry makes sense in TGD framework and that the signature (2,2) ((4,4) of the metric of the target space is not a fatal flaw. The lifting of TGD to twistor space seems the most promising manner to bring in (2,2) signature. One must of course remember that super-conformal

symmetry in TGD sense differs from that in the standard sense so that one must be very cautious with comparisons at this level.

### Space-time as a target space for partonic string world sheets?

Since partonic 2-surfaces are sub-manifolds of 4-D space-time surface, it would be natural to interpret space-time surface as the target space for  $N = 2$  super-conformal string theory so that space-time dimension would find a natural explanation. Different Bohr orbit like solutions of the classical field equations could be the TGD counterpart for the dynamic target space metric of M-theory. Since partonic two-surfaces belong to 3-surface  $X_V^3$ , the correlations caused by the vacuum functional would imply non-trivial scattering amplitudes with  $CP_2$  type extremals as pieces of  $X_V^3$  providing the correlate for virtual particles. Hence the theory could be physically realistic in TGD framework and would conform with perturbative character for the interactions of leptons.  $N = 2$  super-conformal theory would of course not describe everything. This algebra seems to be still too small and the question remains how the functional integral over the configuration space degrees of freedom is carried out. It will be found that  $N = 4$  super-conformal algebra results neatly when super Kac-Moody and super-symplectic degrees of freedom are combined.

### The interpretation of the critical signature

The basic problem with this interpretation is that the signature of the induced metric cannot be (2,2) which is essential for obtaining the cancelation for  $N = 2$  SCA imbedded to  $N = 4$  SCA with critical dimension  $D = 8$  and signature (4,4). When super-generators carry fermion number and do not reduce to ordinary gamma matrices for vanishing conformal weights, there is no need to pose the condition of the metric signature. The (4,4) signature of the target space metric is not so serious limitation as it looks if one is ready to consider the target space appearing in the calculation of N-point functions as a fictive notion.

The resolution of the problems relies on two observations.

1. The super Kac-Moody and super-symplectic Cartan algebras have dimension  $D = 2$  in both  $M^4$  and  $CP_2$  degrees of freedom giving total effective dimension  $D = 8$ .
2. The generalized coset construction to be discussed in the sequel allows to assign opposite signatures of metric to super Kac-Moody Cartan algebra and corresponding super-symplectic Cartan algebra so that the desired signature (4,4) results. Altogether one has 8-D effective target space with signature (4,4) characterizing  $N = 4$  super-conformal topological strings. Hence the number of physical degrees of freedom is  $D_{phys} = 8$  as in super-string theory. Including the non-physical  $M^2$  degrees of freedom, one has critical dimension  $D = 10$ . If also the radial degree of freedom associated with  $\delta M_{\pm}^4$  is taken into account, one obtains  $D = 11$  as in M-theory.

### Small $N = 4$ SCA as sub-algebra of $N = 8$ SCA in TGD framework?

A possible interpretation of the small  $N = 4$  super-conformal algebra would be quaternionic sub-SCA of the non-associative octonionic SCA. The  $N = 4$  algebra associated with a fixed fermionic chirality would represent the fermionic counterpart for the restriction to the hyper-quaternionic submanifold of  $HO$  and  $N = 2$  algebra in the further restriction to commutative sub-manifold of  $HO$  so that this algebra would naturally appear at the parton level. Super-affine version of the quaternion algebra can be constructed straightforwardly as a special case of corresponding octonionic algebra [?]. The construction implies 4 fermion spin doublets corresponding and unit quaternion naturally corresponds to right handed neutrino spin doublet. The interpretation is as leptonic spinor fields appearing in Sugawara representation of Super Virasoro algebra.

A possible octonionic generalization of Super Virasoro algebra would involve 4 doublets  $G_{\pm}^i$ ,  $i = 1, \dots, 4$  of super-generators and their conjugates having interpretation as  $SO(8)$  spinor and its conjugate.  $G_{\pm}^i$  and their conjugates  $\overline{G}_{\pm}^i$  would anti-commute to  $SO(8)$  vector octet having an interpretation as a super-affine algebra defined by the octonionic units: this would conform nicely with  $SO(8)$  triality.

One could say that the energy momentum tensor  $T$  extends to an octonionic energy momentum tensor  $T$  as real component and affine generators as imaginary components: the real part would have

conformal weight  $h = 2$  and imaginary parts conformal weight  $h = 1$  in the proposed constructions reflecting the special role of real numbers. The ordinary gamma matrices appearing in the expression of  $G$  in Sugawara construction should be represented by units of complexified octonions to achieve non-associativity. This construction would differ from that of [?] in that  $G$  fields would define an  $SO(8)$  octet in the proposed construction: HO-H duality would however suggest that these constructions are equivalent.

One can consider two possible interpretations for  $G_{\pm}^{(i)}$  and corresponding analogs of super Kac-Moody generators in TGD framework.

1. Leptonic right handed neutrino spinors correspond to  $G_{\pm}^{(i)}$  generating quaternionic units and quark like left-handed neutrino spinors with leptonic charges to the remaining non-associative octonionic units. The interpretation in terms of so called mirror symmetry would be natural. What is clear the direct sum of  $N = 4$  SCAs corresponding to the Kac-Moody group  $SU(2) \times SU(2)$  would be exact symmetry if free quarks and leptons carry integer charges. One might however hope of getting also  $N = 8$  super-conformal algebra. The problem with this interpretation is that  $SO(8)$  transformations would in general mix states with different fermion numbers. The only way out would be the allowance of mixtures of right-handed neutrinos of both chiralities and also of their conjugates which looks an ugly option.

In any case, the well-definedness of the fermion number would require the restriction to  $N = 4$  algebra. Obviously this restriction would be a super-symmetric version for the restriction to 4-D quaternionic- or co-quaternionic sub-manifold of  $H$ .

2. One can ask whether  $G_{\pm}^{(i)}$  and their conjugates could be interpreted as components of leptonic H-spinor field. This would give 4 doublets plus their conjugates and mean  $N = 16$  super-symmetry by generalizing the interpretation of  $N = 4$  super-symmetry. In this case fermion number conservation would not forbid the realization of  $SO(8)$  rotations. Super-conformal variant of complexified octonionic algebra obtained by adding a commuting imaginary unit would result. This option cannot be excluded since in TGD framework complexified octonions and quaternions play a key role. The fact that only right handed neutrinos generate associative super-symmetries would mean that the remaining components  $G_{\pm}^{(i)}$  and their conjugates could be used to construct physical states.  $N = 8$  super-symmetry would thus break down to small  $N = 4$  symmetry for purely number theoretic reasons and the geometry of  $CP_2$  would reflect this breaking.

The objection is that the remaining fermion doublets do not allow covariantly constant modes at the level of imbedding space. They could however allow these modes as induced H-spinors in some special cases which is however not enough and this option can be considered only if one accepts breaking of the super-conformal symmetry from beginning. The conclusion is that the  $N = 8$  or even  $N = 16$  algebra might appear as a spectrum generating algebra allowing elegant coding of the primary fermionic fields of the theory.

#### 4.6.6 How could exotic Kac-Moody algebras emerge from Jones inclusions?

Also other Kac-Moody algebras than those associated with the basic symmetries of quantum TGD could emerge from Jones inclusions. The interpretation would be the TGD is able to mimic various conformal field theories. The discussion is restricted to Jones inclusions defined by discrete groups acting in  $CP_2$  degrees of freedom in TGD framework but the generalization to the case of  $M^4$  degrees of freedom is straightforward.

##### $\mathcal{M} : \mathcal{N} = \beta < 4$ case

The first situation corresponds to  $\mathcal{M} : \mathcal{N} = \beta < 4$  for which a finite subgroup  $G \subset SU(2)_L$  defines Jones inclusion  $\mathcal{N}^G \subset \mathcal{M}^G$ , with  $G$  commuting with the Clifford algebra elements creating physical states.  $\mathcal{N}$  corresponds to a subalgebra of the entire infinite-dimensional Clifford algebra  $Cl$  for which one 8-D Clifford algebra factor identifiable as Clifford algebra of the imbedding space is replaced with Clifford algebra of  $M^4$ .

Each  $M^4$  point corresponds to  $G$  orbit in  $CP_2$  and the order of maximal cyclic subgroup of  $G$  defines the integer  $n$  defining the quantum phase  $q = \exp(i\pi/n)$ . In this case the points in the

covering give rise to a representation of  $G$  defining multiplets for Kac-Moody group  $\hat{G}$  assignable to  $G$  via the ADE diagram characterizing  $G$  using McKay correspondence. Partonic boundary component defines the Riemann surface in which the conformal field theory with Kac Moody symmetry is defined. The formula  $n = k + h_{\hat{G}}$  would determine the value of Kac-Moody central extension parameter  $k$ . The singletness of fermionic oscillator operators with respect to  $G$  would be compensated by the emergence of representations of  $G$  realized in the covering of  $M^4$ .

$\mathcal{M} : \mathcal{N} = \beta = 4$  case

Second situation corresponds to  $\beta = 4$ . In this case the inclusions are classified by extended ADE diagrams assignable to Kac Moody algebras. The interpretation  $n = k + h_G$  assigning the quantum phase to  $SU(2)$  Kac Moody algebra corresponds to the Jones inclusion  $\mathcal{N}^{\hat{G}} \subset \mathcal{M}^{\hat{G}}$  of configuration space spinors for  $\hat{G} = SU(2)_L$  with index  $\mathcal{M} : \mathcal{N} = 4$  and trivial quantum phase  $q = 1$ . The Clifford algebra elements in question would be products of fermionic oscillator operators having vanishing  $SU(2)_L$  quantum numbers but arbitrary  $U(1)_R$  quantum numbers if the identification  $\hat{G} = SU(2)_L$  is correct. Thus only right handed fermions carrying homological magnetic charge would be allowed and obviously these fermions must behave like massless particles so that  $\beta < 4$  could be interpreted in terms of massivation. The ends of cosmic strings  $X^2 \times S^2 \subset M^4 \times CP_2$  would represent an example of this phase having only Abelian electro-weak interactions.

According to the proposal of [K82] the finite subgroup  $G \subset SU(2)$  defining the quantum phase emerges from the effective decomposition of the geodesic sphere  $S^2 \subset CP_2$  to a lattice having  $S^2/G$  as the unit cell. The discrete wave functions in the lattice would give rise to  $SU(2)_L \supset G$ -multiplets defining the Kac Moody representations and  $S^2/G$  would represent the 2-dimensional Riemann surface in which the conformal theory in question would be defined. Quantum phases would correspond to the holonomy of  $S^2/G$ . Therefore the singletness in fermionic degrees of freedom would be compensated by the emergence of  $G$ -multiplets in lattice degrees of freedom.

#### 4.6.7 Are both quark and lepton like chiralities needed/possible?

Before the formulation of quantum TGD based on the identification of light-like 3-surfaces as a representation of parton orbits emerged, one had to consider two different physical realizations of  $N = 4$  super-conformal symmetry. The original option for which leptons and quarks correspond to different H-chiralities of the induced spinor field is consistent with the partonic picture and definitely favored so that this subsection can be regarded as an interesting side track.

On the other hand, only lepton like chiralities are needed if one can accept a possible instability of proton. This option is mathematically the minimal but it is not at all clear whether the  $SU(3)$  associated with  $A_2$  characterizing Jones inclusion can correspond to color  $SU(3)$ . One can go further and ask whether it is even possible to have both chiralities.

#### Option I: $N = 4$ SCA and fractionally charged quarks

Quarks generate super-affinization of quaternions, which involves in no manner the Kähler charge of quarks but for fractional quark charges only SCA in the leptonic sector is possible since covariant constancy fails. At the fundamental level one the spectrum generating algebra for quarks would thus emerge and they could appear as primary fields of  $N = 4$  conformal field theory. Configuration space gamma matrices could be uniquely constructed in terms of the leptonic oscillator operators since they could correspond to super-generators of super-Kac Moody algebra. Furthermore, if the solutions of the modified Dirac equation generate super-conformal symmetries, it might be possible to have super-conformal symmetry acting also in the quark sector.

A possible manner to understand quarks is as a phase with  $N = 2$  super-conformal symmetry with  $U(1)$  Kac-Moody algebra. Using just the requirement that the charges in the  $k = 1, c = 1$  phase for  $N = 2$  super-conformal symmetry are proportional to factor  $1/3$ , one can conclude that this phase can contain ordinary quarks and fractionally charged leptons whose charge results from the phase factors depending on the sheet of the 3-fold covering of  $CP_2$ . Also phases with  $n > 3$  are possible and require fractionization of both quark and lepton charges. For quarks the condition  $n \bmod 3 = 0$  must be satisfied in this case.



**Option II:  $N = 4$  SCA and quarks as fractionally charged leptons**

For the simplest option realizing  $N = 4$  SCA only leptons are fundamental particles and quarks would be leptons in the anyonic  $k = 1, c = 1, n = 3$  phase of the theory. This option would resolve elegantly the problem whether one should construct configuration space gamma matrices using leptonic or quark like gamma matrices. Fermion number fractionization might in principle allow the decay of proton to positron plus pion as in GUTs. This decay might be however excluded for purely mathematical reasons. Indeed, the worlds corresponding to different value of  $q = \exp(i\pi/n)$  could communicate only via exchanges of bosons having a vanishing fermion number.

In the interactions between leptons and quarks the gauge bosons would penetrate to the space-time sheets corresponding to the hadrons. In  $k = 1$  phase weak interactions would become strong since arbitrarily high parton vertices would become possible and strong interactions could be simply electro-weak interactions which have become strong in the anyonic phases as HO-H duality strongly suggests [K72]. By the same duality strong interactions would have dual descriptions as non-perturbative electro-weak interactions and as color interactions.

There are objections against this picture.

1. p-Adic mass calculations rely strongly on the fact that free quarks have fractional charges and move in  $CP_2$  partial waves and it would be pity to lose the nice results of these calculations.
2. This option requires that the  $SU(3)$  associated with  $A_2$  characterizing  $n = 3$  Jones inclusion produces states equivalent with triality 1 partial waves for quarks in order to reproduce the results of p-adic mass calculations. This does not seem to be the case although one can understand how effective triality 1 states results by considering 3-fold coverings of  $CP_2$  points by  $M^4$  points defined by the space-time surfaces in question. The essential point is that  $2\pi$  rotation in  $CP_2$  phase angle leads to a different  $M^4$  point than original and  $6\pi$  rotation brings back to the original point. This might not be however enough.

**Option III: Integer charged leptons and quarks**

For the third option  $N = 4$  superconformal symmetry can be realized in both lepton and quark sector but by the previous arguments  $N = 8$  SCA is not possible. Both imbedding space chiralities would possess leptonic quantum numbers and would be allowed as fundamental fermions. At the level of configuration space the choice of either chirality to realize the configuration space gamma matrices would correspond to the selection of quark or lepton like chirality. This presumably leads to problems with continuity unless the two chiralities correspond to completely disjoint parts of the configuration space.

Finding an explanation for the experimental absence of the free integer charged quarks is the basic challenge met by the advocate of integer charged free quarks. A possible explanation could rely on the fact that also gauge bosons would be doubled. There are two options.

1. The two kinds of gauge bosons couple to only single H-chirality. One can indeed argue that if one allows at given space-time sheet only quark or lepton like chirality then it is not possible to have quantum superpositions of fermion-antifermion pairs of opposite chiralities at a given space-time sheet so that bosons would couple to either quark or lepton like chirality. This would mean that leptons and free quarks would have no electro-weak interactions. Even gravitational interaction would be absent. This would however imply that ordinary hadrons should consist of fractionally charged leptons so that second chirality would not appear at all in known or experimentally testable physics.
2. An option allowing ordinary hadrons to consist of genuine quarks is that the couplings of these two bosons are vectorial and axial with respect to H-chirality (the simplest option) and left-right permutation occurs for electro-weak couplings. This would induce a breaking of the chiral symmetry at the level of  $H$  just as the ordinary weak interactions do at the level of  $M^4$  and the masses of integer charged quarks could differ from those of genuine leptons.

If H-vectorial and H-axial gauge bosons have same coupling strengths and masses, the diagrams representing exchanges of vectorial and axial gauge bosons would interfere to zero so that free leptons and quarks would not see each other at all. This should be true in  $(c = 6, n = \infty)$  phase. This could

be the case for even gravitons. On the other hand, the interactions between free quarks and hadronic quarks would be possible and would make free quarks visible so that this option seems to produce more problems than to solve them.

In ( $c = 1, k = 1, n = 3$ ) phase leptons and quarks should interact and this is achieved if the masses and couplings of H-vectorial or H-axial electro-weak bosons are different in this phase. It is far from clear whether this picture can be consistent with what is known about lepton-hadron interactions.

### Common features of the options I and II

Consider now the common features of options I and II which on basis of the previous arguments look the only realistic ones.

1. For both options only  $c = 6$  would correspond to the integer charged world and hadrons would be represented by primary fields in this phase. Hadrons would correspond to  $k = 1, c = 1$  representation for the reduced  $N = 2$  conformal symmetry. Elementary fermions inside hadrons would correspond to the lowest  $n = 3$  Jones inclusion having  $k = 1$  which indeed corresponds to  $A_2$  Dynkin diagram and thus  $SU(3)$ . Ordinary leptons and quarks (whether fractionally charged leptons or not) would thus live in different  $CP_2$ :s (recall that the generalized imbedding space has fan like structure with different  $M^4 \times CP_2$ :s meeting along  $M^4$ ). This would explain the impossibility to observe free fractionally charged quarks.

Anyonic color triplet leptons and fractionally charged quarks would live at the three branches of the covering of  $CP_2$ . The observation that leptonic spinors possess anomalous color hyper-charge identifiable as lepton number and that this charge corresponds to weak hyper-charge explains why the electromagnetic charge of lepton can be fractionized but not its weak isospin.

2. An infinite hierarchy of states with fractionally charged fermions would be predicted with charges of form  $m/n$  appearing as dark matter so that the counterparts of quarks would represent only the simplest Jones inclusion. For quarks one would have  $n = k + 2 \pmod{3} = 0$ . The invisibility of free fractionally charged fermions would be equivalent with the invisibility of dark matter with scaled up value of  $CP_2$  Planck constant in both options. For option I the phase transition transforming leptons to quarks and vice versa would require three leptons per quark in order to achieve conservation of fermion number.
3. I have already proposed the idea that antimatter is dark matter [K65] and the obvious possibility is that matter-antimatter asymmetry corresponds to the transformation of  $n$  anti-leptons to baryon like entities consisting of  $n$  fractionally charged leptons inside which they behave like dark matter. For option II anti-leptons would correspond to baryons and antimatter would be directly observable.

### Lepton-hadron interactions for various options

The interactions between leptons and quarks and their fractionally charged counterparts can be also understood. The following arguments favor option I and II over option III.

1. Quite generally, the  $CP_2$  type extremal representing virtual electroweak boson must tunnel between two  $CP_2$ :s in the fan formed by  $M^4 \times CP_2$ :s glued together along  $M^4$  and in this process transform to hadronic weak boson. This means that also strong interactions between leptons and hadrons are generated but these interactions could be seen as secondary strong interactions occurring inside hadron in any case via the decay of photon to quark pair in turn interacting strongly with other partons.

The coupling constant characterizing the tunneling must be such that correct results for electro-weak interactions between quarks and leptons are obtained in the lowest order. The notion of vector meson dominance meaning that weak bosons transform to strongly interacting mesons with same electro-weak quantum numbers conforms with this picture.

2. For option II the lowest order contributions to electro-weak interactions inside hadrons could be identified as direct lepton-quark interaction and there are no obvious problems involved.

3. For option I gauge bosons must couple to both chiralities in order to make possible the interaction between leptons and quarks. This is possible and the prediction is that gauge bosons should appear as H-vectorial and H-axial variants or their mixtures. A doubling of ordinary vector bosons is predicted. This however does not have any dramatic effects if ordinary gauge bosons correspond to H-vectorial gauge bosons and axial ones are heavy enough. Nothing new is predicted for situation in which leptons do not penetrate inside hadrons. A lepton penetrating into hadron must suffer an anyonization and becomes fractionally charged and decomposes into a triplet of leptons with fractional fermion number. This implies that lepton has strong interactions with quarks.
4. For option III the understanding of the interactions between leptons and hadrons consisting of genuine quarks becomes a highly non-trivial problem for several reasons.
  - (a) The hypothesis that only fermions of fixed chirality are possible at a given space-time sheet would exclude the possibility of non-trivial interactions between leptons and hadrons. If one gives up this assumption the doubling of electro-weak interactions gives however hopes for describing the interactions. The non-observability of free quarks in  $c = 6$  phase is guaranteed if the masses and couplings of H-vectorial and -axial bosons are identical in this phase. To have interactions in  $k = 1$  phase, these couplings and masses must be different. This would look nice at first since one could hope of explaining strong interactions in terms of this symmetry breaking.
  - (b) However, if H-vectorial and -axial couplings are different inside hadrons, the expectation is that the resulting low energy lepton-hadron electro-weak interactions are quite different from what they are known to be experimentally. The most natural guess suggested by the masslessness of gluons is that all (say) H-axial weak bosons are massless inside hadrons. However, if both H-vectorial and -axial photons are massless there would be no electromagnetic coupling between quarks and leptons and hadrons would look like em neutral particles at low energies.
  - (c) The coupling constant characterizing this tunneling should have a value making possible to reproduce the standard model picture about lepton-quark scattering. If only (say) H-vectorial ew bosons can tunnel to hadron and the amplitude  $A$  for the tunneling equals to  $A = 2$  it gives amplitude equal to  $V - V + A - A = 2V - V$  between leptons then quark-lepton scattering can be reproduced correctly. This kind of transformation is however not described by a unitary S-matrix.

### New view about strong interactions

The proposed picture suggests the identification of strong interactions as electro-weak interactions which have become strong in  $k = 1$  anyonic phase. HO-H duality leads to the same proposal [K72] .

#### 1. Strong interactions as electro-weak interactions in a non-perturbative phase?

Consider the situation in  $k = 1, c = 1$  hadronic sector at the sheets of 3-fold covering of  $M^4$  at which fractionally charged fermions reside. It is an experimental fact that their electro-weak interactions allow a perturbative description. One would however obtain all higher order stringy diagrams allowed by rational conformal field theories. This looks like a paradox but one can consider the possibility that electro-weak interactions give rise also to strong interactions.

For all options the non-vanishing of higher n-point functions in  $k = 1, c = 1$  phase would give rise to and additional non-perturbative contribution to electro-weak interactions having a natural interpretation as strong interactions. Weak isospin and hypercharge could be interpreted also as strong isospin and hyper-charge as is indeed found to be the case experimentally. Conserved vector current hypothesis and partially conserved axial current hypothesis of the old-fashioned hadron physics indeed support this kind of duality.

For option I one can consider the possibility that H-axial bosons define the dual counterparts of gluons and are massless. H-axial electro-weak interactions would give rise also to strong interactions between quarks and anyonic leptons inside hadrons. The idea that color interactions have dual description as H-axial electro-weak interactions is admittedly rather seductive.

For option III different masses and couplings of H-vectorial and H-axial bosons inside hadrons would allow to interpret strong interactions as (say) axial weak interactions. The simplest option would be that H-axial weak bosons are massless so that strong isospin and hyper-charge would correspond to their H-axial variants. The problems relating to the interaction between leptons and hadrons have been already mentioned: for instance, em interactions between leptons and quarks would vanish if they vanish in  $c = 6$  phase.

### 2. *HO-H duality and equivalence with QCD type description*

One can ask how QCD type description emerges if strong interactions are non-perturbative electro-weak interactions (option II) or H-axial counterparts of them (option I). In [K72] I have discussed a possible duality suggested by the fact that space-time surfaces can be regarded as 4-surfaces in hyper-octonionic  $H = M^8$  or in  $H = M^4 \times CP_2$ . In the first picture spinors would be octonionic spinors and correspond to two leptonic singlets and color triplet and its conjugate: there would be no trace about spin and electro-weak quantum numbers besides electro-weak hyper charge.

The absence of spin in *HO* description could provide a resolution of the spin puzzle of proton (quarks do not seem to contribute to the spin of proton). In *H* picture spinors would carry only electro-weak quantum numbers and spin besides anomalous color hypercharge. The question is whether quark like spinors in *HO* are equivalent with leptonic spinors in *H* and whether the descriptions based on (possibly) doubled electro-weak and color interactions are equivalent for many-sheeted coverings.

## 4.7 Preferred extremals and solutions of the modified Dirac equation and super-conformal symmetries

The previous considerations concerning super-conformal symmetries and space-time SUSY have been based on general arguments. The new vision about preferred extremals and modified Dirac equation [?] however leads to a detailed understanding of super-conformal symmetries at the level of field equations and is bound to modify the existing vision about super-conformal symmetries. One important discovery is that Einstein's equations follow from the vanishing of terms proportional to Kähler current in field equations for preferred extremals and Equivalence Principle at the classical level is realized automatically in all scales in contrast to the earlier belief. This obviously must have implications to the general vision about Super-Virasoro representations and one must be ready to modify the existing picture based on the assumption that quantum version of Equivalence Principle is realized in terms coset representations.

The very special role of right handed neutrino is also bound to have profound implications. A further important outcome is the identification of gauge potentials as duals of Kac-Moody currents at the boundaries of string world sheets: quantum gauge potentials are defined only where they are needed that is the curves defining the non-integrable phase factors. This gives also rise to the realization of the conjecture Yangian in terms of the Kac-Moody charges and commutators in accordance with the earlier conjecture.

### 4.7.1 Super-conformal symmetries

It is good to summarize first the basic ideas about Super-Virasoro representations. TGD allows two kinds of super-conformal symmetries.

1. The first super-conformal symmetry is associated with  $\delta M_{\pm}^4 \times CP_2$  and corresponds to symplectic symmetries of  $\delta M_{\pm}^4 \times CP_2$ . The reason for extension of conformal symmetries is metric 2-dimensionality of the light-like boundary  $\delta M_{\pm}^4$  defining upper/lower boundary of causal diamond (*CD*). This super-conformal symmetry is something new and corresponds to replacing finite-dimensional Lie-group  $G$  for Kac-Moody symmetry with infinite-dimensional symplectic group. The light-like radial coordinate of  $\delta M_{\pm}^4$  takes the role of the real part of complex coordinate  $z$  for ordinary conformal symmetry. Together with complex coordinate of  $S^2$  it defines 3-D restriction of Hamilton-Jacobi variant of 4-D super-conformal symmetries. One can continue the conformal symmetries from light-cone boundary to *CD* by forming a slicing by parallel copies of  $\delta M_{\pm}^4$ . There are two possible slicings corresponding to the choices  $\delta M_{+}^4$  and  $\delta M_{-}^4$  assignable to the

upper and lower boundaries of  $CD$ . These two choices correspond to two arrows of geometric time for the basis of zero energy states in ZEO.

2. Super-symplectic degrees of freedom determine the electroweak and color quantum numbers of elementary particles. Bosonic emergence implies that ground states assignable to partonic 2-surfaces correspond to partial waves in  $\delta M_{\pm}^4$  and one obtains color partial waves in particular. These partial waves correspond to the solutions for the Dirac equation in imbedding space and the correlation between color and electroweak quantum numbers is not quite correct. Super-Kac-Moody generators give the compensating color for massless states obtained from tachyonic ground states guaranteeing that standard correlation is obtained. Super-symplectic degrees are therefore directly visible in particle spectrum. One can say that at the pointlike limit the WCW spinors reduce to tensor products of imbedding space spinors assignable to the center of mass degrees of freedom for the partonic 2-surfaces defining wormhole throats.

I have proposed a physical interpretation of super-symplectic vibrational degrees of freedom in terms of degrees of freedom assignable to non-perturbative QCD. These degrees of freedom would be responsible for most of the baryon masses but their theoretical understanding is lacking in QCD framework.

3. The second super-conformal symmetry is assigned light-like 3-surfaces and to the isometries and holonomies of the imbedding space and is analogous to the super-Kac-Moody symmetry of string models. Kac-Moody symmetries could be assigned to the light-like deformations of light-like 3-surfaces. Isometries give tensor factor  $E^2 \times SU(3)$  and holonomies factor  $SU(2)_L \times U(1)$ . Altogether one has 5 tensor factors to super-conformal algebra. That the number is just five is essential for the success p-adic mass calculations [K45, K39].

The construction of solutions of the modified Dirac equation suggests strongly that the fermionic representation of the Super-Kac-Moody algebra can be assigned as conserved charges associated with the space-like braid strands at both the 3-D space-like ends of space-time surfaces and with the light-like (or space-like with a small deformation) associated with the light-like 3-surfaces. The extension to Yangian algebra involving higher multilinears of super-Kac Moody generators is also highly suggestive. These charges would be non-local and assignable to several wormhole contacts simultaneously. The ends of braids would correspond points of partonic 2-surfaces defining a discretization of the partonic 2-surface having interpretation in terms of finite measurement resolution.

These symmetries would correspond to electroweak and strong gauge fields and to gravitation. The duals of the currents giving rise to Kac-Moody charges would define the counterparts of gauge potentials and the conserved Kac-Moody charges would define the counterparts of non-integrable phase factors in gauge theories. The higher Yangian charges would define generalization of non-integrable phase factors. This would suggest a rather direct connection with the twistorial program for calculating the scattering amplitudes implies also by zero energy ontology.

Quantization recipes have worked in the case of super-string models and one can ask whether the application of quantization to the coefficients of powers of complex coordinates or Hamilton-Jacobi coordinates could lead to the understanding of the 4-D variants of the conformal symmetries and give detailed information about the representations of the Kac-Moody algebra too.

#### 4.7.2 What is the role of the right-handed neutrino?

A highly interesting aspect of Super-Kac-Moody symmetry is the special role of right handed neutrino.

1. Only right handed neutrino allows besides the modes restricted to 2-D surfaces also the 4D modes delocalized to the entire space-time surface. The first ones are holomorphic functions of single coordinate and the latter ones holomorphic functions of two complex/Hamilton-Jacobi coordinates. Only  $\nu_R$  has the full  $D = 4$  counterpart of the conformal symmetry and the localization to 2-surfaces has interpretation as super-conformal symmetry breaking halving the number of super-conformal generators.
2. This forces to ask for the meaning of super-partners. Are super-partners obtained by adding  $\nu_R$  neutrino localized at partonic 2-surface or delocalized to entire space-time surface or its

Euclidian or Minkowskian region accompanying particle identified as wormhole throat? Only the Euclidian option allows to assign right handed neutrino to a unique partonic 2-surface. For the Minkowskian regions the assignment is to many particle state defined by the partonic 2-surfaces associated with the 3-surface. Hence for spartners the 4-D right-handed neutrino must be associated with the 4-D Euclidian line of the generalized Feynman diagram.

3. The orthogonality of the localized and de-localized right handed neutrino modes requires that 2-D modes correspond to higher color partial waves at the level of imbedding space. If color octet is in question, the 2-D right handed neutrino as the candidate for the generator of standard SUSY would combine with the left handed neutrino to form a massive neutrino. If 2-D massive neutrino acts as a generator of super-symmetries, it is in the same role as badly broken supersymmetries generated by other 2-D modes of the induced spinor field (SUSY with rather large value of  $\mathcal{N}$ ) and one can argue that the counterpart of standard SUSY cannot correspond to this kind of super-symmetries. The right-handed neutrinos delocalized inside the lines of generalized Feynman diagrams, could generate  $\mathcal{N} = 2$  variant of the standard SUSY.

### How particle and right handed neutrino are bound together?

Ordinary SUSY means that apart from kinematical spin factors sparticles and particles behave identically with respect to standard model interactions. These spin factors would allow to distinguish between particles and sparticles. But is this the case now?

1. One can argue that 2-D particle and 4-D right-handed neutrino behave like independent entities, and because  $\nu_R$  has no standard model couplings this entire structure behaves like a particle rather than sparticle with respect to standard model interactions: the kinematical spin dependent factors would be absent.
2. The question is also about the internal structure of the sparticle. How the four-momentum is divided between the  $\nu_R$  and 2-D fermion. If  $\nu_R$  carries a negligible portion of four-momentum, the four-momentum carried by the particle part of sparticle is same as that carried by particle for given four-momentum so that the distinctions are only kinematical for the ordinary view about sparticle and trivial for the view suggested by the 4-D character of  $\nu_R$ .

Could sparticle character become manifest in the ordinary scattering of sparticle?

1. If  $\nu_R$  behaves as an independent unit not bound to the particle, it would continue in the original direction as particle scatters: sparticle would decay to particle and right-handed neutrino. If  $\nu_R$  carries a non-negligible energy the scattering could be detected via a missing energy. If not, then the decay could be detected by the interactions revealing the presence of  $\nu_R$ .  $\nu_R$  can have only gravitational interactions. What these gravitational interactions are is not however quite clear since the proposed identification of gravitational gauge potentials is as duals of Kac-Moody currents analogous to gauge potentials located at the boundaries of string world sheets. Does this mean that 4-D right-handed neutrino has no quantal gravitational interactions? Does internal consistency require  $\nu_R$  to have a vanishing gravitational and inertial masses and does this mean that this particle carries only spin?
2. The cautious conclusion would be following: if delocalized  $\nu_R$  and parton are un-correlated particle and sparticle cannot be distinguished experimentally and one might perhaps understand the failure to detect standard SUSY at LHC. Note however that the 2-D fermionic oscillator algebra defines badly broken large  $\mathcal{N}$  SUSY containing also massive (longitudinal momentum square is non-vanishing) neutrino modes as generators.

### Taking a closer look on sparticles

It is good to take a closer look at the delocalized right handed neutrino modes.

1. At imbedding space level that is in cm mass degrees of freedom they correspond to covariantly constant  $CP_2$  spinors carrying light-like momentum which for causal diamond could be discretized. For non-vanishing momentum one can speak about helicity having opposite sign for

$\nu_R$  and  $\bar{\nu}_R$ . For vanishing four-momentum the situation is delicate since only spin remains and Majorana like behavior is suggestive. Unless one has momentum continuum, this mode might be important and generate additional SUSY resembling standard  $\mathcal{N} = 1$  SUSY.

2. At space-time level the solutions of modified Dirac equation are holomorphic or anti-holomorphic.
  - (a) For non-constant holomorphic modes these characteristics correlate naturally with fermion number and helicity of  $\nu_R$ . One can assign creation/annihilation operator to these two kinds of modes and the sign of fermion number correlates with the sign of helicity.
  - (b) The covariantly constant mode is naturally assignable to the covariantly constant neutrino spinor of imbedding space. To the two helicities one can assign also oscillator operators  $\{a_{\pm}, a_{\pm}^{\dagger}\}$ . The effective Majorana property is expressed in terms of non-orthogonality of  $\nu_R$  and  $\bar{\nu}_R$  translated to the non-vanishing of the anti-commutator  $\{a_{+}^{\dagger}, a_{-}\} = \{a_{-}^{\dagger}, a_{+}\} = 1$ . The reduction of the rank of the  $4 \times 4$  matrix defined by anti-commutators to two expresses the fact that the number of degrees of freedom has halved.  $a_{+}^{\dagger} = a_{-}$  realizes the conditions and implies that one has only  $\mathcal{N} = 1$  SUSY multiplet since the state containing both  $\nu_R$  and  $\bar{\nu}_R$  is same as that containing no right handed neutrinos.
  - (c) One can wonder whether this SUSY is masked totally by the fact that sparticles with all possible conformal weights  $n$  for induced spinor field are possible and the branching ratio to  $n = 0$  channel is small. If momentum continuum is present, the zero momentum mode might be equivalent to nothing.

What can happen in spin degrees of freedom in super-symmetric interaction vertices if one accepts this interpretation? As already noticed, this depends solely on what one assumes about the correlation of the four-momenta of particle and  $\nu_R$ .

1. For SUSY generated by covariantly constant  $\nu_R$  and  $\bar{\nu}_R$  there is no neutrino four-momentum involved so that only spin matters. One cannot speak about the change of direction for  $\nu_R$ . In the scattering of sparticle the direction of particle changes and introduces different spin quantization axes.  $\nu_R$  retains its spin and in new system it is superposition of two spin projections. The presence of both helicities requires that the transformation  $\nu_R \rightarrow \bar{\nu}_R$  happens with an amplitude determined purely kinematically by spin rotation matrices. This is consistent with fermion number conservation modulo 2.  $\mathcal{N} = 1$  SUSY based on Majorana spinors is highly suggestive.
2. For SUSY generated by non-constant holomorphic and anti-holomorphic modes carrying fermion number the behavior in the scattering is different. Suppose that the sparticle does not split to particle moving in the new direction and  $\nu_R$  moving in the original direction so that also  $\nu_R$  or  $\bar{\nu}_R$  carrying some massless fraction of four-momentum changes its direction of motion. One can form the spin projections with respect to the new spin axis but must drop the projection which does not conserve fermion number. Therefore the kinematics at the vertices is different. Hence  $\mathcal{N} = 2$  SUSY with fermion number conservation is suggestive when the momentum directions of particle and  $\nu_R$  are completely correlated.
3. Since right-handed neutrino has no standard model couplings, p-adic thermodynamics for 4-D right-handed neutrino must correspond to a very low p-adic temperature  $T = 1/n$ . This implies that the excitations with non-vanishing conformal weights are effectively absent and one would have  $\mathcal{N} = 1$  SUSY effectively.

The simplest assumption is that particle and sparticle correspond to the same p-adic mass scale and have degenerate masses: it is difficult to imagine any good reason for why the p-adic mass scales should differ. This should have been observed -say in decay widths of weak bosons - unless the spartners correspond to large hbar phase and therefore to dark matter. Note that for the badly broken 2-D  $\mathcal{N}=2$  SUSY in fermionic sector this kind of almost degeneracy cannot be excluded and I have considered an explanation for the mysterious X and Y mesons in terms of this degeneracy [K43].

### Why space-time SUSY is not possible in TGD framework?

LHC suggests that one does not have  $\mathcal{N} = 1$  SUSY in standard sense. Why one cannot have standard space-time SUSY in TGD framework. Let us begin by listing all arguments popping in mind.

1. Could covariantly constant  $\nu_R$  represents a gauge degree of freedom? This is plausible since the corresponding fermion current is non-vanishing.
2. The original argument for absence of space-time SUSY years ago was indirect:  $M^4 \times CP_2$  does not allow Majorana spinors so that  $\mathcal{N} = 1$  SUSY is excluded.
3. One can however consider  $\mathcal{N} = 2$  SUSY by including both helicities possible for covariantly constant  $\nu_R$ . For  $\nu_R$  the four-momentum vanishes so that one cannot distinguish the modes assigned to the creation operator and its conjugate via complex conjugation of the spinor. Rather, one oscillator operator and its conjugate correspond to the two different helicities of right-handed neutrino with respect to the direction determined by the momentum of the particle. The spinors can be chosen to be real in this basis. This indeed gives rise to an irreducible representation of spin 1/2 SUSY algebra with right-handed neutrino creation operator acting as a ladder operator. This is however  $\mathcal{N} = 1$  algebra and right-handed neutrino in this particular basis behaves effectively like Majorana spinor. One can argue that the system is mathematically inconsistent. By choosing the spin projection axis differently the spinor basis becomes complex. In the new basis one would have  $\mathcal{N} = 2$ , which however reduces to  $\mathcal{N} = 1$  in the real basis.
4. Or could it be that fermion and sfermion do exist but cannot be related by SUSY? In standard SUSY fermions and sfermions forming irreducible representations of super Poincare algebra are combined to components of superfield very much like finite-dimensional representations of Lorentz group are combined to those of Poincare. In TGD framework  $\nu_R$  generates in space-time interior generalization of 2-D super-conformal symmetry but covariantly constant  $\nu_R$  cannot give rise to space-time SUSY.

This would be very natural since right-handed neutrinos do not have any electroweak interactions and are delocalized into the interior of the space-time surface unlike other particles localized at 2-surfaces. It is difficult to imagine how fermion and  $\nu_R$  could behave as a single coherent unit reflecting itself in the characteristic spin and momentum dependence of vertices implied by SUSY. Rather, it would seem that fermion and sfermion should behave identically with respect to electroweak interactions.

The third argument looks rather convincing and can be developed to a precise argument.

1. If sfermion is to represent elementary bosons, the products of fermionic oscillator operators with the oscillator operators assignable to the covariantly constant right handed neutrinos must define might-be bosonic oscillator operators as  $b_n = a_n a$  and  $b_n^\dagger = a_n^\dagger a^\dagger$ . One can calculate the commutator for the product of operators. If fermionic oscillator operators commute, so do the corresponding bosonic operators. The commutator  $[b_n, b_n^\dagger]$  is however proportional to occupation number for  $\nu_R$  in  $\mathcal{N} = 1$  SUSY representation and vanishes for the second state of the representation. Therefore  $\mathcal{N} = 1$  SUSY is a pure gauge symmetry.
2. One can however have both irreducible representations of SUSY: for them either fermion or sfermion has a non-vanishing norm. One would have both fermions and sfermions but they would not belong to the same SUSY multiplet, and one cannot expect SUSY symmetries of 3-particle vertices.
3. For instance,  $\gamma FF$  vertex is closely related to  $\gamma \tilde{F} \tilde{F}$  in standard SUSY. Now one expects this vertex to decompose to a product of  $\gamma F \tilde{F}$  vertex and amplitude for the creation of  $\nu_R \tilde{\nu}_R$  from vacuum so that the characteristic momentum and spin dependent factors distinguishing between the couplings of photon to scalar and fermion are absent. Both states behave like fermions. The amplitude for the creation of  $\nu_R \tilde{\nu}_R$  from vacuum is naturally equal to unity as an occupation number operator by crossing symmetry. The presence of right-handed neutrinos would be invisible if this picture is correct. Whether this invisible label can have some consequences is not quite clear: one could argue that the decay rates of weak bosons to fermion pairs are doubled unless one introduces  $1/\sqrt{2}$  factors to couplings.



Where the sfermions might make themselves visible are loops. What loops are? Consider boson line first. Boson line is replaced with a sum of two contributions corresponding to ordinary contribution with fermion and antifermion at opposite throats and second contribution with fermion and antifermion accompanied by right-handed neutrino  $\nu_R$  and its antiparticle which now has opposite helicity to  $\nu_R$ . The loop for  $\nu_R$  decomposes to four pieces since also the propagation from wormhole throat to the opposite wormhole throat must be taken into account. Each of the four propagators equals to  $a_{1/2}^\dagger a_{-1/2}^\dagger$  or its hermitian conjugate. The product of these is slashed between vacuum states and anti-commutations give imaginary unit per propagator giving  $i^4 = 1$ . The two contributions are therefore identical and the scaling  $g \rightarrow g/\sqrt{2}$  for coupling constants guarantees that sfermions do not affect the scattering amplitudes at all. The argument is identical for the internal fermion lines.

### 4.7.3 WCW geometry and super-conformal symmetries

The vision about the geometry of WCW has been roughly the following and the recent steps of progress induce to it only small modifications if any.

1. Kähler geometry is forced by the condition that hermitian conjugation allows geometrization. Kähler function is given by the Kähler action coming from space-time regions with Euclidian signature of the induced metric identifiable as lines of generalized Feynman diagrams. Minkowskian regions give imaginary contribution identifiable as the analog of Morse function and implying interference effects and stationary phase approximation. The vision about quantum TGD as almost topological QFT inspires the proposal that Kähler action reduces to 3-D terms reducing to Chern-Simons terms by the weak form of electric-magnetic duality. The recent proposal for preferred extremals is consistent with this property realizing also holography implied by general coordinate invariance. Strong form of general coordinate invariance implying effective 2-dimensionality in turn suggests that Kähler action is expressible in terms of areas of partonic 2-surfaces and string world sheets.
2. The complexified gamma matrices of WCW come as hermitian conjugate pairs and anti-commute to the Kähler metric of WCW. Also bosonic generators of symplectic transformations of  $\delta M_\pm^4 \times CP_2$  assumed to act as isometries of WCW geometry can be complexified and appear as similar pairs. The action of isometry generators co-incides with that of symplectic generators at partonic 2-surfaces and string world sheets but elsewhere inside the space-time surface it is expected to be deformed from the symplectic action. The super-conformal transformations of  $\delta M_\pm^4 \times CP_2$  acting on the light-like radial coordinate of  $\delta M_\pm^4$  act as gauge symmetries of the geometry meaning that the corresponding WCW vector fields have zero norm.
3. WCW geometry has also zero modes which by definition do not contribute to WCW metric expect possibly by the dependence of the elements of WCW metric on zero modes through a conformal factor. In particular, induced  $CP_2$  Kähler form and its analog for sphere  $r_M = constant$  of light cone boundary are symplectic invariants, and one can define an infinite number of zero modes as invariants defined by Kähler fluxes over partonic 2-surfaces and string world sheets. This requires however the slicing of  $CD$  parallel copies of  $\delta M_\pm^4$  or  $\delta M_\pm^4$ . The physical interpretation of these non-quantum fluctuating degrees of freedom is as classical variables necessary for the interpretation of quantum measurement theory. Classical variable would metaphorically correspond the position of the pointer of the measurement instrument.
4. The construction receives a strong philosophical inspiration from the geometry of loop spaces. Loop spaces allow a unique Kähler geometry with maximal isometry group identifiable as Kac-Moody group. The reason is that otherwise Riemann connection does not exist. The only problem is that curvature scalar diverges since the Riemann tensor is by constant curvature property proportional to the metric. In 3-D case one would have union of constant curvature spaces labelled by zero modes and the situation is expected to be even more restrictive. The conjecture indeed is that WCW geometry exists only for  $H = M^4 \times CP_2$ : infinite-D Kähler geometric existence and therefore physics would be unique. One can also hope that Ricci scalar is finite and therefore zero by the constant curvature property so that Einstein's equations are satisfied.

5. WCW Hamiltonians determined the isometry currents and WCW metric is given in terms of the anti-commutators of the Killing vector fields associated with symplectic isometry currents. The WCW Hamiltonians generating symplectic isometries correspond to the Hamiltonians spanning the symplectic group of  $\delta M_{\pm}^4 \times CP_2$ . One can say that the space of quantum fluctuating degrees of freedom is this symplectic group of  $\delta M_{\pm}^4 \times CP_2$  or its subgroup or coset space: this must have very deep implications for the structure of the quantum TGD.
6. Zero energy ontology brings in additional delicacies. Basic objects are now unions of partonic 2-surfaces at the ends of  $CD$ . Also string world sheets would naturally contribute. One can generalize the expressions for the isometry generators in a straightforward manner by requiring that given isometry restricts to a symplectic transformation at partonic 2-surfaces and string world sheets.
7. One could criticize the effective metric 2-dimensionality forced by general consistency arguments as something non-physical. The Hamiltonians are expressed using only the data at partonic 2-surfaces: this includes also 4-D tangent space data via the weak form of electric-magnetic duality so that one has only effective 2-dimensionality. Obviously WCW geometry must have large gauge symmetries besides zero modes. The super-conformal symmetries indeed represent gauge symmetries of this kind. Effective 2-dimensionality realizing strong form of holography in turn is induced by the strong form of general coordinate invariance. Light-like 3-surfaces at which the signature of the induced metric changes must be equivalent with the 3-D space-like ends of space-time surfaces at the light-boundaries of space-time surfaces as far as WCW geometry is considered. This requires that the data from their 2-D intersections defining partonic 2-surfaces should dictate the WCW geometry. Note however that Super-Kac-Moody charges giving information about the interiors of 3-surfaces appear in the construction of the physical states.

What is the role of the right handed neutrino in this construction?

1. In the construction of components of WCW metric as anti-commutators of super-generators only the covariantly constant right-handed neutrino appears in the super-generators analogous to super-Kac-Moody generators. All holomorphic modes of right handed neutrino characterized by two integers could in principle contribute to the WCW gamma matrices identified as fermionic super-symplectic generators anti-commuting to the metric. At the space-like ends of space-time surface the holomorphic generators would restrict to symplectic generators since the radial light-like coordinate  $r_M$  identified and complex coordinate of  $CP_2$  allowing identification as restrictions of two complex coordinates or Hamilton-Jacobi coordinates to light-like boundary.
2. The non-covariantly constant modes could also correspond to purely super-conformal gauge degrees of freedom. Originally the restriction to right-handed neutrino looked somewhat unsatisfactory but the recent view about Super-Kac-Moody symmetries makes its special role rather natural. One could say that WCW geometry possesses the maximal  $D = 4$  supersymmetry.
3. One can of course ask whether the Super-Kac-Moody generators assignable to the isometries of  $H$  and expressible as conserved charges associated with the boundaries of string world sheets could contribute to the WCW geometry via the anti-commutators. This option cannot be excluded but in this case the interpretation in terms of Hamiltonians is not obvious.

#### 4.7.4 Equivalence Principle

An important physical input has been the condition that a generalization of Equivalence Principle is obtained.

1. The proposal has been that inertial and gravitational masses can be assigned with the super-symplectic and super-Kac-Moody representations via the condition that the scaling generator  $L_0$  defined as a difference of the corresponding generators for the two representations annihilates physical states. This requires that super-Kac-Moody algebra can be regarded in some sense as a sub-algebra of super-symplectic algebra. For isometries this would be natural but in the case of holonomies the situation is problematic. The idea has been that the ordinary realization of

Equivalence Principle follows as Einstein's equations for fluctuations around vacuum extremals expressing the average energy momentum tensor for the fluctuations.

2. The emergence of Einstein's equations for preferred extremals as additional conditions [K9, K77] allowing the algebraization of the equations to analogs of minimal surface equations changes the situation completely. Is there anymore need to realize Equivalence Principle at quantum level? If one drops this condition one can imagine very simple option obtained as tensor product of the super-symplectic and super-Kac-Moody representations. Of course, coset representations for the symplectic group and its suitable subgroup - say subgroup defining measurement resolution - can be present but would not nothing to do with Equivalence Principle.
3. One can of course argue that one has very naturally to different mass squared operators and therefore inertial and gravitational masses. Inertial mass squared would be naturally assignable to the representations of the super-symplectic algebra imbedding space d'Alembertian and gravitational mass squared with the spinor d'Alembertian at string world sheets at space-time surfaces. Quantum level realization for Equivalence Principle could mean that these two mass squared operators are identical or something analogous to this. One can however criticize this idea as un-necessary and also because the signature of the effective metric defined by the modified Dirac gamma matrices is speculated to be Euclidian.

#### 4.7.5 Constraints from p-adic mass calculations and ZEO

A further important physical input comes from p-adic thermodynamics forming a core element of p-adic mass calculations.

1. The first thing that one can get worried about relates to the extension of conformal symmetries. If the conformal symmetries generalize to  $D = 4$ , how can one take seriously the results of p-adic mass calculations based on 2-D conformal invariance? There is no reason to worry. The reduction of the conformal invariance to 2-D one for the preferred extremals takes care of this problem. This however requires that the fermionic contributions assignable to string world sheets and/or partonic 2-surfaces - Super- Kac-Moody contributions - should dictate the elementary particle masses. For hadrons also symplectic contributions should be present. This is a valuable hint in attempts to identify the mathematical structure in more detail.
2. ZEO suggests that all particles, even virtual ones correspond to massless wormhole throats carrying fermions. As a consequenc, twistor approach would work and the kinematical constraints to vertices would allow th cancellation of divergences. This would suggest that the p-adic thermal expectation value is for the longitudinal  $M^2$  momentum squared (the definition of  $CD$  selects  $M^1 \subset M^2 \subset M^4$  as also does number theoretic vision). Also propagator would be determined by  $M^2$  momentum. Lorentz invariance would be obtained by integration of the moduli for  $CD$  including also Lorentz boosts of  $CD$ .
3. In the original approach one allows states with arbitrary large values of  $L_0$  as physical states. Usually one would require that  $L_0$  annihilates the states. In the calculations however mass squared was assumed to be proportional  $L_0$  apart from vacuum contribution. This is a questionable assumption. ZEO suggests that total mass squared vanishes and that one can decompose mass squared to a sum of longitudinal and transversal parts. If one can do the same decomposition to longitudinal and transverse parts also for the Super Virasoro algebra then one can calculate longitudinal mass squared as a p-adic thermal expectation in the transversal super-Virasoro algebra and only states with  $L_0 = 0$  would contribute and one would have conformal invariance in the standard sense.
4. In the original approach the assumption motivated by Lorentz invariance has been that mass squared is replaced with conformal weight in thermodynamics, and that one first calculates the thermal average of the conformal weight and then equates it with mass squared. This assumption is somewhat ad hoc. ZEO however suggests an alternative interpretation in which one has zero energy states for which longitudinal mass squared of positive energy state derive from p-adic thermodynamics. Thermodynamics - or rather, its square root - would become part of quantum theory in ZEO.  $M$ -matrix is indeed product of hermitian square root of density

matrix multiplied by unitary S-matrix and defines the entanglement coefficients between positive and negative energy parts of zero energy state.

5. The crucial constraint is that the number of super-conformal tensor factors is  $N = 5$ : this suggests that thermodynamics applied in Super-Kac-Moody degrees of freedom assignable to string world sheets is enough, when one is interested in the masses of fermions and gauge bosons. Super-symplectic degrees of freedom can also contribute and determine the dominant contribution to baryon masses. Should also this contribution obey p-adic thermodynamics in the case when it is present? Or does the very fact that this contribution need not be present mean that it is not thermal? The symplectic contribution should correspond to hadronic p-adic length prime rather the one assignable to (say ) u quark. Hadronic p-adic mass squared and partonic p-adic mass squared cannot be summed since primes are different. If one accepts the basic rules [K46], longitudinal energy and momentum are additive as indeed assumed in perturbative QCD.
6. Calculations work if the vacuum expectation value of the mass squared must be assumed to be tachyonic. There are two options depending on whether one whether p-adic thermodynamics gives total mass squared or longitudinal mass squared.
  - (a) One could argue that the total mass squared has naturally tachyonic ground state expectation since for massless extremals longitudinal momentum is light-like and transversal momentum squared is necessary present and non-vanishing by the localization to topological light ray of finite thickness of order p-adic length scale. Transversal degrees of freedom would be modeled with a particle in a box.
  - (b) If longitudinal mass squared is what is calculated, the condition would require that transversal momentum squared is negative so that instead of plane wave like behavior exponential damping would be required. This would conform with the localization in transversal degrees of freedom.
7. What about Equivalence Principle in this framework? A possible quantum counterpart of Equivalence Principle could be that the longitudinal parts of the imbedding space mass squared operator for a given massless state equals to that for d'Alembert operator assignable to the modified Dirac action. The attempts to formulate this in more precise manner however seem to produce only additional troubles.

#### 4.7.6 The emergence of Yangian symmetry and gauge potentials as duals of Kac-Moody currents

Yangian symmetry plays a key role in  $\mathcal{N} = 4$  super-symmetric gauge theories. What is special in Yangian symmetry is that the algebra contains also multi-local generators. In TGD framework multi-locality would naturally correspond to that with respect to partonic 2-surfaces and string world sheets and the proposal has been that the Super-Kac-Moody algebras assignable to string worlds sheets could generalize to Yangian.

Witten has written a beautiful exposition of Yangian algebras [?]. Yangian is generated by two kinds of generators  $J^A$  and  $Q^A$  by a repeated formation of commutators. The number of commutations tells the integer characterizing the multi-locality and provides the Yangian algebra with grading by natural numbers. Witten describes a 2-dimensional QFT like situation in which one has 2-D situation and Kac-Moody currents assignable to real axis define the Kac-Moody charges as integrals in the usual manner. It is also assumed that the gauge potentials defined by the 1-form associated with the Kac-Moody current define a flat connection:

$$\partial_\mu j_\nu^A - \partial_\nu j_\mu^A + [j_\mu^A, j_\nu^A] = 0 \quad . \quad (4.7.1)$$

This condition guarantees that the generators of Yangian are conserved charges. One can however consider alternative manners to obtain the conservation.

1. The generators of first kind - call them  $J^A$  - are just the conserved Kac-Moody charges. The formula is given by

$$J_A = \int_{-\infty}^{\infty} dx j^{A0}(x, t) . \quad (4.7.2)$$

2. The generators of second kind contain bi-local part. They are convolutions of generators of first kind associated with different points of string described as real axis. In the basic formula one has integration over the point of real axis.

$$Q^A = f_{BC}^A \int_{-\infty}^{\infty} dx \int_x^{\infty} dy j^{B0}(x, t) j^{C0}(y, t) - 2 \int_{-\infty}^{\infty} j_x^A dx . \quad (4.7.3)$$

These charges are indeed conserved if the curvature form is vanishing as a little calculation shows.

How to generalize this to the recent context?

1. The Kac-Moody charges would be associated with the braid strands connecting two partonic 2-surfaces - Strands would be located either at the space-like 3-surfaces at the ends of the space-time surface or at light-like 3-surfaces connecting the ends. Modified Dirac equation would define Super-Kac-Moody charges as standard Noether charges. Super charges would be obtained by replacing the second quantized spinor field or its conjugate in the fermionic bilinear by particular mode of the spinor field. By replacing both spinor field and its conjugate by its mode one would obtain a conserved c-number charge corresponding to an anti-commutator of two fermionic super-charges. The convolution involving double integral is however not number theoretically attractive whereas single 1-D integrals might make sense.
2. An encouraging observation is that the Hodge dual of the Kac-Moody current defines the analog of gauge potential and exponents of the conserved Kac-Moody charges could be identified as analogs for the non-integrable phase factors for the components of this gauge potential. This identification is precise only in the approximation that generators commute since only in this case the ordered integral  $P(\exp(i \int Adx))$  reduces to  $P(\exp(i \int Adx))$ . Partonic 2-surfaces connected by braid strand would be analogous to nearby points of space-time in its discretization implying that Abelian approximation works. This conforms with the vision about finite measurement resolution as discretization in terms partonic 2-surfaces and braids.

This would make possible a direct identification of Kac-Moody symmetries in terms of gauge symmetries. For isometries one would obtain color gauge potentials and the analogs of gauge potentials for graviton field (in TGD framework the contraction with  $M^4$  vierbein would transform tensor field to 4 vector fields). For Kac-Moody generators corresponding to holonomies one would obtain electroweak gauge potentials. Note that super-charges would give rise to a collection of spartners of gauge potentials automatically. One would obtain a badly broken SUSY with very large value of  $\mathcal{N}$  defined by the number of spinor modes as indeed speculated earlier [?].

3. The condition that the gauge field defined by 1-forms associated with the Kac-Moody currents are trivial looks unphysical since it would give rise to the analog of topological QFT with gauge potentials defined by the Kac-Moody charges. For the duals of Kac-Moody currents defining gauge potentials only covariant divergence vanishes implying that curvature form is

$$F_{\alpha\beta} = \epsilon_{\alpha\beta} [j_\mu, j^\mu] , \quad (4.7.4)$$

so that the situation does not reduce to topological QFT unless the induced metric is diagonal. This is not the case in general for string world sheets.

4. It seems however that there is no need to assume that  $j_\mu$  defines a flat connection. Witten mentions that although the discretization in the definition of  $J^A$  does not seem to be possible, it makes sense for  $Q^A$  in the case of  $G = SU(N)$  for any representation of  $G$ . For general  $G$  and its general representation there exists no satisfactory definition of  $Q$ . For certain representations, such as the fundamental representation of  $SU(N)$ , the definition of  $Q^A$  is especially simple. One just takes the bi-local part of the previous formula:

$$Q^A = f_{BC}^A \sum_{i < j} J_i^B J_j^C . \quad (4.7.5)$$

What is remarkable that in this formula the summation need not refer to a discretized point of braid but to braid strands ordered by the label  $i$  by requiring that they form a connected polygon. Therefore the definition of  $J^A$  could be just as above.

5. This brings strongly in mind the interpretation in terms of twistor diagrams. Yangian would be identified as the algebra generated by the logarithms of non-integrable phase factors in Abelian approximation assigned with pairs of partonic 2-surfaces defined in terms of Kac-Moody currents assigned with the modified Dirac action. Partonic 2-surfaces connected by braid strand would be analogous to nearby points of space-time in its discretization. This would fit nicely with the vision about finite measurement resolution as discretization in terms partonic 2-surfaces and braids.

The resulting algebra satisfies the basic commutation relations

$$[J^A, J^B] = f_C^{AB} J^C , \quad [J^A, Q^B] = f_C^{AB} Q^C . \quad (4.7.6)$$

plus the rather complex Serre relations described in [?].

#### 4.7.7 Quantum criticality and electro-weak gauge symmetries

Quantum criticality is one of the basic guiding principles of Quantum TGD. What it means mathematically is however far from clear.

1. What is obvious is that quantum criticality implies quantization of Kähler coupling strength as a mathematical analog of critical temperature so that the theory becomes mathematically unique if only single critical temperature is possible. Physically this means the presence of long range fluctuations characteristic for criticality and perhaps assignable to the effective hierarchy of Planck constants having explanation in terms of effective covering spaces of the imbedding space. This hierarchy follows from the vacuum degeneracy of Kähler action, which in turn implies 4-D spin-glass degeneracy. It is easy to interpret the degeneracy in terms of criticality.
2. At more technical level one would expect criticality to corresponds deformations of a given preferred extremal defining a vanishing second variation of Kähler action. This is analogous to the vanishing of also second derivatives of potential function at extremum in certain directions so that the matrix defined by second derivatives does not have maximum rank. Entire hierarchy of criticalities is expected and a good finite-dimensional model is provided by the catastrophe theory of Thom [A16]. Cusp catastrophe [?] is the simplest catastrophe one can think of, and here the folds of cusp where discontinuous jump occurs correspond to criticality with respect to one control variable and the tip to criticality with respect to both control variables.
3. I have discussed what criticality could mean for modified Dirac action [?] and claimed that it leads to the existence of additional conserved currents defined by the variations which do not affect the value of Kähler action. These arguments are far from being mathematically rigorous and the recent view about the solutions of the modified Dirac equation predicting that the spinor modes are restricted to 2-D string world sheets requires a modification of these arguments.

In the following these arguments are updated. The unexpected result is that critical deformations induce conformal scalings of the modified metric and electro-weak gauge transformations of the induced spinor connection at  $X^2$ . Therefore holomorphy brings in the Kac-Moody symmetries associated with isometries of  $H$  (gravitation and color gauge group) and quantum criticality those associated with the holonomies of  $H$  (electro-weak-gauge group) as additional symmetries.

**The variation of modes of the induced spinor field in a variation of space-time surface respecting the preferred extremal property**

Consider first the variation of the induced spinor field in a variation of space-time surface respecting the preferred extremal property. The deformation must be such that the deformed modified Dirac operator  $D$  annihilates the modified mode. By writing explicitly the variation of the modified Dirac action (the action vanishes by modified Dirac equation) one obtains deformations and requiring its vanishing one obtains

$$\delta\Psi = D^{-1}(\delta D)\Psi . \tag{4.7.7}$$

$D^{-1}$  is the inverse of the modified Dirac operator defining the analog of Dirac propagator and  $\delta D$  defines vertex completely analogous to  $\gamma^k \delta A_k$  in gauge theory context. The functional integral over preferred extremals can be carried out perturbatively by expressing  $\delta D$  in terms of  $\delta h^k$  and one obtains stringy perturbation theory around  $X^2$  associated with the preferred extremal defining maximum of Kähler function in Euclidian region and extremum of Kähler action in Minkowskian region (stationary phase approximation).

What one obtains is stringy perturbation theory for calculating n-points functions for fermions at the ends of braid strands located at partonic 2-surfaces and representing intersections of string world sheets and partonic 2-surfaces at the light-like boundaries of  $CDs$ .  $\delta D$ - or more precisely, its partial derivatives with respect to functional integration variables - appear at the vertices located anywhere in the interior of  $X^2$  with outgoing fermions at braid ends. Bosonic propagators are replaced with correlation functions for  $\delta h^k$ . Fermionic propagator is defined by  $D^{-1}$ .

After 35 years or hard work this provides for the first time a reasonably explicit formula for the N-point functions of fermions. This is enough since by bosonic emergence [?] these N-point functions define the basic building blocks of the scattering amplitudes. Note that bosonic emergence states that bosons corresponds to wormhole contacts with fermion and antifermion at the opposite wormhole throats.

**What critical modes could mean for the induced spinor fields?**

What critical modes could mean for the induced spinor fields at string world sheets and partonic 2-surfaces. The problematic part seems to be the variation of the modified Dirac operator since it involves gradient. One cannot require that covariant derivative remains invariant since this would require that the components of the induced spinor connection remain invariant and this is quite too restrictive condition. Right handed neutrino solutions delocalized into entire  $X^2$  are however an exception since they have no electro-weak gauge couplings and in this case the condition is obvious: modified gamma matrices suffer a local scaling for critical deformations:

$$\delta\Gamma^\mu = \Lambda(x)\Gamma^\mu . \tag{4.7.8}$$

This guarantees that the modified Dirac operator  $D$  is mapped to  $\Lambda D$  and still annihilates the modes of  $\nu_R$  labelled by conformal weight, which thus remain unchanged.

What is the situation for the 2-D modes located at string world sheets? The condition is obvious.  $\Psi$  suffers an electro-weak gauge transformation as does also the induced spinor connection so that  $D_\mu$  is not affected at all. Criticality condition states that the deformation of the space-time surfaces induces a conformal scaling of  $\Gamma^\mu$  at  $X^2$ . It might be possible to continue this conformal scaling of the entire space-time sheet but this might be not necessary and this would mean that all critical deformations induced conformal transformations of the effective metric of the space-time surface defined by  $\{\Gamma^\mu, \Gamma^\nu\} = 2G^{\mu\nu}$ . Thus it seems that effective metric is indeed central concept (recall that if the

conjectured quaternionic structure is associated with the effective metric, it might be possible to avoid problem related to the Minkowskian signature in an elegant manner).

In fact, one can consider even more general action of critical deformation: the modes of the induced spinor field would be mixed together in the infinitesimal deformation besides infinitesimal electroweak gauge transformation, which is same for all modes. This would extend electroweak gauge symmetry. Modified Dirac equation holds true also for these deformations. One might wonder whether the conjectured dynamically generated gauge symmetries assignable to finite measurement resolution could be generated in this manner.

The infinitesimal generator of a critical deformation  $J_M$  can be expressed as tensor product of matrix  $A_M$  acting in the space of zero modes and of a generator of infinitesimal electro-weak gauge transformation  $T_M(x)$  acting in the same manner on all modes:  $J_M = A_M \otimes T_M(x)$ .  $A_M$  is a spatially constant matrix and  $T_M(x)$  decomposes to a direct sum of left- and right-handed  $SU(2) \times U(1)$  Lie-algebra generators. Left-handed Lie-algebra generator can be regarded as a quaternion and right handed as a complex number. One can speak of a direct sum of left-handed local quaternion  $q_{M,L}$  and right-handed local complex number  $c_{M,R}$ . The commutator  $[J_M, J_N]$  is given by  $[J_M, J_N] = [A_M, A_N] \otimes \{T_M(x), T_N(x)\} + \{A_M, A_N\} \otimes [T_M(x), T_N(x)]$ . One has  $\{T_M(x), T_N(x)\} = \{q_{M,L}(x), q_{N,L}(x)\} \oplus \{c_{M,R}(x), c_{N,R}(x)\}$  and  $[T_M(x), T_N(x)] = [q_{M,L}(x), q_{N,L}(x)]$ . The commutators make sense also for more general gauge group but quaternion/complex number property might have some deeper role.

Thus the critical deformations would induce conformal scalings of the effective metric and dynamical electro-weak gauge transformations. Electro-weak gauge symmetry would be a dynamical symmetry restricted to string world sheets and partonic 2-surfaces rather than acting at the entire space-time surface. For 4-D delocalized right-handed neutrino modes the conformal scalings of the effective metric are analogous to the conformal transformations of  $M^4$  for  $\mathcal{N} = 4$  SYMs. Also ordinary conformal symmetries of  $M^4$  could be present for string world sheets and could act as symmetries of generalized Feynman graphs since even virtual wormhole throats are massless. An interesting question is whether the conformal invariance associated with the effective metric is the analog of dual conformal invariance in  $\mathcal{N} = 4$  theories.

Critical deformations of space-time surface are accompanied by conserved fermionic currents. By using standard Noetherian formulas one can write

$$J_i^\mu = \bar{\Psi} \Gamma^\mu \delta_i \Psi + \delta_i \bar{\Psi} \Gamma^\mu \Psi . \quad (4.7.9)$$

Here  $\delta\Psi_i$  denotes derivative of the variation with respect to a group parameter labeled by  $i$ . Since  $\delta\Psi_i$  reduces to an infinitesimal gauge transformation of  $\Psi$  induced by deformation, these currents are the analogs of gauge currents. The integrals of these currents along the braid strands at the ends of string world sheets define the analogs of gauge charges. The interpretation as Kac-Moody charges is also very attractive and I have proposed that the 2-D Hodge duals of gauge potentials could be identified as Kac-Moody currents. If so, the 2-D Hodge duals of  $J$  would define the quantum analogs of dynamical electro-weak gauge fields and Kac-Moody charge could be also seen as non-integral phase factor associated with the braid strand in Abelian approximation (the interpretation in terms of finite measurement resolution is discussed earlier).

One can also define super currents by replacing  $\bar{\Psi}$  or  $\Psi$  by a particular mode of the induced spinor field as well as c-number valued currents by performing the replacement for both  $\bar{\Psi}$  or  $\Psi$ . As expected, one obtains a super-conformal algebra with all modes of induced spinor fields acting as generators of super-symmetries restricted to 2-D surfaces. The number of the charges which do not annihilate physical states as also the effective number of fermionic modes could be finite and this would suggest that the integer  $\mathcal{N}$  for the supersymmetry in question is finite. This would conform with the earlier proposal inspired by the notion of finite measurement resolution implying the replacement of the partonic 2-surfaces with collections of braid ends.

Note that Kac-Moody charges might be associated with "long" braid strands connecting different wormhole throats as well as short braid strands connecting opposite throats of wormhole contacts. Both kinds of charges would appear in the theory.



### What is the interpretation of the critical deformations?

Critical deformations bring in an additional gauge symmetry. Certainly not all possible gauge transformations are induced by the deformations of preferred extremals and a good guess is that they correspond to holomorphic gauge group elements as in theories with Kac-Moody symmetry. What is the physical character of this dynamical gauge symmetry?

1. Do the gauge charges vanish? Do they annihilate the physical states? Do only their positive energy parts annihilate the states so that one has a situation characteristic for the representation of Kac-Moody algebras. Or could some of these charges be analogous to the gauge charges associated with the constant gauge transformations in gauge theories and be therefore non-vanishing in the absence of confinement. Now one has electro-weak gauge charges and these should be non-vanishing. Can one assign them to deformations with a vanishing conformal weight and the remaining deformations to those with non-vanishing conformal weight and acting like Kac-Moody generators on the physical states?
2. The simplest option is that the critical Kac-Moody charges/gauge charges with non-vanishing positive conformal weight annihilate the physical states. Critical degrees of freedom would not disappear but make their presence known via the states labelled by different gauge charges assignable to critical deformations with vanishing conformal weight. Note that constant gauge transformations can be said to break the gauge symmetry also in the ordinary gauge theories unless one has confinement.
3. The hierarchy of quantum criticalities suggests however entire hierarchy of electro-weak Kac-Moody algebras. Does this mean a hierarchy of electro-weak symmetries breakings in which the number of Kac-Moody generators not annihilating the physical states gradually increases as also modes with a higher value of positive conformal weight fail to annihilate the physical state?

The only manner to have a hierarchy of algebras is by assuming that only the generators satisfying  $n \bmod N = 0$  define the sub-Kac-Moody algebra annihilating the physical states so that the generators with  $n \bmod N \neq 0$  would define the analogs of gauge charges. I have suggested for long time ago the relevance of kind of fractal hierarchy of Kac-Moody and Super-Virasoro algebras for TGD but failed to imagine any concrete realization.

A stronger condition would be that the algebra reduces to a finite dimensional algebra in the sense that the actions of generators  $Q_n$  and  $Q_{n+kN}$  are identical. This would correspond to periodic boundary conditions in the space of conformal weights. The notion of finite measurement resolution suggests that the number of independent fermionic oscillator operators is proportional to the number of braid ends so that an effective reduction to a finite algebra is expected.

Whatever the correct interpretation is, this would obviously refine the usual view about electro-weak symmetry breaking.

These arguments suggests the following overall view. The holomorphy of spinor modes gives rise to Kac-Moody algebra defined by isometries and includes besides Minkowskian generators associated with gravitation also SU(3) generators associated with color symmetries. Vanishing second variations in turn define electro-weak Kac-Moody type algebra.

Note that criticality suggests that one must perform functional integral over WCW by decomposing it to an integral over zero modes for which deformations of  $X^4$  induce only an electro-weak gauge transformation of the induced spinor field and to an integral over moduli corresponding to the remaining degrees of freedom.

#### 4.7.8 The importance of being light-like

The singular geometric objects associated with the space-time surface have become increasingly important in TGD framework. In particular, the recent progress has made clear that these objects might be crucial for the understanding of quantum TGD. The singular objects are associated not only with the induced metric but also with the effective metric defined by the anti-commutators of the modified gamma matrices appearing in the modified Dirac equation and determined by the Kähler action.

### The singular objects associated with the induced metric

Consider first the singular objects associated with the induced metric.

1. At light-like 3-surfaces defined by wormhole throats the signature of the induced metric changes from Euclidian to Minkowskian so that 4-metric is degenerate. These surfaces are carriers of elementary particle quantum numbers and the 4-D induced metric degenerates locally to 3-D one at these surfaces.
2. Braid strands at light-like 3-surfaces are most naturally light-like curves: this correspond to the boundary condition for open strings. One can assign fermion number to the braid strands. Braid strands allow an identification as curves along which the Euclidian signature of the string world sheet in Euclidian region transforms to Minkowskian one. Number theoretic interpretation would be as a transformation of complex regions to hyper-complex regions meaning that imaginary unit  $i$  satisfying  $i^2 = -1$  becomes hyper-complex unit  $e$  satisfying  $e^2 = 1$ . The complex coordinates  $(z, \bar{z})$  become hyper-complex coordinates  $(u = t + ex, v = t - ex)$  giving the standard light-like coordinates when one puts  $e = 1$ .

### The singular objects associated with the effective metric

There are also singular objects assignable to the effective metric. According to the simple arguments already developed, string world sheets and possibly also partonic 2-surfaces are singular objects with respect to the effective metric defined by the anti-commutators of the modified gamma matrices rather than induced gamma matrices. Therefore the effective metric seems to be much more than a mere formal structure.

1. For instance, quaternionicity of the space-time surface could allow an elegant formulation in terms of the effective metric avoiding the problems due to the Minkowski signature. This is achieved if the effective metric has Euclidian signature  $\epsilon \times (1, 1, 1, 1)$ ,  $\epsilon = \pm 1$  or a complex counterpart of the Minkowskian signature  $\epsilon(1, 1, -1, -1)$ .
2. String world sheets and perhaps also partonic 2-surfaces could be understood as singularities of the effective metric. What happens that the effective metric with Euclidian signature  $\epsilon \times (1, 1, 1, 1)$  transforms to the signature  $\epsilon(1, 1, -1, -1)$  (say) at string world sheet so that one would have the degenerate signature  $\epsilon \times (1, 1, 0, 0)$  at the string world sheet.

What is amazing is that this works also number theoretically. It came as a total surprise to me that the notion of hyper-quaternions as a closed algebraic structure indeed exists. The hyper-quaternionic units would be given by  $(1, I, iJ, iK)$ , where  $i$  is a commuting imaginary unit satisfying  $i^2 = -1$ . Hyper-quaternionic numbers defined as combinations of these units with real coefficients do form a closed algebraic structure which however fails to be a number field just like hyper-complex numbers do. Note that the hyper-quaternions obtained with real coefficients from the basis  $(1, iI, iJ, iK)$  fail to form an algebra since the product is not hyper-quaternion in this sense but belongs to the algebra of complexified quaternions. The same problem is encountered in the case of hyper-octonions defined in this manner. This has been a stone in my shoe since I feel strong disrelish towards Wick rotation as a trick for moving between different signatures.

3. Could also partonic 2-surfaces correspond to this kind of singular 2-surfaces? In principle, 2-D surfaces of 4-D space intersect at discrete points just as string world sheets and partonic 2-surfaces do so that this might make sense. By complex structure the situation is algebraically equivalent to the analog of plane with non-flat metric allowing all possible signatures  $(\epsilon_1, \epsilon_2)$  in various regions. At light-like curve either  $\epsilon_1$  or  $\epsilon_2$  changes sign and light-like curves for these two kinds of changes can intersect as one can easily verify by drawing what happens. At the intersection point the metric is completely degenerate and simply vanishes.
4. Replacing real 2-dimensionality with complex 2-dimensionality, one obtains by the universality of algebraic dimension the same result for partonic 2-surfaces and string world sheets. The braid ends at partonic 2-surfaces representing the intersection points of 2-surfaces of this kind would have completely degenerate effective metric so that the modified gamma matrices would vanish implying that energy momentum tensor vanishes as does also the induced Kähler field.

5. The effective metric suffers a local conformal scaling in the critical deformations identified in the proposed manner. Since ordinary conformal group acts on Minkowski space and leaves the boundary of light-cone invariant, one has two conformal groups. It is not however clear whether the  $M^4$  conformal transformations can act as symmetries in TGD, where the presence of the induced metric in Kähler action breaks  $M^4$  conformal symmetry. As found, also in TGD framework the Kac-Moody currents assigned to the braid strands generate Yangian: this is expected to be true also for the Kac-Moody counterparts of the conformal algebra associated with quantum criticality. On the other hand, in twistor program one encounters also two conformal groups and the space in which the second conformal group acts remains somewhat mysterious object. The Lie algebras for the two conformal groups generate the conformal Yangian and the integrands of the scattering amplitudes are Yangian invariants. Twistor approach should apply in TGD if zero energy ontology is right. Does this mean a deep connection?

What is also intriguing that twistor approach in principle works in strict mathematical sense only at signatures  $\epsilon \times (1, 1, -1 - 1)$  and the scattering amplitudes in Minkowski signature are obtained by analytic continuation. Could the effective metric give rise to the desired signature? Note that the notion of massless particle does not make sense in the signature  $\epsilon \times (1, 1, 1, 1)$ .

These arguments provide genuine a support for the notion of quaternionicity and suggest a connection with the twistor approach.

#### 4.7.9 Realization of large $\mathcal{N}$ SUSY in TGD

The generators large  $\mathcal{N}$  SUSY algebras are obtained by taking fermionic currents for second quantized fermions and replacing either fermion field or its conjugate with its particular mode. The resulting super currents are conserved and define super charges. By replacing both fermion and its conjugate with modes one obtains c number valued currents. Therefore  $\mathcal{N} = \infty$  SUSY - presumably equivalent with super-conformal invariance - or its finite  $\mathcal{N}$  cutoff is realized in TGD framework and the challenge is to understand the realization in more detail.

#### Super-space viz. Grassmann algebra valued fields

Standard SUSY induces super-space extending space-time by adding anti-commuting coordinates as a formal tool. Many mathematicians are not enthusiastic about this approach because of the purely formal nature of anti-commuting coordinates. Also I regard them as a non-sense geometrically and there is actually no need to introduce them as the following little argument shows.

Grassmann parameters (anti-commuting theta parameters) are generators of Grassmann algebra and the natural object replacing super-space is this Grassmann algebra with coefficients of Grassmann algebra basis appearing as ordinary real or complex coordinates. This is just an ordinary space with additional algebraic structure: the mysterious anti-commuting coordinates are not needed. To me this notion is one of the conceptual monsters created by the over-pragmatic thinking of theoreticians.

This allows allows to replace field space with super field space, which is completely well-defined object mathematically, and leave space-time untouched. Linear field space is simply replaced with its Grassmann algebra. For non-linear field space this replacement does not work. This allows to formulate the notion of linear super-field just in the same manner as it is done usually.

The generators of super-symmetries in super-space formulation reduce to super translations, which anti-commute to translations. The super generators  $Q_\alpha$  and  $\bar{Q}_{\dot{\beta}}$  of super Poincare algebra are Weyl spinors commuting with momenta and anti-commuting to momenta:

$$\{Q_\alpha, \bar{Q}_{\dot{\beta}}\} = 2\sigma_{\alpha\dot{\beta}}^\mu P_\mu . \quad (4.7.10)$$

One particular representation of super generators acting on super fields is given by

$$\begin{aligned} D_\alpha &= i \frac{\partial}{\partial \theta_\alpha} , \\ D_{\dot{\alpha}} &= i \frac{\partial}{\partial \bar{\theta}_{\dot{\alpha}}} + \theta^\beta \sigma_{\beta\dot{\alpha}}^\mu \partial_\mu \end{aligned} \quad (4.7.11)$$

Here the index raising for 2-spinors is carried out using antisymmetric 2-tensor  $\epsilon^{\alpha\beta}$ . Super-space interpretation is not necessary since one can interpret this action as an action on Grassmann algebra valued field mixing components with different fermion numbers.

Chiral superfields are defined as fields annihilated by  $D_{\dot{\alpha}}$ . Chiral fields are of form  $\Psi(x^\mu + i\bar{\theta}\sigma^\mu\theta, \theta)$ . The dependence on  $\theta_{\dot{\alpha}}$  comes only from its presence in the translated Minkowski coordinate annihilated by  $D_{\dot{\alpha}}$ . Super-space enthusiast would say that by a translation of  $M^4$  coordinates chiral fields reduce to fields, which depend on  $\theta$  only.

### The space of fermionic Fock states at partonic 2-surface as TGD counterpart of chiral super field

As already noticed, another manner to realize SUSY in terms of representations the super algebra of conserved super-charges. In TGD framework these super charges are naturally associated with the modified Dirac equation, and anti-commuting coordinates and super-fields do not appear anywhere. One can however ask whether one could identify a mathematical structure replacing the notion of chiral super field.

In [?] it was proposed that generalized chiral super-fields could effectively replace induced spinor fields and that second quantized fermionic oscillator operators define the analog of SUSY algebra. One would have  $\mathcal{N} = \infty$  if all the conformal excitations of the induced spinor field restricted on 2-surface are present. For right-handed neutrino the modes are labeled by two integers and delocalized to the interior of Euclidian or Minkowskian regions of space-time sheet.

The obvious guess is that chiral super-field generalizes to the field having as its components many-fermions states at partonic 2-surfaces with theta parameters and their conjugates in one-one correspondence with fermionic creation operators and their hermitian conjugates.

1. Fermionic creation operators - in classical theory corresponding anti-commuting Grassmann parameters - replace theta parameters. Theta parameters and their conjugates are not in one-one correspondence with spinor components but with the fermionic creation operators and their hermitian conjugates. One can say that the super-field in question is defined in the "world of classical worlds" (WCW) rather than in space-time. Fermionic Fock state at the partonic 2-surface is the value of the chiral super field at particular point of WCW.
2. The matrix defined by the  $\sigma^\mu\partial_\mu$  is replaced with a matrix defined by the modified Dirac operator  $D$  between spinor modes acting in the solution space of the modified Dirac equation. Since modified Dirac operator annihilates the modes of the induced spinor field, super covariant derivatives reduce to ordinary derivatives with respect the theta parameters labeling the modes. Hence the chiral super field is a field that depends on  $\theta_m$  or conjugates  $\bar{\theta}_m$  only. In second quantization the modes of the chiral super-field are many-fermion states assigned to partonic 2-surfaces and string world sheets. Note that this is the only possibility since the notion of super-coordinate does not make sense now.
3. It would seem that the notion of super-field does not bring anything new. This is not the case. First of all, the spinor fields are restricted to 2-surfaces. Second point is that one cannot assign to the fermions of the many-fermion states separate non-parallel or even parallel four-momenta. The many-fermion state behaves like elementary particle. This has non-trivial implications for propagators and a simple argument [?] leads to the proposal that propagator for N-fermion partonic state is proportional to  $1/p^N$ . This would mean that only the states with fermion number equal to 1 or 2 behave like ordinary elementary particles.

### How the fermionic anti-commutation relations are determined?

Understanding the fermionic anti-commutation relations is not trivial since all fermion fields except right-handed neutrino are assumed to be localized at 2-surfaces. Since fermionic conserved currents must give rise to well-defined charges as 3-D integrals the spinor modes must be proportional to a square root of delta function in normal directions. Furthermore, the modified Dirac operator must act only in the directions tangential to the 2-surface in order that the modified Dirac equation can be satisfied.

The square root of delta function can be formally defined by starting from the expansion of delta function in discrete basis for a particle in 1-D box. The product of two functions in x-space is convolution of Fourier transforms and the coefficients of Fourier transform of delta function are apart from a constant multiplier equal to 1:  $\delta(x) = K \sum_n \exp(inx/2\pi L)$ . Therefore the Fourier transform of square root of delta function is obtained by normalizing the Fourier transform of delta function by  $1/\sqrt{N}$ , where  $N \rightarrow \infty$  is the number of plane waves. In other words:  $\sqrt{\delta(x)} = \sqrt{\frac{K}{N}} \sum_n \exp(inx/2\pi L)$ .

Canonical quantization defines the standard approach to the second quantization of the Dirac equation.

1. One restricts the consideration to time=constant slices of space-time surface. Now the 3-surfaces at the ends of  $CD$  are natural slices. The intersection of string world sheet with these surfaces is 1-D whereas partonic 2-surfaces have 2-D Euclidian intersection with them.
2. The canonical momentum density is defined by

$$\begin{aligned} \Pi_\alpha &= \frac{\partial L}{\partial_t \bar{\Psi}_\alpha(x)} = \Gamma^t \Psi \ , \\ \Gamma^t &= \frac{\partial L_K}{\partial(\partial_t h^k)} \ . \end{aligned} \tag{4.7.12}$$

$L_K$  denotes Kähler action density: consistency requires  $D_\mu \Gamma^\mu = 0$ , and this is guaranteed only by using the modified gamma matrices defined by Kähler action. Note that  $\Gamma^t$  contains also the  $\sqrt{g_4}$  factor. Induced gamma matrices would require action defined by four-volume.  $t$  is time coordinate varying in direction tangential to 2-surface.

3. The standard equal time canonical anti-commutation relations state

$$\{\Pi_\alpha, \bar{\Psi}_\beta\} = \delta^3(x, y) \delta_{\alpha\beta} \ . \tag{4.7.13}$$

Can these conditions be applied both at string world sheets and partonic 2-surfaces.

1. String world sheets do not pose problems. The restriction of the modes to string world sheets means that the square root of delta function in the normal direction of string world sheet takes care of the normal dimensions and the dynamical part of anti-commutation relations is 1-dimensional just as in the case of strings.
2. Partonic 2-surfaces are problematic. The  $\sqrt{g_4}$  factor in  $\Gamma^t$  implies that  $\Gamma^t$  approaches zero at partonic 2-surfaces since they belong to light-like wormhole throats at which the signature of the induced metric changes. Energy momentum tensor appearing in  $\Gamma^t$  involves to index raisins by induced metric so that it can grow without limit as one approaches partonic two-surface. Therefore it is quite possible that the limit is finite and the boundary conditions defined by the weak form of electric magnetic duality might imply that the limit is finite. The open question is whether one can apply canonical quantization at partonic 2-surfaces. One can also ask whether one can define induced spinor fields at wormhole throats only at the ends of string world sheets so that partonic 2-surface would be effectively discretized. This cautious conclusion emerged in the earlier study of the modified Dirac equation [?].
3. Suppose that one can assume spinor modes at partonic 2-surfaces. 2-D conformal invariance suggests that the situation reduces to effectively one-dimensional also at the partonic two-surfaces. If so, one should pose the anti-commutation relations at some 1-D curves of the partonic 2-surface only. This is the only sensible option. The point is that the action of the modified Dirac operator is tangential so that also the canonical momentum current must be tangential and one can fix anti-commutations only at some set of curves of the partonic 2-surface.

One can of course worry what happens at the limit of vacuum extremals. The problem is that  $\Gamma^t$  vanishes for space-time surfaces reducing to vacuum extremals at the 2-surfaces carrying fermions so that the anti-commutations are inconsistent. Should one require - as done earlier- that the anti-commutation relations make sense at this limit and cannot therefore have the standard form but involve the scalar magnetic flux formed from the induced Kähler form by permuting it with the 2-D permutations symbol? The restriction to preferred extremals, which are always non-vacuum extremals, might allow to avoid this kind of problems automatically.

In the case of right-handed neutrino the situation is genuinely 3-dimensional and in this case non-vacuum extremal property must hold true in the regions where the modes of  $\nu_R$  are non-vanishing. The same mechanism would save from problems also at the partonic 2-surfaces. The dynamics of induced spinor fields must avoid classical vacuum. Could this relate to color confinement? Could hadrons be surrounded by an insulating layer of Kähler vacuum?

## 4.8 Generalization of the notion of imbedding space

This section summarizes the the attempt to understand how the hierarchy of Planck constants is realized at the level of imbedding space and what quantum criticality for phase transitions changing Planck constant means.

### 4.8.1 Generalization of the notion of imbedding space

The original idea was that the proposed modification of the imbedding space could explain naturally phenomena like quantum Hall effect involving fractionization of quantum numbers like spin and charge. This does not however seem to be the case.  $G_a \times G_b$  implies just the opposite if these quantum numbers are assigned with the symmetries of the imbedding space. For instance, quantization unit for orbital angular momentum becomes  $n_a$  where  $Z_{n_a}$  is the maximal cyclic subgroup of  $G_a$ .

One can however imagine of obtaining fractionization at the level of imbedding space for space-time sheets, which are analogous to multi-sheeted Riemann surfaces (say Riemann surfaces associated with  $z^{1/n}$  since the rotation by  $2\pi$  understood as a homotopy of  $M^4$  lifted to the space-time sheet is a non-closed curve. Continuity requirement indeed allows fractionization of the orbital quantum numbers and color in this kind of situation.

#### Both covering spaces and factor spaces are possible

The observation above stimulates the question whether it might be possible in some sense to replace  $H$  or its factors by their multiple coverings.

1. This is certainly not possible for  $M^4$ ,  $CP_2$ , or  $H$  since their fundamental groups are trivial. On the other hand, the fixing of quantization axes implies a selection of the sub-space  $H_4 = M^2 \times S^2 \subset M^4 \times CP_2$ , where  $S^2$  is a geodesic sphere of  $CP_2$ .  $\hat{M}^4 = M^4 \setminus M^2$  and  $\hat{CP}_2 = CP_2 \setminus S^2$  have fundamental group  $Z$  since the codimension of the excluded sub-manifold is equal to two and homotopically the situation is like that for a punctured plane. The exclusion of these sub-manifolds defined by the choice of quantization axes could naturally give rise to the desired situation.
2.  $H_4$  represents a straight cosmic string. Quantum field theory phase corresponds to Jones inclusions with Jones index  $\mathcal{M} : \mathcal{N} < 4$ . Stringy phase would by previous arguments correspond to  $\mathcal{M} : \mathcal{N} = 4$ . Also these Jones inclusions are labeled by finite subgroups of  $SO(3)$  and thus by  $Z_n$  identified as a maximal Abelian subgroup.

One can argue that cosmic strings are not allowed in QFT phase. This would encourage the replacement  $\hat{M}^4 \times \hat{CP}_2$  implying that surfaces in  $M^4 \times S^2$  and  $M^2 \times CP_2$  are not allowed. In particular, cosmic strings and  $CP_2$  type extremals with  $M^4$  projection in  $M^2$  and thus light-like geodesic without zitterbewegung essential for massivation are forbidden. This brings in mind instability of Higgs=0 phase.

3. The covering spaces in question would correspond to the Cartesian products  $\hat{M}^4_{n_a} \times \hat{CP}_{2n_b}$  of the covering spaces of  $\hat{M}^4$  and  $\hat{CP}_2$  by  $Z_{n_a}$  and  $Z_{n_b}$  with fundamental group is  $Z_{n_a} \times$

$Z_{n_b}$ . One can also consider extension by replacing  $M^2$  and  $S^2$  with its orbit under  $G_a$  (say tetrahedral, octahedral, or icosahedral group). The resulting space will be denoted by  $\hat{M}^4 \hat{\times} G_a$  resp.  $\hat{CP}_2 \hat{\times} G_b$ .

4. One expects the discrete subgroups of  $SU(2)$  emerge naturally in this framework if one allows the action of these groups on the singular sub-manifolds  $M^2$  or  $S^2$ . This would replace the singular manifold with a set of its rotated copies in the case that the subgroups have genuinely 3-dimensional action (the subgroups which corresponds to exceptional groups in the ADE correspondence). For instance, in the case of  $M^2$  the quantization axes for angular momentum would be replaced by the set of quantization axes going through the vertices of tetrahedron, octahedron, or icosahedron. This would bring non-commutative homotopy groups into the picture in a natural manner.
5. Also the orbifolds  $\hat{M}^4/G_a \times \hat{CP}_2/G_b$  can be allowed as also the spaces  $\hat{M}^4/G_a \times (\hat{CP}_2 \hat{\times} G_b)$  and  $(\hat{M}^4 \hat{\times} G_a) \times \hat{CP}_2/G_b$ . Hence the previous framework would generalize considerably by the allowance of both coset spaces and covering spaces.

There are several non-trivial questions related to the details of the gluing procedure and phase transition as motion of partonic 2-surface from one sector of the imbedding space to another one.

1. How the gluing of copies of imbedding space at  $M^2 \times CP_2$  takes place? It would seem that the covariant metric of  $M^4$  factor proportional to  $\hbar^2$  must be discontinuous at the singular manifold since only in this manner the idea about different scaling factor of  $M^4$  metric can make sense. This is consistent with the identical vanishing of Chern-Simons action in  $M^2 \times S^2$ .
2. One might worry whether the phase transition changing Planck constant means an instantaneous change of the size of partonic 2-surface in  $M^4$  degrees of freedom. This is not the case. Light-likeness in  $M^2 \times S^2$  makes sense only for surfaces  $X^1 \times D^2 \subset M^2 \times S^2$ , where  $X^1$  is light-like geodesic. The requirement that the partonic 2-surface  $X^2$  moving from one sector of  $H$  to another one is light-like at  $M^2 \times S^2$  irrespective of the value of Planck constant requires that  $X^2$  has single point of  $M^2$  as  $M^2$  projection. Hence no sudden change of the size  $X^2$  occurs.
3. A natural question is whether the phase transition changing the value of Planck constant can occur purely classically or whether it is analogous to quantum tunneling. Classical non-vacuum extremals of Chern-Simons action have two-dimensional  $CP_2$  projection to homologically non-trivial geodesic sphere  $S^2_I$ . The deformation of the entire  $S^2_I$  to homologically trivial geodesic sphere  $S^2_{II}$  is not possible so that only combinations of partonic 2-surfaces with vanishing total homology charge (Kähler magnetic charge) can in principle move from sector to another one, and this process involves fusion of these 2-surfaces such that  $CP_2$  projection becomes single homologically trivial 2-surface. A piece of a non-trivial geodesic sphere  $S^2_I$  of  $CP_2$  can be deformed to that of  $S^2_{II}$  using 2-dimensional homotopy flattening the piece of  $S^2$  to curve. If this homotopy cannot be chosen to be light-like, the phase transitions changing Planck constant take place only via quantum tunneling. Obviously the notions of light-like homotopies (cobordisms) and classical light-like homotopies (cobordisms) are very relevant for the understanding of phase transitions changing Planck constant.

### Do factor spaces and coverings correspond to the two kinds of Jones inclusions?

What could be the interpretation of these two kinds of spaces?

1. Jones inclusions appear in two varieties corresponding to  $\mathcal{M} : \mathcal{N} < 4$  and  $\mathcal{M} : \mathcal{N} = 4$  and one can assign a hierarchy of subgroups of  $SU(2)$  with both of them. In particular, their maximal Abelian subgroups  $Z_n$  label these inclusions. The interpretation of  $Z_n$  as invariance group is natural for  $\mathcal{M} : \mathcal{N} < 4$  and it naturally corresponds to the coset spaces. For  $\mathcal{M} : \mathcal{N} = 4$  the interpretation of  $Z_n$  has remained open. Obviously the interpretation of  $Z_n$  as the homology group defining covering would be natural.
2.  $\mathcal{M} : \mathcal{N} = 4$  should correspond to the allowance of cosmic strings and other analogous objects. Does the introduction of the covering spaces bring in cosmic strings in some controlled manner?

Formally the subgroup of  $SU(2)$  defining the inclusion is  $SU(2)$  would mean that states are  $SU(2)$  singlets which is something non-physical. For covering spaces one would however obtain the degrees of freedom associated with the discrete fiber and the degrees of freedom in question would not disappear completely and would be characterized by the discrete subgroup of  $SU(2)$ .

For anyons the non-trivial homotopy of plane brings in non-trivial connection with a flat curvature and the non-trivial dynamics of topological QFTs. Also now one might expect similar non-trivial contribution to appear in the spinor connection of  $\hat{M}^2 \hat{\times} G_a$  and  $\hat{CP}_2 \hat{\times} G_b$ . In conformal field theory models non-trivial monodromy would correspond to the presence of punctures in plane.

3. For factor spaces the unit for quantum numbers like orbital angular momentum is multiplied by  $n_a$  resp.  $n_b$  and for coverings it is divided by this number. These two kind of spaces are in a well defined sense obtained by multiplying and dividing the factors of  $\hat{H}$  by  $G_a$  resp.  $G_b$  and multiplication and division are expected to relate to Jones inclusions with  $\mathcal{M} : \mathcal{N} < 4$  and  $\mathcal{M} : \mathcal{N} = 4$ , which both are labeled by a subset of discrete subgroups of  $SU(2)$ .
4. The discrete subgroups of  $SU(2)$  with fixed quantization axes possess a well defined multiplication with product defined as the group generated by forming all possible products of group elements as elements of  $SU(2)$ . This product is commutative and all elements are idempotent and thus analogous to projectors. Trivial group  $G_1$ , two-element group  $G_2$  consisting of reflection and identity, the cyclic groups  $Z_p$ ,  $p$  prime, and tetrahedral, octahedral, and icosahedral groups are the generators of this algebra.

By commutativity one can regard this algebra as an 11-dimensional module having natural numbers as coefficients ("rig"). The trivial group  $G_1$ , two-element group  $G_2$ ; generated by reflection, and tetrahedral, octahedral, and icosahedral groups define 5 generating elements for this algebra. The products of groups other than trivial group define 10 units for this algebra so that there are 11 units altogether. The groups  $Z_p$  generate a structure analogous to natural numbers acting as analog of coefficients of this structure. Clearly, one has effectively 11-dimensional commutative algebra in 1-1 correspondence with the 11-dimensional "half-lattice"  $N^{11}$  ( $N$  denotes natural numbers). Leaving away reflections, one obtains  $N^7$ . The projector representation suggests a connection with Jones inclusions. An interesting question concerns the possible Jones inclusions assignable to the subgroups containing infinitely manner elements. Reader has of course already asked whether dimensions 11, 7 and their difference 4 might relate somehow to the mathematical structures of M-theory with 7 compactified dimensions. One could introduce generalized configuration space spinor fields in the configuration space labeled by sectors of  $H$  with given quantization axes. By introducing Fourier transform in  $N^{11}$  one would formally obtain an infinite-component field in 11-D space.

5. How do the Planck constants associated with factors and coverings relate? One might argue that Planck constant defines a homomorphism respecting the multiplication and division (when possible) by  $G_i$ . If so, then Planck constant in units of  $\hbar_0$  would be equal to  $n_a/n_b$  for  $\hat{H}/G_a \times G_b$  option and  $n_b/n_a$  for  $\hat{H} \hat{\times} (G_a \times G_b)$  with obvious formulas for hybrid cases. This option would put  $M^4$  and  $CP_2$  in a very symmetric role and allow much more flexibility in the identification of symmetries associated with large Planck constant phases.

### 4.8.2 Phase transitions changing the value of Planck constant

There are two basic kinds of phase transitions changing the value of Planck constant inducing a leakage between sectors of imbedding space. There are three cases to consider corresponding to

1. leakage in  $M^4$  degrees of freedom changing  $G_a$ : the critical manifold is  $R_+ \times CP_2$ ;
2. leakage in  $CP_2$  degrees of freedom changing  $G_b$ : the critical manifold is  $\delta M_+^4 \times S_{II}^2$ ;
3. leakage in both degrees of freedom changing both  $G_a$  and  $G_b$ : the critical manifold is  $R_+ \times S_{II}^2$ . This is the non-generic case

For transitions of type 2) and 3)  $X^2$  must go through vacuum extremal in the classical picture about transition.



Covering space can also change to a factor space in both degrees of freedom or vice versa and in this case  $G$  can remain unchanged as a group although its interpretation changes.

The phase transitions satisfy also strong group theoretical constraints. For the transition  $G_1 \rightarrow G_2$  either  $G_1 \subset G_2$  or  $G_2 \subset G_1$  must hold true. For maximal cyclic subgroups  $Z_n$  associated with quantization axes this means that  $n_1$  must divide  $n_2$  or vice versa. Hence a nice number theoretic view about transitions emerges.

One can classify the points of critical manifold according to the degree of criticality. Obviously the maximally critical points corresponds to fixed points of  $G_i$  that its points  $z = 0, \infty$  of the spheres  $S_r^2$  and  $S_{II}^2$ . In the case of  $\delta M_+^4$  the points  $z = 0$  and  $\infty$  correspond to the light-like rays  $R_+$  in opposite directions. This ray would define the quantization direction of angular momentum. Quantum phase transitions changing the value of  $M^4$  Planck constant could occur anywhere along this ray (partonic 2-surface would have 1-D projection along this ray). At the level of cosmology this would bring in a preferred direction. Light-cone dip, the counterpart of big bang, is the maximally quantum critical point since it remains invariant under entire group  $SO(3, 1)$ .

Interesting questions relate to the groups generated by finite discrete subgroups of  $SO(3)$ . As noticed the groups generated as products of groups leaving  $R_+$  invariant and three genuinely 3-D groups are infinite discrete subgroups of  $SO(3)$  and could also define Jones inclusions. In this case orbifold is replaced with orbifold containing infinite number of rotated versions of  $R_+$ . These phases could be important in elementary particle length scales or in early cosmology.

### 4.8.3 Could the dynamics of Kähler action predict the hierarchy of Planck constants?

The original justification for the hierarchy of Planck constants came from the indications that Planck constant could have large values in both astrophysical systems involving dark matter and also in biology. The realization of the hierarchy in terms of the singular coverings and possibly also factor spaces of  $CD$  and  $CP_2$  emerged from consistency conditions. The formula for the Planck constant involves heuristic guess work and physical plausibility arguments. There are good arguments in favor of the hypothesis that only coverings are possible. Only a finite number of pages of the Big Book correspond to a given value of Planck constant, biological evolution corresponds to a gradual dispersion to the pages of the Big Book with larger Planck constant, and a connection with the hierarchy of infinite primes and p-adicization program based on the mathematical realization of finite measurement resolution emerges.

One can however ask whether this hierarchy could emerge directly from the basic quantum TGD rather than as a separate hypothesis. The following arguments suggest that this might be possible. One finds also a precise geometric interpretation of preferred extremal property interpreted as criticality in zero energy ontology.

#### 1-1 correspondence between canonical momentum densities and time derivatives fails for Kähler action

The basic motivation for the geometrization program was the observation that canonical quantization for TGD fails. To see what is involved let us try to perform a canonical quantization in zero energy ontology at the 3-D surfaces located at the light-like boundaries of  $CD \times CP_2$ .

1. In canonical quantization canonical momentum densities  $\pi_k^0 \equiv \pi_k = \partial L_K / \partial(\partial_0 h^k)$ , where  $\partial_0 h^k$  denotes the time derivative of imbedding space coordinate, are the physically natural quantities in terms of which to fix the initial values: once their value distribution is fixed also conserved charges are fixed. Also the weak form of electric-magnetic duality given by  $J^{03} \sqrt{g_4} = 4\pi\alpha_K J_{12}$  and a mild generalization of this condition to be discussed below can be interpreted as a manner to fix the values of conserved gauge charges (not Noether charges) to their quantized values since Kähler magnetic flux equals to the integer giving the homology class of the (wormhole) throat. This condition alone need not characterize criticality, which requires an infinite number of deformations of  $X^4$  for which the second variation of the Kähler action vanishes and implies infinite number conserved charges. This in fact gives hopes of replacing  $\pi_k$  with these conserved Noether charges.

2. Canonical quantization requires that  $\partial_0 h^k$  in the energy is expressed in terms of  $\pi_k$ . The equation defining  $\pi_k$  in terms of  $\partial_0 h^k$  is however highly non-linear although algebraic. By taking squares the equations reduces to equations for rational functions of  $\partial_0 h^k$ .  $\partial_0 h^k$  appears in contravariant and covariant metric at most quadratically and in the induced Kähler electric field linearly and by multiplying the equations by  $\det(g_4)^3$  one can transform the equations to a polynomial form so that in principle  $\partial_0 h^k$  can be obtained as a solution of polynomial equations.
3. One can always eliminate one half of the coordinates by choosing 4 imbedding space coordinates as the coordinates of the spacetime surface so that the initial value conditions reduce to those for the canonical momentum densities associated with the remaining four coordinates. For instance, for space-time surfaces representable as map  $M^4 \rightarrow CP_2$   $M^4$  coordinates are natural and the time derivatives  $\partial_0 s^k$  of  $CP_2$  coordinates are multivalued. One would obtain four polynomial equations with  $\partial_0 s^k$  as unknowns. In regions where  $CP_2$  projection is 4-dimensional -in particular for the deformations of  $CP_2$  vacuum extremals the natural coordinates are  $CP_2$  coordinates and one can regard  $\partial_0 m^k$  as unknowns. For the deformations of cosmic strings, which are of form  $X^4 = X^2 \times Y^2 \subset M^4 \times CP_2$ , one can use coordinates of  $M^2 \times S^2$ , where  $S^2$  is geodesic sphere as natural coordinates and regard as unknowns  $E^2$  coordinates and remaining  $CP_2$  coordinates.
4. One can imagine solving one of the four polynomial equations for time derivatives in terms of other obtaining  $N$  roots. Then one would substitute these roots to the remaining 3 conditions to obtain algebraic equations from which one solves then second variable. Obviously situation is very complex without additional symmetries. The criticality of the preferred extremals might however give additional conditions allowing simplifications. The reasons for giving up the canonical quantization program was following. For the vacuum extremals of Kähler action  $\pi_k$  are however identically vanishing and this means that there is an infinite number of value distributions for  $\partial_0 h^k$ . For small deformations of vacuum extremals one might however hope a finite number of solutions to the conditions and thus finite number of space-time surfaces carrying same conserved charges.

If one assumes that physics is characterized by the values of the conserved charges one must treat the many-valuedness of  $\partial_0 h^k$ . The most obvious guess is that one should replace the space of space-like 4-surfaces corresponding to different roots  $\partial_0 h^k = F^k(\pi_l)$  with four-surfaces in the covering space of  $CD \times CP_2$  corresponding to different branches of the many-valued function  $\partial_0 h^k = F(\pi_l)$  co-inciding at the ends of  $CD$ .

**Do the coverings forced by the many-valuedness of  $\partial_0 h^k$  correspond to the coverings associated with the hierarchy of Planck constants?**

The obvious question is whether this covering space actually corresponds to the covering spaces associated with the hierarchy of Planck constants. This would conform with quantum classical correspondence. The hierarchy of Planck constants and hierarchy of covering spaces was introduced to cure the failure of the perturbation theory at quantum level. At classical level the multivaluedness of  $\partial_0 h^k$  means a failure of perturbative canonical quantization and forces the introduction of the covering spaces. The interpretation would be that when the density of matter becomes critical the space-time surface splits to several branches so that the density at each branches is sub-critical. It is of course not at all obvious whether the proposed structure of the Big Book is really consistent with this hypothesis and one also consider modifications of this structure if necessary. The manner to proceed is by making questions.

1. The proposed picture would give only single integer characterizing the covering. Two integers assignable to  $CD$  and  $CP_2$  degrees of freedom are however needed. How these two coverings could emerge?
  - (a) One should fix also the values of  $\pi_k^n = \partial L_K / \partial h_n^k$ , where  $n$  refers to space-like normal coordinate at the wormhole throats. If one requires that charges do not flow between regions with different signatures of the metric the natural condition is  $\pi_k^n = 0$  and allows also multi-valued solution. Since wormhole throats carry magnetic charge and since weak form of electric-magnetic duality is assumed, one can assume that  $CP_2$  projection is four-dimensional so that one can use  $CP_2$  coordinates and regard  $\partial_0 m^k$  as unknowns. The basic

idea about topological condensation in turn suggests that  $M^4$  projection can be assumed to be 4-D inside space-like 3-surfaces so that here  $\partial_0 s^k$  are the unknowns. At partonic 2-surfaces one would have conditions for both  $\pi_k^0$  and  $\pi_k^n$ . One might hope that the numbers of solutions are finite for preferred extremals because of their symmetries and given by  $n_a$  for  $\partial_0 m^k$  and by  $n_b$  for  $\partial_0 s^k$ . The optimistic guess is that  $n_a$  and  $n_b$  corresponds to the numbers of sheets for singular coverings of  $CD$  and  $CP_2$ . The covering could be visualized as replacement of space-time surfaces with space-time surfaces which have  $n_a n_b$  branches.  $n_b$  branches would degenerate to single branch at the ends of diagrams of the generated Feynman graph and  $n_a$  branches would degenerate to single one at wormhole throats.

- (b) This picture is not quite correct yet. The fixing of  $\pi_k^0$  and  $\pi_k^n$  should relate closely to the effective 2-dimensionality as an additional condition perhaps crucial for criticality. One could argue that both  $\pi_k^0$  and  $\pi_k^n$  must be fixed at  $X^3$  and  $X_l^3$  in order to effectively bring in dynamics in two directions so that  $X^3$  could be interpreted as a an orbit of partonic 2-surface in space-like direction and  $X_l^3$  as its orbit in light-like direction. The additional conditions could be seen as gauge conditions made possible by symplectic and Kac-Moody type conformal symmetries. The conditions for  $\pi_0^k$  would give  $n_b$  branches in  $CP_2$  degrees of freedom and the conditions for  $\pi_k^n$  would split each of these branches to  $n_a$  branches.
  - (c) The existence of these two kinds of conserved charges (possibly vanishing for  $\pi_k^n$ ) could relate also very closely to the slicing of the space-time sheets by string world sheets and partonic 2-surfaces.
2. Should one then treat these branches as separate space-time surfaces or as a single space-time surface? The treatment as a single surface seems to be the correct thing to do. Classically the conserved changes would be  $n_a n_b$  times larger than for single branch. Kähler action need not (but could!) be same for different branches but the total action is  $n_a n_b$  times the average action and this effectively corresponds to the replacement of the  $\hbar_0/g_K^2$  factor of the action with  $\hbar/g_K^2$ ,  $r \equiv \hbar/\hbar_0 = n_a n_b$ . Since the conserved quantum charges are proportional to  $\hbar$  one could argue that  $r = n_a n_b$  tells only that the charge conserved charge is  $n_a n_b$  times larger than without multi-valuedness.  $\hbar$  would be only effectively  $n_a n_b$  fold. This is of course poor man's argument but might catch something essential about the situation.
  3. How could one interpret the condition  $J^{03}\sqrt{g_4} = 4\pi\alpha_K J_{12}$  and its generalization to be discussed below in this framework? The first observation is that the total Kähler electric charge is by  $\alpha_K \propto 1/(n_a n_b)$  same always. The interpretation would be in terms of charge fractionization meaning that each branch would carry Kähler electric charge  $Q_K = ng_K/n_a n_b$ . I have indeed suggested explanation of charge fractionization and quantum Hall effect based on this picture.
  4. The vision about the hierarchy of Planck constants involves also assumptions about imbedding space metric. The assumption that the  $M^4$  covariant metric is proportional to  $\hbar^2$  follows from the physical idea about  $\hbar$  scaling of quantum lengths as what Compton length is. One can always introduce scaled  $M^4$  coordinates bringing  $M^4$  metric into the standard form by scaling up the  $M^4$  size of  $CD$ . It is not clear whether the scaling up of  $CD$  size follows automatically from the proposed scenario. The basic question is why the  $M^4$  size scale of the critical extremals must scale like  $n_a n_b$ ? This should somehow relate to the weak self-duality conditions implying that Kähler field at each branch is reduced by a factor  $1/r$  at each branch. Field equations should possess a dynamical symmetry involving the scaling of  $CD$  by integer  $k$  and  $J^{0\beta}\sqrt{g_4}$  and  $J^{n\beta}\sqrt{g_4}$  by  $1/k$ . The scaling of  $CD$  should be due to the scaling up of the  $M^4$  time interval during which the branched light-like 3-surface returns back to a non-branched one.
  5. The proposed view about hierarchy of Planck constants is that the singular coverings reduce to single-sheeted coverings at  $M^2 \subset M^4$  for  $CD$  and to  $S^2 \subset CP_2$  for  $CP_2$ . Here  $S^2$  is any homologically trivial geodesic sphere of  $CP_2$  and has vanishing Kähler form. Weak self-duality condition is indeed consistent with any value of  $\hbar$  and implies that the vacuum property for the partonic 2-surface implies vacuum property for the entire space-time sheet as holography indeed requires. This condition however generalizes. In weak self-duality conditions the value of  $\hbar$  is free for any 2-D Lagrangian sub-manifold of  $CP_2$ .

The branching along  $M^2$  would mean that the branches of preferred extremals always collapse to single branch when their  $M^4$  projection belongs to  $M^2$ . Magnetically charged light-light-like

throats cannot have  $M^4$  projection in  $M^2$  so that self-duality conditions for different values of  $\hbar$  do not lead to inconsistencies. For spacelike 3-surfaces at the boundaries of  $CD$  the condition would mean that the  $M^4$  projection becomes light-like geodesic. Straight cosmic strings would have  $M^2$  as  $M^4$  projection. Also  $CP_2$  type vacuum extremals for which the random light-like projection in  $M^4$  belongs to  $M^2$  would represent this of situation. One can ask whether the degeneration of branches actually takes place along any string like object  $X^2 \times Y^2$ , where  $X^2$  defines a minimal surface in  $M^4$ . For these the weak self-duality condition would imply  $\hbar = \infty$  at the ends of the string. It is very plausible that string like objects feed their magnetic fluxes to larger space-times sheets through wormhole contacts so that these conditions are not encountered.

### Connection with the criticality of preferred extremals

Also a connection with quantum criticality and the criticality of the preferred extremals suggests itself. Criticality for the preferred extremals must be a property of space-like 3-surfaces and light-like 3-surfaces with degenerate 4-metric and the degeneration of the  $n_a n_b$  branches of the space-time surface at the its ends and at wormhole throats is exactly what happens at criticality. For instance, in catastrophe theory roots of the polynomial equation giving extrema of a potential as function of control parameters co-incide at criticality. If this picture is correct the hierarchy of Planck constants would be an outcome of criticality and of preferred extremal property and preferred extremals would be just those multi-branched space-time surfaces for which branches co-incide at the the boundaries of  $CD \times CP_2$  and at the throats.

# Mathematics

- [A1] Gaussian Mersenne. <http://primes.utm.edu/glossary/xpage/GaussianMersenne.html>.
- [A2] Z. I. Borevich and I. R. Shafarevich. *Number Theory*. Academic Press, 1966.
- [A3] Eisenhart. *Riemannian Geometry*. Princeton University Press, 1964.
- [A4] C. N. Pope G. W. Gibbons.  $CP_2$  as gravitational instanton. *Comm. Math. Phys.*, 55, 1977.
- [A5] W. Hawking, S. and N. Pope, C. Generalized Spin Structures in Quantum Gravity. *Phys. Lett.*, (1), 1978.
- [A6] S. Helgason. *Differential Geometry and Symmetric Spaces*. Academic Press, New York, 1962.
- [A7] C. Itzykson and J-B. Zuber. *Quantum Field Theory*, volume 549. Mc Graw-Hill, New York, 1980.
- [A8] J. Milnor. *Topology form Differential Point of View*. The University Press of Virginia, Virginia, 1965.
- [A9] D. S. Moak. The q-analogue of the Laguerre polynomials. *J. Math. Anal. Appl.*, 81, 1981.
- [A10] N. Pope, C. Eigenfunctions and  $Spin^c$  Structures on  $CP_2$ , 1980.
- [A11] B. Shipman. The geometry of momentum mappings on generalized flag manifolds, connections with a dynamical system, quantum mechanics and the dance of honeybee. <http://math.cornell.edu/~oliver/Shipman.gif>, 1998.
- [A12] M. Spivak. *Differential Geometry I,II,III,IV*. Publish or Perish, Boston, 1970.
- [A13] J. Hanson T. Eguchi, B. Gilkey. *Phys. Rep.*, 66:1980, 1980.
- [A14] R. Thom. *Commentarii Math. Helvet.*, 28, 1954.
- [A15] Wallace. *Differential Topology*. W. A. Benjamin, New York, 1968.
- [A16] E. C. Zeeman. *Catastrophe Theory*. Addison-Wessley Publishing Company, 1977.



# Theoretical Physics

- [B1] J. Björken and S. Drell. *Relativistic Quantum Fields*. Mc Graw-Hill, New York, 1965.
- [B2] K. Huang. *Quarks, Leptons & Gauge Fields*. World Scientific, 1982.
- [B3] R. Kiehn. Electromagnetic waves in vacuum with torsion and spin. <http://www22.pair.com/csdc/pdf/helical6.pdf>.
- [B4] G. Parisi. *Field Theory, Disorder and Simulations*. World Scientific, 1992.
- [B5] A. Zee. *The Unity of Forces in the Universe*. World Science Press, Singapore, 1982.





# Books related to TGD

- [K1] M. Pitkänen. 1983.
- [K2] M. Pitkänen. Is it Possible to Understand Coupling Constant Evolution at Space-Time Level? In *Towards M-Matrix*. Onlinebook. [http://tgdtheory.com/public\\_html/tgdquant/tgdquant.html#rgflow](http://tgdtheory.com/public_html/tgdquant/tgdquant.html#rgflow), 2006.
- [K3] M. Pitkänen. About Strange Effects Related to Rotating Magnetic Systems . In *TGD and Fringe Physics*. Onlinebook. [http://tgdtheory.com/public\\_html/freenergy/freenergy.html#Faraday](http://tgdtheory.com/public_html/freenergy/freenergy.html#Faraday), 2006.
- [K4] M. Pitkänen. About the New Physics Behind Qualia. In *Quantum Hardware of Living Matter*. Onlinebook. [http://tgdtheory.com/public\\_html/bioware/bioware.html#newphys](http://tgdtheory.com/public_html/bioware/bioware.html#newphys), 2006.
- [K5] M. Pitkänen. An Overview about Quantum TGD: Part I. In *Topological Geometrodynamics: Overview*. Onlinebook. [http://tgdtheory.com/public\\_html/tgdview/tgdview.html#evoII](http://tgdtheory.com/public_html/tgdview/tgdview.html#evoII), 2006.
- [K6] M. Pitkänen. An Overview about the Evolution of Quantum TGD. In *Topological Geometrodynamics: Overview*. Onlinebook. [http://tgdtheory.com/public\\_html/tgdview/tgdview.html#evoI](http://tgdtheory.com/public_html/tgdview/tgdview.html#evoI), 2006.
- [K7] M. Pitkänen. Anomalies Related to the Classical  $Z^0$  Force and Gravitation. In *TGD and Fringe Physics*. Onlinebook. [http://tgdtheory.com/public\\_html/freenergy/freenergy.html#Zanom](http://tgdtheory.com/public_html/freenergy/freenergy.html#Zanom), 2006.
- [K8] M. Pitkänen. Appendix A: Quantum Groups and Related Structures. In *Towards M-Matrix*. Onlinebook. [http://tgdtheory.com/public\\_html/tgdquant/tgdquant.html#bialgebra](http://tgdtheory.com/public_html/tgdquant/tgdquant.html#bialgebra), 2006.
- [K9] M. Pitkänen. Basic Extremals of Kähler Action. In *Physics in Many-Sheeted Space-Time*. Onlinebook. [http://tgdtheory.com/public\\_html/tgdclass/tgdclass.html#class](http://tgdtheory.com/public_html/tgdclass/tgdclass.html#class), 2006.
- [K10] M. Pitkänen. *Bio-Systems as Conscious Holograms*. Onlinebook. [http://tgdtheory.com/public\\_html/hologram/hologram.html](http://tgdtheory.com/public_html/hologram/hologram.html), 2006.
- [K11] M. Pitkänen. Bio-Systems as Conscious Holograms. In *Bio-Systems as Conscious Holograms*. Onlinebook. [http://tgdtheory.com/public\\_html/hologram/hologram.html#hologram](http://tgdtheory.com/public_html/hologram/hologram.html#hologram), 2006.
- [K12] M. Pitkänen. *Bio-Systems as Self-Organizing Quantum Systems*. Onlinebook. [http://tgdtheory.com/public\\_html/bioselforg/bioselforg.html](http://tgdtheory.com/public_html/bioselforg/bioselforg.html), 2006.
- [K13] M. Pitkänen. Bio-Systems as Super-Conductors: part I. In *Quantum Hardware of Living Matter*. Onlinebook. [http://tgdtheory.com/public\\_html/bioware/bioware.html#superc1](http://tgdtheory.com/public_html/bioware/bioware.html#superc1), 2006.
- [K14] M. Pitkänen. Bio-Systems as Super-Conductors: part II. In *Quantum Hardware of Living Matter*. Onlinebook. [http://tgdtheory.com/public\\_html/bioware/bioware.html#superc2](http://tgdtheory.com/public_html/bioware/bioware.html#superc2), 2006.
- [K15] M. Pitkänen. Configuration Space Spinor Structure. In *Quantum Physics as Infinite-Dimensional Geometry*. Onlinebook. [http://tgdtheory.com/public\\_html/tgdgeom/tgdgeom.html#cspin](http://tgdtheory.com/public_html/tgdgeom/tgdgeom.html#cspin), 2006.

- [K16] M. Pitkänen. Construction of elementary particle vacuum functionals. In *p-Adic Length Scale Hypothesis and Dark Matter Hierarchy*. Onlinebook. [http://tgdtheory.com/public\\_html/paddark/paddark.html#elvafu](http://tgdtheory.com/public_html/paddark/paddark.html#elvafu), 2006.
- [K17] M. Pitkänen. Construction of Quantum Theory: M-matrix. In *Towards M-Matrix*. Onlinebook. [http://tgdtheory.com/public\\_html/tgdquant/tgdquant.html#towards](http://tgdtheory.com/public_html/tgdquant/tgdquant.html#towards), 2006.
- [K18] M. Pitkänen. Cosmic Strings. In *Physics in Many-Sheeted Space-Time*. Onlinebook. [http://tgdtheory.com/public\\_html/tgdclass/tgdclass.html#cstrings](http://tgdtheory.com/public_html/tgdclass/tgdclass.html#cstrings), 2006.
- [K19] M. Pitkänen. Crop Circles and Life at Parallel Space-Time Sheets. In *Magnetospheric Consciousness*. Onlinebook. [http://tgdtheory.com/public\\_html/magnconsc/magnconsc.html#crop1](http://tgdtheory.com/public_html/magnconsc/magnconsc.html#crop1), 2006.
- [K20] M. Pitkänen. Crop Circles and Life at Parallel Space-Time Sheets. In *Magnetospheric Consciousness*. Onlinebook. [http://tgdtheory.com/public\\_html/magnconsc/magnconsc.html#crop2](http://tgdtheory.com/public_html/magnconsc/magnconsc.html#crop2), 2006.
- [K21] M. Pitkänen. Dark Forces and Living Matter. In *p-Adic Length Scale Hypothesis and Dark Matter Hierarchy*. Onlinebook. [http://tgdtheory.com/public\\_html/paddark/paddark.html#darkforces](http://tgdtheory.com/public_html/paddark/paddark.html#darkforces), 2006.
- [K22] M. Pitkänen. Dark Matter Hierarchy and Hierarchy of EEGs. In *TGD and EEG*. Onlinebook. [http://tgdtheory.com/public\\_html/tgdeeg/tgdeeg.html#eegdark](http://tgdtheory.com/public_html/tgdeeg/tgdeeg.html#eegdark), 2006.
- [K23] M. Pitkänen. Dark Nuclear Physics and Condensed Matter. In *p-Adic Length Scale Hypothesis and Dark Matter Hierarchy*. Onlinebook. [http://tgdtheory.com/public\\_html/paddark/paddark.html#exonuclear](http://tgdtheory.com/public_html/paddark/paddark.html#exonuclear), 2006.
- [K24] M. Pitkänen. DNA as Topological Quantum Computer. In *Genes and Memes*. Onlinebook. [http://tgdtheory.com/public\\_html/genememe/genememe.html#dnatqc](http://tgdtheory.com/public_html/genememe/genememe.html#dnatqc), 2006.
- [K25] M. Pitkänen. Does TGD Predict the Spectrum of Planck Constants? In *Towards M-Matrix*. Onlinebook. [http://tgdtheory.com/public\\_html/tgdquant/tgdquant.html#Planck](http://tgdtheory.com/public_html/tgdquant/tgdquant.html#Planck), 2006.
- [K26] M. Pitkänen. Evolution in Many-Sheeted Space-Time. In *Genes and Memes*. Onlinebook. [http://tgdtheory.com/public\\_html/genememe/genememe.html#prebio](http://tgdtheory.com/public_html/genememe/genememe.html#prebio), 2006.
- [K27] M. Pitkänen. General Ideas about Many-Sheeted Space-Time: Part I. In *Physics in Many-Sheeted Space-Time*. Onlinebook. [http://tgdtheory.com/public\\_html/tgdclass/tgdclass.html#topcond](http://tgdtheory.com/public_html/tgdclass/tgdclass.html#topcond), 2006.
- [K28] M. Pitkänen. General Theory of Qualia. In *Bio-Systems as Conscious Holograms*. Onlinebook. [http://tgdtheory.com/public\\_html/hologram/hologram.html#qualia](http://tgdtheory.com/public_html/hologram/hologram.html#qualia), 2006.
- [K29] M. Pitkänen. *Genes and Memes*. Onlinebook. [http://tgdtheory.com/public\\_html/genememe/genememe.html](http://tgdtheory.com/public_html/genememe/genememe.html), 2006.
- [K30] M. Pitkänen. Genes and Memes. In *Genes and Memes*. Onlinebook. [http://tgdtheory.com/public\\_html/genememe/genememe.html#genememec](http://tgdtheory.com/public_html/genememe/genememe.html#genememec), 2006.
- [K31] M. Pitkänen. Homeopathy in Many-Sheeted Space-Time. In *Bio-Systems as Conscious Holograms*. Onlinebook. [http://tgdtheory.com/public\\_html/hologram/hologram.html#homeoc](http://tgdtheory.com/public_html/hologram/hologram.html#homeoc), 2006.
- [K32] M. Pitkänen. Macro-Temporal Quantum Coherence and Spin Glass Degeneracy. In *Bio-Systems as Conscious Holograms*. Onlinebook. [http://tgdtheory.com/public\\_html/hologram/hologram.html#macro](http://tgdtheory.com/public_html/hologram/hologram.html#macro), 2006.
- [K33] M. Pitkänen. Macroscopic Quantum Coherence and Quantum Metabolism as Different Sides of the Same Coin. In *Bio-Systems as Conscious Holograms*. Onlinebook. [http://tgdtheory.com/public\\_html/hologram/hologram.html#metab](http://tgdtheory.com/public_html/hologram/hologram.html#metab), 2006.

- [K34] M. Pitkänen. Macroscopic Quantum Phenomena and  $CP_2$  Geometry. In *Physics in Many-Sheeted Space-Time*. Onlinebook. [http://tgdtheory.com/public\\_html/tgdclass/tgdclass.html#super](http://tgdtheory.com/public_html/tgdclass/tgdclass.html#super), 2006.
- [K35] M. Pitkänen. Magnetic Sensory Canvas Hypothesis. In *TGD and EEG*. Onlinebook. [http://tgdtheory.com/public\\_html//tgdeeg/tgdeeg/tgdeeg.html#mec](http://tgdtheory.com/public_html//tgdeeg/tgdeeg/tgdeeg.html#mec), 2006.
- [K36] M. Pitkänen. *Magnetospheric Consciousness*. Onlinebook. [http://tgdtheory.com/public\\_html/magnconsc/magnconsc.html](http://tgdtheory.com/public_html/magnconsc/magnconsc.html), 2006.
- [K37] M. Pitkänen. Magnetospheric Sensory Representations. In *Magnetospheric Consciousness*. Onlinebook. [http://tgdtheory.com/public\\_html/magnconsc/magnconsc.html#srepres](http://tgdtheory.com/public_html/magnconsc/magnconsc.html#srepres), 2006.
- [K38] M. Pitkänen. Many-Sheeted DNA. In *Genes and Memes*. Onlinebook. [http://tgdtheory.com/public\\_html/genememe/genememe.html#genecodec](http://tgdtheory.com/public_html/genememe/genememe.html#genecodec), 2006.
- [K39] M. Pitkänen. Massless states and particle massivation. In *p-Adic Length Scale Hypothesis and Dark Matter Hierarchy*. Onlinebook. [http://tgdtheory.com/public\\_html/paddark/paddark.html#mless](http://tgdtheory.com/public_html/paddark/paddark.html#mless), 2006.
- [K40] M. Pitkänen. *Mathematical Aspects of Consciousness Theory*. Onlinebook. [http://tgdtheory.com/public\\_html/mathconsc/mathconsc.html](http://tgdtheory.com/public_html/mathconsc/mathconsc.html), 2006.
- [K41] M. Pitkänen. Matter, Mind, Quantum. In *TGD Inspired Theory of Consciousness*. Onlinebook. [http://tgdtheory.com/public\\_html/tgdconsc/tgdconsc.html#conscic](http://tgdtheory.com/public_html/tgdconsc/tgdconsc.html#conscic), 2006.
- [K42] M. Pitkänen. Negentropy Maximization Principle. In *TGD Inspired Theory of Consciousness*. Onlinebook. [http://tgdtheory.com/public\\_html/tgdconsc/tgdconsc.html#nmpc](http://tgdtheory.com/public_html/tgdconsc/tgdconsc.html#nmpc), 2006.
- [K43] M. Pitkänen. New Particle Physics Predicted by TGD: Part I. In *p-Adic Length Scale Hypothesis and Dark Matter Hierarchy*. Onlinebook. [http://tgdtheory.com/public\\_html/paddark/paddark.html#mass4](http://tgdtheory.com/public_html/paddark/paddark.html#mass4), 2006.
- [K44] M. Pitkänen. Nuclear String Hypothesis. In *p-Adic Length Scale Hypothesis and Dark Matter Hierarchy*. Onlinebook. [http://tgdtheory.com/public\\_html/paddark/paddark.html#nuclstring](http://tgdtheory.com/public_html/paddark/paddark.html#nuclstring), 2006.
- [K45] M. Pitkänen. *p-Adic length Scale Hypothesis and Dark Matter Hierarchy*. Onlinebook. [http://tgdtheory.com/public\\_html/paddark/paddark.html](http://tgdtheory.com/public_html/paddark/paddark.html), 2006.
- [K46] M. Pitkänen. p-Adic Particle Massivation: Hadron Masses. In *p-Adic Length Scale Hypothesis and Dark Matter Hierarchy*. Onlinebook. [http://tgdtheory.com/public\\_html/paddark/paddark.html#mass3](http://tgdtheory.com/public_html/paddark/paddark.html#mass3), 2006.
- [K47] M. Pitkänen. p-Adic Physics as Physics of Cognition and Intention. In *TGD Inspired Theory of Consciousness*. Onlinebook. [http://tgdtheory.com/public\\_html/tgdconsc/tgdconsc.html#cognic](http://tgdtheory.com/public_html/tgdconsc/tgdconsc.html#cognic), 2006.
- [K48] M. Pitkänen. *Physics in Many-Sheeted Space-Time*. Onlinebook. [http://tgdtheory.com/public\\_html/tgdclass/tgdclass.html](http://tgdtheory.com/public_html/tgdclass/tgdclass.html), 2006.
- [K49] M. Pitkänen. Quantum Antenna Hypothesis. In *Quantum Hardware of Living Matter*. Onlinebook. [http://tgdtheory.com/public\\_html/bioware/bioware.html#tubuc](http://tgdtheory.com/public_html/bioware/bioware.html#tubuc), 2006.
- [K50] M. Pitkänen. Quantum Astrophysics. In *Physics in Many-Sheeted Space-Time*. Onlinebook. [http://tgdtheory.com/public\\_html/tgdclass/tgdclass.html#qastro](http://tgdtheory.com/public_html/tgdclass/tgdclass.html#qastro), 2006.
- [K51] M. Pitkänen. Quantum Control and Coordination in Bio-systems: Part I. In *Bio-Systems as Self-Organizing Quantum Systems*. Onlinebook. [http://tgdtheory.com/public\\_html/bioselforg/bioselforg.html#qcococI](http://tgdtheory.com/public_html/bioselforg/bioselforg.html#qcococI), 2006.
- [K52] M. Pitkänen. Quantum Control and Coordination in Bio-Systems: Part II. In *Bio-Systems as Self-Organizing Quantum Systems*. Onlinebook. [http://tgdtheory.com/public\\_html/bioselforg/bioselforg.html#qcococII](http://tgdtheory.com/public_html/bioselforg/bioselforg.html#qcococII), 2006.

- [K53] M. Pitkänen. *Quantum Hardware of Living Matter*. Onlinebook. [http://tgdtheory.com/public\\_html/bioware/bioware.html](http://tgdtheory.com/public_html/bioware/bioware.html), 2006.
- [K54] M. Pitkänen. Quantum Model for Hearing. In *TGD and EEG*. Onlinebook. [http://tgdtheory.com/public\\_html//tgdeeg/tgdeeg/tgdeeg.html#hearing](http://tgdtheory.com/public_html//tgdeeg/tgdeeg/tgdeeg.html#hearing), 2006.
- [K55] M. Pitkänen. Quantum Model for Nerve Pulse. In *TGD and EEG*. Onlinebook. [http://tgdtheory.com/public\\_html//tgdeeg/tgdeeg/tgdeeg.html#pulse](http://tgdtheory.com/public_html//tgdeeg/tgdeeg/tgdeeg.html#pulse), 2006.
- [K56] M. Pitkänen. Quantum Model for Paranormal Phenomena. In *TGD Inspired Theory of Consciousness*. Onlinebook. [http://tgdtheory.com/public\\_html/tgdconsc/tgdconsc.html#parac](http://tgdtheory.com/public_html/tgdconsc/tgdconsc.html#parac), 2006.
- [K57] M. Pitkänen. Quantum Model for Sensory Representations. In *TGD Inspired Theory of Consciousness*. Onlinebook. [http://tgdtheory.com/public\\_html/tgdconsc/tgdconsc.html#expc](http://tgdtheory.com/public_html/tgdconsc/tgdconsc.html#expc), 2006.
- [K58] M. Pitkänen. Quantum Model of EEG. In *TGD and EEG*. Onlinebook. [http://tgdtheory.com/public\\_html/tgdeeg/tgdeeg.html#eegII](http://tgdtheory.com/public_html/tgdeeg/tgdeeg.html#eegII), 2006.
- [K59] M. Pitkänen. Quantum Model of Memory. In *TGD Inspired Theory of Consciousness*. Onlinebook. [http://tgdtheory.com/public\\_html/tgdconsc/tgdconsc.html#memoryc](http://tgdtheory.com/public_html/tgdconsc/tgdconsc.html#memoryc), 2006.
- [K60] M. Pitkänen. *Quantum Physics as Infinite-Dimensional Geometry*. Onlinebook. [http://tgdtheory.com/public\\_html/tgdgeom/tgdgeom.html](http://tgdtheory.com/public_html/tgdgeom/tgdgeom.html), 2006.
- [K61] M. Pitkänen. *Quantum TGD*. Onlinebook. [http://tgdtheory.com/public\\_html/tgdquant/tgdquant.html](http://tgdtheory.com/public_html/tgdquant/tgdquant.html), 2006.
- [K62] M. Pitkänen. Quantum Theory of Self-Organization. In *Bio-Systems as Self-Organizing Quantum Systems*. Onlinebook. [http://tgdtheory.com/public\\_html/bioselforg/bioselforg.html#selforgac](http://tgdtheory.com/public_html/bioselforg/bioselforg.html#selforgac), 2006.
- [K63] M. Pitkänen. Semi-trance, Mental Illness, and Altered States of Consciousness. In *Magnetospheric Consciousness*. Onlinebook. [http://tgdtheory.com/public\\_html/magnconsc/magnconsc.html#semitrancec](http://tgdtheory.com/public_html/magnconsc/magnconsc.html#semitrancec), 2006.
- [K64] M. Pitkänen. Semitrance, Language, and Development of Civilization. In *Magnetospheric Consciousness*. Onlinebook. [http://tgdtheory.com/public\\_html/magnconsc/magnconsc.html#langsoc](http://tgdtheory.com/public_html/magnconsc/magnconsc.html#langsoc), 2006.
- [K65] M. Pitkänen. TGD and Astrophysics. In *Physics in Many-Sheeted Space-Time*. Onlinebook. [http://tgdtheory.com/public\\_html/tgdclass/tgdclass.html#astro](http://tgdtheory.com/public_html/tgdclass/tgdclass.html#astro), 2006.
- [K66] M. Pitkänen. TGD and Cosmology. In *Physics in Many-Sheeted Space-Time*. Onlinebook. [http://tgdtheory.com/public\\_html/tgdclass/tgdclass.html#cosmo](http://tgdtheory.com/public_html/tgdclass/tgdclass.html#cosmo), 2006.
- [K67] M. Pitkänen. *TGD and EEG*. Onlinebook. [http://tgdtheory.com/public\\_html/tgdeeg/tgdeeg.html](http://tgdtheory.com/public_html/tgdeeg/tgdeeg.html), 2006.
- [K68] M. Pitkänen. *TGD and Fringe Physics*. Onlinebook. [http://tgdtheory.com/public\\_html/freenergy/freenergy.html](http://tgdtheory.com/public_html/freenergy/freenergy.html), 2006.
- [K69] M. Pitkänen. TGD and Nuclear Physics. In *p-Adic Length Scale Hypothesis and Dark Matter Hierarchy*. Onlinebook. [http://tgdtheory.com/public\\_html/paddark/paddark.html#padnucl](http://tgdtheory.com/public_html/paddark/paddark.html#padnucl), 2006.
- [K70] M. Pitkänen. *TGD as a Generalized Number Theory*. Onlinebook. [http://tgdtheory.com/public\\_html/tgdnumber/tgdnumber.html](http://tgdtheory.com/public_html/tgdnumber/tgdnumber.html), 2006.
- [K71] M. Pitkänen. TGD as a Generalized Number Theory: p-Adicization Program. In *TGD as a Generalized Number Theory*. Onlinebook. [http://tgdtheory.com/public\\_html/tgdnumber/tgdnumber.html#visiona](http://tgdtheory.com/public_html/tgdnumber/tgdnumber.html#visiona), 2006.

- [K72] M. Pitkänen. TGD as a Generalized Number Theory: Quaternions, Octonions, and their Hyper Counterparts. In *TGD as a Generalized Number Theory*. Onlinebook. [http://tgdtheory.com/public\\_html/tgdnumber/tgdnumber.html#visionb](http://tgdtheory.com/public_html/tgdnumber/tgdnumber.html#visionb), 2006.
- [K73] M. Pitkänen. TGD Based Model for OBEs. In *TGD Inspired Theory of Consciousness*. Onlinebook. [http://tgdtheory.com/public\\_html/tgdconsc/tgdconsc.html#OBE](http://tgdtheory.com/public_html/tgdconsc/tgdconsc.html#OBE), 2006.
- [K74] M. Pitkänen. *TGD Inspired Theory of Consciousness*. Onlinebook. [http://tgdtheory.com/public\\_html/tgdconsc/tgdconsc.html](http://tgdtheory.com/public_html/tgdconsc/tgdconsc.html), 2006.
- [K75] M. Pitkänen. TGD Inspired Theory of Consciousness. In *Topological Geometrodynamics: Overview*. Onlinebook. [http://tgdtheory.com/public\\_html/tgdview/tgdview.html#tgdconsc2010](http://tgdtheory.com/public_html/tgdview/tgdview.html#tgdconsc2010), 2006.
- [K76] M. Pitkänen. The Notion of Free Energy and Many-Sheeted Space-Time Concept. In *TGD and Fringe Physics*. Onlinebook. [http://tgdtheory.com/public\\_html/freenergy/freenergy.html#freenergy](http://tgdtheory.com/public_html/freenergy/freenergy.html#freenergy), 2006.
- [K77] M. Pitkänen. The Relationship Between TGD and GRT. In *Physics in Many-Sheeted Space-Time*. Onlinebook. [http://tgdtheory.com/public\\_html/tgdclass/tgdclass.html#tgdgrt](http://tgdtheory.com/public_html/tgdclass/tgdclass.html#tgdgrt), 2006.
- [K78] M. Pitkänen. Three new physics realizations of the genetic code and the role of dark matter in bio-systems. In *Genes and Memes*. Onlinebook. [http://tgdtheory.com/public\\_html/genememe/genememe.html#dnatqccodes](http://tgdtheory.com/public_html/genememe/genememe.html#dnatqccodes), 2006.
- [K79] M. Pitkänen. Time, Spacetime and Consciousness. In *Bio-Systems as Conscious Holograms*. Onlinebook. [http://tgdtheory.com/public\\_html/hologram/hologram.html#time](http://tgdtheory.com/public_html/hologram/hologram.html#time), 2006.
- [K80] M. Pitkänen. *Topological Geometrodynamics: an Overview*. Onlinebook. [http://tgdtheory.com/public\\_html/tgdview/tgdview.html](http://tgdtheory.com/public_html/tgdview/tgdview.html), 2006.
- [K81] M. Pitkänen. Topological Quantum Computation in TGD Universe. In *Genes and Memes*. Onlinebook. [http://tgdtheory.com/public\\_html/genememe/genememe.html#tqc](http://tgdtheory.com/public_html/genememe/genememe.html#tqc), 2006.
- [K82] M. Pitkänen. Was von Neumann Right After All. In *Towards M-Matrix*. Onlinebook. [http://tgdtheory.com/public\\_html/tgdquant/tgdquant.html#vNeumann](http://tgdtheory.com/public_html/tgdquant/tgdquant.html#vNeumann), 2006.
- [K83] M. Pitkänen. Wormhole Magnetic Fields. In *Quantum Hardware of Living Matter*. Onlinebook. [http://tgdtheory.com/public\\_html/bioware/bioware.html#wormc](http://tgdtheory.com/public_html/bioware/bioware.html#wormc), 2006.



# Articles about TGD

- [L1] M. Pitkänen. Macro-temporal quantum coherence, quantum spin glass degeneracy, and number theoretic information concept. <http://www.emergentmind.org/journal.htm>, 2003.
- [L2] M. Pitkänen. Time, Space-Time, and Consciousness. <http://www.emergentmind.org/journal.htm>, 2003.
- [L3] M. Pitkänen. Further Progress in Nuclear String Hypothesis. <http://tgdtheory.com/articles/nuclstring.pdf>, 2007.
- [L4] M. Pitkänen. TGD based solution of Fermi paradox. <http://www.physics.helsinki.fi/~matpitka/articles/fermieng.pdf>, 2007.





## Chapter 5

# Construction of Quantum Theory: *M*-matrix

### 5.1 Introduction

During years I have spent a lot of time and effort in attempts to imagine various options for the construction of *S*-matrix, and it seems that there are quite many strong constraints, which might lead to a more or less unique final result if some young analytically blessed brain decided to transform these assumptions to concrete calculational recipes.

The realization that configuration space spinors correspond to von Neumann algebras known as hyper-finite factors of type  $II_1$  meant [K82, K25] a turning point also in the attempts to construct *S*-matrix. A sequence of trials and errors led rapidly to the generalization of the quantum measurement theory and re-interpretation of *S*-matrix elements as entanglement coefficients of zero energy states in accordance with the zero energy ontology applied already earlier in TGD inspired cosmology [?]. Zero energy ontology motivated the replacement of the term '*S*-matrix' with '*M*-matrix'. This led to the discovery that rather stringy formulas for *M*-matrix elements emerge in TGD framework.

The purpose of this chapter is to collect to single chapter various general ideas about the construction of *M*-matrix scattered in the chapters of books about TGD and often drowned into details and plagued by side tracks. My hope is that this chapter might provide a kind of bird's eye of view and help the reader to realize how fascinating and profound and near to physics the mathematics of hyper-finite factors is. I do not pretend of having handle about the huge technical complexities and can only recommend the works of von Neumann [?, ?, ?, ?], Tomita [?], [?, ?, ?], the work of Powers and Araki and Woods which served as starting point for the work of Connes [?, ?], the work of Jones [?], and other leading figures in the field. What is may main contribution is fresh physical interpretation of this mathematics which also helps to make mathematical conjectures. The book of Connes [?] available in web provides an excellent overall view about von Neumann algebras and non-commutative geometry.

#### 5.1.1 The recent progress in Quantum TGD and identification of *M*-matrix

My original intention was to summarize the basic principles of Quantum TGD first. The problem is however where to start from since everything is so tightly interwoven that linear representation proceeding from principles to consequences seems impossible. Therefore it might be a good idea to try to give a summary with emphasis on what has happened during the few months in turn of 2008 to 2009 assuming that the reader is familiar with the basic concepts discussed in previous chapters. This summary gives also a bird's eye of view about what I believe *M*-matrix to be. Later this picture is used to answer the questions raised in the earlier version of this chapter.

#### Zero energy ontology

One of the key notions underlying the recent developments is zero energy ontology.

1. Zero energy ontology leads naturally to the identification of light-like 3-surfaces interpreted as a generalization of Feynman diagrams as the most natural dynamical objects (equivalent with space-like 3-surface by holography).
2. The fractal hierarchy of causal diamonds ( $CD$ ) with light like boundaries of  $CD$  interpreted as carriers of positive and negative energy parts of zero energy state emerges naturally. If the scales of  $CD$ s come as powers of 2, p-adic length scale hypothesis follows as a consequence.
3. The identification of  $M$ -matrix as time-like entanglement coefficients between zero energy states identified as the product of positive square root of the density matrix and unitary  $S$ -matrix emerges naturally and leads to the unification of thermodynamics and quantum theory.
4. The identification of  $M$ -matrix in terms of Connes tensor product means that the included algebra  $\mathcal{N} \subset \mathcal{M}$  acts effectively like complex numbers and does not affect the physical state. The interpretation is that  $\mathcal{N}$  corresponds to zero energy states in size scales smaller than the measurement resolution and thus the insertion of this kind of zero energy state should not have any observable effects. The uniqueness of Connes tensor product gives excellent hopes that the  $M$ -matrix could be unique apart from the square root of of density matrix.
5. The unitary  $U$ -matrix between zero energy states assignable to quantum jump has nothing to do with  $S$ -matrix measured in particle physics experiments. A possible interpretation is in terms of consciousness theory. For instance,  $U$ -matrix could make sense even for p-adic-to-real transitions interpreted as transformations of intentions to actions making sense since zero energy state is generated ('Everything is creatable from vacuum' is the basic principle of zero energy ontology) [K42]. One can express  $U$ -matrix as a collection of  $M$ -matrices labeled by zero energy states and unitarity conditions for  $U$ -matrix boil down to orthogonality conditions for the zero energy states defined by  $M$ -matrices.

### The notion of finite measurement resolution

The notion of finite measurement resolution as a basic dynamical principle of quantum TGD might be seen by a philosophically minded reader as the epistemological counterpart of zero energy ontology.

1. As far as length scale resolution is considered, finite measurement resolution implies that only  $CD$ s above some size scale are allowed. This is not an approximation but a property of zero energy state so that zero energy states realize finite measurement resolution in their structure. One might perhaps say that quantum states represent only the information that we can become conscious of.
2. In the case of angle resolution the hierarchy of Planck constants accompanied by a hierarchy of algebraic extensions of rationals by roots of unity, and realized in terms of the book like structures assigned with  $CD$  and  $CP_2$ , is a natural outcome of this thinking.
3. Number theoretic braids implying discretization at parton level can be seen as a space-time correlate for the finite measurement resolution. Zero energy states should contain in their construction only information assignable to the points of the braids. Note however that there is also information about tangent space of space-time surface at these points so that the theory does not reduce to a genuinely discrete theory. Each choice of  $M^2$  and geodesic spheres defines a selection of quantization axis and different choice of the number theoretic braid. Hence discreteness does not reduce to that resulting from the assumption that space-time as the arena of dynamics is discrete but reflects the limits to what we can measure, perceive, and cognize in continuous space-time. Zero energy state corresponds to wave-function in the space of these choices realized as the union of copies of the page  $CD \times CP_2$ . Quantum measurement must induce a localization to single point in this space unless one is ready to take seriously the notion of quantum multiverse.
4. Finite measurement resolution allows a realization in terms of inclusions  $\mathcal{N} \subset \mathcal{M}$  of hyper-finite factors of type  $II_1$  (HFFs) about which the configuration space Clifford algebra provides standard example. Also the factor spaces  $\mathcal{M}/\mathcal{N}$  are suggestive and should correspond to quantum variants of HFFs with a finite quantum dimension. p-Adic coupling constant evolution can be

understood in this framework and corresponds to the inclusions of HFFs realized as inclusions of spaces of zero energy states with two different scale cutoffs.

### Number theoretical compactification and $M^8 - H$ duality

The closely related notions of number theoretical compactification and  $M^8 - H$  duality have had a decisive impact on the understanding of the mathematical structure of quantum TGD.

1. The hypothesis is that TGD allows two equivalent descriptions using either  $M^8$ - the space of hyper-octonions- or  $H = M^4 \times CP_2$  as imbedding space so that standard model symmetries have a number theoretic interpretation. The underlying philosophy is that the world of classical worlds and thus  $H$  is unique so that the symmetries of  $H$  should be something very special. Number theoretical symmetries indeed fulfil this criterion.
2. In  $M^8$  description space-time surfaces decompose to hyper-quaternionic and co-hyperquaternionic regions. The map assigning to  $X^4 \subset M^8$  the image in  $X^4 \subset H$  must be a isometry and also preserve the induced Kähler form so that the Kähler action has same value in the two spaces. The isometry groups of  $E^4$  and  $CP_2$  are different, and the interpretation is that the low energy description of hadrons in terms of  $SO(4)$  symmetry and high energy description in terms of  $SU(3)$  gauge group reflect this duality.
3. Number theoretic compactification implies very detailed conjectures about the preferred extremals of Kähler action implying dual slicings of the  $M^4$  projection of space-time surface to string world sheets  $Y^2$  and partonic 2-surfaces  $X^2$  for Minkowskian signature of induced metric. This occurs for the known extremals of Kähler action of this kind [K9] . These slicings allow to understand how Equivalence Principle emerges via its stringy variant in TGD framework through dimensional reduction. The tangent spaces of  $Y^2$  and  $X^2$  define local planes of physical and un-physical polarizations and  $M^2$  defines also the plane for the four-momentum assignable to the braid strand so that gauge symmetries are purely number theoretical interpretation.
4. Also a slicing of  $X^4(X_l^3)$  to light-like 3-surfaces  $Y_l^3$  parallel to  $X_l^3$  giving equivalent space-time representations of partonic dynamics is predicted. This implies holography meaning an effective reduction of space-like 3-surfaces to 2-D surfaces. Number theoretical compactification leads also to a dramatic progress in the construction of quantum TGD in terms of the second quantized induced spinor fields. The holography seems however to be not quite simple as one might think first. Kac-Moody symmetries respecting the light-likeness of  $X_l^3$  and leaving  $X^2$  fixed act as gauge transformations and all light-like 3-surfaces with fixed ends and related by Kac-Moody symmetries would be geometrically equivalent in the sense that configuration space Kähler metric is identical for them. These transformations would also act as zero modes of Kähler action.
5. A physically attractive realization of the braids - and more generally- of slicings of space-time surface by 3-surfaces and string world sheets, is discussed in [?] by starting from the observation that TGD defines an almost topological QFT of braids, braid cobordisms, and 2-knots. The boundaries of the string world sheets at the space-like 3-surfaces at boundaries of  $CD$ s and wormhole throats would define space-like and time-like braids uniquely.

The idea relies on a rather direct translation of the notions of singular surfaces and surface operators used in gauge theory approach to knots [?] to TGD framework. It leads to the identification of slicing by three-surfaces as that induced by the inverse images of  $r = \text{constant}$  surfaces of  $CP_2$ , where  $r$  is  $U(2)$  invariant radial coordinate of  $CP_2$  playing the role of Higgs field vacuum expectation value in gauge theories.  $r = \infty$  surfaces correspond to geodesic spheres and define analogs of fractionally magnetically charged Dirac strings identifiable as preferred string world sheets. The union of these sheets labelled by subgroups  $U(2) \subset SU(3)$  would define the slicing of space-time surface by string world sheets. The choice of  $U(2)$  relates directly to the choice of quantization axes for color quantum numbers characterizing  $CD$  and would have the choice of braids and string world sheets as a space-time correlate.

### Configuration space spinor structure

The construction of configuration space spinor structure in terms of second quantized induced spinor fields is certainly the most important step made hitherto towards explicit formulas for  $M$ -matrix elements.

1. Number theoretical compactification ( $M^8 - H$  duality) states that space-time surfaces can be equivalently regarded as 4-dimensional surfaces of either  $H = M^4 \times CP_2$  or of 8-D Minkowski space  $M^8$ , and consisting of hyper-quaternionic and co-hyper-quaternionic regions identified as regions with Minkowskian and Euclidian signatures of induced metric. Duality preserves induced metric and Kähler form. This duality poses very strong constraints on the geometry of the preferred extremals of Kähler action implying dual slicings of the space-time surface by string worlds sheets and partonic 2-surfaces as also by light-like 1-surfaces and light-like 3-surfaces. These predictions are consistent what is known about the extremals of Kähler action. The predictions of number theoretical compactification lead to dramatic progress in the construction of configurations space spinor structure and geometry. One consequence is dimensional reduction of space-time surface to string world sheet allowing to understand how the space-time correlate for Equivalence Principle is realized in TGD framework (its quantum counterpart emerges from coset construction for super-symplectic and super Kac-Moody algebras).
2. The construction of configuration space geometry and spinor structure in terms of induced spinor fields leads to the conclusion that finite measurement resolution is an intrinsic property of quantum states basically due to the vacuum degeneracy of Kähler action. This gives a justification for the notion of number theoretic braid effectively replacing light-like 3-surfaces. Hence the infinite-dimensional configuration space is replaced with a finite-dimensional space  $(\delta M_{\pm}^4 \times CP_2)^n / S_n$ . A possible interpretation is that the finite fermionic oscillator algebra for given partonic 2-surface  $X^2$  represents the factor space  $\mathcal{M}/\mathcal{N}$  identifiable as quantum variant of Clifford algebra.  $(\delta M_{\pm}^4 \times CP_2)^n / S_n$  would represent its bosonic analog.
3. The isometries of the configuration space corresponds to  $X^2$  local symplectic transformations  $\delta M_{\pm}^4 \times CP_2$  depending only on the value of the invariant  $\epsilon^{\mu\nu} J_{\mu\nu}$ , where  $J_{\mu\nu}$  can correspond to the Kähler form induced from  $\delta M_{\pm}^4$  or  $CP_2$ . This group parameterizes quantum fluctuating degrees of freedom. Zero modes correspond to coordinates which cannot be made complex, in particular to the values of the induced symplectic form which thus behaves as a classical field so that configuration space allows a slicing by the classical field patterns  $J_{\mu\nu}(x)$  representing zero modes.
4. By the effective 2-dimensionality of light-like 3-surfaces  $X_l^3$  (holography) the interiors of light-like 3-surfaces are analogous to gauge degrees of freedom and partially parameterized by Kac-Moody group respecting the light-likeness of 3-surfaces. Quantum classical correspondence suggests that gauge fixing in Kac-Moody degrees of freedom takes place and implies correlation between the quantum numbers of the physical state and  $X_l^3$  or equivalently any light-like 3-surface  $Y_l^3$  parallel to  $X_l^3$ . There would be no path integral over  $X_l^3$  and only functional integral defined by configuration space geometry over partonic 2-surfaces.
5. The condition that the Noether currents assignable to the modified Dirac equation are conserved requires that space-time surfaces correspond to extremals for which second variation of Kähler action vanishes. A milder condition is that the rank of the matrix defined by the second variation of Kähler action is less than maximal. Preferred extremals of Kähler action can be identified as this kind of 4-surface and the interpretation is in terms of quantum criticality.
6. The inverse of the modified Dirac operator does not define stringy propagator since it does not depend on the quantum numbers of the state of super-conformal representation. The solution of the problem is provided by the addition of measurement interaction term to the modified Dirac action and assignable to wormhole throats or equivalently any light-like 3-surface parallel to them into the slicing of space-time sheet: this condition defines additional symmetry modifying Kähler function and Kähler action in such a manner that Kähler metric is not affected. Measurement interaction term implies that the preferred extremals of Kähler action depend on quantum numbers of the states of super-conformal representations as quantum classical correspondence

requires. The coupling constants appearing in the measurement interaction term are fixed by the condition that Kähler function transforms only by a real part of a holomorphic function of complex coordinates of WCW depending also on zero modes so that Kähler metric of WCW remains unchanged. This realizes also the effective 2-dimensionality of space-like 3-surfaces but only in finite regions where the slicing by light-like 3-surfaces makes sense.

### Hierarchy of Planck constants

The hierarchy of Planck constants realized as a replacement of  $CD$  and  $CP_2$  of  $CD \times CP_2$  with book like structures labeled by finite subgroups of  $SU(2)$  assignable to Jones inclusions is now relatively well understood as also its connection to dark matter, charge fractionization, and anyons [K25, ?].

1. This notion leads also to a unique identification of number theoretical braids as intersections of  $CD$  ( $CP_2$ ) projection of  $X_l^3$  and the back  $M^2$  (the backs  $S_I^2$  and  $S_{II}^2$ ) of  $M^4$  ( $CP_2$ ) book. The spheres  $S_I^2$  and  $S_{II}^2$  are geodesic spheres of  $CP_2$  orthogonal to each other).
2. The formulation of  $M$ -matrix should involve the local data from the points of number theoretic braids at partonic 2-surfaces. This data involves information about tangent space of  $X^4(X^3)$  so that the theory does not reduce to 2-D theory. The hierarchy of  $CD$ s within  $CD$ s means that the improvement of measurement resolution brings in new  $CD$ s with smaller size.
3. The points of number theoretical braids are by definition quantum critical with respect to the phase transitions changing Planck constant and meaning leakage between different pages of the books in question. This quantum criticality need not be equivalent with the quantum criticality in the sense of the degeneracy of the matrix like entity defined by the second variation of Kähler action. Note that the entire partonic 2-surface at the boundary of  $CD$  cannot be quantum critical unless it corresponds to vacuum state with only topological degrees of freedom excited (that is have as its  $CD$  ( $CP_2$ ) projection at the back of  $CD$  ( $CP_2$ ) book or both) since Planck constant would be ill-defined in this kind of situation.

### Super-conformal symmetries

There have been a considerable progress also in the understanding of super-conformal symmetries [K15, ?].

1. Super Kac-Moody and super-symplectic symmetries correspond to the dual slicings of  $X^4(X_l^3)$  to string world sheets  $Y^2$  and partonic 2-surfaces  $X^2$ . The duality is realized for Super Virasoro algebras in terms of coset construction meaning that the differences of Super Virasoro generators annihilate physical states. The four-momenta assignable to the two representations correspond to gravitational and inertial four-momenta and Equivalence Principle in microscopic form follows.
2. Neither Super Kac-Moody nor super-symplectic Super-Virasoro generators annihilate the states separately and this gives justification for p-adic thermodynamics as thermodynamics of conformal weight with thermal expectation identified as mass squared.
3. A further step of progress relates to the understanding of the fusion rules of symplectic field theory [?]. These fusion rules makes sense only if one allows discretization that is number theoretic braids. An infinite hierarchy of symplectic fusion algebras can be identified with nice number theoretic properties (only roots of unity appear in structure constants). Hence there are good hopes that symplecto-conformal N-point functions defining the vertices of generalized Feynman diagrams can be constructed exactly.
4. The possible reduction of the fermionic Clifford algebra to a finite-dimensional one means that super-conformal algebras must have a cutoff in conformal weights. These algebras must reduce to finite dimensional ones and the replacement of integers with finite field is what comes first in mind.
5. The conserved fermionic currents implied by vanishing second variations of Kähler action for preferred extremal define a hierarchy of super-conformal algebras assignable to zero modes. These currents are appear in the expression of measurement interactions added to the modified

Dirac action in order to obtain stringy propagators and the coding of super-conformal quantum numbers to space-time geometry.

### 5.1.2 Various inputs to the construction of $M$ -matrix

It is perhaps wise to summarize briefly the vision about  $M$ -matrix.

#### Zero energy ontology and interpretation of light-like 3-surfaces as generalized Feynman diagrams

1. Zero energy ontology is the cornerstone of the construction. Zero energy states have vanishing net quantum numbers and consist of positive and negative energy parts, which can be thought of as being localized at the boundaries of light-like 3-surface  $X_l^3$  connecting the light-like boundaries of a causal diamond  $CD$  identified as intersection of future and past directed light-cones. There is entire hierarchy of  $CD$ s, whose scales are suggested to come as powers of 2. A more general proposal is that prime powers of fundamental size scale are possible and would conform with the most general form of p-adic length scale hypothesis. The hierarchy of size scales assignable to  $CD$ s corresponds to a hierarchy of length scales and code for a hierarchy of radiative corrections to generalized Feynman diagrams.
2. Light-like 3-surfaces are the basic dynamical objects of quantum TGD and have interpretation as generalized Feynman diagrams having light-like 3-surfaces as lines glued together along their ends defining vertices as 2-surfaces. By effective 2-dimensionality (holography) of light-like 3-surfaces the interiors of light-like 3-surfaces are analogous to gauge degrees of freedom and partially parameterized by Kac-Moody group respecting the light-likeness of 3-surfaces. This picture differs dramatically from that of string models since light-like 3-surfaces replacing stringy diagrams are singular as manifolds whereas 2-surfaces representing vertices are not.

#### Identification of TGD counterpart of $S$ -matrix as time-like entanglement coefficients

1. The TGD counterpart of  $S$ -matrix -call it  $M$ -matrix- defines time-like entanglement coefficients between positive and negative energy parts of zero energy state located at the light-like boundaries of  $CD$ . One can also assign to quantum jump between zero energy states a matrix- call it  $U$ -matrix - which is unitary and assumed to be expressible in terms of  $M$ -matrices.  $M$ -matrix need not be unitary unlike the  $U$ -matrix characterizing the unitary process forming part of quantum jump. There are several good arguments suggesting that that  $M$ -matrix cannot be unitary but can be regarded as thermal  $S$ -matrix so that thermodynamics would become an essential part of quantum theory. In fact,  $M$ -matrix can be decomposed to a product of positive diagonal matrix identifiable as square root of density matrix and unitary matrix so that quantum theory would be kind of square root of thermodynamics. Path integral formalism is given up although functional integral over the 3-surfaces is present.
2. In the general case only thermal  $M$ -matrix defines a normalizable zero energy state so that thermodynamics becomes part of quantum theory. One can assign to  $M$ -matrix a complex parameter whose real part has interpretation as interaction time and imaginary part as the inverse temperature.

#### Hyper-finite factors and $M$ -matrix

HFFs of type  $III_1$  provide a general vision about  $M$ -matrix.

1. The factors of type III allow unique modular automorphism  $\Delta^{it}$  (fixed apart from unitary inner automorphism). This raises the question whether the modular automorphism could be used to define the  $M$ -matrix of quantum TGD. This is not the case as is obvious already from the fact that unitary time evolution is not a sensible concept in zero energy ontology.
2. Concerning the identification of  $M$ -matrix the notion of state as it is used in theory of factors is a more appropriate starting point than the notion modular automorphism but as a generalization of thermodynamical state is certainly not enough for the purposes of quantum TGD and quantum

field theories (algebraic quantum field theorists might disagree!). Zero energy ontology requires that the notion of thermodynamical state should be replaced with its "complex square root" abstracting the idea about M-matrix as a product of positive square root of a diagonal density matrix and a unitary S-matrix. This generalization of thermodynamical state -if it exists- would provide a firm mathematical basis for the notion of M-matrix and for the fuzzy notion of path integral.

3. The existence of the modular automorphisms relies on Tomita-Takesaki theorem, which assumes that the Hilbert space in which HFF acts allows cyclic and separable vector serving as ground state for both HFF and its commutant. The translation to the language of physicists states that the vacuum is a tensor product of two vacua annihilated by annihilation oscillator type algebra elements of HFF and creation operator type algebra elements of its commutant isomorphic to it. Note however that these algebras commute so that the two algebras are not hermitian conjugates of each other. This kind of situation is exactly what emerges in zero energy ontology: the two vacua can be assigned with the positive and negative energy parts of the zero energy states entangled by M-matrix.
4. There exists infinite number of thermodynamical states related by modular automorphisms. This must be true also for their possibly existing "complex square roots". Physically they would correspond to different measurement interactions giving rise to Kähler functions of WCW differing only by a real part of holomorphic function of complex coordinates of WCW and arbitrary function of zero mode coordinates and giving rise to the same Kähler metric of WCW.

### Connes tensor product as a realization of finite measurement resolution

The inclusions  $\mathcal{N} \subset \mathcal{M}$  of factors allow an attractive mathematical description of finite measurement resolution in terms of Connes tensor product but do not fix M-matrix as was the original optimistic belief.

1. In zero energy ontology  $\mathcal{N}$  would create states experimentally indistinguishable from the original one. Therefore  $\mathcal{N}$  takes the role of complex numbers in non-commutative quantum theory. The space  $\mathcal{M}/\mathcal{N}$  would correspond to the operators creating physical states modulo measurement resolution and has typically fractal dimension given as the index of the inclusion. The corresponding spinor spaces have an identification as quantum spaces with non-commutative  $\mathcal{N}$ -valued coordinates.
2. This leads to an elegant description of finite measurement resolution. Suppose that a universal M-matrix describing the situation for an ideal measurement resolution exists as the idea about square root of state encourages to think. Finite measurement resolution forces to replace the probabilities defined by the M-matrix with their  $\mathcal{N}$  "averaged" counterparts. The "averaging" would be in terms of the complex square root of  $\mathcal{N}$ -state and a direct analog of functionally or path integral over the degrees of freedom below measurement resolution defined by (say) length scale cutoff.
3. One can construct also directly M-matrices satisfying the measurement resolution constraint. The condition that  $\mathcal{N}$  acts like complex numbers on M-matrix elements as far as  $\mathcal{N}$ -"averaged" probabilities are considered is satisfied if M-matrix is a tensor product of M-matrix in  $\mathcal{M}(\mathcal{N}$  interpreted as finite-dimensional space with a projection operator to  $\mathcal{N}$ ). The condition that  $\mathcal{N}$  averaging in terms of a complex square root of  $\mathcal{N}$  state produces this kind of M-matrix poses a very strong constraint on M-matrix if it is assumed to be universal (apart from variants corresponding to different measurement interactions).

### Conformal symmetries and stringy diagrammatics

The modified Dirac equation has rich super-conformal symmetries helping to achieve concrete vision about the structure of M-matrix in terms of generalized Feynman diagrammatics

1. Both super-conformal symmetries, the slicing of space-time surface by string worlds sheets, and the reduction of space-time sheet to string world sheet as a consequence of finite measurement

resolution suggest that the generalized Feynman diagrams have as vertices  $N$ -point functions of a conformal field theory assignable to the partonic 2-surfaces at which the lines of Feynman diagram meet. Finite measurement resolution means that this conformal theory is defined in the discrete set defined by the number theoretic braid. The presence of symplectic invariants in turn suggest a symplectic variant of conformal field theory leading to a concrete construction of symplectic fusion rules relying in crucial manner to discretization.

2. The effective 3-dimensionality implied by the modified Dirac operator associated with Kähler action plays crucial role in the construction of both configuration space geometry (Kähler function is identified as Dirac determinant assignable to the modified Dirac operator) and of  $M$ -matrix. By effective 3-dimensionality the propagators reduce to the propagators assignable the light-like 3-surfaces. This does not give stringy propagators and massive stringy excitations would not appear at all in propagators. This does not conform with what p-adic mass calculations and conformal symmetries suggest.
3. The solution of the problem is provided by the already described addition of measurement interaction term to the modified Dirac action and assignable to wormhole throats or equivalently any light-like 3-surface parallel to them into the slicing of space-time sheet: this condition defines additional symmetry.

### TGD as almost topological QFT

The idea that TGD could be regarded as almost topological QFT has been very fruitful although the hypothesis that Chern-Simons term for induced Kähler gauge potential assignable to light-like 3-surfaces identified as regions of space-time where the Euclidian signature of induced metric assignable to the interior or generalized Feynman diagram changes to Minkowskian one turned out to be too strong. The reduction of configuration space and its Clifford algebra to finite dimensional structures due to finite measurement resolution however realizes this idea but in different manner.

1. There is functional integral over the small deformations of Feynman cobordisms corresponding to the maxima of Kähler function which is finite-dimensional if finite measurement resolution is taken into account. Almost topological QFT property of quantum suggests the identification of  $M$ -matrix as a functor from the category of generalized Feynman cobordisms (generalized Feynman diagrams) to the category of operators mapping the Hilbert space of positive energy states to that for negative energy states: these Hilbert spaces are assignable to partonic 2-surfaces.
2. The limit at which momenta vanish is well-defined for  $M$ -matrix since the modified Dirac action contains measurement interaction term and at this limit one indeed obtains topological QFT.
3. Almost TQFT property suggests that braiding  $S$ -matrices should have important role in the construction. It is indeed possible to assign the with the lines of the generalized Feynman diagram. The reduction of quantum TGD to topological QFT should occur at quantum criticality with respect to the change of Planck constant since in this situation the  $M$ -matrix should not depend at all on Planck constant. Factoring QFTs in 1+1 dimensions give examples of this kind of theories.

### Bosonic emergence

The construction of QFT limit of quantum TGD based on the notion of bosonic emergence led to the most concrete picture about  $M$ -matrix achieved hitherto.

1. An "almost stringy" fermion propagator arises as one adds to the modified Dirac action a term coupling the charges in a Cartan algebra of the isometry group of  $H = M^4 \times CP_2$  to conserved fermionic currents (there are several of them). Also more general observables allow this kind of coupling and the interpretation in terms of measurement interaction. This term also realizes quantum classical correspondence by feeding information about quantum numbers of partons to the geometry of space-time sheet so that quantum numbers entangle with the geometry of space-time sheet as holography requires. This measurement interaction was the last piece in the



puzzle "What are the basic equations of quantum TGD" and unified several visions about the physics predicted by quantum TGD. "Almost stringy" means that the on mass shell fermions obey stringy mass formulas dictated by super-conformal symmetry but that propagator itself -although it depends on four-momentum- is not the inverse of super-Virasoro generator  $G_0$  as it would be in string models.

2. The identification of bosons as wormhole contacts means that bosonic propagation reduces to a propagation of fermion and antifermion at opposite throats of the wormhole throat. In this framework bosonic n-vertex would correspond to the decay of bosons to fermion-antifermion pairs in the loop. Purely bosonic gauge boson couplings would be generated radiatively from triangle and box diagrams involving only fermion-boson couplings. In particular, bosonic propagator would be generated as a self-energy loop: bosons would propagate by decaying to fermion-antifermion pair and then fusing back to the boson. TGD counterpart for gauge theory dynamics would be emergent and bosonic couplings would have form factors with IR and UV behaviors allowing finiteness of the loops constructed from them since the constraint that virtual fermion pair corresponds to wormhole contact poses strong constraint on virtual momenta of fermion and antifermion.

This picture leads to generalized Feynman rules for M-matrix. The QFT limit based on this picture is able to reproduce the p-adic length scale evolution of various gauge coupling strengths with simple cutoffs on mass squared and hyperbolic angle characterizing the state of fermion in the rest system of virtual boson. The presence of these cutoffs is dictated by geometric picture about loops provided by zero energy ontology. The condition that the bosonic  $N > 3$ -vertices vanish when incoming states are on mass shell gives an infinite number of conditions which could fix the cutoffs uniquely.

### Heuristic picture about generalized Feynman rules

Concerning the understanding of the relationship between HFFs and  $M$ -matrix the basic implications are following.

1. General visions do not allow to provide explicit expressions for M-matrix elements. Therefore one must be humble and try to feed in all understanding about quantum TGD and from the quantum field theoretic picture. In particular, the dependence of  $M$ -matrix on Planck constant should be such that the addition of loop corrections as sub- $CD$ s corresponds to an expansion in powers of  $1/\hbar$  as in quantum field theory whereas for tree diagrams there is no dependence on  $\hbar$ .
2. The vacuum degeneracy of Kähler action and the identification of Kähler function as Dirac determinant strongly suggest that fermionic oscillator operators define what could be interpreted as a finite quantum-dimensional Clifford algebra identifiable as a factor space  $\mathcal{M}/\mathcal{N}$ ,  $\mathcal{N} \subset \mathcal{M}$ . One must be however very cautious since also an alternative option in which excitations of labeled by conformal weight are present cannot be excluded. Finite-dimensionality would mean an enormous simplification, and together with the unique identification of number theoretic braids as orbits of the end points of string world sheets this means that the dynamics is finite-quantum-dimensional conforming with the fact effective finite-dimensionality is the defining property of HFFs. Physical states would realize finite measurement resolution in their structure so that approximation would cease to be an approximation.
3. An interesting question is whether this means that  $M$ -matrix must be replaced with quantum  $M$ -matrix with operator valued matrix elements and whether the probabilities should be determined by taking traces of these operators having interpretation as averaging over  $\mathcal{N}$  defining the degrees of freedom below measurement resolution. This kind of picture would conform with the basic properties of HFFs.
4. To the strands of number theoretic braids one would attach fermionic propagators. Since bosons correspond to fermion pairs at the throats of wormhole contact, all propagators reduce to fermionic ones. As found, the addition of measurement interaction term fixes fermionic propagator completely and gives it a stringy character.

5. Similar correlation function in configuration space degrees of freedom would be given in lowest order -and perhaps exact - approximation in terms of the contravariant metric of the configuration space proportional to  $g_K^2$ . Besides this the exponent of Kähler action would be involved. For elementary particles it would be the exponent of Kähler action for  $CP_2$  type vacuum extremal. In this manner something combinatorially very similar to standard perturbation theory would result and there are excellent hopes that p-adic coupling constant evolution in powers of 2 is consistent with the standard coupling constant evolution.
6. Vertices correspond to n-point functions. The contribution depending on fermionic fields defines the quantum number dependent part of the vertices and comes from the fermion field and their conjugates attached to the ends of propagator lines identified as braid strands. Besides this there is a symplecto-conformal contribution to the vertex.

### The expansion of $M$ -matrix in powers of $\hbar$

One should understand how the proportionality of gauge couplings to  $g_K^2$  emerges and how loops give rise to powers of  $\alpha_K$ . In zero energy ontology one does not calculate  $M$ -matrix but tries to construct zero energy state in the hope that QFT wisdom yields cold help to construct Connes tensor product correctly.

1. The basic rule of quantum field theory is that each loop gives  $\alpha = g^2/4\pi$  and thus  $1/\hbar$  factor whereas in tree diagrams only  $g^2$  appears so that they correspond to the semiclassical approximation.
2. This rule is obtained if one assumes loops correspond to a hierarchy of sub- $CD$ s and that in loop one can distinguish one line as "base line" and other lines as radiative corrections. To each internal line one must assign the factor  $r^{-1/2} = (\hbar_0/\hbar)^{1/2}$  and factor  $g_K^2$  except to the portion of base line appearing in loop since otherwise double counting would result. This dictates the expansion of  $M$ -matrix in powers of  $r^{-1/2}$ . It would not be too surprising to have this kind of expansion.
3.  $g_K^2$  factor comes from the functional integral over the partonic 2-surface selected by stationary phase approximation using the exponent of Kähler action. The functional integral over the configuration space degrees of freedom is carried out using contravariant Kähler metric as a propagator and this gives  $g_K^2$  factor in the lowest non-trivial order since one must develop a perturbation theory with respect to the deformations at the partonic 2-surfaces at the ends of line. If the analogs of radiative corrections to this functional integral vanish -as suggested by quantum criticality and required by number theoretic universality - the resulting dependence on  $g_K^2$  is exact and completely analogous to the free field theory propagator. The numerical factors give the appropriate gauge coupling squared.
4. Besides this one must assign to the ends of the propagator line positive and negative energy parts of quantum state representing the particle in question. These give a contribution which is zeroth order in  $\hbar$ . For instance, gauge bosons correspond to fermionic bilinears. Essentially fermion currents formed from spinor fields at the two light-like wormhole throats of the wormhole contact at which the signature of the induced metric changes are in question. Correct dimension requires the presence of  $1/\hbar$  factor in boson state and  $1/\sqrt{\hbar}$  factor in fermion state. The correlators between fermionic fields at the end points of the line are proportional to  $\hbar$  so that normalization factors cancel the  $\hbar$  dependence. Besides this one would expect N-points function of symplecto-conformal QFT with  $N = N_{in} + N_{out}$  having no dependence on  $\hbar$ .

### 5.1.3 Topics of the chapter

The goal is to sketch an overall view about the ideas which have led to the recent view about the construction of  $M$ -matrix. First the basic philosophical ideas are discussed. These include the basic ideas behind TGD inspired theory of consciousness [K74], the identification of p-adic physics as physics of cognition and intentionality forcing the central idea of number theoretic universality, quantum classical correspondence, and the crucial notion of zero energy ontology.

## 5.2 Basic philosophical ideas

The ontology of quantum TGD differs dramatically from that of standard quantum field theories and these differences play a key role in the proposed approach to the construction of  $M$ -matrix.

### 5.2.1 Zero energy ontology

Zero energy ontology has changed profoundly the views about the construction of  $S$ -matrix and forced to introduce the separate notions of  $M$ -matrix and  $U$ -matrix.  $M$ -matrix generalizes the notion of  $S$ -matrix as used in particle physics. The unitary  $U$ -matrix is something new having a natural place in TGD inspired theory of consciousness. Therefore it is best to begin the discussion with a brief summary of zero energy ontology.

#### Motivations for zero energy ontology

Zero energy ontology was first forced by the finding that the imbeddings of Robertson-Walker cosmologies to  $M^4 \times CP_2$  are vacuum extremals. The interpretation is that positive and negative energy parts of states compensate each other so that all quantum states have vanishing net quantum numbers. One can however assign to state quantum numbers as those of the positive energy part of the state. At space-time level zero energy state can be visualized as having positive energy part in geometric past and negative energy part in geometric future. In time scales shorter than the temporal distance between states positive energy ontology works. In longer time scales the state is analogous to a quantum fluctuation.

Zero energy ontology gives rise to a profound distinction between TGD and standard QFT. Physical states are identified as states with vanishing net quantum numbers, in particular energy. Everything is creatable from vacuum - and one could add- by intentional action so that zero energy ontology is profoundly Eastern. Positive *resp.* negative energy parts of states can be identified as states associated with 2-D partonic surfaces at the boundaries of future *resp.* past directed light-cones, whose tips correspond to the arguments of  $n$ -point functions. Each incoming/outgoing particle would define a mini-cosmology corresponding to not so big bang/crunch. If the time scale of perception is much shorter than time interval between positive and zero energy states, the ontology looks like the Western positive energy ontology. Bras and kets correspond naturally to the positive and negative energy states and phase conjugation for laser photons making them indeed something which seems to travel in opposite time direction is counterpart for bra-ket duality.

#### The notions of $U$ -matrix and $M$ -matrix

Zero energy ontology implies two kinds of matrices relevant for physics:  $U$ - and  $M$ .  $U$ -matrix characterizes the unitary process associated with the quantum jump and is universal.  $M$ -matrix has interpretation in terms of time-like entanglement coefficients between positive and negative energy parts of zero energy state and seems to characterize quantum states rather than the universal quantum dynamics. Unitarity conditions can be weakened so that thermodynamic becomes part of quantum theory in the sense that  $M$ -matrix is expressible as a product of positive square root of density matrix and unitary  $S$ -matrix analogous to thermal  $S$ -matrix assignable formally to a complex time parameter.  $U$ - and  $M$ -matrix differ in many respects.

1.  $M$ -matrix defines entanglement between positive and negative energy parts of zero energy state. This entanglement does not make sense between different number fields since the light-like 3-surface defining Feynmann cobordism connecting  $p$ -adic and real partonic 2-surfaces at boundaries of  $CD$  does not make sense. Hence  $M$ -matrix is diagonal with respect to number field.
2. If algebraic universality is accepted in its strongest form,  $U$ -matrix elements must be algebraic numbers so that in zero energy ontology  $U$ -matrix between zero energy states can have elements between different number fields. Note that the vanishing of conserved quantum numbers is absolutely essential for this. This suggests a description of intentional action as  $p$ -adic-to-real transitions in terms of  $U$ -matrix. Algebraic Universality in this sense might be too strong a condition since it becomes questionable whether one can speak at all about real and  $p$ -adic physics as distinct disciplines. A weaker form of number theoretic universality is that the real

and p-adic Universes relate to the algebraic Universes based on algebraic extensions of rationals in the same manner as reals and p-adic number fields and their extensions relate to rationals and algebraics. Also in this case transitions are possible but only between the states which live in rational or algebraic sub-Universes. One might say that real and p-adic universes are like pages of a book and algebraic universes are like the back of the book making it possible for zero energy states to leak between the pages.

3. Both options makes possible to assign  $U$ -matrix to quantum jumps transforming intention to action. The original hypothesis motivated by the stability of sensorily perceived world was that  $U$ -matrix is almost trivial but there is actually no need for this assumption. The stability of sensory perception can be understood if the ensembles formed by  $CD$ s in various scales are nearly thermal so that sensory experience which involves statistical averaging and becomes stable.
4. From the point of view of consciousness theory the natural statement is that  $M$ -matrix corresponds to the passive aspects of conscious experience, that is perception which reduces to quantum measurement and state function reduction at the fundamental level.  $U$ -matrix would in turn correspond to active aspects of conscious experience, including volitional acts and transformations of intentions to actions.

### 2. How $U$ - and $M$ -matrices relate to each other?

The obvious objection against zero energy ontology is that the universality of  $S$ -matrix in the sense of particle physics is lost since  $M$ -matrix characterizes the time-like entanglement of zero energy state and seems therefore to be highly state dependent. It would seem that one must give up the greatest dream of theoretician. The situation is not so bad.

1. The notion of measurement resolution realized in terms of Jones inclusions requires that the included sub-factor  $\mathcal{N} \subset \mathcal{M}$  representing the degrees of freedom below measurement resolution acts effectively like complex numbers on positive and negative energy parts of the zero energy state. This requires that time-like entanglement is given in terms of highly unique Connes tensor product.  $M$ -matrix decomposes to a product of the positive square root of density matrix and unitary  $S$ -matrix and one might hope that  $S$ -matrix is essentially unique for  $CD$  with a given scale.
2. There might be also a connection between  $M$ -matrix and universal  $U$ -matrix.  $U$ -matrix between zero energy states could reduce to a tensor product of possibly universal  $S$ -matrix and its Hermitian conjugate associated with  $M$ -matrices: the first one between positive energy parts and second one between negative energy parts of zero energy states in question. If this is the case, the same  $S$ -matrix would apply both  $U$ -process and state function reduction. One might argue that this connection is necessary since without it there would be no manner to deduce any information about  $U$ -matrix experimentally. Note that density matrix part of  $M$ -matrix can be unit matrix only for hyper-finite factors of type  $II_1$  are in question since only in this case the trace of  $S^\dagger S = Id$  equals to 1 as the normalization of zero energy states requires.
3.  $M$ -matrices associated with different size scales for  $CD$ s coming as powers of two would also have a natural fractal structure. The matrices associated with two  $CD$ s would differ only by the effects caused by p-adic coupling constant evolution. Two subsequent  $M$ -matrices in the hierarchy would differ only by the effects caused by a change in measurement resolution (the scales defining smallest sub- $CD$ s contributing to the calculation of  $M$  would be different). The infinite sequence of Jones inclusions for hyperfinite type  $II_1$  factors isomorphic as von Neumann algebras could express this fractal character algebraically.

### The relationship between $U$ -matrix and $M$ -matrix

The following represents the latest result concerning the relationship between the notions of  $U$ -matrix and  $M$ -matrix and probably provides answer to some of the questions posed in the chapter. What is highly satisfactory that  $U$ -matrix dictates  $M$ -matrix completely via unitarity conditions. A more detailed discussion can be [K42] discussing Negentropy Maximization Principle, which is the basic

dynamical principle of TGD inspired theory of consciousness and states that the information content of conscious experience is maximal.

If the state function reduction associated with time-like entanglement leads always to a product of positive and negative energy states (so that there is no counterpart of bound state entanglement and negentropic entanglement possible for zero energy states: these notions are discussed below)  $U$ -matrix and can be regarded as a collection of  $M$ -matrices

$$U_{m_+n_-,r_+,s_-} = M(m_+,n_-)_{r_+,s_-} \quad (5.2.1)$$

labeled by the pairs  $(m_+,n_-)$  labelling zero energy states assumed to reduced to pairs of positive and negative energy states.  $M$ -matrix element is the counterpart of S-matrix element  $S_{r,s}$  in positive energy ontology. Unitarity conditions for  $U$ -matrix read as

$$\begin{aligned} (UU^\dagger)_{m_+n_-,r_+,s_-} &= \sum_{k_+,l_-} M(m_+,n_-)_{k_+,l_-} \overline{M}(r_+,s_-)_{k_+,l_-} = \delta_{m_+r_+,n_-s_-} \quad , \\ (U^\dagger U)_{m_+n_-,r_+,s_-} &= \sum_{k_+,l_-} \overline{M}(k_+,l_-)_{m_+,n_-} M(k_+,l_-)_{r_+,s_-} = \delta_{m_+r_+,n_-s_-} \quad . \end{aligned} \quad (5.2.2)$$

The conditions state that the zero energy states associated with different labels are orthogonal as zero energy states and also that the zero energy states defined by the dual  $M$ -matrix

$$M^\dagger(m_+,n_-)_{k_+,l_-} \equiv \overline{M}(k_+,l_-)_{m_+,n_-} \quad (5.2.3)$$

-perhaps identifiable as phase conjugate states- define an orthonormal basis of zero energy states.

When time-like binding and negentropic entanglement are allowed also zero energy states with a label not implying a decomposition to a product state are involved with the unitarity condition but this does not affect the situation dramatically. As a matter fact, the situation is mathematically the same as for ordinary S-matrix in the presence of bound states. Here time-like bound states are analogous to space-like bound states and by definition are unable to decay to product states (free states). Negentropic entanglement makes sense only for entanglement probabilities, which are rationals or belong to their algebraic extensions. This is possible in what might be called the intersection of real and p-adic worlds (partonic surfaces in question have representation making sense for both real and p-adic numbers). Number theoretic entropy is obtained by replacing in the Shannon entropy the logarithms of probabilities with the logarithms of their p-adic norms. They satisfy the same defining conditions as ordinary Shannon entropy but can be also negative. One can always find prime  $p$  for which the entropy is maximally negative. The interpretation of negentropic entanglement is in terms of formations of rule or association. Schrödinger cat knows that it is better to not open the bottle: open bottle-dead cat, closed bottle-living cat and negentropic entanglement measures this information.

### How the new ontology relates to the existing world view?

In the new rather Buddhist ontology zero energy states are identified as experienced events and objective reality in the conventional sense becomes only an illusion. Before the new view can be taken seriously one must demonstrate how the illusion about positive energy reality is created and why it is so stable.

#### 1. How the arrow of geometric time emerges?

Before one can consider this question one must have an idea about how the arrow of geometric time emerges in TGD Universe.

1. Conscious entity- self- can be compared to a person sitting in a movie theater with an ability to put the film run in either direction. This person is curious and forces the film to run. Once she has chosen the direction she keeps it as it is since the interesting things are the things not yet known, and are contained by the part of film not yet seen. It might be also easier to run the film in another direction. Translating this to the language of quantum TGD one obtains the following description.

2. Self has as its imbedding space correlate causal diamond  $CD$ , the basic geometric structure of zero energy ontology. The light-like space-time surfaces inside  $CD \times CP_2$  define the basic unit for the "world of classical worlds" (WCW), and one can say that self corresponds to one particular sub-WCW. Geometric time is naturally assigned with  $CD$ .  $CD$  does not move anywhere in the 8-D imbedding space as the standard view about arrow of geometric time would suggest. Rather, self can be compared to the movie theater plus its conscious audience.
3. Self is curious to know what is in the geometric past and future. Since self can induce quantum jumps shifting the quantum superposition of the space-time surfaces to either direction of the geometric time, she does it. Since the contents of consciousness are about the region of space-time surface inside  $CD$  at particular moment of subjective time, correlation between the arrows of subjective time and geometric time results. The experience about the flow of geometric time can be regarded as an illusion analogous to train illusion in which a person sitting in a stationary train has an experience of motion induced by the motion of another train which has begun to move.
4. Once a preferred direction for the arrow is chosen, geometric past corresponds to what is already known and future to the unknown so that the direction of the arrow is stabilized. The  $CP$ -breaking predicted by TGD at fundamental level [K15] might favor a preferred direction for the arrow. The generation of global arrow could involve a competition between selves, and a domino effect in the sense that the arrow for self induces that for sub-selves. Phase conjugate laser beams and self assembly in living matter seem to represent non-standard arrow of geometric time and might have interpretation in terms of local deviations from the standard arrow at some level of the scale hierarchy.
5. One must also understand why the contents of conscious experience seem to represent time=constant snapshot of the universe. Sub- $CD$ s are correlates for sub-selves identified as mental images. They tend to concentrate at near the light-like boundaries of  $CD$ , where the most interesting events are and generate mental images. This explains why the contents of conscious experience of self is about a narrow interval of geometric time rather than the entire 4-volume of  $CD$ .
6. The defender of the standard view might wonder whether the self is forced to sit for all her life in the same movie theater? Does self really correspond to single  $CD$  (sub-WCW) or should one speak about a wave function in the space of  $CD$ s?  $CD$  is partially characterized by the position of the lower tip of  $CD$  in  $H$ . Also the size of  $CD$  matters as well as the choice of quantization axes. In the case of color gauge group  $SU(3)$  the space for choices of quantization axes is flag-manifold, which pops up in a mysterious looking manner in the model of honeybee dance developed by topologist Barbara Shipman [A11]. Could this wave function in the space of sub-WCWs correspond to a kind of wave packet moving in  $H$  so that the direction of geometric time could emerge also in more standard manner? Or could self expand its consciousness by growing -that is by performing quantum jumps in which the size of the  $CD$  characterizing self is scaled up but the lower tip of  $CD$  moves nowhere. Since the scales of  $CD$ s come in powers of 2, this means a testable predictions about the time scales of conscious experience [K67].

## 2. How the stability of perceived reality can be understood?

Consider what the perceived stability of positive energy states, or equivalently that of zero energy states means.

1. What we perceive consciously are time-like state function reductions for events defined by zero energy states. Quantum jumps replace zero energy states with new ones all the subjective time (this corresponds to active aspect of conscious experience) and one can ask whether this makes impossible to experience any stable Universe.
2. Stability under quantum jumps is implied if there are statistical ensembles of  $CD$ s and corresponding zero energy states (fixed to a high degree by Connes tensor product property of time-like entanglement) in various time scales associated with  $CD$ s in  $H$ . Self experiences its sub-selves as mental images and the mental image defined by sub-self corresponds to an ensemble average over sub-selves of sub-self. Hence the stability of experienced world would reflect the

stability of thermal ensemble of events guaranteed by second law of thermodynamics for zero energy states. This allows also to re-interpret the standard trick made in deducing the rates for particle reactions from  $S$ -matrix elements. The problem is that  $|S_{m,n}|^2$  is proportional to a square of delta function expressing energy-momentum conservation. The trick is to interpret second delta function as space-time volume so that one ends up with the replacement of probability for a reaction with probability per four-volume interpreted as a reaction rate per volume. The density of events ( $CDs$ ) per four-volume is the natural interpretation in zero energy ontology.

3. An alternative explanation for the stability of positive energy states is due to that the  $U$ -matrix characterizing quantum jumps between zero energy states is almost trivial. This would mean that the effects of volitional action on zero energy state are very small. The event pairs would be extremely stable once they are generated (how they are generated is an unavoidable question to be addressed below). Infinite sequences of transition between states with same positive energies and same initial energies occur. What is nice that this makes it possible to test the predictions of the theory by experiencing the transition again and again.

### 3. Statistical physics for zero energy states

The statistical physics for zero energy states was already mentioned in the above argument. This need not be equivalent with statistical physics assignable to the zero energy states themselves and defined by the density matrix defined by  $M$ -matrix.

1. It is natural to speak about statistical physics for an ensemble consisting of zero energy states  $|m_+n_-\rangle$  including also their time reversals  $|n_+m_-\rangle$ . In the usual kinetics one deduces equilibrium values for various particle densities as ratios for the rates for transitions  $m_+ \rightarrow n_+$  and their reversals  $n_+ \rightarrow m_+$  so that the densities are given by  $n(n_+)/n(m_+) = \sum_{n_+} \Gamma(m_+ \rightarrow n_+) / \sum_{n_+} \Gamma(n_+ \rightarrow m_+)$ . In the recent situation the same formula can be used to *define* the particle number densities in kinetic equilibrium using the proposed identification of the transition probabilities.
2. Because of the stability of the zero energy states, one can construct many particle systems consisting of zero energy states and can speak about the density of zero energy states per volume. Also the densities  $n_{+,i}$  ( $n_{-,i}$ ) of initial (final) states of given type can be defined and  $n_{+,i}$  can be identified as densities of positive energy states. Also the densities for particles contained by these states can be defined. It would seem that the new ontology can reproduce the standard ontology as something which is not necessary but to which we are accustomed and which does not produce too much harm.
3. The sequence of quantum jumps between zero energy states defines also a sequence between initial (final) states of quantum jump. Ordinary scattering experiment involves the measurement of the quantum numbers of particles in initial and final states. In the zero energy ontology one can perform separate quantum measurements for the observables associated with positive and negative energy components of zero energy states. This measurement would give rise to the scattering event.

### 5. How does the quantum measurement theory generalize?

There are also important questions related to the quantum measurement theory. The zero modes associated with the interior degrees of freedom of space-time surface represent classical observables entangled with partonic observables and this entanglement is reduced in quantum jump. Negentropy Maximization Principle [K42] is the TGD based proposal for the variational principle governing the statistical dynamics of quantum jumps. NMP states that entanglement negentropy tends to be maximized in the reduction of entanglement. Number theoretic variants of Shannon entropy making sense for rationally or even algebraically entangled states can be positive so that NMP can also lead to generation of this kind of entanglement and gives rise to a highly stable bound state entanglement.

### 6. Is the direct creation of zero energy states from vacuum possible?

In principle generation of zero energy states from vacuum is possible. At the first glimpse this option does not seem to be consistent with the assumption that  $U$ -matrix between zero energy states

is induced by  $S$ -matrices between positive and negative energy parts of zero energy states. Should we accept that we are passive spectators who just observe the already existing zero energy states. It seems that this is not necessary.

1. Zero energy states are superpositions of state pairs with different values of conserved quantum numbers which sum up to vanishing net quantum numbers. In particular, zero energy states can contain also a part for which positive and negative energy parts have vanishing quantum numbers. Hence zero energy states can be created also from vacuum for both positive and negative energy parts of the state.
2. There is also a correlation between positive and negative energy parts of the state meaning that also quantum numbers are correlated and conservation laws do not apply locally anymore so that zero energy state is creatable from vacuum.
3. One can also ask whether the creation of zero energy state means a creation of entire  $CD$  or activation of  $CD$  from pure vacuum state. Or could it be that the wave function in the degrees of freedom characterizing position, size, and quantization axes characterizing of  $CD$  changes in quantum jump so that the final state wave function becomes non-vanishing in a new region of  $H$ ?

The creation of zero energy states from vacuum might take place also through intentional action.

1. The mechanism generating p-adic zero energy states as representations of intentions would be same as for the creation of genuine zero energy states. As far as quantum numbers are considered there seems to be no problems of principle involved. One can however wonder whether the notion of conserved classical quantities assignable to Kähler action makes sense p-adically since the notion of definite integral is not well-defined p-adically. A way out of the difficulty is that real and p-adic surfaces involved have same functional form in terms of algebraic functions so that real conserved quantities can be interpreted as p-adic ones when they reduce to algebraic numbers.
2. For zero energy states, p-adic-to-real transitions and vice versa are in principle possible and I have in fact proposed a general quantum model for how intentions might be transformed to actions in this manner [K82]. In the second direction the process corresponds to a formation of cognitive representation of a zero energy physical state. The only thing that is required is that the zero energy states in question can be regarded as those possible for some algebraic extension of rationals so that they make sense both in real and p-adic context with appropriate algebraic extension of p-adic numbers.
3. In the degrees of freedom corresponding to configuration space spinors situation is very much like for reals. Rational, and more generally algebraic number based physics applies in both cases. p-Adic space-time sheets however differ dramatically from their real counterparts since they have only rational (algebraic) points in common with real space-time sheets and p-adic transcendentals are infinite as real numbers. The algebraic valued  $U$ -matrix elements for p-adic-to-real transitions can be formulated using n-point functions restricted to these rational points common to matter and mind stuff. If this picture is not terribly wrong, it would be possible to generate zero energy states from vacuum and the construction of quantum computer programs would be basically a long and tedious process involving very many intentional acts.
4. Real-to-p-adic transitions would represent transformation of reality to cognition and would be also possible. The characteristic and perhaps the defining feature of living matter could be its highly developed ability to reconstruct reality by performing p-adic-to-real transitions and their reversals.
5. Here an interesting aspect of the p-adic conservation laws might have some role. p-Adic integration constants are pseudo constants in the sense that a quantity having vanishing (say) time derivative can depend on a finite number of binary digits  $t_n$  of the time coordinate  $t = \sum_n t_n p^n$ . Could one think that quantum jumps can generate from vacuum exact vacuum states as vacuum tensor factors of the configuration space spinor, and that in subsequent quantum jumps p-adic



$U$ -matrix conserving quantum numbers only in p-adic sense transforms this state into a non-trivial zero energy state which then transforms to a real state in intentional action? Note that if conserved quantum numbers are integers they are automatically pseudo constants. p-Adic conservation laws could allow also the p-adic zero energy states to pop up directly from vacuum.

### 5.2.2 The anatomy of the quantum jump

In TGD framework quantum transitions correspond to a quantum jump between two different quantum histories rather than to a non-deterministic behavior of a single quantum history (understood as an evolution of Schrödinger equation). Therefore  $U$ -matrix relates to each other two quantum histories rather than the initial and final states of a single quantum history and this leads to a resolution of the basic paradox of quantum measurement theory.

To understand the philosophy behind the construction of  $U$ -matrix it is useful to notice that in TGD framework there is actually a 'holy trinity' of time developments instead of single time development encountered in ordinary quantum field theories.

1. The classical time development is coded by the preferred extremal of Kähler action inside each causal diamond  $CD$  defining a hierarchy of time scales coming as powers of 2.
2. The unitary "time development" defined by  $U$  associated with each quantum jump

$$\Psi_i \rightarrow U\Psi_i \rightarrow \Psi_f ,$$

and defining  $U$ -matrix. One cannot however assign to the  $U$ -matrix an interpretation as a unitary time-translation operator. There is a hierarchy of time scales associated with  $U$ -matrices.  $U$ -matrices are between zero energy states and do not correspond directly to the  $S$ -matrix of particle physics, which in zero energy ontology corresponds to the matrix  $M$  defining time-like entanglement coefficients between positive and negative energy parts of zero energy state.

3. The time development of subjective experiences by quantum jumps is identified as sequence of moments of consciousness. The value of geometric time associated with a given quantum jump is determined by the space-time locus for the contents of consciousness of the observer. The understanding of psychological time and its arrow and of the dynamics of subjective time development requires the construction of theory of consciousness [K74, ?] . A crucial role is played by zero energy ontology and by the classical non-determinism of Kähler action implying that the non-determinism of quantum jump and hence also the contents of conscious experience can be concentrated into a finite volume of the imbedding space.

#### Unitary process

$U$  is informational "time development" operator, which is unitary like the  $S$ -matrix characterizing the unitary time evolution in standard quantum mechanics.  $U$ -process is however only formally analogous to Schrödinger time evolution of infinite duration since there is *no* real time evolution or translation involved.

Macro-temporal quantum coherence suggests strongly a fractal hierarchy of  $U$ -matrices defined for periods of macro-temporal quantum coherence consisting of sequences of quantum jumps defining selves. The hierarchy of these unitary  $S$ -matrices would not be only an approximation but provide exact descriptions consistent with the limitations of conscious experience. The duration of the macro-temporal quantum coherence would correspond to the time interval defining unitary time development. Also p-adic length scales would define similar hierarchy of  $U$ -matrices. The realization of zero energy ontology in terms of fractal hierarchy of causal diamonds ( $CD$ s) justifies of this expectation since one can assign to each  $CD$   $U$ -process.

#### State function reduction

The selection of quantization axes, the fact that the perceived world looks classical, and the correlation of outcome of measurement with classical observables should have first level explanation if quantum measurement theory is to be more more than ad hoc construct justifying the basic rules.

1. *Imbedding space correlate for the choice of the quantization axes*

The requirement that quantum jump corresponds to a measurement in the sense of quantum field theories implies that each quantum jump involves localization in zero modes which parameterize also the possible choices of the quantization axes. Thus the selection of the quantization axes performed by the Cartesian outsider becomes a part of quantum theory.

If one takes seriously the proposed hierarchy of Planck constants and the generalization of the imbedding space to a book like structure implied by it, the selection of quantization axes has also imbedding space correlate which means also breaking of fundamental symmetries at the level of given  $CD$  since quantization axes define physically preferred directions. Each  $CD$  would be replaced by a union of its copies with different selection of quantization axes to guarantee symmetries at fundamental level and quantum jump would involve localization to single choice unless one is willing to accept multi-verse picture for conscious experience.

2. *The outcome of the state function reduction must look classical*

Quantum classical correlation requires that quantum states have classical correlates. This means that the final states of quantum jump correspond to quantum superpositions of 3-surfaces which are macroscopically equivalent so that the world of conscious experience looks classical. "Macroscopically equivalent" translates "indistinguishable in the measurement resolution available" in the recent formulation of quantum TGD.

The finiteness of the measurement resolution is a precise quantitative prediction of quantum TGD proper in its recent form and essentially due to the vacuum degeneracy of Kähler actions responsible also for the classical non-determinism. The point is that the induced spinor fields allow only finite number of zero modes for given light-like 3-surface so that anti-commutation relations can be satisfied for a finite set of points only identified as intersection of partonic 2-surface and number theoretic braid. The resulting effective discretization is much more than one might have expected but emerges very naturally in terms of zero energy ontology. The inclusions of hyper-finite factors of type  $II_1$  (HFFs) allow a mathematical formulation of this picture in terms of quantum counterparts of configuration space Clifford algebras.

A way out of the problems caused by the lack of appropriate p-adic integration measure could be that p-adic configuration space spinor fields are localized to discrete subsets of the p-adic configuration space. Finite measurement resolution realized in terms of number theoretic braids implies that not only effective configuration space Clifford algebra has finite quantum dimension but also the effective configuration space itself. Vacuum functional identified as the exponent of Kähler function can be defined in terms of eigenvalues of the modified Dirac operator also in p-adic context and one can consider the possibility that these eigenvalues serve as coordinates for the p-adic configuration space and p-adic configuration space spinor fields are localized to discrete subsets of this space. Much depends also on the representation of 3-surfaces. For instance, the representation in terms of polynomials means that the coefficients of polynomials with some additional algebraic conditions characterize the point of the p-adic configuration space and one can forget the surface itself. Algebraization in terms of quantum coordinates for p-adic configuration space might also help.

### State preparation

TGD inspired theory of consciousness inspires the hypothesis that the standard quantum measurement is followed by a self measurement inside self, which reduces entanglement between some subsystem and its complement in quantum fluctuating degrees of freedom. Again a measurement of the density matrix is in question. Self measurements are repeated until a completely unentangled (within measurement resolution) product state of self results: the process is equivalent with the state preparation process, which is a purely phenomenological part of standard quantum measurement theory. In well defined sense state preparation corresponds to an analysis or decay process respecting only bound state entanglement.

The dynamics of self measurement is governed by Negentropy Maximization Principle (NMP, [K42]), which specifies which subsystems are subject to quantum measurement in a given quantum jump. NMP can be regarded as a basic law for the dynamics of quantum jumps and states that the information content of conscious experience is maximized. In p-adic context NMP would dictate the dynamics of cognition. In real context, self measurement makes possible for the system to fight against thermalization by self-repair at quantum level, and might be a crucial additional element besides the

many-sheeted space-time concept needed to understand how bio-systems manage to be macroscopic quantum systems.

The hypothesis that bound state entanglement coefficients are in the hierarchy of extensions of rational numbers allows to use number theoretic definition of entanglement entropy. This allows to have also negative entropies and in this case NMP does not imply the reduction of entanglement in quantum jump so that there is no need to separately postulate the bound state entanglement is stable against NMP.

### Classical space-time correlates for the basic steps of quantum jump

The classical space-time correlates for the basic notions of quantum measurement theory should be of crucial help in the construction of the  $M$ -matrix. The natural first expectation is that these correlates are encountered only at the level of space-time surfaces. Zero energy ontology and the generalization of the imbedding space forced by the hierarchy of Planck constants led to the conclusion that this kind of correlates emerge also at the level of imbedding space.  $CD$ s serve as correlates for selves and the fractal hierarchy of  $CD$ s allows to characterize finite measurement resolution and treat also the implications of the non-determinism of Kähler action.

#### 1. Correlates at the level of space-time

Consider first space-time correlates for the basic steps of the quantum jump.

1. Space-time sheets correspond to coherence regions for various classical fields obtained by inducing various geometric structures of the imbedding space to the space-time surface. They correspond also to the coherence regions of the induced spinor fields. The classical non-determinism of Kähler action and of corresponding super-symmetrically related Dirac equation makes possible to have space-time correlates for the non-determinism of quantum jump sequence leading to de-coherence. One must be however cautious with what one really means with this notion.
  - (a) The first guess is that de-coherence at space-time level means simply the decomposition of a space-like 3-surface into pieces during its evolution: emission of on mass shell photon by charged elementary particle is the simplest possible example here. Non-determinism must be involved in an essential manner.
  - (b) At particle level  $M$ -matrices are associated with light-like 3-surfaces connecting the light-like boundaries of  $CD$  and representing generalized Feynman diagram with vertices identified as partonic 2-surfaces along with the lines represented by light-like 3-surfaces are glued together. At vertices 3-surfaces and also space-time surfaces are literally branched. State function reduction happens for the zero energy state assignable to this Feynman diagram like 3-surface. In this picture the coherence regions would correspond to connected parts of light-like 3-surfaces and the scale of the smallest  $CD$  in the hierarchy would characterize coherence length and time. De-coherence could be seen as the presence of sub- $CD$ s and corresponding non-deterministic details of space-time surface which serve as a correlate for non-determinism of quantum jumps. At the level of  $M$ -matrix sub- $CD$ s can be assigned to loop corrections in powers of  $\hbar$ .
2. As already explained, the classical non-determinism of the Kähler action allows to represent state function reduction at classical level via stationary phase approximation. Double slit experiment serves as a good example of what could happen.
  - (a) Before the decision to measure which slit the particle propagates through, the space-time surface representing the particle is branched (in the sense of string diagram rather than Feynman diagram) to two parts going through the slits and both branches contain classical spinor field.
  - (b) As the decision is made, p-adic space-time sheet representing the intention to make the measurement is transformed in quantum jump to real space-time sheets, most naturally negative energy topological light rays propagating to the geometric past and interacting with the spinor field and in such a manner that spinor field propagates only along the second branch of the space-time sheet.

- (c) This is achieved if the interaction of negative energy topological light ray transforms space-time sheet to vacuum extremal for which also spinorial energy momentum tensor and various currents vanish identically. Presumably the absorption of negative energy nullifies the energy otherwise propagating along the branch in question. Conservation of various currents implies that the total probability defined by the spinor field goes to the second space-time branch.
3. Also state preparation and NMP should have space-time correlate.
- (a) During state preparation process generation of de-coherence continues and involves maximal de-entanglement in quantum fluctuating degrees of freedom with the formation of bound states being exception. If join along boundaries bonds (realized in terms of magnetic flux tubes say) serve as correlates for the entanglement, the process should correspond at space-time level to the splitting of join along boundaries bonds connecting 3-sheets. 3-surface would quite literally decompose into pieces.
  - (b) Negentropy maximization should thus imply a non-deterministic splitting of 3-surface into pieces if standard expression for entanglement entropy is used. Generation of sub- $CD$ :s would be equivalent correlate.
  - (c) If number theoretic variant of entanglement entropy is allow NMP could force formation of join along boundaries bonds. In [?] I have considered the possibility that Kähler action indeed has an information theoretic interpretation. The non-determinism of NMP would have as a space-time correlate the non-determinism of Kähler action.

### The three non-determinisms

Besides the non-determinism of quantum jump, TGD allows two other kinds of non-determinisms: the classical non-determinism basically due the vacuum degeneracy of the Kähler action and p-adic non-determinism of p-adic differential equations due to the fact that functions with vanishing p-adic derivative correspond to piecewise constant functions.

To achieve classical determinism in a generalized sense, one must generalize the definition of the 3-surfaces  $Y^3$  (belonging to light cone boundary) by allowing also "association sequences", that is 3-surfaces which have, besides the component belonging to the light cone boundary, also disjoint components which do not belong to the light cone boundary and have mutual *time like separations*. This means the introduction of additional, one might hope typically discrete, degrees of freedom (consider non-determinism based on bifurcations as an example). It is even possible to have quantum entanglement between the states corresponding to different values of time.

The explicit quantitative realization of this vision is provided by the fractal hierarchy of  $CD$ s within  $CD$ s. To specify the zero energy state one must characterize it for all  $CD$ s with scale above measurement resolution scale. Finite resolution scale is not an approximation to reality but a basic property of zero energy states forced by the quantization of the induced spinor fields.

Without the classical and p-adic non-determinisms general coordinate invariance would reduce the theory to the light cone boundary and this would mean essentially the loss of time which occurs also in the quantization of general relativity as a consequence of general coordinate invariance. Classical and p-adic non-determinisms imply that one can have quantum jumps with non-determinism (in conventional sense) located to a finite time interval. If quantum jumps correspond to moments of consciousness, and if the contents of consciousness are determined by the locus of the non-determinism, then these quantum jumps must give rise to a conscious experience with contents located in a finite time interval.

Also p-adic space-time sheets obey their own quantum physics and are identifiable as seats of cognitive representations. p-Adic non-determinism might be the basic prerequisite for imagination and simulation.

## 5.3 Zero energy ontology and conformal invariance

In the following some aspects of the role of zero energy ontology and conformal invariance in the construction of  $M$ -matrix are discussed. The emphasis is on the long standing difficulties related to

the realization of the analog of stringy picture about  $M$ -matrix. The general vision that emerged much after the writing the first version of this section is that vertices correspond to  $n$ -point functions of a symplecto-conformal field theory at partonic 2-surfaces. The basic deviation from string models are due to the presence of symplectic  $n$ -point functions (discussed in [?]) and due to the discretization caused by the notion of number theoretic braid. Propagators reduce to fermionic correlators assignable to the lines of the generalized Feynman diagram and the naive expectation supported by QFT like picture and effective 3-dimensionality of space-time is that the inverse of the longitudinal part of the modified Dirac operator  $D_K$ , rather than  $D_K$  itself, is in question. The problem is to understand how the analog of the stringy propagator as inverse of super Virasoro generator  $G$  is obtained. The solution of the problem is that different -one might say fundamental- representation of  $1/G$  determined as the propagator associated with the longitudinal part of  $D_K$  contains a sum over virtual states labeled by integer valued conformal weights rather than only on mass shell state with ground state conformal weight just as the QFT propagator contains sum over virtual momenta.

### 5.3.1 $M$ -matrix as characterizer of time-like entanglement between positive and negative energy components of zero energy state

The idea about giving up the notion of unitary  $S$ -matrix in the standard sense of the word might seem too radical and there is actually no fundamental reason forcing this in the conceptual framework provided by hyper-finite factors of type  $II_1$ . Just the opposite, the freedom to construct zero energy states rather freely could be restricted by the unitarity of the matrix determined by the entanglement coefficients. There are however both mathematical and physical reasons to believe that entanglement coefficients give rise to a thermal  $S$ -matrix which is counterpart of ordinary  $S$ -matrix but for complex time parameter.

Before continuing, it must be added that  $M$ -matrix identified as entanglement coefficients between positive and negative energy parts of zero energy states would characterize zero energy *states* and could be something totally different from the  $U$ -matrix describing unitary process associated with the *quantum jump*. If one however assumes that  $U$ -matrix reduces to a tensor product of  $S$ -matrix parts of  $M$ -matrix and its conjugate between positive energy parts and between negative energy parts of zero energy state, situation changes.

#### Unitarity in zero energy ontology

Quantum classical correspondence combined with the number theoretical view about conformal invariance could fix highly uniquely the dependence of  $M$ -matrix on cm degrees of freedom and on net momenta and color quantum numbers. The corner stone of the interpretation is zero energy ontology applied already earlier in classical TGD.

Unitary  $M$ -matrix is possible for zero energy ontology in case of HFFs of type  $II_1$ . The interpretation of the condition  $Tr(SS^\dagger) = Tr(Id) = 1$  as a normalization condition stimulates the hope that the entanglement between positive and negative energy states in zero energy states is coded by a unitary  $M$ -matrix in the conceptual framework provided by hyper-finite type  $II_1$  factors so that states would represent dynamics in their structure.

It must be however emphasized that unitarity is by no means obvious or necessary in zero energy ontology.

1. What can be measured are basically the ratios of scattering rates since one must always use a clock and clock corresponds to some standard scattering occurring with rate defining the time unit used.
2. If one gives up unitarity and allows the interpretation of  $M^\dagger M$  as density, thermodynamics becomes part of quantum theory. In particular,  $p$ -adic thermodynamics crucial for understanding of particle massivation could emerge in this manner.
3. It is not obvious whether unitarity is even possible in 4-dimensional context. For TQFTs with  $S$ -matrix identified as a functor from category of ordinary cobordisms, unitary  $S$ -matrix is assignable only to trivial cobordisms for  $D < 4$  [?], [?] The situation might be same also for Feynman cobordisms. The whole point of holography is however that space-time is effectively 3-dimensional due to the constraint that virtual states appearing in the lines of Feynman diagram

are only virtual in 3-D sense and correspond to zero modes of the modified Dirac operator in 4-D sense.

4. There is a further strong argument in favor of identification of  $M$ -matrix as the analog of thermal  $S$ -matrix. It is quite possible that HFF of type  $II_1$  is replaced with  $II_\infty$  factor which is a tensor product factors of type  $II_1$  and type  $I$ . In the case of configuration degrees of freedom super-conformal symmetry might guarantee that HFF of type  $II_1$  is in question. Imbedding space degrees of freedom however seem to give rise to factor of type  $I$  via the representations of Poincare group and color partial waves and there seems to be no natural manner to avoid this. Only thermal  $M$ -matrix would define a normalizable state so that thermodynamical states would be genuine quantum states rather than only a useful fiction of theorist.
5. One can hope that  $M$ -matrix as analog of thermal matrix exists for general Feynman cobordisms meaning that thermodynamics and p-adic thermodynamics follow from fundamental principles somewhat like black hole temperature emerges as a property of black hole horizon. Note that for  $U$ -matrix the unitarity is necessary and  $U$ -matrix could be expressed in terms of the  $S$ -matrices associated with  $M$ -matrix.

### Finite measurement resolution and the procedure leading from $M$ -matrix to scattering rates

In standard QFT the procedure leading from from  $S$ -matrix to scattering rates breaks all rules of mathematical aesthetics. The ugliest step in this procedure involves the identification of the 4-dimensional momentum space delta function  $\delta^4(0)$  as a 4-D reaction volume. Encouragingly, zero energy ontology allows to get rid of this feature and also provides a clear physical interpretation for it.

1. In standard positive energy ontology the conservation of energy does not allow localization in time direction so that in time direction the reaction volume is necessarily infinite. In zero energy ontology causal diamonds  $CD$  define naturally finite reaction volumes. If their scales come as powers of 2 -as suggested by the geometry of  $CD$ - one can deduce p-adic length scale hypothesis from this picture in turn supported by the success of p-adic mass calculations. Additional scale hierarchy corresponds to scaled values of Planck constants so that all rational multiples of fundamental scale defined by  $CP_2$  size are in principle possible.
2. p-Adic length scale hierarchy assignable to the hierarchy of  $CD$ s within  $CD$ s is a good candidate for a hierarchy of Jones inclusions with increasing value of  $p$  defining an improved momentum resolution. This leads also to a vision about how p-adic coupling constant evolution for  $M$ -matrix is realized in terms of cutoff characterizing the size of the smallest sub- $CD$  possible.
3. In the framework of zero energy ontology one can say that there is an ensemble of  $CD$ s in  $M^4 \times CP_2$  representing scattering events and reaction rates are obtained by multiplying the density of  $CD$ s with the finite reaction probabilities determined by the  $M$ -matrix. Reaction probabilities are finite since the conservation of four-momentum is a property of states in zero energy ontology and momentum space delta functions can emerge only in the restriction of the four-momentum of positive energy states to a precise value. By the finite size of  $CD$  is is however not possible to make this kind of restriction in zero energy ontology. Only in the idealization that the four-momentum of the initial state is precisely determined the square of  $\delta^4(0)$  would appear and a similar limiting procedure as in the usual case would be needed but would have a clear physical interpretation.
4. Finite length scale resolution suggests at the level of super conformal algebras to a cutoff  $n_{cr}$  for the values of conformal weight and thus mass squared. The finite number of fermionic oscillator operators indeed leads to a cutoff of conformal weight of super-conformal algebras and the replacement of integers with finite field as values of conformal weights is suggestive. The finite truncations of super conformal algebras obtained by replacing the integers  $n$  labeling the states with integers in  $Z/kZ$  would be mathematically natural and define also physically natural Jones inclusions. Prime values of  $k$  would correspond to the replacement of  $Z$  with finite field  $G(k)$ . p-Adic mass calculations suggests that the value of conformal weight for which the mass of the state becomes equal to Hagedorn temperature fixes  $n_{cr}$  and predicts  $n_{cr} \sim \log_2(p)$  [K46]

. Combining this with p-adic length scale hypothesis ( $p \simeq 2^k$ ,  $k$  integer with primes favored) would encourage the hypothesis  $n_{cr} = k$ .

### 5.3.2 Feynman rules in configuration space degrees of freedom

The construction of the theory in fermionic degrees of freedom looks relatively straightforward. In configuration space degrees of freedom the situation seems extremely complicated and I have not been able to find elegant formulation although a reduction to finite-quantum-dimensional configuration space is suggestive, and should reflect the fact that all points of 2-surface except the points of braid are below measurement resolution. The elegant solution could be a formulation in terms of quantize  $M^2$  and  $CP_2$  coordinates allowing to calculate n-point functions and here conformal field theories with string reduced to a discrete set of points representing braid is the most plausible first guess.

#### Configuration space degrees of freedom

Configuration space degrees of freedom can be decomposed to center of mass degrees of freedom, zero modes, and quantum fluctuating degrees of freedom contributing to the configuration space metric including modular degrees of freedom.

1. Cm degrees of freedom correspond to the position of partonic 2-surface, the definition of which should be specified precisely, perhaps as a selection of preferred braid strand. It is not sensible to assign separate four momenta to the braid strands since they are constrained to move parallel.
2.  $M$ -matrix should reduce essentially to a Fourier transform of the N-point function assigned to the incoming and outgoing partonic two-surfaces. The decomposition  $M^4 = M^2(x) \times E^2(x)$  implied by number theoretic compactification and known extremals of field equations with Minkowskian signature of the induced metric suggests that four-momentum should be in the plane  $M^2(x)$  so that a correlation between space-time geometry and quantum numbers would result.
3. Quantum field theory analogy would suggest the association of four-momenta to the propagator lines. This can be done by the introduction of Fourier transform of various correlation functions. The restriction inside  $CD$  implies small breaking of momentum conservation also induced by the restriction to the points of braids.
4. There are also center of mass degrees of freedom associated with  $CP_2$  and here color partial waves are necessary. Color partial waves can be assigned with partonic 2-surfaces and propagators should give correlators conserving color quantum numbers.
5. For partonic 2-surface modular degrees of freedom characterizing the conformal equivalence class of 2-surface in the induced metric is expected to be of special importance and TGD based explanation of family replication phenomenon relies on the notion of elementary particle vacuum functional in these degrees of freedom. Therefore the reduction of the partonic 2-surface to a discrete set of points would mean the loss of crucially important information. At least the global data about topology and complex structure of  $X^2$  must be preserved. Elementary particle vacuum functionals in modular degrees of freedom labeling the complex structures of  $X^2$ , or perhaps punctured  $X^2$  would bring in the needed additional structure. Modular spaces have complex structure so that configuration space Kähler metric could be non-trivial in these degrees of freedom. Induced Kähler form is the most important zero mode and excellent candidate for information that should not be lost in discretization.

#### Configuration space functional integral

About configuration space functional integral one make only some general statements.

1. If only braid points are specified, there is a functional integral over a huge number of 2-surfaces meaning sum of perturbative contributions from very large number of partonic 2-surfaces selected as maxima of Kähler function or by stationary phase approximation. This kind of non-perturbative contribution makes it very difficult to understand what is involved so that it seems that some restrictions must be posed. Also all information about crucial vacuum degeneracy of Kähler action would be lost as a non-local information.

2. Induced Kähler form represents perhaps the most fundamental zero modes since it remains invariant under symplectic transformations acting as isometries of the configuration space. Therefore it seems natural to organize configuration space integral in such a manner that each choice of the induced Kähler form represents its own quantized theory and functional integral is only over deformations leaving induced Kähler form invariant.
3. One can ask whether also the induced Kähler form of the light-cone boundary should be kept fixed so that the deformations of the partonic 2-surfaces would leave invariant both the induced areas and magnetic fluxes. The symplectic orbits of the partonic 2-surfaces (and 3-surfaces) would therefore define a slicing of the configuration space with separate quantization for each slice. It is not clear whether this restriction is consistent with conformal field theory picture.
4. The functional integral would be over the symplectic group of  $CP_2$  and over  $M^4$  degrees of freedom -perhaps also in this case over the symplectic group of  $\delta M_+^4$  - a rather well-defined mathematical structure. Symplectic transformations of  $CP_2$  affect only the  $CP_2$  part of the induced metric so that a nice separation of degrees of freedom results and the functional integral can be assigned solely to the gravitational degrees of freedom in accordance with the idea that fundamental quantum fluctuating bosonic degrees of freedom are gravitational.
5. The configuration space integration around a partonic 2-surface for which the Kähler function is maximum (it could be also selected by a stationary phase approximation) should give only tree diagrams with propagator factors proportional to  $g_K^2$  if loop corrections to the configuration space integral vanish. One could hope that there exist preferred  $S^2$  and  $CP_2$  coordinates such that vertex factors involving finite polynomials of  $S^2$  and  $CP_2$  coordinates reduce to a finite number of diagrams just as in free field theory.

### Symplectic QFT

Also the symplectically invariant degrees of freedom must be treated and this leads to the notion of symplectic QFT. The explicit construction of symplectic fusion rules has been discussed in [?]. These rules make sense only as discretized version. Discreteness can be understood also as a manifestation of finite measurement resolution: at this time it is associated with the impossibility to know the induced Kähler form at each point of partonic 2-surface. What one can measure is the Kähler flux associated with a triangle and the density of triangulation determines the measurement accuracy. The discrete set of points associated with the symplectic algebra characterizes the measurement resolution and there is an infinite hierarchy of symplectic fusion algebras corresponding to gradually increasing measurement resolution in classical sense.

An interesting question is whether the symplectic triangulation could be used to represent a hierarchy of cutoffs of super conformal algebras by introducing additional fermionic oscillators at the points of the triangulation. The  $M^4$  coordinates at the points of symplectic triangulation of  $S_i^2$ ,  $i = I, II$  projection and  $CP_2$  coordinates at the points of symplectic triangulation of  $S^2$  could define discrete version of quantized conformal fields. The functional integral over symplectic group would mean integral over symplectic triangulations. Note that  $M^2$  number theoretic braid is trivial as symplectic triangulation.

Fusion algebra structure constants are equal to products of three roots of unity assignable to each point of braid strand. An open question is whether these phase factors should be identified as counterparts of plane waves factors. Momentum conservation would be replaced in this approach by a weaker condition that the product of these factors equals to unity at each vertex.

In the original variant of symplectic triangulation the exact form of triangulation was left free. It would be however nice if symplectic triangulation could be fixed purely physically by the properties of the induced Kähler form since also the number of fermionic oscillator modes and number theoretical braids is fixed by the dynamics of Kähler action.

1. A symplectically invariant manner to fix the nodes of the triangulation could be in terms of extrema of the symplectic invariant  $\epsilon^{\alpha\beta} J_{\alpha\beta}$ . The maxima of the magnitude of Kähler magnetic field are indeed natural observables.
2. It is not clear whether the precise specification of the edges of the triangulation is needed or has any physical meaning. One might consider the possibility of extremizing the fluxes but it



turns out impossible to formulate this in terms of a local variational principle. The situation is analogous to finding an extremum of function in a situation when the extremum happens to be at the end of the interval so that the vanishing of derivative cannot be taken as criterion. In the recent situation one can expect that the extrema correspond to "triangles" for which symplectic area vanishes or to regions inside which  $\epsilon^{\alpha\beta} J_{\alpha\beta}$  has a fixed sign.

### How string model type quantization could emerge from configuration space functional integral?

Conformal invariance suggests that n-point functions of conformal field theory result from the integration over configuration space degrees of freedom. This means quantization of  $M^4$  and  $CP_2$  coordinates. The quantum variant of configuration space is natural if also configuration space degrees of freedom form hyper-finite factor of type II<sub>1</sub> as super-conformal symmetry suggests, and could be realized through quantization of the imbedding space coordinates.

1. There are reasons to expect that the conformal field theory in question is rational. Also number theoretic universality favors this option. The vertex operators of rational conformal field theories are constructible in terms of the vertex operators :  $exp(i\alpha \cdot m)$  : plus factors for internal quantum numbers. The  $M^4$  coordinate  $m$  is quantized using rules of string theory.
2. In the recent case  $\alpha$  could correspond to four-momenta assignable to the internal lines emerging from the partonic 2-surface providing a close correspondence with quantum field theory. The dynamical Kac-Moody symmetry in transversal degrees of freedom indeed suggests that this kind of factors should be included. The transversal plane to which quantized  $m$  would be restricted could be identified as the plane  $E^2$  defined by the decomposition  $M^4 = M^2 \times E^2$  characterizing given  $CD$ . The well-known tachyonity of the ground state ( $\alpha \cdot \alpha = -2$ ) required by vertex operator construction would not be a catastrophe if  $\alpha$  corresponds to transversal four-momentum. The points of braid are arranged along a closed curve in  $X^2$  in string model but in the recent case it is not clear whether the ordering remains intact.
3. The  $M^4$  projections of the points of number theoretic  $M^2$  braid at  $X^2$  can vary along light-like ray. The problem is that the variations in transversal degrees of freedom for the arguments of n-point function of  $M^4$  coordinates vanish. The problem disappears if  $S^2_i \subset CP_2$  braids are also needed.  $M^2$  braids would allow the description of  $CP_2$  quantum fluctuations and  $CP_2$  braids the description of  $M^4$  quantum fluctuations.
4. Also  $CP_2$  coordinates must be quantized and the first guess is  $CP_2$  WZW model in the point set defined by  $M^2$  braid consisting of point at light-like ray and  $M^4$  string model in the point set defined by  $CP_2$  braid. These two models could allow to calculate the n-point functions for  $M^4$  and  $CP_2$  coordinates by performing functional integral over the symplectic group of  $\delta M^4_{\pm} \times CP_2$ .
5. There are also factors coming from  $CP_2$  color partial waves and  $S^2 \times CP_2$  Hamiltonians depending of center of mass coordinates. The quantized  $M^4$  coordinates would contain these degrees of freedom as center of mass term in the representations of rational conformal field as an ordered exponential. Same trick should work for  $CP_2 = SU(3)/U(2)$  coordinates for braid points.

### 5.3.3 Rational conformal field theories and stringy scattering amplitudes

Rational conformal field theories lead to stringy scattering amplitudes as N-point functions so that there are reasons to expect that they emerge from quantum TGD.

#### General assumptions

Let us list first the general assumptions leading to stringy scattering amplitudes.

1. Quantum criticality of TGD would suggest that, as far as conformal invariance is considered, all details about the microscopic dynamics can be forgotten and the amplitudes for the generation of zero energy states from vacuum can be expressed as vacuum expectation values of the products of primary fields of a rational conformal field theory at partonic 2-surfaces. The primary fields

in question do not directly correspond to the  $M^4$  local versions of fundamental super-conformal algebras creating states at the intersections of partonic causal determinants with  $\delta M_+^4 \times CP_2$ . Rather, they would describe the states created by these operators and possessing conformal weights consistent with rationality. Hence one can completely forget the detailed anatomy of these states and only the values of  $c$  and  $\alpha = \Delta_{mn}$  matters.

2. Since the conformal weights of primary fields are non-negative, mass squared identified as conformal weight using  $CP_2$  mass as unit is non-negative and no problems with tachyons are encountered. The deeper reason for the non-negativity of conformal weights would be that the super-symplectic and Kac-Moody contributions to conformal weight sum up to a non-negative net result. It is important to notice that the vertex operators  $V(z)$  representing Kac-Moody generators used to construct stringy scattering amplitudes have positive conformal weight  $\Delta = mm'$  for  $c \neq 0$  case and, as is clear on basis of Sugawara representation, they would correspond to a negative mass squared in stringy models. This would correspond to the convention  $m^2 = kL_0$ ,  $k < 0$  rather than  $k > 0$ , in TGD framework. It must be added that TGD mass formula is definitely not consistent with that of string models.
3. The first guess is that the expressions for the amplitudes for creating zero energy state generalize as such an could be expressed in terms of the vacuum expectation values of  $n$ -point functions for the primary fields of rational conformal field theories. Stringy form would be obtained by the integration of the arguments over a circle of the partonic 2-surface and by using standard arguments one could fix 3 of the arguments  $z_i$  to  $z = 0, 1, \infty$  in case of sphere. Apart from the normalization constant the resulting amplitude would have the general form

$$A(\alpha_1, \dots, \alpha_n) = \int \prod_{i=4}^n dz^i \langle \phi_{\alpha_1}(0), \phi_{\alpha_2}(1), \phi_{\alpha_3}(\infty) \phi_{\alpha_4}(z_4) \dots \phi_{\alpha_n}(z_n) \rangle ,$$

$$\sum_n \alpha_n = 0 . \quad (5.3.1)$$

Note that the conformal weights of negative energy particles are negative.

### Free field representation of rational conformal field theories gives stringy amplitudes

Rational conformal field theories allow a representation of the primary fields in terms of exponentials of massless free fields  $X(z)$  [?] with the energy momentum tensor

$$T(z) = -\frac{1}{4} : [\partial X(z)]^2 : \quad (5.3.2)$$

The correlation functions of  $X(z)$  and  $\partial X(z)$  are

$$\begin{aligned} \langle X(z)X(\zeta) \rangle &= -2 \log(z - \zeta) , \\ \langle \partial X(z)\partial X(\zeta) \rangle &= -\frac{2}{(z - \zeta)^2} . \end{aligned} \quad (5.3.3)$$

$X(z)$  has the stringy expansion

$$\begin{aligned} X(z) &= \sqrt{2} \left( q - ip \times \log(z) + i \sum \frac{a_n}{n} z^n \right) , \\ [q, p] &= i , \quad [a_n, a_m] = n\delta_{n+m,0} . \end{aligned} \quad (5.3.4)$$

There is of course no need to assume that strings are the underlying dynamical objects and  $z$  corresponds to the complex coordinate of the partonic 2-surface in TGD context.

The normal order exponentials of the free field

$$\begin{aligned}
 V_\alpha(z) &= : \exp(i\alpha X(z)) : \\
 &= \exp(i\sqrt{2}\alpha q) \exp(i\sqrt{2}\alpha p) \exp\left(\sqrt{2}\alpha \sum_{n>0} \frac{a_{-n}}{n} z^n\right) \exp\left(-\sqrt{2}\alpha \sum_{n>0} \frac{a_n}{n} z^n\right) .
 \end{aligned}
 \tag{5.3.5}$$

are also primary fields of conformal weight  $\alpha^2$ . All primary fields of minimal models can be represented in this manner apart from possible factors relating to internal quantum numbers. For  $\alpha^2 = 1$  one obtains representation for the charged generators of ADE type Kac-Moody Lie-algebras in this manner.

The n-point function for these fields can be deduced by using Campbell-Hausdorf formula

$$: \exp(i\alpha X(z)) :: \exp(i\alpha X(\zeta)) := (z - \zeta)^{2\alpha\beta} : \exp(i\alpha X(z) + i\beta X(\zeta)) : ,
 \tag{5.3.6}$$

and is given by

$$\langle V_{\alpha_1}(z_1) V_{\alpha_2}(z_2) \dots \phi_\alpha(z_n) \rangle = \prod_{i<j} (z_i - z_j)^{2\alpha_i\alpha_j}
 \tag{5.3.7}$$

for  $\sum \alpha_i = 0$  and vanishes otherwise. Thus conformal invariance of zero energy states follows from mere internal consistency. Thus rational CFT:s and obviously also ( $c = h = 0$ ) case, would give the basic stringy expression for the amplitudes for creating zero energy states from vacuum.

Consider now whether and how four-momenta could appear in this formula.

1. The number theoretic  $M^4 = M^2 \times E^2$  decomposition and quantum classical correspondence are in accordance with the assignment of Kac-Moody generators with  $E^2$  degrees of freedom. The physical interpretation would be in terms of deformations of partonic 2-surface restricted to  $\delta M_\pm^4$  with one light-like coordinate so that only two degrees of freedom remain since light-like direction corresponds to Super Virasoro symmetries in the construction of configuration space geometry. The generator of Kac-Moody algebra with zero norm would naturally correspond to the light-like direction along  $M_+^4$  for super-symplectic algebra and along light-like partonic surface for Kac-Moody algebra.

One could wonder whether both of these zero norm generators could be included to the extended Dynkin diagram so that twisted affine Lie-algebra would result ( $A_2^{(2)}$ ,  $A_{2l}^{(2)}$  with  $l \geq 2$ ,  $A_{2l-1}^{(2)}$  with  $l \geq 3$ ,  $D_{l+1}^{(2)}$  with  $l \geq 2$ , and  $E_6^{(2)}$  are possible [?]).

2. Suppose therefore that the formula generalizes to 4-D case simply by assigning to each component  $p^k$  of four-momentum its own quantized  $M^4$  coordinate  $X^k$  such that oscillator operator contribution is absent in  $M^2$  degrees of freedom, and requiring  $p^k p_k = \alpha^k \alpha_k = \alpha^2$  in suitable units:  $\alpha^2$  is the conformal weight of the primary field. The identification of the mass squared value as conformal weight would follow automatically using this ansatz. The interpretation would differ from that adopted in string models since only the counterparts of tachyonic scattering amplitudes would be allowed as is indeed natural in zero energy ontology.
3. If  $CP_2$  mass is the unit of quantization the mass unit would be about  $10^{-4}$  Planck masses. This mass scale should apply to the fundamental representations associated with the symmetries of the imbedding spaces. Physical intuition would suggest that p-adic mass squared defines the natural unit of quantization and that hadronic mass squared could be quantized in this manner. This quantization might occur for the secondary Kac-Moody representations defined by ADE series in the case of  $q \neq 1$  Jones inclusions and extended ADE series in the case of  $q = 1$  Jones inclusions suggested in [K25] to occur for large values of  $\hbar$ . The generation of multiplets of ADE quantum groups and ADE Kac Moody algebra could be made possible by the multiple coverings of  $M^4$  defined by the space-time sheets for which points covering given point of  $M^4$  are related by a discrete subgroup of  $G_a \times G_b \subset SL(2, C) \times SU(2)$  (where one has  $SU(2) \subset SU(3)$ ) defining the Jones inclusion. Thus one could say that TGD universal in the sense of being able to represent the quantum dynamics associated with any ADE type quantum group or Kac-Moody group.

### p-Adicization favors rational values for central extension parameter and vacuum conformal weights

p-Adicization strongly suggests that the vacuum conformal weights and central extension parameter are rational numbers. Also algebraic numbers could in principle be considered too: this would not give any conditions if square root allowing algebraic extension of p-adic numbers are used.

#### 1. $N = 0$ case

For ordinary conformal algebra the null states are characterized by the conditions

$$\begin{aligned}\Delta_{mm'} &= \Delta_0 + \frac{1}{4}(\alpha_+ m + \alpha_- m')^2, \quad m, m' \geq 1, \\ N &= mm', \\ \Delta_0 &= \frac{1}{24}(c-1), \\ \alpha_{\pm} &= \frac{\sqrt{1-c} \pm \sqrt{25-c}}{\sqrt{24}}.\end{aligned}\tag{5.3.8}$$

Thus arbitrarily high conformal weights  $N$  are possible in the construction. For  $c \in (1, 25)$  the conformal weights are complex.

For ordinary conformal algebra rationality implies that the ground state conformal weight satisfies

$$\Delta_{mm'} = \frac{(mp' - m'p)^2 - (p' - p)^2}{4pp'}, \quad 0 < m < p, \quad 0 < m' < p'.\tag{5.3.9}$$

A more elegant expression for the central charge and weights reads as

$$\begin{aligned}c &= 1 - \frac{6}{Q(Q+1)}, \\ \Delta_{mm'} &= \frac{1}{4Q(Q+1)} [(Q(m - m' + m)^2 - 1)], \\ Q &= \frac{p}{p' - p}.\end{aligned}\tag{5.3.10}$$

These conditions also imply also that the fusion rules close for a finite number of primary fields in the corresponding conformal field theory.

For  $p' = p+1$  the minimal model is unitary. In this case one has  $Q = p$  is integer  $n \geq 3$ . This range of integers characterizes also the allowed values of quantum phase characterizing Jones inclusions. Furthermore,  $Q$  is related to Kac-Moody central extension in  $SU(2)_k$  theories by  $Q = k + 2$ .

The ground state conformal weight corresponds to  $m = m' = 1$  and vanishes. The null norm state however possesses the conformal weight  $mm' \geq 1$  and is therefore massive. The tachyon of string theories with conformal weight 1 is transformed in TGD framework to the absence of massless states in full accordance with the breaking of conformal invariance.  $Q = p = n$  corresponds naturally to the integer labeling Jones inclusion defining both UV and IR cutoffs with respect to conformal weight. For  $c = 0$  representation without breaking of conformal invariance all states are null norm states and the spectrum contains also massless particles. These representations correspond to  $n = \infty$  case for Jones inclusions and to full Kac-Moody symmetry and ordinary string theory in accordance with the general picture.

Since minimal conformal field theories are in question, the number of primary fields is restricted by the conditions  $0 < m < p$  and  $0 < m' < p' = p + 1$ . By the symmetry  $\Delta_{mm'} = \Delta_{p-m, p'-m'}$ . If corresponding primary fields can be identified, one has  $0 < m < m' < p' (= p + 1)$  and  $0 < m < p$ .

#### 2. Rationality for $N = 1, 2$ super-conformal algebras

The previous considerations apply on Virasoro algebra. These considerations generalize to the case of Kac-Moody algebra and also to corresponding Super algebras. In case of Super Virasoro algebra rationality requirement gives rise to different conditions on the values of  $c$  and  $\Delta_{mn}$  depending in the

value of  $N$ .  $N = 1$  super-conformal algebra corresponds to one real super charge and one real super field and is non-physical in TGD framework.  $N = 2$  case corresponds to single complex super charge and one complex super-field. In this case the Super Virasoro algebra involves also  $U(1)$  Kac-Moody algebra as inherent algebra. If these algebras are important in TGD framework, it would be natural to assign these algebras to quark and lepton type gamma matrices.

The values of the central extension parameter and conformal weights for  $N = 0, 1, 2$  for unitary rational field theories at sphere are summarized by the following table [?].

$$\begin{array}{llll}
 c_k & 1 - \frac{6}{(k+2)(k+3)} & \frac{3}{2} \left( 1 - \frac{8}{(k+2)(k+4)} \right) & 3 \left( 1 - \frac{2}{k+2} \right) \\
 \Delta_{mm'} & \frac{[(k+2)m - (k+1)m']^2 - 1}{4(k+2)(k+3)} & \frac{[(k+4)m - (k+2)m']^2 - 4}{8(k+2)(k+4)} & \frac{m(m+2) - m'^2}{4(k+2)} \\
 & & & (q = \frac{mm'}{k+2}) \\
 m, m' & 1 \leq m \leq k+1 & 1 \leq m \leq k+2 & 0 \leq m \leq k \\
 & 1 \leq m' \leq k+2 & 1 \leq m' \leq k+4 & -m \leq m' \leq m
 \end{array}
 \tag{5.3.11}$$

It must be stressed that the conformal weights assignable to zero energy states are given by  $\Delta_{m,m'} + mm'$  whereas in conformal field theories physical states have conformal weights  $\Delta_{m,m'}$ . For partonic 2-surfaces with handles modular invariance poses additional constraints since primary fields must form a closed set also under modular transformations [?]. In the table above  $q = m'/(k+2)$  corresponds to  $U(1)$  charge.

3. Rationality for  $N = 4$  SCA

Large  $N = 4$  super-conformal symmetry with  $SU(2)_+ \times SU(2)_- \times U(1)$  inherent Kac-Moody symmetry defines the fundamental partonic super-conformal symmetry in TGD framework. In the case of SKM algebra the groups would act on induced spinors with  $SU(2)_+$  representing spin rotations and  $SU(2)_- \times U(1) = U(2)_{ew}$  electro-weak rotations. In super-symplectic sector the action would be geometric:  $SU(2)_+$  would act as rotations on light-cone boundary and  $U(2)$  as color rotations leaving invariant a preferred  $CP_2$  point.

A concise discussion of this symmetry with explicit expressions of commutation and anticommutation relations can be found in [?]. The representations of SCA are characterized by three central extension parameters for Kac-Moody algebras but only two of them are independent and given by

$$\begin{aligned}
 k_{\pm} &\equiv k(SU(2)_{\pm}) , \\
 k_1 &\equiv k(U(1)) = k_+ + k_- .
 \end{aligned}
 \tag{5.3.12}$$

The central extension parameter  $c$  is given as

$$c = \frac{6k_+k_-}{k_+ + k_-} .
 \tag{5.3.13}$$

and is rational valued as required.

A much studied  $N = 4$  SCA corresponds to the special case

$$\begin{aligned}
 k_- &= 1 , \quad k_+ = k + 1 , \quad k_1 = k + 2 , \\
 c &= \frac{6(k+1)}{k+2} .
 \end{aligned}
 \tag{5.3.14}$$

$c = 0$  would correspond to  $k_+ = 0, k_- = 1, k_1 = 1$ . Central extension would be trivial in rotational degrees of freedom but non-trivial in  $U(2)_{ew}$ . For  $k_+ > 0$  one has  $k_1 = k_+ + k_- \neq k_+$ . A possible interpretation is in terms of electro-weak symmetry breaking with  $k_+ > 0$  signalling for the massivation of electro-weak gauge bosons.

A conjecture consistent with the general vision about the quantization of Planck constants is that  $k_+$  and  $k_-$  relate directly to the integers  $n_a$  and  $n_b$  characterizing the values of  $M_{\pm}^4$  and  $CP_2$  Planck

constants via the formulas  $n_a = k_+ + 2$  and  $n_b = k_- + 2$ . This would require  $k_{\pm} \geq 1$  for  $G_i$  a finite subgroup of  $SU(2)$  ("anyonic" phases). In stringy phases with  $G_i = SU(2)$  for  $i = a$  or  $i = b$  or for both,  $k_i$  could also vanish so that also  $n_i = 2$  corresponding to  $A_2$  ADE diagram and  $SU(2)$  Kac-Moody algebra becomes possible. In the super-symplectic sector  $k_+ = 0$  would mean massless gluons and  $k_- = k_1$  that  $U(2) \subset SU(3)$  and possibly entire  $SU(3)$  represents an unbroken symmetry.

### 5.3.4 Objection against zero energy ontology and quantum classical correspondence

The motivation for requiring geometry and topology of space-time as correlates for quantum states is the belief that quantum measurement theory requires the representability of the outcome of quantum measurement in terms of classical physics -and if one believes in geometrization- one ends up with generalization of Einstein's vision.

There is however a counter argument against this view and second one against zero energy ontology in which one assigns eigenstates of four-momentum with causal diamonds ( $CDs$ ).

1. One can argue that momentum eigenstates for which particle regarded as a topological inhomogeneity of space-time surface, which is non-localized cannot allow a space-time correlate.
2. Even worse,  $CDs$  have finite size so that strict four-momentum eigenstates strictly are not possible.

On the other hand, the paradoxical fact is that we are able to perceive momentum eigenstates and they look localized to us. This cannot be understood in the framework of standard Poincare symmetry.

The resolution of the objections and of the apparent paradox could rely on conformal symmetry assignable to light-like 3-surfaces implying a generalization of Poincare symmetry and other symmetries with their Kac-Moody variants for which symmetry transformations become local.

1. Poincare group is replaced by its Kac-Moody variant so that all non-constant translations act as gauge symmetries. Translations which are constant in the interior of  $CD$  and trivial at the boundaries of  $CDs$  are physically equivalent with constant translations. Hence the latter objection can be circumvented.
2. The same argument allows also a localization of momentum eigenstates at the boundaries of  $CD$ . In the interior the state is non-local. Classically the momentum eigenstate assigned with the partonic 2-surface is characterized by its 4-D tangent space data coding for momentum classically. The modified Dirac equation and Kähler action indeed contain an additional term representing coupling to four-momenta of particles. Formally this corresponds only to a gauge transform linear in momentum but Kahler gauge potential has  $U(1)$  gauge symmetry only as a spin glass like degenerate, not as a gauge symmetry so that space-time surface depends on momenta.
3. Conscious observer corresponds in TGD inspired theory of consciousness to  $CD$  and the sensory data of the observer come from partonic 2-surfaces at the boundaries of  $CD$  and its sub- $CDs$ . This implies classicality of sensory experience and momentum eigenstates look classical for conscious perceiver.

The usual argument resolving the paradox is based on the notion of wave packet and also this notion could be involved. The notion of finite measurement resolution is key notion of TGD and it is quite possible that one can require the localization of momentum eigenstates at the boundaries of  $CDs$  only modulo finite measurement resolution for the position of the partonic 2-surfaces.

### 5.3.5 Issues related to Lorentz symmetry

Lorentz invariance fixes the critical dimension of target space in super string models: 26 for bosonic string model and 10 for super-string model. This is strong argument for the claim that super string models have something to do with reality. Also in TGD framework one can ask whether Lorentz symmetric and even more- Poincare symmetric - theory is achieved.

### Evidence for the breaking of Lorentz and color symmetries in TGD framework

There are several reasons suggesting that spontaneous breaking of Poincare symmetries is unavoidable in TGD and has concrete physical meaning in TGD framework.

1. The realization of the hierarchy of Planck constants involves selection of preferred plane  $M^2 \subset M^4$  and geodesic sphere  $S_i^2 \subset CP_2$  implying breaking of Lorentz invariance. The interpretation is that the fixing of quantization axes forces breaking of Poincare and color symmetries at the level of imbedding space.
2. Number theoretical vision implies the hierarchy  $M^2 \subset M^4 \subset M^8$  interpreted as inclusion hierarchy hypercomplex numbers-hyperquaternions-hyper-octonions. Number theoretical compactification is responsible for most of the progress in the understanding of quantum TGD. This hierarchy has also local variant at space-time level and this hierarchy is absolutely essential for  $M^8 - H$  duality. The physical interpretation is in terms of the selection of local polarization plane and plane of four-momentum at space-level. The notion of number theoretic braid can be defined uniquely in terms of  $M^4$  and  $CP_2$  projections of partonic 2-surfaces.
3. One could interpret  $M^4 \rightarrow M^2 \times E^2$  symmetry breaking as a vanishing of the Kac-Moody central charge  $k$  in  $M^2$  factor so that un-broken gauge invariance results. This conforms with the fact that factorizing  $S$ -matrices in  $M^2$  correspond to finite-dimensional representations of loop group. Also the fact that only transversal degrees of freedom are quantum fluctuating degrees of freedom and contribute to configuration space metric correlates with this.
4. An interesting question is whether the breaking of Lorentz symmetry is already encountered in the hadronic scattering in quark model description, which involves the reduction of Lorentz group to  $SO(1,1) \times SO(2)$  corresponding to longitudinal and transverse momenta. The selection of quantization axis in astrophysical length scales together with gigantic value of gravitational Planck constant is an especially fascinating possibility whose implications have been discussed in [K65].

The breaking of fundamental symmetries would not take place at the level of the entire configuration space if the union of copies of  $CD$ s corresponding to different selections of the quantization axes is allowed and configuration space spinor fields are delocalized in the space labeling the choices of quantization axes before the decision to make the experiment. In quantum measurement a localization to fixed  $CD$  would occur unless one wants to believe to multiverse in the sense of conscious experience.

The fact that one can assign to each sector of generalized imbedding space a preferred quantization axis suggests that  $M$ -matrix identified as entanglement coefficients breaks Lorentz symmetry and color symmetry. This symmetry breaking would be interpreted as a space-time correlate for the selection of the Cartan sub-algebra of the isometry group in quantum measurement situation and would thus represent an inherent property of quantum theory, something much deeper than a trouble produced by a gauge choice as in string models. Since the interior degrees of freedom of the space-time sheets correspond to those assignable to the measurement apparatus, the breaking of Lorentz and color symmetries at space-time level would provide a space-time correlate for this symmetry breaking.

There are several instances where the spontaneous symmetry breaking makes itself manifest also at classical level.

1. The possibility to assign almost topological quantum numbers to  $M^4$  and  $CP_2$  degrees of freedom (see the appendix of the book or [K34]) involves a selection of Cartan sub-algebra of the isometry group.
2. A very general solution ansatz for the field equations based on Hamilton-Jacobi coordinates discussed in [K9] involves a local  $M^2 \times E^2$  decomposition of  $M^4$ .
3. The Abelian holonomy for the classical color fields could be interpreted in terms of the reduction of color symmetries to Cartan algebra.

Also momentum space discretization requires breaking of Lorentz invariance. Here however an interesting possibility arises. If only the phase factors defined by plane waves are observable, the explicit breaking of Lorentz and Poincare invariance is avoided. This argument generalizes also to

spin and color quantum numbers since also these correspond to phase factors. Number theoretic universality implies number theoretical variant of Uncertainty Principle in the sense that if plane wave factor is algebraic number then both momentum and position cannot be simultaneously algebraic numbers as required if only algebraic extensions of rationals and  $p$ -adic numbers are allowed. Number theoretic universality allows only roots of unity as possible values of the plane wave phase, which takes the role of observable instead of position or momentum in short scales where the effects of unavoidable discretization are largest. The structure constants of symplectic fusion algebras are products of three phase factors, which are roots of unity and are assigned to the vertices of symplectic triangulation defining arguments of symplectic fields. The interpretation as plane wave factors is suggestive. Note that the 3-dimensionality of 3-space would correlate with the fact that structure constants of symplectic fusion algebra involve three algebra elements.

### Is CPT breaking possible in zero energy ontology?

CPT breaking [?] requires the breaking of Lorentz invariance. Zero energy ontology could therefore allow a spontaneous breaking of CP and CPT. This might imply matter antimatter asymmetry at the level of given  $CD$ .

There is some evidence that the mixing matrices for neutrinos and antineutrinos are different in the experimental situations considered [?, ?]. This would require CPT breaking in the standard QFT framework. In TGD  $p$ -adic length scale hypothesis allowing neutrinos to reside in several  $p$ -adic mass scales. Hence one could have apparent CPT breaking if the measurement arrangements for neutrinos and antineutrinos select different  $p$ -adic length scales for them [K43].

The measurement interaction term of Chern-Simons Dirac action contains a term proportional to four-momentum but this does not imply breaking of CP and CPT since the term involves a contraction of four-momentum with the gradient of  $M^4$  coordinates and is therefore PT even. In standard QFT framework Chern-Simons term breaks CP but in TGD framework one must distinguish between space-time coordinates and imbedding space coordinates. CP breaking occurs at the imbedding space level and instanton term and Chern-Simons term are odd under P and T only at the space-time level and thus distinguish between different orientations of space-time surface.

### Breaking of Lorentz invariance and $N = 4$ super-conformal symmetry

For  $c = 0$  representations of  $N = 4$  SCA critical dimension  $D = 4 + 4$  should guarantee Lorentz invariance: this is indeed expected since the situation corresponds to Jones inclusion with trivial group  $G$ . One cannot however exclude the breaking of the full Lorentz and color symmetries for  $c \neq 0$  representations of  $N = 4$  SCA, which at the level of Jones inclusion means a change of the geometry and topology of the imbedding space and space-time.

The loss of Lorentz invariance would not be a catastrophe since  $M$ -matrix is a property of state rather than that of Universe in TGD framework. As already explained, the interpretation would be in terms of quantum measurement theory selecting a preferred Cartan subgroup for observables. This kind of breaking of course happens in the realistic experimental situation and if state describes also the measurement situation, the breaking is expected. For the scattering of zero energy states Lorentz invariance is obtained in a statistical sense.

This relates interestingly to the claimed uniqueness of super-string model if one requires unitarity and Lorentz invariance. Super string theorists might be right: only 10-D super strings might give rise to a unitary and Lorentz invariant  $S$ -matrix in perturbative sense although the perturbation series does not converge. They might be wrong in their belief that  $S$ -matrix is property of the Universe.

Whether Lorentz invariance is achieved for the stringy  $S$ -matrix characterizing entanglement between positive and negative energy states, depends on the assumptions one is ready to make about states and about what happens in state function reduction. The light cone quantization of string models involves  $M^2 \times E^2$  decomposition interpreted now as a gauge choice and the scattering amplitudes are Lorentz invariant in the critical dimension. Due to the selection of preferred quantization axes the sectors of the configuration space are not Lorentz invariant. If zero energy states are identified as Lorentz invariant superposition of Lorentz transforms of a state in a given sector Lorentz invariance is achieved. Without this assumption it is not clear whether Lorentz invariance is achieved since zero energy ontology implies that the net Poincare quantum numbers assignable to the  $M$ -matrix elements



vanish but does not imply Lorentz invariance. Similar conclusions apply in case of color quantum numbers.

### A light hearted conjecture about relationship to super-strings and M-theory

$N = 4$  topological QFT can be considered as a possible candidate for the theory describing purely topological aspects of quantum TGD quantum criticality with respect to phase transitions changing Planck constant. This is just a guess to be shown wrong. The experience has taught that this kind of conjectures usually wrong: the real progress has come from understanding of TGD itself.

The (4,4) signature characterizing  $N = 4$  SCA topological field theory need not be a problem since in TGD framework the target space becomes a fictive concept defined by the Cartan algebra. Both  $M^4 \times CP_2$  decomposition of the imbedding space and space-time dimension are crucial for the  $2+2+2+2$  structure of the Cartan algebra, which together with the notions of the configuration space and generalized coset representation formed from super Kac-Moody and super-symplectic algebras guarantees  $N = 4$  super-conformal invariance.

Including the 2 gauge degrees of freedom associated with  $M^2$  factor of  $M^4 = M^2 \times E^2$  the critical dimension becomes  $D = 10$  and including the radial degree of light-cone boundary the critical dimension becomes  $D = 11$  of M-theory. Hence the fictive target space associated with the vertex operator construction corresponds to a flat background of super-string theory and flat background of M-theory with one light-like direction. From TGD point view the difficulties of these approaches are due to the un-necessary assumption that the fictive target space defined by the Cartan algebra corresponds to the physical imbedding space. The flatness of the fictive target space forces to introduce the notion of spontaneous compactification and dynamical imbedding space and this in turn leads to the notion of landscape.

## 5.4 Are both symplectic and conformal field theories needed?

Symplectic (or canonical as I have called them) symmetries of  $\delta M_+^4 \times CP_2$  (light-cone boundary briefly) act as isometries of the "world of classical worlds". One can see these symmetries as analogs of Kac-Moody type symmetries with symplectic transformations of  $S^2 \times CP_2$ , where  $S^2$  is  $r_M = \text{constant}$  sphere of lightcone boundary, made local with respect to the light-like radial coordinate  $r_M$  taking the role of complex coordinate. Thus finite-dimensional Lie group  $G$  is replaced with infinite-dimensional group of symplectic transformations. This inspires the question whether a symplectic analog of conformal field theory at  $\delta M_+^4 \times CP_2$  could be relevant for the construction of n-point functions in quantum TGD and what general properties these n-point functions would have. This section appears already in the previous chapter about symmetries of quantum TGD [?] but because the results of the section provide the first concrete construction recipe of  $M$ -matrix in zero energy ontology, it is included also in this chapter.

### 5.4.1 Symplectic QFT at sphere

Actually the notion of symplectic QFT emerged as I tried to understand the properties of cosmic microwave background which comes from the sphere of last scattering which corresponds roughly to the age of  $5 \times 10^5$  years [K50]. In this situation vacuum extremals of Kähler action around almost unique critical Robertson-Walker cosmology imbeddable in  $M^4 \times S^2$ , where there is homologically trivial geodesic sphere of  $CP_2$ . Vacuum extremal property is satisfied for any space-time surface which is surface in  $M^4 \times Y^2$ ,  $Y^2$  a Lagrangian sub-manifold of  $CP_2$  with vanishing induced Kähler form. Symplectic transformations of  $CP_2$  and general coordinate transformations of  $M^4$  are dynamical symmetries of the vacuum extremals so that the idea of symplectic QFT emerges natural. Therefore I shall consider first symplectic QFT at the sphere  $S^2$  of last scattering with temperature fluctuation  $\Delta T/T$  proportional to the fluctuation of the metric component  $g_{aa}$  in Robertson-Walker coordinates.

1. In quantum TGD the symplectic transformation of the light-cone boundary would induce action in the "world of classical worlds" (light-like 3-surfaces). In the recent situation it is convenient to regard perturbations of  $CP_2$  coordinates as fields at the sphere of last scattering (call it  $S^2$ ) so that symplectic transformations of  $CP_2$  would act in the field space whereas those of  $S^2$  would act in the coordinate space just like conformal transformations. The deformation of the metric

would be a symplectic field in  $S^2$ . The symplectic dimension would be induced by the tensor properties of R-W metric in R-W coordinates: every  $S^2$  coordinate index would correspond to one unit of symplectic dimension. The symplectic invariance in  $CP_2$  degrees of freedom is guaranteed if the integration measure over the vacuum deformations is symplectic invariant. This symmetry does not play any role in the sequel.

2. For a symplectic scalar field  $n \geq 3$ -point functions with a vanishing anomalous dimension would be functions of the symplectic invariants defined by the areas of geodesic polygons defined by subsets of the arguments as points of  $S^2$ . Since  $n$ -polygon can be constructed from 3-polygons these invariants can be expressed as sums of the areas of 3-polygons expressible in terms of symplectic form.  $n$ -point functions would be constant if arguments are along geodesic circle since the areas of all sub-polygons would vanish in this case. The decomposition of  $n$ -polygon to 3-polygons brings in mind the decomposition of the  $n$ -point function of conformal field theory to products of 2-point functions by using the fusion algebra of conformal fields (very symbolically  $\Phi_k \Phi_l = c_{kl}^m \Phi_m$ ). This intuition seems to be correct.
3. Fusion rules stating the associativity of the products of fields at different points should generalize. In the recent case it is natural to assume a non-local form of fusion rules given in the case of symplectic scalars by the equation

$$\Phi_k(s_1)\Phi_l(s_2) = \int c_{kl}^m f(A(s_1, s_2, s_3))\Phi_m(s)d\mu_s . \quad (5.4.1)$$

Here the coefficients  $c_{kl}^m$  are constants and  $A(s_1, s_2, s_3)$  is the area of the geodesic triangle of  $S^2$  defined by the symplectic measure and integration is over  $S^2$  with symplectically invariant measure  $d\mu_s$  defined by symplectic form of  $S^2$ . Fusion rules pose powerful conditions on  $n$ -point functions and one can hope that the coefficients are fixed completely.

4. The application of fusion rules gives at the last step an expectation value of 1-point function of the product of the fields involves unit operator term  $\int c_{kl} f(A(s_1, s_2, s))Idd\mu_s$  so that one has

$$\langle \Phi_k(s_1)\Phi_l(s_2) \rangle = \int c_{kl} f(A(s_1, s_2, s))d\mu_s . \quad (5.4.2)$$

Hence 2-point function is average of a 3-point function over the third argument. The absence of non-trivial symplectic invariants for 1-point function means that  $n = 1$ - an are constant, most naturally vanishing, unless some kind of spontaneous symmetry breaking occurs. Since the function  $f(A(s_1, s_2, s_3))$  is arbitrary, 2-point correlation function can have both signs. 2-point correlation function is invariant under rotations and reflections.

#### 5.4.2 Symplectic QFT with spontaneous breaking of rotational and reflection symmetries

CMB data suggest breaking of rotational and reflection symmetries of  $S^2$ . A possible mechanism of spontaneous symmetry breaking is based on the observation that in TGD framework the hierarchy of Planck constants assigns to each sector of the generalized imbedding space a preferred quantization axes. The selection of the quantization axis is coded also to the geometry of "world of classical worlds", and to the quantum fluctuations of the metric in particular. Clearly, symplectic QFT with spontaneous symmetry breaking would provide the sought-for really deep reason for the quantization of Planck constant in the proposed manner.

1. The coding of angular momentum quantization axis to the generalized imbedding space geometry allows to select South and North poles as preferred points of  $S^2$ . To the three arguments  $s_1, s_2, s_3$  of the 3-point function one can assign two squares with the added point being either North or South pole. The difference

$$\Delta A(s_1, s_2, s_3) \equiv A(s_1, s_2, s_3, N) - A(s_1, s_2, s_3, S) \quad (5.4.3)$$

of the corresponding areas defines a simple symplectic invariant breaking the reflection symmetry with respect to the equatorial plane. Note that  $\Delta A$  vanishes if arguments lie along a geodesic line or if any two arguments co-incide. Quite generally, symplectic QFT differs from conformal QFT in that correlation functions do not possess singularities.

2. The reduction to 2-point correlation function gives a consistency conditions on the 3-point functions

$$\begin{aligned} \langle (\Phi_k(s_1)\Phi_l(s_2))\Phi_m(s_3) \rangle &= c_{kl}^r \int f(\Delta A(s_1, s_2, s)) \langle \Phi_r(s)\Phi_m(s_3) \rangle d\mu_s \\ &= \end{aligned} \quad (5.4.4)$$

$$c_{kl}^r c_{rm} \int f(\Delta A(s_1, s_2, s)) f(\Delta A(s, s_3, t)) d\mu_s d\mu_t . \quad (5.4.5)$$

Associativity requires that this expression equals to  $\langle \Phi_k(s_1)(\Phi_l(s_2)\Phi_m(s_3)) \rangle$  and this gives additional conditions. Associativity conditions apply to  $f(\Delta A)$  and could fix it highly uniquely.

3. 2-point correlation function would be given by

$$\langle \Phi_k(s_1)\Phi_l(s_2) \rangle = c_{kl} \int f(\Delta A(s_1, s_2, s)) d\mu_s \quad (5.4.6)$$

4. There is a clear difference between  $n > 3$  and  $n = 3$  cases: for  $n > 3$  also non-convex polygons are possible: this means that the interior angle associated with some vertices of the polygon is larger than  $\pi$ .  $n = 4$  theory is certainly well-defined, but one can argue that so are also  $n > 4$  theories and skeptic would argue that this leads to an inflation of theories. TGD however allows only finite number of preferred points and fusion rules could eliminate the hierarchy of theories.
5. To sum up, the general predictions are following. Quite generally, for  $f(0) = 0$  n-point correlation functions vanish if any two arguments co-incide which conforms with the spectrum of temperature fluctuations. It also implies that symplectic QFT is free of the usual singularities. For symmetry breaking scenario 3-point functions and thus also 2-point functions vanish also if  $s_1$  and  $s_2$  are at equator. All these are testable predictions using ensemble of CMB spectra.

### 5.4.3 Generalization to quantum TGD

Since number theoretic braids are the basic objects of quantum TGD, one can hope that the n-point functions assignable to them could code the properties of ground states and that one could separate from n-point functions the parts which correspond to the symplectic degrees of freedom acting as symmetries of vacuum extremals and isometries of the 'world of classical worlds'.

1. This approach indeed seems to generalize also to quantum TGD proper and the n-point functions associated with partonic 2-surfaces can be decomposed in such a manner that one obtains coefficients which are symplectic invariants associated with both  $S^2$  and  $CP_2$  Kähler form.
2. Fusion rules imply that the gauge fluxes of respective Kähler forms over geodesic triangles associated with the  $S^2$  and  $CP_2$  projections of the arguments of 3-point function serve basic building blocks of the correlation functions. The North and South poles of  $S^2$  and three poles of  $CP_2$  can be used to construct symmetry breaking n-point functions as symplectic invariants. Non-trivial 1-point functions vanish also now.

3. The important implication is that  $n$ -point functions vanish when some of the arguments coincide. This might play a crucial role in taming of the singularities: the basic general prediction of TGD is that standard infinities of local field theories should be absent and this mechanism might realize this expectation.

Next some more technical but elementary first guesses about what might be involved.

1. It is natural to introduce the moduli space for  $n$ -tuples of points of the symplectic manifold as the space of symplectic equivalence classes of  $n$ -tuples. In the case of sphere  $S^2$  convex  $n$ -polygon allows  $n + 1$  3-sub-polygons and the areas of these provide symplectically invariant coordinates for the moduli space of symplectic equivalence classes of  $n$ -polygons ( $2^n$ -D space of polygons is reduced to  $n + 1$ -D space). For non-convex polygons the number of 3-sub-polygons is reduced so that they seem to correspond to lower-dimensional sub-space. In the case of  $CP_2$   $n$ -polygon allows besides the areas of 3-polygons also 4-volumes of 5-polygons as fundamental symplectic invariants. The number of independent 5-polygons for  $n$ -polygon can be obtained by using induction: once the numbers  $N(k, n)$  of independent  $k \leq n$ -simplices are known for  $n$ -simplex, the numbers of  $k \leq n+1$ -simplices for  $n+1$ -polygon are obtained by adding one vertex so that by little visual gymnastics the numbers  $N(k, n+1)$  are given by  $N(k, n+1) = N(k-1, n) + N(k, n)$ . In the case of  $CP_2$  the allowance of 3 analogs  $\{N, S, T\}$  of North and South poles of  $S^2$  means that besides the areas of polygons  $(s_1, s_2, s_3)$ ,  $(s_1, s_2, s_3, X)$ ,  $(s_1, s_2, s_3, X, Y)$ , and  $(s_1, s_2, s_3, N, S, T)$  also the 4-volumes of 5-polygons  $(s_1, s_2, s_3, X, Y)$ , and of 6-polygon  $(s_1, s_2, s_3, N, S, T)$ ,  $X, Y \in \{N, S, T\}$  can appear as additional arguments in the definition of 3-point function.

2. What one really means with symplectic tensor is not clear since the naive first guess for the  $n$ -point function of tensor fields is not manifestly general coordinate invariant. For instance, in the model of CMB, the components of the metric deformation involving  $S^2$  indices would be symplectic tensors. Tensorial  $n$ -point functions could be reduced to those for scalars obtained as inner products of tensors with Killing vector fields of  $SO(3)$  at  $S^2$ . Again a preferred choice of quantization axis would be introduced and special points would correspond to the singularities of the Killing vector fields.

The decomposition of Hamiltonians of the "world of classical worlds" expressible in terms of Hamiltonians of  $S^2 \times CP_2$  to irreps of  $SO(3)$  and  $SU(3)$  could define the notion of symplectic tensor as the analog of spherical harmonic at the level of configuration space. Spin and gluon color would have natural interpretation as symplectic spin and color. The infinitesimal action of various Hamiltonians on  $n$ -point functions defined by Hamiltonians and their super counterparts is well-defined and group theoretical arguments allow to deduce general form of  $n$ -point functions in terms of symplectic invariants.

3. The need to unify p-adic and real physics by requiring them to be completions of rational physics, and the notion of finite measurement resolution suggest that discretization of also fusion algebra is necessary. The set of points appearing as arguments of  $n$ -point functions could be finite in a given resolution so that the p-adically troublesome integrals in the formulas for the fusion rules would be replaced with sums. Perhaps rational/algebraic variants of  $S^2 \times CP_2 = SO(3)/SO(2) \times SU(3)/U(2)$  obtained by replacing these groups with their rational/algebraic variants are involved. Tetrahedra, octahedra, and dodecahedra suggest themselves as simplest candidates for these discretized spaces. Also the symplectic moduli space would be discretized to contain only  $n$ -tuples for which the symplectic invariants are numbers in the allowed algebraic extension of rationals. This would provide an abstract looking but actually very concrete operational approach to the discretization involving only areas of  $n$ -tuples as internal coordinates of symplectic equivalence classes of  $n$ -tuples. The best that one could achieve would be a formulation involving nothing below measurement resolution.
4. This picture based on elementary geometry might make sense also in the case of conformal symmetries. The angles associated with the vertices of the  $S^2$  projection of  $n$ -polygon could define conformal invariants appearing in  $n$ -point functions and the algebraization of the corresponding phases would be an operational manner to introduce the space-time correlates for the roots of unity introduced at quantum level. In  $CP_2$  degrees of freedom the projections of  $n$ -tuples to the homologically trivial geodesic sphere  $S^2$  associated with the particular sector of  $CH$  would allow

to define similar conformal invariants. This framework gives dimensionless areas (unit sphere is considered). p-Adic length scale hypothesis and hierarchy of Planck constants would bring in the fundamental units of length and time in terms of  $CP_2$  length.

The recent view about  $M$ -matrix described is something almost unique determined by Connes tensor product providing a formal realization for the statement that complex rays of state space are replaced with  $\mathcal{N}$  rays where  $\mathcal{N}$  defines the hyper-finite sub-factor of type  $II_1$  defining the measurement resolution.  $M$ -matrix defines time-like entanglement coefficients between positive and negative energy parts of the zero energy state and need not be unitary. It is identified as square root of density matrix with real expressible as product of of real and positive square root and unitary  $S$ -matrix. This  $S$ -matrix is what is measured in laboratory. There is also a general vision about how vertices are realized: they correspond to light-like partonic 3-surfaces obtained by gluing incoming and outgoing partonic 3-surfaces along their ends together just like lines of Feynman diagrams. Note that in string models string world sheets are non-singular as 2-manifolds whereas 1-dimensional vertices are singular as 1-manifolds. These ingredients we should be able to fuse together. So we try once again!

1. *Iteration* starting from vertices and propagators is the basic approach in the construction of n-point function in standard QFT. This approach does not work in quantum TGD. Symplectic and conformal field theories suggest that *recursion* replaces iteration in the construction. One starts from an n-point function and reduces it step by step to a vacuum expectation value of a 2-point function using fusion rules. Associativity becomes the fundamental dynamical principle in this process. Associativity in the sense of classical number fields has already shown its power and led to a hyper-octonionic formulation of quantum TGD promising a unification of various visions about quantum TGD [K72].
2. Let us start from the representation of a zero energy state in terms of a causal diamond defined by future and past directed light-cones. Zero energy state corresponds to a quantum superposition of light-like partonic 3-surfaces each of them representing possible particle reaction. These 3-surfaces are very much like generalized Feynman diagrams with lines replaced by light-like 3-surfaces coming from the upper and lower light-cone boundaries and glued together along their ends at smooth 2-dimensional surfaces defining the generalized vertices.
3. It must be emphasized that the generalization of ordinary Feynman diagrammatics arises and conformal and symplectic QFTs appear only in the calculation of single generalized Feynman diagram. Therefore one could still worry about loop corrections. The fact that no integration over loop momenta is involved and there is always finite cutoff due to discretization together with recursive instead of iterative approach gives however good hopes that everything works. Note that this picture is in conflict with one of the earlier approaches based on positive energy ontology in which the hope was that only single generalized Feynman diagram could define the  $U$ -matrix thought to correspond to physical  $S$ -matrix at that time.
4. One can actually simplify things by identifying generalized Feynman diagrams as maxima of Kähler function with functional integration carried over perturbations around it. Thus one would have conformal field theory in both fermionic and configuration space degrees of freedom. The light-like time coordinate along light-like 3-surface is analogous to the complex coordinate of conformal field theories restricted to some curve. If it is possible continue the light-like time coordinate to a hyper-complex coordinate in the interior of 4-D space-time sheet, the correspondence with conformal field theories becomes rather concrete. Same applies to the light-like radial coordinates associated with the light-cone boundaries. At light-cone boundaries one can apply fusion rules of a symplectic QFT to the remaining coordinates. Conformal fusion rules are applied only to point pairs which are at different ends of the partonic surface and there are no conformal singularities since arguments of n-point functions do not co-incide. By applying the conformal and symplectic fusion rules one can eventually reduce the n-point function defined by the various fermionic and bosonic operators appearing at the ends of the generalized Feynman diagram to something calculable.
5. Finite measurement resolution defining the Connes tensor product is realized by the discretization applied to the choice of the arguments of n-point functions so that discretion is not only a

space-time correlate of finite resolution but actually defines it. No explicit realization of the measurement resolution algebra  $\mathcal{N}$  seems to be needed. Everything should boil down to the fusion rules and integration measure over different 3-surfaces defined by exponent of Kähler function and by imaginary exponent of Chern-Simons action. The continuation of the configuration space Clifford algebra for 3-surfaces with cm degrees of freedom fixed to a hyper-octonionic variant of gamma matrix field of super-string models defined in  $M^8$  (hyper-octonionic space) and  $M^8 \leftrightarrow M^4 \times CP_2$  duality leads to a unique choice of the points, which can contribute to n-point functions as intersection of  $M^4$  subspace of  $M^8$  with the counterparts of partonic 2-surfaces at the boundaries of light-cones of  $M^8$ . Therefore there are hopes that the resulting theory is highly unique. Symplectic fusion algebra reduces to a finite algebra for each space-time surface if this picture is correct.

6. Consider next some of the details of how the light-like 3-surface codes for the fusion rules associated with it. The intermediate partonic 2-surfaces must be involved since otherwise the construction would carry no information about the properties of the light-like 3-surface, and one would not obtain perturbation series in terms of the relevant coupling constants. The natural assumption is that partonic 2-surfaces belong to future/past directed light-cone boundary depending on whether they are on lower/upper half of the causal diamond. Hyper-octonionic conformal field approach fixes the  $n_{int}$  points at intermediate partonic two-sphere for a given light-like 3-surface representing generalized Feynman diagram, and this means that the contribution is just  $N$ -point function with  $N = n_{out} + n_{int} + n_{in}$  calculable by the basic fusion rules. Coupling constant strengths would emerge through the fusion coefficients, and at least in the case of gauge interactions they must be proportional to Kähler coupling strength since n-point functions are obtained by averaging over small deformations with vacuum functional given by the exponent of Kähler function. The first guess is that one can identify the spheres  $S^2 \subset \delta M_{\pm}^4$  associated with initial, final and, and intermediate states so that symplectic n-points functions could be calculated using single sphere.

These findings raise the hope that quantum TGD is indeed a solvable theory. Even if one is not willing to swallow any bit of TGD, the classification of the symplectic QFTs remains a fascinating mathematical challenge in itself. A further challenge is the fusion of conformal QFT and symplectic QFT in the construction of n-point functions. One might hope that conformal and symplectic fusion rules can be treated separately. This separation indeed happens since conformal degrees of freedom correspond to quantum fluctuations contributing to the configuration space metric and affecting the induced metric whereas symplectic invariants correspond to non-quantum fluctuating zero modes defining the part of quantum state not affected by quantum fluctuations parameterized by the symplectic group of  $\delta M_{\pm}^4 \times CP_2$ . Also the dream about symplectic fusion rules have been realized. An explicit construction of symplectic fusion algebras is represented in [?].

## 5.5 Weak form of electric-magnetic duality and fermionic propagator

The ideas about what generalized Feynman diagrams could be have developed rather slowly and basically through trial and mostly error. Bosonic emergence implies that fermionic propagator is the fundamental object and its identification has become one of the basic challenges of TGD. For long time the belief was that a straightforward generalization of stringy propagators could make sense but it turned out that TGD requires something more original. The weak form of electric-magnetic duality meant a decisive step of progress also in the understanding of fermionic propagator. In the following the implications of weak form of electric-magnetic duality for TGD are explained by starting from classical theory and ending up with fermionic propagator.

### 5.5.1 Could Quantum TGD reduce to almost topological QFT?

There seems to be a profound connection with the earlier unrealistic proposal that TGD reduces to almost topological quantum theory in the sense that the counterpart of Chern-Simons action assigned with the wormhole throats somehow dictates the dynamics. This proposal can be formulated also

for the modified Dirac action. I gave up this proposal but the following argument shows that Kähler action with weak form of electric-magnetic duality effectively reduces to Chern-Simons action plus Coulomb term.

1. Kähler action density can be written as a 4-dimensional integral of the Coulomb term  $j_K^\alpha A_\alpha$  plus and integral of the boundary term  $J^{n\beta} A_\beta \sqrt{g_4}$  over the wormhole throats and of the quantity  $J^{0\beta} A_\beta \sqrt{g_4}$  over the ends of the 3-surface.
2. If the self-duality conditions generalize to  $J^{n\beta} = 4\pi\alpha_K \epsilon^{n\beta\gamma\delta} J_{\gamma\delta}$  at throats and to  $J^{0\beta} = 4\pi\alpha_K \epsilon^{0\beta\gamma\delta} J_{\gamma\delta}$  at the ends, the Kähler function reduces to the counterpart of Chern-Simons action evaluated at the ends and throats. It would have same value for each branch and the replacement  $\hbar_0 \rightarrow r\hbar_0$  would effectively describe this. Boundary conditions would however give  $1/r$  factor so that  $\hbar$  would disappear from the Kähler function! The original attempt to realize quantum TGD as an almost topological QFT was in terms of Chern-Simons action but was given up. It is somewhat surprising that Kähler action gives Chern-Simons action in the vacuum sector defined as sector for which Kähler current is light-like or vanishes.

Holography encourages to ask whether also the Coulomb interaction terms could vanish. This kind of dimensional reduction would mean an enormous simplification since TGD would reduce to an almost topological QFT. The attribute "almost" would come from the fact that one has non-vanishing classical Noether charges defined by Kähler action and non-trivial quantum dynamics in  $M^4$  degrees of freedom. One could also assign to space-time surfaces conserved four-momenta which is not possible in topological QFTs. For this reason the conditions guaranteeing the vanishing of Coulomb interaction term deserve a detailed analysis.

1. For the known extremals  $j_K^\alpha$  either vanishes or is light-like ("massless extremals" for which weak self-duality condition does not make sense [K9] ) so that the Coulombic term vanishes identically in the gauge used. The addition of a gradient to  $A$  induces terms located at the ends and wormhole throats of the space-time surface but this term must be cancelled by the other boundary terms by gauge invariance of Kähler action. This implies that the  $M^4$  part of WCW metric vanishes in this case. Therefore massless extremals as such are not physically realistic: wormhole throats representing particles are needed.
2. The original naive conclusion was that since Chern-Simons action depends on  $CP_2$  coordinates only, its variation with respect to Minkowski coordinates must vanish so that the WCW metric would be trivial in  $M^4$  degrees of freedom. This conclusion is in conflict with quantum classical correspondence and was indeed too hasty. The point is that the allowed variations of Kähler function must respect the weak electro-magnetic duality which relates Kähler electric field depending on the induced 4-metric at 3-surface to the Kähler magnetic field. Therefore the dependence on  $M^4$  coordinates creeps via a Lagrange multiplier term

$$\int \Lambda_\alpha (J^{n\alpha} - K \epsilon^{n\alpha\beta\gamma} J_{\beta\gamma}) \sqrt{g_4} d^3 x . \quad (5.5.1)$$

The (1,1) part of second variation contributing to  $M^4$  metric comes from this term.

3. This erratic conclusion about the vanishing of  $M^4$  part WCW metric raised the question about how to achieve a non-trivial metric in  $M^4$  degrees of freedom. The proposal was a modification of the weak form of electric-magnetic duality. Besides  $CP_2$  Kähler form there would be the Kähler form assignable to the light-cone boundary reducing to that for  $r_M = \text{constant}$  sphere - call it  $J^1$ . The generalization of the weak form of self-duality would be  $J^{n\beta} = \epsilon^{n\beta\gamma\delta} K (J_{\gamma\delta} + \epsilon J_{\gamma\delta}^1)$ . This form implies that the boundary term gives a non-trivial contribution to the  $M^4$  part of the WCW metric even without the constraint from electric-magnetic duality. Kähler charge is not affected unless the partonic 2-surface contains the tip of  $CD$  in its interior. In this case the value of Kähler charge is shifted by a topological contribution. Whether this term can survive depends on whether the resulting vacuum extremals are consistent with the basic facts about classical gravitation.

4. The Coulombic interaction term is not invariant under gauge transformations. The good news is that this might allow to find a gauge in which the Coulomb term vanishes. The vanishing condition fixing the gauge transformation  $\phi$  is

$$j_K^\alpha \partial_\alpha \phi = -j^\alpha A_\alpha \quad . \quad (5.5.2)$$

This differential equation can be reduced to an ordinary differential equation along the flow lines  $j_K$  by using  $dx^\alpha/dt = j_K^\alpha$ . Global solution is obtained only if one can combine the flow parameter  $t$  with three other coordinates- say those at the either end of  $CD$  to form space-time coordinates. The condition is that the parameter defining the coordinate differential is proportional to the covariant form of Kähler current:  $dt = \phi j_K$ . This condition in turn implies  $d^2t = d(\phi j_K) = d(\phi j_K) = d\phi \wedge j_K + \phi dj_K = 0$  implying  $j_K \wedge dj_K = 0$  or more concretely,

$$\epsilon^{\alpha\beta\gamma\delta} j_\beta^K \partial_\gamma j_\delta^K = 0 \quad . \quad (5.5.3)$$

$j_K$  is a four-dimensional counterpart of Beltrami field [?] and could be called generalized Beltrami field.

The integrability conditions follow also from the construction of the extremals of Kähler action [K9]. The conjecture was that for the extremals the 4-dimensional Lorentz force vanishes (no dissipation): this requires  $j_K \wedge J = 0$ . One manner to guarantee this is the topologization of the Kähler current meaning that it is proportional to the instanton current:  $j_K = \phi j_I$ , where  $j_I = *(J \wedge A)$  is the instanton current, which is not conserved for 4-D  $CP_2$  projection. The conservation of  $j_K$  implies the condition  $j_I^\alpha \partial_\alpha \phi = \partial_\alpha j^\alpha \phi$  and from this  $\phi$  can be integrated if the integrability condition  $j_I \wedge dj_I = 0$  holds true implying the same condition for  $j_K$ . By introducing at least 3 or  $CP_2$  coordinates as space-time coordinates, one finds that the contravariant form of  $j_I$  is purely topological so that the integrability condition fixes the dependence on  $M^4$  coordinates and this selection is coded into the scalar function  $\phi$ . These functions define families of conserved currents  $j_K^\alpha \phi$  and  $j_I^\alpha \phi$  and could be also interpreted as conserved currents associated with the critical deformations of the space-time surface.

5. There are gauge transformations respecting the vanishing of the Coulomb term. The vanishing condition for the Coulomb term is gauge invariant only under the gauge transformations  $A \rightarrow A + \nabla\phi$  for which the scalar function the integral  $\int j_K^\alpha \partial_\alpha \phi$  reduces to a total divergence a giving an integral over various 3-surfaces at the ends of  $CD$  and at throats vanishes. This is satisfied if the allowed gauge transformations define conserved currents

$$D_\alpha(j^\alpha \phi) = 0 \quad . \quad (5.5.4)$$

As a consequence Coulomb term reduces to a difference of the conserved charges  $Q_\phi^e = \int j^0 \phi \sqrt{g_4} d^3x$  at the ends of the CD vanishing identically. The change of the imons type term is trivial if the total weighted Kähler magnetic flux  $Q_\phi^m = \sum \int J \phi dA$  over wormhole throats is conserved. The existence of an infinite number of conserved weighted magnetic fluxes is in accordance with the electric-magnetic duality. How these fluxes relate to the flux Hamiltonians central for WCW geometry is not quite clear.

6. The gauge transformations respecting the reduction to almost topological QFT should have some special physical meaning. The measurement interaction term in the modified Dirac interaction corresponds to a critical deformation of the space-time sheet and is realized as an addition of a gauge part to the Kähler gauge potential of  $CP_2$ . It would be natural to identify this gauge transformation giving rise to a conserved charge so that the conserved charges would provide a representation for the charges associated with the infinitesimal critical deformations not affecting Kähler action. The gauge transformed Kähler potential couples to the modified



Dirac equation and its effect could be visible in the value of Kähler function and therefore also in the properties of the preferred extremal. The effect on WCW metric would however vanish since  $K$  would transform only by an addition of a real part of a holomorphic function. Kähler function is identified as a Dirac determinant for Chern-Simons Dirac action and the spectrum of this operator should not be invariant under these gauge transformations if this picture is correct. This is achieved if the gauge transformation is carried only in the Dirac action corresponding to the Chern-Simons term: this assumption is motivated by the breaking of time reversal invariance induced by quantum measurements. The modification of Kähler action can be guessed to correspond just to the Chern-Simons contribution from the instanton term.

7. A reasonable looking guess for the explicit realization of the quantum classical correspondence between quantum numbers and space-time geometry is that the deformation of the preferred extremal due to the addition of the measurement interaction term is induced by a  $U(1)$  gauge transformation induced by a transformation of  $\delta CD \times CP_2$  generating the gauge transformation represented by  $\phi$ . This interpretation makes sense if the fluxes defined by  $Q_\phi^m$  and corresponding Hamiltonians affect only zero modes rather than quantum fluctuating degrees of freedom.

To sum up, one could understand the basic properties of WCW metric in this framework. Effective 2-dimensionality would result from the existence of an infinite number of conserved charges in two different time directions (genuine conservation laws plus gauge fixing). The infinite-dimensional symmetric space for given values of zero modes corresponds to the Cartesian product of the WCWs associated with the partonic 2-surfaces at both ends of  $CD$  and the generalized Chern-Simons term decomposes into a sum of terms from the ends giving single particle Kähler functions and to the terms from light-like wormhole throats giving interaction term between positive and negative energy parts of the state. Hence Kähler function could be calculated without any knowledge about the interior of the space-time sheets and TGD would reduce to almost topological QFT as speculated earlier. Needless to say this would have immense boost to the program of constructing WCW Kähler geometry.

### 5.5.2 A general solution ansatz based on almost topological QFT property

The basic vision behind the ansatz is the reduction of quantum TGD to almost topological field theory. This requires that the flow parameters associated with the flow lines of isometry currents and Kähler current extend to global coordinates. This leads to integrability conditions implying generalized Beltrami flow and Kähler action for the preferred extremals reduces to Chern-Simons action when weak electro-weak duality is applied as boundary conditions. The strongest form of the hydrodynamical interpretation requires that all conserved currents are parallel to Kähler current. In the more general case one would have several hydrodynamic flows. Also the braidings (several of them for the most general ansatz) assigned with the light-like 3-surfaces are naturally defined by the flow lines of conserved currents. The independent behavior of particles at different flow lines can be seen as a realization of the complete integrability of the theory. In free quantum field theories on mass shell Fourier components are in a similar role but the geometric interpretation in terms of flow is of course lacking. This picture should generalize also to the solution of the modified Dirac equation.

#### Basic field equations

Consider first the equations at general level.

1. The breaking of the Poincare symmetry due to the presence of monopole field occurs and leads to the isometry group  $T \times SO(3) \times SU(3)$  corresponding to time translations, rotations, and color group. The Cartan algebra is four-dimensional and field equations reduce to the conservation laws of energy  $E$ , angular momentum  $J$ , color isospin  $I_3$ , and color hypercharge  $Y$ .
2. Quite generally, one can write the field equations as conservation laws for  $I, J, I_3$ , and  $Y$ .

$$D_\alpha [D_\beta (J^{\alpha\beta} H_A) - j_K^\alpha H^A + T^{\alpha\beta} j_A^l h_{kl} \partial_\beta h^l] = 0 . \quad (5.5.5)$$

The first term gives a contraction of the symmetric Ricci tensor with antisymmetric Kähler form and vanishes so that one has

$$D_\alpha [j_K^\alpha H^A - T^{\alpha\beta} j_A^k h_{kl} \partial_\beta h^l] = 0 . \quad (5.5.6)$$

For energy one has  $H_A = 1$  and energy current associated with the flow lines is proportional to the Kähler current. Its divergence vanishes identically.

3. One can express the divergence of the term involving energy momentum tensor as a sum of terms involving  $j_K^\alpha J_{\alpha\beta}$  and contraction of second fundamental form with energy momentum tensor so that one obtains

$$j_K^\alpha D_\alpha H^A = j_K^\alpha J_{\alpha\beta} j_\beta^A + T^{\alpha\beta} H_{\alpha\beta}^k j_k^A . \quad (5.5.7)$$

### Hydrodynamical solution ansatz

The characteristic feature of the solution ansatz would be the reduction of the dynamics to hydrodynamics analogous to that for a continuous distribution of particles initially at the end of  $X^3$  of the light-like 3-surface moving along flow lines defined by currents  $j_A$  satisfying the integrability condition  $j_A \wedge dj_A = 0$ . Field theory would reduce effectively to particle mechanics along flow lines with conserved charges defined by various isometry currents. The strongest condition is that all isometry currents  $j_A$  and also Kähler current  $j_K$  are proportional to the same current  $j$ . The more general option corresponds to multi-hydrodynamics.

Conserved currents are analogous to hydrodynamical currents in the sense that the flow parameter along flow lines extends to a global space-time coordinate. The conserved current is proportional to the gradient  $\nabla\Phi$  of the coordinate varying along the flow lines:  $J = \Psi\nabla\Phi$  and by a proper choice of  $\Psi$  one can allow to have conservation. The initial values of  $\Psi$  and  $\Phi$  can be selected freely along the flow lines beginning from either the end of the space-time surface or from wormhole throats.

If one requires hydrodynamics also for Chern-Simons action (effective 2-dimensionality is required for preferred extremals), the initial values of scalar functions can be chosen freely only at the partonic 2-surfaces. The freedom to choose the initial values of the charges conserved along flow lines at the partonic 2-surfaces means the existence of an infinite number of conserved charges so that the theory would be integrable and even in two different coordinate directions. The basic difference as compared to ordinary conservation laws is that the conserved currents are parallel and their flow parameter extends to a global coordinate.

1. The most general assumption is that the conserved isometry currents

$$J_A^\alpha = j_K^\alpha H^A - T^{\alpha\beta} j_A^k h_{kl} \partial_\beta h^l \quad (5.5.8)$$

and Kähler current are integrable in the sense that  $J_A \wedge J_A = 0$  and  $j_K \wedge j_K = 0$  hold true. One could imagine the possibility that the currents are not parallel.

2. The integrability condition  $dJ_A \wedge J_A = 0$  is satisfied if one has

$$J_A = \Psi_A d\Phi_A . \quad (5.5.9)$$

The conservation of  $J_A$  gives

$$d * (\Psi_A d\Phi_A) = 0 . \quad (5.5.10)$$

This would mean separate hydrodynamics for each of the currents involved. In principle there is no need to assume any further conditions and one can imagine infinite basis of scalar function pairs  $(\Psi_A, \Phi_A)$  since criticality implies infinite number deformations implying conserved Noether currents.

3. The conservation condition reduces to d'Alembert equation in the induced metric if one assumes that  $\nabla\Psi_A$  is orthogonal with every  $d\Phi_A$ .

$$d * d\Phi_A = 0 \quad , \quad d\Psi_A \cdot d\Phi_A = 0 \quad . \quad (5.5.11)$$

Taking  $x = \Phi_A$  as a coordinate the orthogonality condition states  $g^{xj}\partial_j\Psi_A = 0$  and in the general case one cannot solve the condition by simply assuming that  $\Psi_A$  depends on the coordinates transversal to  $\Phi_A$  only. These conditions bring in mind  $p \cdot p = 0$  and  $p \cdot e$  condition for massless modes of Maxwell field having fixed momentum and polarization.  $d\Phi_A$  would correspond to  $p$  and  $d\Psi_A$  to polarization. The condition that each isometry current corresponds its own pair  $(\Psi_A, \Phi_A)$  would mean that each isometry current corresponds to independent light-like momentum and polarization. Ordinary free quantum field theory would support this view whereas hydrodynamics and QFT limit of TGD would support single flow.

These are the most general hydrodynamical conditions that one can assume. One can consider also more restricted scenarios.

1. The strongest ansatz is inspired by the hydrodynamical picture in which all conserved isometry charges flow along same flow lines so that one would have

$$J_A = \Psi_A d\Phi \quad . \quad (5.5.12)$$

In this case same  $\Phi$  would satisfy simultaneously the d'Alembert type equations.

$$d * d\Phi = 0 \quad , \quad d\Psi_A \cdot d\Phi = 0. \quad (5.5.13)$$

This would mean that the massless modes associated with isometry currents move in parallel manner but can have different polarizations. The spinor modes associated with light-like like 3-surfaces carry parallel four-momenta, which suggest that this option is correct. This allows a very general family of solutions and one can have a complete 3-dimensional basis of functions  $\Psi_A$  with gradient orthogonal to  $d\Phi$ .

2. Isometry invariance under  $T \times SO(3) \times SU(3)$  allows to consider the possibility that one has

$$J_A = k_A \Psi_A d\Phi_{G(A)} \quad , \quad d * (d\Phi_{G(A)}) = 0 \quad , \quad d\Psi_A \cdot d\Phi_{G(A)} = 0 \quad . \quad (5.5.14)$$

where  $G(A)$  is  $T$  for energy current,  $SO(3)$  for angular momentum currents and  $SU(3)$  for color currents. Energy would thus flow along its own flux lines, angular momentum along its own flow lines, and color quantum numbers along their own flow lines. For instance, color currents would differ from each other only by a numerical constant. The replacement of  $\Psi_A$  with  $\Psi_{G(A)}$  would be too strong a condition since Killing vector fields are not related by a constant factor.

To sum up, the most general option is that each conserved current  $J_A$  defines its own integrable flow lines defined by the scalar function pair  $(\Psi_A, \Phi_A)$ . A complete basis of scalar functions satisfying the d'Alembert type equation guaranteeing current conservation could be imagined with restrictions coming from the effective 2-dimensionality reducing the scalar function basis effectively to the partonic 2-surface. The diametrically opposite option corresponds to the basis obtained by assuming that only single  $\Phi$  is involved.

The proposed solution ansatz can be compared to the earlier ansatz [?] stating that Kähler current is topologized in the sense that for  $D(CP_2) = 3$  it is proportional to the identically conserved

instanton current (so that 4-D Lorentz force vanishes) and vanishes for  $D(CP_2) = 4$  (Maxwell phase). This hypothesis requires that instanton current is Beltrami field for  $D(CP_2) = 3$ . In the recent case the assumption that also instanton current satisfies the Beltrami hypothesis in strong sense (single function  $\Phi$ ) generalizes the topologization hypothesis for  $D(CP_2) = 3$ . As a matter fact, the topologization hypothesis applies to isometry currents also for  $D(CP_2) = 4$  although instanton current is not conserved anymore.

### Can one require the extremal property in the case of Chern-Simons action?

Effective 2-dimensionality is achieved if the ends and wormhole throats are extremals of Chern-Simons action. The strongest condition would be that space-time surfaces allow orthogonal slicings by 3-surfaces which are extremals of Chern-Simons action.

Also in this case one can require that the flow parameter associated with the flow lines of the isometry currents extends to a global coordinate. Kähler magnetic field  $B = *J$  defines a conserved current so that all conserved currents would flow along the field lines of  $B$  and one would have 3-D Beltrami flow. Note that in magnetohydrodynamics the standard assumption is that currents flow along the field lines of the magnetic field.

For wormhole throats light-likeness causes some complications since the induced metric is degenerate and the contravariant metric must be restricted to the complement of the light-like direction. This means that d'Alembert equation reduces to 2-dimensional Laplace equation. For space-like 3-surfaces one obtains the counterpart of Laplace equation with partonic 2-surfaces serving as sources. The interpretation in terms of analogs of Coulomb potentials created by 2-D charge distributions would be natural.

### 5.5.3 Hydrodynamic picture in fermionic sector

Super-symmetry inspires the conjecture that the hydrodynamical picture applies also to the solutions of the modified Dirac equation.

#### 4-dimensional modified Dirac equation and hydrodynamical picture

Consider first the solutions of the induced spinor field in the interior of space-time surface.

1. The local inner products of the modes of the induced spinor fields define conserved currents

$$\begin{aligned} D_\alpha J_{mn}^\alpha &= 0 , \\ J_{mn}^\alpha &= \bar{u}_m \hat{\Gamma}^\alpha u_n , \\ \hat{\Gamma}^\alpha &= \frac{\partial L_K}{\partial(\partial_\alpha h^k)} \Gamma_k . \end{aligned} \quad (5.5.15)$$

The conjecture is that the flow parameters of also these currents extend to a global coordinate so that one would have in the completely general case the condition

$$\begin{aligned} J_{mn}^\alpha &= \Phi_{mn} d\Psi_{mn} , \\ d*(d\Phi_{mn}) &= 0 , \quad \nabla \Psi_{mn} \cdot \Phi_{mn} = 0 . \end{aligned} \quad (5.5.16)$$

The condition  $\Phi_{mn} = \Phi$  would mean that the massless modes propagate in parallel manner and along the flow lines of Kähler current. The conservation condition along the flow line implies that the current component  $J_{mn}$  is constant along it. Everything would reduce to initial values at the ends of the space-time sheet boundaries of  $CD$  and 3-D modified Dirac equation would reduce everything to initial values at partonic 2-surfaces.

2. One might hope that the conservation of these super currents for all modes is equivalent with the modified Dirac equation. The modes  $u_n$  appearing in  $\Psi$  in quantized theory would be kind of "square roots" of the basis  $\Phi_{mn}$  and the challenge would be to deduce the modes from the conservation laws.
3. The quantization of the induced spinor field in 4-D sense would be fixed by those at 3-D space-like ends by the fact that the oscillator operators are carried along the flow lines as such so that the anti-commutator of the induced spinor field at the opposite ends of the flow lines at the light-like boundaries of  $CD$  is in principle fixed by the anti-commutations at the either end. The anti-commutations at 3-D surfaces cannot be fixed freely since one has 3-D Chern-Simons flow reducing the anti-commutations to those at partonic 2-surfaces.

The following argument suggests that induced spinor fields are in a suitable gauge simply constant along the flow lines of the Kähler current just as massless spinor modes are constant along the geodesic in the direction of momentum.

1. The modified gamma matrices are of form  $T_k^\alpha \Gamma^k$ ,  $T_k^\alpha = \partial L_K / \partial (\partial_\alpha h^k)$ . The H-vectors  $T_k^\alpha$  can be expressed as linear combinations of a subset of Killing vector fields  $j_A^k$  spanning the tangent space of  $H$ . For  $CP_2$  the natural choice are the 4 Lie-algebra generators in the complement of  $U(2)$  sub-algebra. For  $CD$  one can use generator time translation and three generators of rotation group  $SO(3)$ . The completeness of the basis defined by the subset of Killing vector fields gives completeness relation  $h_l^k = j^{Ak} j_{Ak}$ . This implies  $T^{\alpha k} = T^{\alpha k} j_A^k j_A^k = T^{\alpha A} j_A^k$ . One can define gamma matrices  $\Gamma_A$  as  $\Gamma_k j_A^k$  to get  $T_k^\alpha \Gamma^k = T^{\alpha A} \Gamma_A$ .
2. This together with the condition that all isometry currents are proportional to the Kähler current (or if this vanishes to some conserved current- say energy current) satisfying Beltrami flow property implies that one can reduce the modified Dirac equation to an ordinary differential equation along flow lines. The quantities  $T^{tA}$  are constant along the flow lines and one obtains

$$T^{tA} j_A D_t \Psi = 0 . \tag{5.5.17}$$

By choosing the gauge suitably the spinors are just constant along flow lines so that the spinor basis reduces by effective 2-dimensionality to a complete spinor basis at partonic 2-surfaces.

**Generalized eigen modes for the modified Chern-Simons Dirac equation and hydrodynamical picture**

Hydrodynamical picture helps to understand also the construction of generalized eigen modes of 3-D Chern-Simons Dirac equation.

*1. The general form of generalized eigenvalue equation for Chern-Simons Dirac action*

Consider first the the general form and interpretation of the generalized eigenvalue equation assigned with the modified Dirac equation for Chern-Simons action [K15] . This is of course only an approximation since an additional contribution to the modified gamma matrices from the Lagrangian multiplier term guaranteeing the weak form of electric-magnetic duality must be included.

1. The modified Dirac equation for  $\Psi$  is consistent with that for its conjugate if the coefficient of the instanton term is real and one uses the Dirac action  $\bar{\Psi}(D^\rightarrow - D^\leftarrow)\Psi$  giving modified Dirac equation as

$$D_{C-S} \Psi + \frac{1}{2} (D_\alpha \hat{\Gamma}_{C-S}^\alpha) \Psi = 0 . \tag{5.5.18}$$

As noticed, the divergence  $D_\alpha \hat{\Gamma}_{C-S}^\alpha$  does not contain second derivatives in the case of Chern-Simons action. In the case of Kähler action they occur unless field equations equivalent with the

vanishing of the divergence term are satisfied. The extremals of Chern-Simons action provide a natural manner to define effective 2-dimensionality.

Also the fermionic current is conserved in this case, which conforms with the idea that fermions flow along the light-like 3-surfaces. If one uses the action  $\bar{\Psi}D\rightarrow\Psi$ ,  $\bar{\Psi}$  does not satisfy the Dirac equation following from the variational principle and fermion current is not conserved.

2. The generalized eigen modes of  $D_{C-S}$  should be such that one obtains the counterpart of Dirac propagator which is purely algebraic and does not therefore depend on the coordinates of the throat. This is satisfied if the generalized eigenvalues are expressible in terms of covariantly constant combinations of gamma matrices and here only  $M^4$  gamma matrices are possible. Therefore the eigenvalue equation would read as

$$D\Psi = \lambda^k \gamma_k \Psi, \quad D = D_{C-S} + \frac{1}{2} D_\alpha \hat{\Gamma}_{C-S}^\alpha, \quad D_{C-S} = \hat{\Gamma}_{C-S}^\alpha D_\alpha. \quad (5.5.19)$$

Here the covariant derivatives  $D_\alpha$  contain the measurement interaction term as an apparent gauge term. For extremals one has

$$D = D_{C-S}. \quad (5.5.20)$$

Covariant constancy allows to take the square of this equation and one has

$$(D^2 + [D, \lambda^k \gamma_k])\Psi = \lambda^k \lambda_k \Psi. \quad (5.5.21)$$

The commutator term is analogous to magnetic moment interaction.

3. The generalized eigenvalues correspond to  $\lambda = \sqrt{\lambda^k \lambda_k}$  and Dirac determinant is defined as a product of the eigenvalues and conjecture to give the exponent of Kähler action reducing to Chern-Simons term.  $\lambda$  is completely analogous to mass.  $\lambda_k$  cannot be however interpreted as ordinary four-momentum: for instance, number theoretic arguments suggest that  $\lambda_k$  must be restricted to the preferred plane  $M^2 \subset M^4$  interpreted as a commuting hyper-complex plane of complexified quaternions. For incoming lines this mass would vanish so that all incoming particles irrespective their actual quantum numbers would be massless in this sense and the propagator is indeed that for a massless particle. Note that the eigen-modes define the boundary values for the solutions of  $D_K\Psi = 0$  so that the values of  $\lambda$  indeed define the counterpart of the momentum space.

This transmutation of massive particles to effectively massless ones might make possible the application of the twistor formalism as such in TGD framework [?].  $N = 4$  SUSY is one of the very few gauge theory which might be UV finite but it is definitely unphysical due to the masslessness of the basic quanta. Could the resolution of the interpretational problems be that the four-momenta appearing in this theory do not directly correspond to the observed four-momenta?

## 2. Inclusion of the constraint term

As already noticed one must include also the constraint term due to the weak form of electric-magnetic duality and this changes somewhat the above simple picture.

1. At the 3-dimensional ends of the space-time sheet and at wormhole throats the 3-dimensionality allows to introduce a coordinate varying along the flow lines of Kähler magnetic field  $B = *J$ . In this case the integrability conditions state that the flow is Beltrami flow. Note that the value of  $B^\alpha$  along the flow line defining magnetic flux appearing in anti-commutation relations is constant. This suggests that the generalized eigenvalue equation for the Chern-Simons action reduces to a collection of ordinary apparently independent differential equations associated with the flow lines beginning from the partonic 2-surface. This indeed happens when the  $CP_2$  projection is 2-dimensional. In this case it however seems that the basis  $u_n$  is not of much help.
2. The conclusion is wrong: the variations of Chern-Simons action are subject to the constraint that electric-magnetic duality holds true expressible in terms of Lagrange multiplier term

$$\int \Lambda_\alpha (J^{n\alpha} - K \epsilon^{n\alpha\beta\gamma} J_{\beta\gamma}) \sqrt{g_4} d^3 x . \quad (5.5.22)$$

This gives a constraint force to the field equations and also a dependence on the induced 4-metric so that one has only almost topological QFT. This term also guarantees the  $M^4$  part of WCW Kähler metric is non-trivial. The condition that the ends of space-time sheet and wormhole throats are extrema of Chern-Simons action subject to the electric-magnetic duality constraint is strongly suggested by the effective 2-dimensionality. Without the constraint term Chern-Simons action would vanish for its extremals so that Kähler function would be identically zero.

This term implies also an additional contribution to the modified gamma matrices besides the contribution coming from Chern-Simons action so that the first guess for the modified Dirac operator would not be quite correct. This contribution is of exactly of the same general form as the contribution for any general coordinate invariant action. The dependence of the induced metric on  $M^4$  degrees of freedom guarantees that also  $M^4$  gamma matrices are present. In the following this term will not be considered.

3. When the contribution of the constraint term to the modified gamma matrices is neglected, the explicit expression of the modified Dirac operator  $D_{C-S}$  associated with the Chern-Simons term is given by

$$\begin{aligned} D &= \hat{\Gamma}^\mu D_\mu + \frac{1}{2} D_\mu \hat{\Gamma}^\mu , \\ \hat{\Gamma}^\mu &= \frac{\partial L_{C-S}}{\partial_\mu h^k} \Gamma_k = \epsilon^{\mu\alpha\beta} [2J_{kl} \partial_\alpha h^l A_\beta + J_{\alpha\beta} A_k] \Gamma^k D_\mu , \\ D_\mu \hat{\Gamma}^\mu &= B_K^\alpha (J_{k\alpha} + \partial_\alpha A_k) , \\ B_K^\alpha &= \epsilon^{\alpha\beta\gamma} J_{\beta\gamma} , \quad J_{k\alpha} = J_{kl} \partial_\alpha s^l , \quad \hat{\epsilon}^{\alpha\beta\gamma} = \epsilon^{\alpha\beta\gamma} \sqrt{g_3} . \end{aligned} \quad (5.5.23)$$

For the extremals of Chern-Simons action one has  $D_\alpha \hat{\Gamma}^\alpha = 0$ . Analogous condition holds true when the constraining contribution to the modified gamma matrices is added.

### 3. Generalized eigenvalue equation for Chern-Simons Dirac action

Consider now the Chern-Simons Dirac equation in more detail assuming that the inclusion of the constraint contribution to the modified gamma matrices does not induce any complications. Assume also extremal property for Chern-Simons action with constraint term and Beltrami flow property.

1. For the extremals the Chern-Simons Dirac operator (constraint term not included) reduces to a one-dimensional Dirac operator

$$D_{C-S} = \hat{\epsilon}^{r\alpha\beta} [2J_{k\alpha} A_\beta + J_{\alpha\beta} A_k] \Gamma^k D_r . \quad (5.5.24)$$

Constraint term implies only a modification of the modified gamma matrices but the form of the operator remains otherwise same when extrema are in question so that one has  $D_\alpha \hat{\Gamma}^\alpha = 0$ .

2. For the extremals of Chern-Simons action the general solution of the modified Chern-Simons Dirac equation ( $\lambda^k = 0$ ) is covariantly constant with respect to the coordinate  $r$ :

$$D_r \Psi = 0 . \quad (5.5.25)$$

The solution to this condition can be written immediately in terms of a non-integrable phase factor  $P \exp(i \int A_r dr)$ , where integration is along curve with constant transversal coordinates. If  $\hat{\Gamma}^v$  is light-like vector field also  $\hat{\Gamma}^v \Psi_0$  defines a solution of  $D_{C-S}$ . This solution corresponds to a zero mode for  $D_{C-S}$  and does not contribute to the Dirac determinant (suggested to give rise to the exponent of Kähler function identified as Kähler action). Note that the dependence of these solutions on transversal coordinates of  $X_i^3$  is arbitrary which conforms with the hydrodynamic picture. The solutions of Chern-Simons-Dirac are obtained by similar integration procedure also when extremals are not in question.

The formal solution associated with a general eigenvalue  $\lambda$  can be constructed by integrating the eigenvalue equation separately along all coordinate curves. This makes sense if  $r$  indeed assigned to possibly light-like flow lines of  $B^\alpha$  or more general Beltrami field possible induced by the constraint term. There are very strong consistency conditions coming from the conditions that  $\Psi$  in the interior is constant along the flow lines of Kähler current and continuous at the ends and throats (call them collectively boundaries), where  $\Psi$  has a non-trivial variation along the flow lines of  $B^\alpha$ .

1. This makes sense only if the flow lines of the Kähler current are transversal to the boundaries so that the spinor modes at boundaries dictate the modes of the spinor field in the interior. Effective 2-dimensionality means that the spinor modes in the interior can be calculated either by starting from the throats or from the ends so that the data at either upper or lower partonic 2-surfaces dictates everything in accordance with zero energy ontology.
2. This gives an infinite number of commuting diagrams stating that the flow-line time evolution along flow lines along wormhole throats from lower partonic 2-surface to the upper one is equivalent with the flow-line time evolution along the lower end of space-time surface to interior, then along interior to the upper end of the space-time surface and then back to the upper partonic 2-surface. If the space-time surface allows a slicing by partonic 2-surfaces these conditions can be assumed for any pair of partonic 2-surfaces connected by Chern-Simons flow evolution.
3. Since the time evolution along interior keeps the spinor field as constant in the proper gauge and since the flow evolutions at the lower and upper ends are in a reverse direction, there is a strong attemptation to assume that the spinor field at the ends of the of the flow lines of Kähler magnetic field are identical apart from a gauge transformation. This leads to a particle-in-box quantization of the values of the pseudo-mass (periodic boundary conditions). These conditions will be assumed in the sequel.

These assumptions lead to the following picture about the generalized eigen modes.

1. By choosing the gauge so that covariant derivative reduces to ordinary derivative and using the constancy of  $\hat{\Gamma}^r$ , the solution of the generalized eigenvalue equation can be written as

$$\begin{aligned} \Psi &= \exp(iL(r)\hat{\Gamma}^r \lambda^k \Gamma_k) \Psi_0 , \\ L(r) &= \int_0^r \frac{1}{\sqrt{\hat{g}^{rr}}} dr . \end{aligned} \quad (5.5.26)$$

$L(r)$  can be regarded as the along flux line as defined by the effective metric defined by modified gamma matrices. If  $\lambda_k$  is linear combination of  $\Gamma^0$  and  $\Gamma^{r_M}$  it anti-commutes with  $\Gamma^r$  which contains only  $CP_2$  gamma matrices so that the pseudo-momentum is a priori arbitrary.



2. When the constraint term taking care of the electric-magnetic duality is included, also  $M^4$  gamma matrices are present. If they are in the orthogonal complement of a preferred plane  $M^2 \subset M^4$ , anti-commutativity is achieved. This assumption cannot be fully justified yet but conforms with the general physical vision. There is an obvious analogy with the condition that polarizations are in a plane orthogonal to  $M^2$ . The condition indeed states that only transversal deformations define quantum fluctuating WCW degrees of freedom contributing to the WCW Kähler metric. In  $M^8-H$  duality the preferred plane  $M^2$  is interpreted as a hyper-complex plane belonging to the tangent space of the space-time surface and defines the plane of non-physical polarizations. Also a generalization of this plane to an integrable distribution of planes  $M^2(x)$  has been proposed and one must consider also now the possibility of a varying plane  $M^2(x)$  for the pseudo-momenta. The scalar function  $\Phi$  appearing in the general solution ansatz for the field equations satisfies massless d'Alembert equation and its gradient defines a local light-like direction at space-time-level and hence a 2-D plane of the tangent space. Maybe the projection of this plane to  $M^4$  could define the preferred  $M^2$ . The minimum condition is that these planes are defined only at the ends of space-time surface and at wormhole throats.
3. If one accepts this hypothesis, one can write

$$\begin{aligned}\Psi &= \left[ \cos(L(r)\lambda) + i \sin(\lambda(r)) \hat{\Gamma}^r \lambda^k \Gamma_k \right] \Psi_0, \\ \lambda &= \sqrt{\lambda_k \lambda^k}.\end{aligned}\tag{5.5.27}$$

4. Boundary conditions should fix the spectrum of masses. If the the flow lines of Kähler current coincide with the flow lines of Kähler magnetic field or more general Beltrami current at wormhole throats one ends up with difficulties since the induced spinor fields must be constant along flow lines and only trivial eigenvalues are possible. Hence it seems that the two Beltrami fields must be transversal. This requires that at the partonic 2-surfaces the value of the induced spinor mode in the interior coincides with its value at the throat. Since the induced spinor fields in interior are constant along flow lines, one must have

$$\exp(i\lambda L_{(max)}) = 1.\tag{5.5.28}$$

This implies that one has essentially particle in a box with size defined by the effective metric

$$\lambda_n = \frac{n2\pi}{L(r_{max})}.\tag{5.5.29}$$

5. This condition cannot however hold true simultaneously for all points of the partonic 2-surfaces since  $L(r_{max})$  depends on the point of the surface. In the most general case one can consider only a subset consisting of the points for which the values of  $L(r_{max})$  are rational multiples of the value of  $L(r_{max})$  at one of the points -call it  $L_0$ . This implies the notion of number theoretical braid. Induced spinor fields are localized to the points of the braid defined by the flow lines of the Kähler magnetic field (or equivalently, any conserved current- this resolves the longstanding issue about the identification of number theoretical braids). The number of the included points depends on measurement resolution characterized somehow by the number rationals which are allowed. Only finite number of harmonics and sub-harmonics of  $L_0$  are possible so that for integer multiples the number of points is finite. If  $n_{max}L_0$  and  $L_0/n_{min}$  are the largest and smallest lengths involved, one can argue that the rationals  $n_{max}/n$ ,  $n = 1, \dots, n_{max}$  and  $n/n_{min}$ ,  $n = 1, \dots, n_{min}$  are the natural ones.

6. One can consider also algebraic extensions for which  $L_0$  is scaled from its reference value by an algebraic number so that the mass scale  $m$  must be scaled up in similar manner. The spectrum comes also now in integer multiples.  $p$ -Adic mass calculations predicts mass scales to the inverses of square roots of prime and this raises the expectation that  $\sqrt{n}$  harmonics and sub-harmonics of  $L_0$  might be necessary. Notice however that pseudo-momentum spectrum is in question so that this argument is on shaky grounds.

There is also the question about the allowed values of  $(\lambda_0, \lambda_3)$  for a given value of  $\lambda$ . This issue will be discussed in the next section devoted to the attempt to calculate the Dirac determinant assignable to this spectrum: suffice it to say that integer valued spectrum is the first guess implying that the pseudo-momenta satisfy  $n_0^2 - n_3^2 = n^2$  and therefore correspond to Pythagorean triangles. What is remarkable that the notion of number theoretic braid pops up automatically from the Beltrami flow hypothesis.

### 5.5.4 Hyper-octonionic primes

Before detailed discussion of the hyper-octonionic option it is good to consider the basic properties of hyper-octonionic primes.

1. Hyper-octonionic primes are of form

$$\Pi_p = (n_0, n_3, n_1, n_2, \dots, n_7) , \quad \Pi_p^2 = n_0^2 - \sum_i n_i^2 = p \text{ or } p^2 . \quad (5.5.30)$$

2. Hyper-octonionic primes have a standard representation as hyper-complex primes. The Minkowski norm squared factorizes into a product as

$$n_0^2 - n_3^2 = (n_0 + n_3)(n_0 - n_3) . \quad (5.5.31)$$

If one has  $n_3 \neq 0$ , the prime property implies  $n_0 - n_3 = 1$  so that one obtains  $n_0 = n_3 + 1$  and  $2n_3 + 1 = p$  giving

$$(n_0, n_3) = ((p+1)/2, (p-1)/2) . \quad (5.5.32)$$

Note that one has  $(p+1)/2$  odd for  $p \bmod 4 = 1$  and  $(p+1)/2$  even for  $p \bmod 4 = 3$ . The difference  $n_0 - n_3 = 1$  characterizes prime property.

If  $n_3$  vanishes the prime property implies equivalence with ordinary prime and one has  $n_0^2 = p^2$ . These hyper-octonionic primes represent particles at rest.

3. The action of a discrete subgroup  $G(p)$  of the octonionic automorphism group  $G_2$  generates form hyper-complex primes with  $n_3 \neq 0$  further hyper-octonionic primes  $\Pi(p, k)$  corresponding to the same value of  $n_0$  and  $p$  and for these the integer valued projection to  $M^2$  satisfies  $n_0^2 - n_3^2 = n > p$ . It is also possible to have a state representing the system at rest with  $(n_0, n_3) = ((p+1)/2, 0)$  so that the pseudo-mass varies in the range  $[\sqrt{p}, (p+1)/2]$ . The subgroup  $G(n_0, n_3) \subset SU(3)$  leaving invariant the projection  $(n_0, n_3)$  generates the hyper-octonionic primes corresponding to the same value of mass for hyper-octonionic primes with same Minkowskian length  $p$  and pseudo-mass  $\lambda = n \geq \sqrt{p}$ .
4. One obtains two kinds of primes corresponding to the lengths of pseudo-momenta equal to  $p$  or  $\sqrt{p}$ . The first kind of particles are always at rest whereas the second kind of particles can be brought at rest only if one interprets the pseudo-momentum as  $M^2$  projection. This brings in mind the secondary  $p$ -adic length scales assigned to causal diamonds ( $CDs$ ) and the primary  $p$ -adic lengths scales assigned to particles.

If the  $M^2$  projections of hyper-octonionic primes with length  $\sqrt{p}$  characterize the allowed basic momenta,  $\zeta_D$  is sum of zeta functions associated with various projections which must be in the limits dictated by the geometry of the orbit of the partonic surface giving upper and lower bounds  $L_{max}$  and  $L_{min}$  on the length  $L$ .  $L_{min}$  is scaled up to  $\sqrt{n_0^2 - n_3^2} L_{min}$  for a given projection  $(n_0, n_3)$ . In general a given  $M^2$  projection  $(n_0, n_3)$  corresponds to several hyper-octonionic primes since  $SU(3)$  rotations give a new hyper-octonionic prime with the same  $M^2$  projection. This leads to an inconsistency unless one has a good explanation for why some basic momentum can appear several times. One might argue that the spinor mode is degenerate due to the possibility to perform discrete color rotations of the state. For hyper complex representatives there is no such problem and it seems favored. In any case, one can look how the degeneracy factors for given projection can be calculated.

1. To calculate the degeneracy factor  $D(n)$  associated with given pseudo-mass value  $\lambda = n$  one must find all hyper-octonionic primes  $\Pi$ , which can have projection in  $M^2$  with length  $n$  and sum up the degeneracy factors  $D(n, p)$  associated with them:

$$\begin{aligned}
 D(n) &= \sum_p D(n, p) , \\
 D(n, p) &= \sum_{n_0^2 - n_3^2 = p} D(p, n_0, n_3) , \\
 n_0^2 - n_3^2 &= n , \quad \Pi_p^2(n_0, n_3) = n_0^2 - n_3^2 - \sum_i n_i^2 = n - \sum_i n_i^2 = p . \tag{5.5.33}
 \end{aligned}$$

2. The condition  $n_0^2 - n_3^2 = n$  allows only Pythagorean triangles and one must find the discrete subgroup  $G(n_0, n_3) \subset SU(3)$  producing hyper-octonions with integer valued components with length  $p$  and components  $(n_0, n_3)$ . The points at the orbit satisfy the condition

$$\sum n_i^2 = p - n . \tag{5.5.34}$$

The degeneracy factor  $D(p, n_0, n_3)$  associated with given mass value  $n$  is the number of elements of in the coset space  $G(n_0, n_3, p)/H(n_0, n_3, p)$ , where  $H(n_0, n_3, p)$  is the isotropy group of given hyper-octonionic prime obtained in this manner. For  $n_0^2 - n_3^2 = p^2$   $D(n_0, n_3, p)$  obviously equals to unity.

### 5.5.5 Three basic options for the pseudo-momentum spectrum

The calculation of the scaling factor of the Kähler function requires the knowledge of the degeneracies of the mass squared eigen values. There are three options to consider.

#### First option: all pseudo-momenta are allowed

If the degeneracy for pseudo-momenta in  $M^2$  is same for all mass values- and formally characterizable by a number  $N$  telling how many 2-D pseudo-momenta reside on mass shell  $n_0^2 - n_3^2 = m^2$ . In this case zeta function would be proportional to a sum of Riemann Zetas with scaled arguments corresponding to scalings of the basic mass  $m$  to  $m/q$ .

$$\zeta_D(s) = N \sum_q \zeta(\log(qx)s) , \quad x = \frac{L_{min}}{R} . \tag{5.5.35}$$

This option provides no idea about the possible values of  $1 \leq q \leq L_{max}/L_{min}$ . The number  $N$  is given by the integral of relativistic density of states  $\int dk/2\sqrt{k^2 + m^2}$  over the hyperbola and is logarithmically divergent so that the normalization factor  $N$  of the Kähler function would be infinite.

### Second option: All integer valued pseudomomenta are allowed

Second option is inspired by number theoretic vision and assumes integer valued components for the momenta using  $m_{max} = 2\pi/L_{min}$  as mass unit. p-Adicization motivates also the assumption that momentum components using  $m_{max}$  as mass scale are integers. This would restrict the choice of the number theoretical braids.

Integer valuedness together with masses coming as integer multiples of  $m_{max}$  implies  $(\lambda_0, \lambda_3) = (n_0, n_3)$  with on mass shell condition  $n_0^2 - n_3^2 = n^2$ . Note that the condition is invariant under scaling. These integers correspond to Pythagorean triangles plus the degenerate situation with  $n_3 = 0$ . There exists a finite number of pairs  $(n_0, n_3)$  satisfying this condition as one finds by expressing  $n_0$  as  $n_0 = n_3 + k$  giving  $2n_3k + k^2 = p^2$  giving  $n_3 < n^2/2, n_0 < n^2/2 + 1$ . This would be enough to have a finite degeneracy  $D(n) \geq 1$  for a given value of mass squared and  $\zeta_D$  would be well defined.  $\zeta_D$  would be a modification of Riemann zeta given by

$$\begin{aligned}\zeta_D &= \sum_q \zeta_1(\log(qx)s) , \quad x = \frac{L_{min}}{R} , \\ \zeta_1(s) &= \sum g_n n^{-s} , \quad g_n \geq 1 .\end{aligned}\tag{5.5.36}$$

For generalized Feynman diagrams this option allows conservation of pseudo-momentum and for loops no divergences are possible since the integral over two-dimensional virtual momenta is replaced with a sum over discrete mass shells containing only a finite number of points. This option looks thus attractive but requires a regularization. On the other hand, the appearance of a zeta function having a strong resemblance with Riemann zeta could explain the finding that Riemann zeta is closely related to the description of critical systems. This point will be discussed later.

### Third option: Infinite primes code for the allowed mass scales

According to the proposal of [?] , [?] the hyper-complex parts of hyper-octonionic primes appearing in their infinite counterparts correspond to the  $M^2$  projections of real four-momenta. This hypothesis suggests a very detailed map between infinite primes and standard model quantum numbers and predicts a universal mass spectrum [?] . Since pseudo-momenta are automatically restricted to the plane  $M^2$ , one cannot avoid the question whether they could actually correspond to the hyper-octonionic primes defining the infinite prime. These interpretations need not of course exclude each other. This option allows several variants and at this stage it is not possible to exclude any of these options.

1. One must choose between two alternatives for which pseudo-momentum corresponds to hyper-complex prime serving as a canonical representative of a hyper-octonionic prime or a projection of hyper-octonionic prime to  $M^2$ .
2. One must decide whether one allows a) only the momenta corresponding to hyper-complex primes, b) also their powers (p-adic fractality), or c) all their integer multiples ("Riemann option").

One must also decide what hyper-octonionic primes are allowed.

1. The first guess is that all hyper-complex/hyper-octonionic primes defining length scale  $\sqrt{p}L_{min} \leq L_{max}$  or  $pL_{min} \leq L_{max}$  are allowed. p-Adic fractality suggests that also the higher p-adic length scales  $p^{n/2}L_{min} < L_{max}$  and  $p^n L_{min} < L_{max}$ ,  $n \geq 1$ , are possible.

It can however happen that no primes are allowed by this criterion. This would mean vanishing Kähler function which is of course also possible since Kähler action can vanish (for instance, for massless extremals). It seems therefore safer to allow also the scale corresponding to the trivial prime  $(n_0, n_3) = (1, 0)$  (1 is formally prime because it is not divisible by any prime different from 1) so that at least  $L_{min}$  is possible. This option also allows only rather small primes unless the partonic 2-surface contains vacuum regions in which case  $L_{max}$  is infinite: in this case all primes would be allowed and the exponent of Kähler function would vanish.

2. The hypothesis that only the hyper-complex or hyper-octonionic primes appearing in the infinite hyper-octonionic prime are possible looks more reasonable since large values of  $p$  would be possible and could be identified in terms of the  $p$ -adic length scale hypothesis. All hyper-octonionic primes appearing in infinite prime would be possible and the geometry of the orbit of the partonic 2-surface would define an infinite prime. This would also give a concrete physical interpretation for the earlier hypothesis that hyper-octonionic primes appearing in the infinite prime characterize partonic 2-surfaces geometrically. One can also identify the fermionic and purely bosonic primes appearing in the infinite prime as braid strands carrying fermion number and purely bosonic quantum numbers. This option will be assumed in the following.

## 5.6 How to define generalized Feynman diagrams?

S-matrix codes to a high degree the predictions of quantum theories. The longstanding challenge of TGD has been to construct or at least demonstrate the mathematical existence of S-matrix- or actually M-matrix which generalizes this notion in zero energy ontology (ZEO) [K61]. This work has led to the notion of generalized Feynman diagram and the challenge is to give a precise mathematical meaning for this object. The attempt to understand the counterpart of twistors in TGD framework [?] has inspired several key ideas in this respect but it turned out that twistors themselves need not be absolutely necessary in TGD framework.

1. The notion of generalized Feynman diagram defined by replacing lines of ordinary Feynman diagram with light-like 3-surfaces (elementary particle sized wormhole contacts with throats carrying quantum numbers) and vertices identified as their 2-D ends - I call them partonic 2-surfaces is central. Speaking somewhat loosely, generalized Feynman diagrams (plus background space-time sheets) define the "world of classical worlds" (WCW). These diagrams involve the analogs of stringy diagrams but the interpretation is different: the analogs of stringy loop diagrams have interpretation in terms of particle propagating via two different routes simultaneously (as in the classical double slit experiment) rather than as a decay of particle to two particles. For stringy diagrams the counterparts of vertices are singular as manifolds whereas the entire diagrams are smooth. For generalized Feynman diagrams vertices are smooth but entire diagrams represent singular manifolds just like ordinary Feynman diagrams do. String like objects however emerge in TGD and even ordinary elementary particles are predicted to be magnetic flux tubes of length of order weak gauge boson Compton length with monopoles at their ends as shown in accompanying article. This stringy character should become visible at LHC energies.
2. Zero energy ontology (ZEO) and causal diamonds (intersections of future and past directed lightcones) is second key ingredient. The crucial observation is that in ZEO it is possible to identify off mass shell particles as pairs of on mass shell particles at throats of wormhole contact since both positive and negative signs of energy are possible. The propagator defined by modified Dirac action does not diverge (except for incoming lines) although the fermions at throats are on mass shell. In other words, the generalized eigenvalue of the modified Dirac operator containing a term linear in momentum is non-vanishing and propagator reduces to  $G = i/\lambda\gamma$ , where  $\gamma$  is so called modified gamma matrix in the direction of stringy coordinate [K15]. This means opening of the black box of the off mass shell particle-something which for some reason has not occurred to anyone fighting with the divergences of quantum field theories.
3. A powerful constraint is number theoretic universality requiring the existence of Feynman amplitudes in all number fields when one allows suitable algebraic extensions: roots of unity are certainly required in order to realize  $p$ -adic counter parts of plane waves. Also imbedding space, partonic 2-surfaces and WCW must exist in all number fields and their extensions. These constraints are enormously powerful and the attempts to realize this vision have dominated quantum TGD for last two decades.
4. Representation of 8-D gamma matrices in terms of octonionic units and 2-D sigma matrices is a further important element as far as twistors are considered [?]. Modified gamma matrices at space-time surfaces are quaternionic/associative and allow a genuine matrix representation. As a matter fact, TGD and WCW can be formulated as study of associative local sub-algebras of the local Clifford algebra of 8-D imbedding space parameterized by quaternionic space-time

surfaces. Central conjecture is that quaternionic 4-surfaces correspond to preferred extremals of Kähler action [K15] identified as critical ones (second variation of Kähler action vanishes for infinite number of deformations defining super-conformal algebra) and allow a slicing to string worldsheets parametrized by points of partonic 2-surfaces.

5. As far as twistors are considered, the first key element is the reduction of the octonionic twistor structure to quaternionic one at space-time surfaces and giving effectively 4-D spinor and twistor structure for quaternionic surfaces.

Quite recently quite a dramatic progress took place in this approach [?, ?] .

1. The progress was stimulated by the simple observation that on mass shell property puts enormously strong kinematic restrictions on the loop integrations. With mild restrictions on the number of parallel fermion lines appearing in vertices (there can be several since fermionic oscillator operator algebra defining SUSY algebra generates the parton states)- all loops are manifestly finite and if particles has always mass -say small  $p$ -adic thermal mass also in case of massless particles and due to IR cutoff due to the presence largest CD- the number of diagrams is finite. Unitarity reduces to Cutkosky rules [?] automatically satisfied as in the case of ordinary Feynman diagrams.
2. Ironically, twistors which stimulated all these development do not seem to be absolutely necessary in this approach although they are of course possible. Situation changes if one does not assume small  $p$ -adically thermal mass due to the presence of massless particles and one must sum infinite number of diagrams. Here a potential problem is whether the infinite sum respects the algebraic extension in question.

This is about fermionic and momentum space aspects of Feynman diagrams but not yet about the functional (not path-) integral over small deformations of the partonic 2-surfaces. The basic challenges are following.

1. One should perform the functional integral over WCW degrees of freedom for fixed values of on mass shell momenta appearing in the internal lines. After this one must perform integral or summation over loop momenta. Note that the order is important since the space-time surface assigned to the line carries information about the quantum numbers associated with the line by quantum classical correspondence realized in terms of modified Dirac operator.
2. One must define the functional integral also in the  $p$ -adic context.  $p$ -Adic Fourier analysis relying on algebraic continuation raises hopes in this respect.  $p$ -Adicity suggests strongly that the loop momenta are discretized and ZEO predicts this kind of discretization naturally.

It indeed seems that the functional integrals over WCW could be carried out at general level both in real and  $p$ -adic context. This is due to the symmetric space property (maximal number of isometries) of WCW required by the mere mathematical existence of Kähler geometry [?] in infinite-dimensional context already in the case of much simpler loop spaces [?] .

1. The  $p$ -adic generalization of Fourier analysis allows to algebraize integration- the horrible looking technical challenge of  $p$ -adic physics- for symmetric spaces for functions allowing the analog of discrete Fourier decomposition. Symmetric space property is indeed essential also for the existence of Kähler geometry for infinite-D spaces as was learned already from the case of loop spaces. Plane waves and exponential functions expressible as roots of unity and powers of  $p$  multiplied by the direct analogs of corresponding exponent functions are the basic building bricks and key functions in harmonic analysis in symmetric spaces. The physically unavoidable finite measurement resolution corresponds to algebraically unavoidable finite algebraic dimension of algebraic extension of  $p$ -adics (at least some roots of unity are needed). The cutoff in roots of unity is very reminiscent to that occurring for the representations of quantum groups and is certainly very closely related to these as also to the inclusions of hyper-finite factors of type II<sub>sub $\zeta$</sub>  defining the finite measurement resolution.

2. WCW geometrization reduces to that for a single line of the generalized Feynman diagram defining the basic building brick for WCW. Kähler function decomposes to a sum of "kinetic" terms associated with its ends and interaction term associated with the line itself. p-Adicization boils down to the condition that Kähler function, matrix elements of Kähler form, WCW Hamiltonians and their super counterparts, are rational functions of complex WCW coordinates just as they are for those symmetric spaces that I know of. This allows straightforward continuation to p-adic context.
3. As far as diagrams are considered, everything is manifestly finite as the general arguments (non-locality of Kähler function as functional of 3-surface) developed two decades ago indeed allow to expect. General conditions on the holomorphy properties of the generalized eigenvalues  $\lambda$  of the modified Dirac operator can be deduced from the conditions that propagator decomposes to a sum of products of harmonics associated with the ends of the line and that similar decomposition takes place for exponent of Kähler action identified as Dirac determinant. This guarantees that the convolutions of propagators and vertices give rise to products of harmonic functions which can be Glebsch-Gordanized to harmonics and only the singlet contributes to the WCW integral in given vertex. The still unproven central conjecture is that Dirac determinant equals the exponent of Kähler function.

In the following this vision about generalized Feynman diagrams is discussed in more detail.

### 5.6.1 Questions

The goal is a proposal for how to perform the integral over WCW for generalized Feynman digrams and the best manner to proceed to to this goal is by making questions.

#### What does finite measurement resolution mean?

The first question is what finite measurement resolution means.

1. One expects that the algebraic continuation makes sense only for a finite measurement resolution in which case one obtains only finite sums of what one might hope to be algebraic functions. The finiteness of the algebraic extension would be in fact equivalent with the finite measurement resolution.
2. Finite measurement resolution means a discretization in terms of number theoretic braids. p-Adicization condition suggests that that one must allow only the number theoretic braids. For these the ends of braid at boundary of  $CD$  are algebraic points of the imbedding space. This would be true at least in the intersection of real and p-adic worlds.
3. The question is whether one can localize the points of the braid. The necessity to use momentum eigenstates to achieve quantum classical correspondence in the modified Dirac action [K15] suggests however a delocalization of braid points, that is wave function in space of braid points. In real context one could allow all possible choices for braid points but in p-adic context only algebraic points are possible if one wants to replace integrals with sums. This implies finite measurement resolution analogous to that in lattice. This is also the only possibility in the intersection of real and p-adic worlds.

A non-trivial prediction giving a strong correlation between the geometry of the partonic 2-surface and quantum numbers is that the total number  $n_F + n_{\bar{F}}$  of fermions and antifermions is bounded above by the number  $n_{alg}$  of algebraic points for a given partonic 2-surface:  $n_F + n_{\bar{F}} \leq n_{alg}$ . Outside the intersection of real and p-adic worlds the problematic aspect of this definition is that small deformations of the partonic 2-surface can radically change the number of algebraic points unless one assumes that the finite measurement resolution means restriction of WCW to a sub-space of algebraic partonic surfaces.

4. One has also a discretization of loop momenta if one assumes that virtual particle momentum corresponds to ZEO defining rest frame for it and from the discretization of the relative position of the second tip of  $CD$  at the hyperboloid isometric with mass shell. Only the number of braid points and their momenta would matter, not their positions. The measurement interaction term

in the modified Dirac action gives coupling to the space-time geometry and Kähler function through generalized eigenvalues of the modified Dirac operator with measurement interaction term linear in momentum and in the color quantum numbers assignable to fermions [K15].

### How to define integration in WCW degrees of freedom?

The basic question is how to define the integration over WCW degrees of freedom.

1. What comes mind first is Gaussian perturbation theory around the maxima of Kähler function. Gaussian and metric determinants cancel each other and only algebraic expressions remain. Finiteness is not a problem since the Kähler function is non-local functional of 3-surface so that no local interaction vertices are present. One should however assume the vanishing of loops required also by algebraic universality and this assumption look unrealistic when one considers more general functional integrals than that of vacuum functional since free field theory is not in question. The construction of the inverse of the WCW metric defining the propagator is also a very difficult challenge. Duistermaat-Hecke theorem states that something like this known as localization might be possible and one can also argue that something analogous to localization results from a generalization of mean value theorem.
2. Symmetric space property is more promising since it might reduce the integrations to group theory using the generalization of Fourier analysis for group representations so that there would be no need for perturbation theory in the proposed sense. In finite measurement resolution the symmetric spaces involved would be finite-dimensional. Symmetric space structure of WCW could also allow to define p-adic integration in terms of p-adic Fourier analysis for symmetric spaces. Essentially algebraic continuation of the integration from the real case would be in question with additional constraints coming from the fact that only phase factors corresponding to finite algebraic extensions of rationals are used. Cutoff would emerge automatically from the cutoff for the dimension of the algebraic extension.

### How to define generalized Feynman diagrams?

Integration in symmetric spaces could serve as a model at the level of WCW and allow both the understanding of WCW integration and p-adicization as algebraic continuation. In order to get a more realistic view about the problem one must define more precisely what the calculation of the generalized Feynman diagrams means.

1. WCW integration must be carried out separately for all values of the momenta associated with the internal lines. The reason is that the spectrum of eigenvalues  $\lambda_i$  of the modified Dirac operator  $D$  depends on the momentum of line and momentum conservation in vertices translates to a correlation of the spectra of  $D$  at internal lines.
2. For tree diagrams algebraic continuation to the p-adic context if the expression involves only the replacement of the generalized eigenvalues of  $D$  as functions of momenta with their p-adic counterparts besides vertices. If these functions are algebraically universal and expressible in terms of harmonics of symmetric space, there should be no problems.
3. If loops are involved, one must integrate/sum over loop momenta. In p-adic context difficulties are encountered if the spectrum of the momenta is continuous. The integration over on mass shell loop momenta is analogous to the integration over sub-CDs, which suggests that internal line corresponds to a *sub-CD* in which it is at rest. There are excellent reasons to believe that the moduli space for the positions of the upper tip is a discrete subset of hyperboloid of future light-cone. If this is the case, the loop integration indeed reduces to a sum over discrete positions of the tip. p-Adicization would thus give a further good reason why for zero energy ontology.
4. Propagator is expressible in terms of the inverse of generalized eigenvalue and there is a sum over these for each propagator line. At vertices one has products of WCW harmonics assignable to the incoming lines. The product must have vanishing quantum numbers associated with the phase angle variables of WCW. Non-trivial quantum numbers of the WCW harmonic correspond



to WCW quantum numbers assignable to excitations of ordinary elementary particles. WCW harmonics are products of functions depending on the "radial" coordinates and phase factors and the integral over the angles leaves the product of the first ones analogous to Legendre polynomials  $P_{l,m}$ . These functions are expected to be rational functions or at least algebraic functions involving only square roots.

5. In ordinary QFT incoming and outgoing lines correspond to propagator poles. In the recent case this would mean that the generalized eigenvalues  $\lambda = 0$  characterize them. Internal lines coming as pairs of throats of wormhole contacts would be on mass shell with respect to momentum but off shell with respect to  $\lambda$ .

### 5.6.2 Generalized Feynman diagrams at fermionic and momentum space level

Negative energy ontology has already led to the idea of interpreting the virtual particles as pairs of positive and negative energy wormhole throats. Hitherto I have taken it as granted that ordinary Feynman diagrammatics generalizes more or less as such. It is however far from clear what really happens in the vertices of the generalized Feynmann diagrams. The safest approach relies on the requirement that unitarity realized in terms of Cutkosky rules in ordinary Feynman diagrammatics allows a generalization. This requires loop diagrams. In particular, photon-photon scattering can take place only via a fermionic square loop so that it seems that loops must be present at least in the topological sense.

One must be however ready for the possibility that something unexpectedly simple might emerge. For instance, the vision about algebraic physics allows naturally only finite sums for diagrams and does not favor infinite perturbative expansions. Hence the true believer on algebraic physics might dream about finite number of diagrams for a given reaction type. For simplicity generalized Feynman diagrams without the complications brought by the magnetic confinement since by the previous arguments the generalization need not bring in anything essentially new.

The basic idea of duality in early hadronic models was that the lines of the dual diagram representing particles are only re-arranged in the vertices. This however does not allow to get rid of off mass shell momenta. Zero energy ontology encourages to consider a stronger form of this principle in the sense that the virtual momenta of particles could correspond to pairs of on mass shell momenta of particles. If also interacting fermions are pairs of positive and negative energy throats in the interaction region the idea about reducing the construction of Feynman diagrams to some kind of lego rules might work.

#### Virtual particles as pairs of on mass shell particles in ZEO

The first thing is to try to define more precisely what generalized Feynman diagrams are. The direct generalization of Feynman diagrams implies that both wormhole throats and wormhole contacts join at vertices.

1. A simple intuitive picture about what happens is provided by diagrams obtained by replacing the points of Feynman diagrams (wormhole contacts) with short lines and imagining that the throats correspond to the ends of the line. At vertices where the lines meet the incoming on mass shell quantum numbers would sum up to zero. This approach leads to a straightforward generalization of Feynman diagrams with virtual particles replaced with pairs of on mass shell throat states of type  $++$ ,  $--$ , and  $+-$ . Incoming lines correspond to  $++$  type lines and outgoing ones to  $--$  type lines. The first two line pairs allow only time like net momenta whereas  $+-$  line pairs allow also space-like virtual momenta. The sign assigned to a given throat is dictated by the the sign of the on mass shell momentum on the line. The condition that Cutkosky rules generalize as such requires  $++$  and  $--$  type virtual lines since the cut of the diagram in Cutkosky rules corresponds to on mass shell outgoing or incoming states and must therefore correspond to  $++$  or  $--$  type lines.
2. The basic difference as compared to the ordinary Feynman diagrammatics is that loop integrals are integrals over mass shell momenta and that all throats carry on mass shell momenta. In each vertex of the loop mass incoming on mass shell momenta must sum up to on mass shell

momentum. These constraints improve the behavior of loop integrals dramatically and give excellent hopes about finiteness. It does not however seem that only a finite number of diagrams contribute to the scattering amplitude besides tree diagrams. The point is that if a the reactions  $N_1 \rightarrow N_2$  and  $N_2 \rightarrow N_3$ , where  $N_i$  denote particle numbers, are possible in a common kinematical region for  $N_2$ -particle states then also the diagrams  $N_1 \rightarrow N_2 \rightarrow N_2 \rightarrow N_3$  are possible. The virtual states  $N_2$  include all states in the intersection of kinematically allow regions for  $N_1 \rightarrow N_2$  and  $N_2 \rightarrow N_3$ . Hence the dream about finite number possible diagrams is not fulfilled if one allows massless particles. If all particles are massive then the particle number  $N_2$  for given  $N_1$  is limited from above and the dream is realized.

3. For instance, loops are not possible in the massless case or are highly singular (bringing in mind twistor diagrams) since the conservation laws at vertices imply that the momenta are parallel. In the massive case and allowing mass spectrum the situation is not so simple. As a first example one can consider a loop with three vertices and thus three internal lines. Three on mass shell conditions are present so that the four-momentum can vary in 1-D subspace only. For a loop involving four vertices there are four internal lines and four mass shell conditions so that loop integrals would reduce to discrete sums. Loops involving more than four vertices are expected to be impossible.
4. The proposed replacement of the elementary fermions with bound states of elementary fermions and monopoles  $X_{\pm}$  brings in the analog of stringy diagrammatics. The 2-particle wave functions in the momentum degrees of freedom of fermions and  $X_{\pm}$  might allow more flexibility and allow more loops. Note however that there are excellent hopes about the finiteness of the theory also in this case.

### Loop integrals are manifestly finite

One can make also more detailed observations about loops.

1. The simplest situation is obtained if only 3-vertices are allowed. In this case conservation of momentum however allows only collinear momenta although the signs of energy need not be the same. Particle creation and annihilation is possible and momentum exchange is possible but is always light-like in the massless case. The scattering matrices of supersymmetric YM theories would suggest something less trivial and this raises the question whether something is missing. Magnetic monopoles are an essential element of also these theories as also massivation and symmetry breaking and this encourages to think that the formation of massive states as fermion  $X_{\pm}$  pairs is needed. Of course, in TGD framework one has also high mass excitations of the massless states making the scattering matrix non-trivial.
2. In YM theories on mass shell lines would be singular. In TGD framework this is not the case since the propagator is defined as the inverse of the 3-D dimensional reduction of the modified Dirac operator  $D$  containing also coupling to four-momentum (this is required by quantum classical correspondence and guarantees stringy propagators),

$$\begin{aligned} D &= i\hat{\Gamma}^{\alpha}p_{\alpha} + \hat{\Gamma}^{\alpha}D_{\alpha} \ , \\ p_{\alpha} &= p_k\partial_{\alpha}h^k \ . \end{aligned} \tag{5.6.1}$$

The propagator does not diverge for on mass shell massless momenta and the propagator lines are well-defined. This is of course of essential importance also in general case. Only for the incoming lines one can consider the possibility that 3-D Dirac operator annihilates the induced spinor fields. All lines correspond to generalized eigenstates of the propagator in the sense that one has  $D_3\Psi = \lambda\gamma\Psi$ , where  $\gamma$  is modified gamma matrix in the direction of the stringy coordinate emanating from light-like surface and  $D_3$  is the 3-dimensional dimensional reduction of the 4-D modified Dirac operator. The eigenvalue  $\lambda$  is analogous to energy. Note that the eigenvalue spectrum depends on 4-momentum as a parameter.

3. Massless incoming momenta can decay to massless momenta with both signs of energy. The integration measure  $d^2k/2E$  reduces to  $dx/x$  where  $x \geq 0$  is the scaling factor of massless momentum. Only light-like momentum exchanges are however possible and scattering matrix is essentially trivial. The loop integrals are finite apart from the possible delicacies related to poles since the loop integrands for given massless wormhole contact are proportional to  $dx/x^3$  for large values of  $x$ .
4. Irrespective of whether the particles are massless or not, the divergences are obtained only if one allows too high vertices as self energy loops for which the number of momentum degrees of freedom is  $3N - 4$  for  $N$ -vertex. The construction of SUSY limit of TGD in [?] led to the conclusion that the parallelly propagating  $N$  fermions for given wormhole throat correspond to a product of  $N$  fermion propagators with same four-momentum so that for fermions and ordinary bosons one has the standard behavior but for  $N > 2$  non-standard so that these excitations are not seen as ordinary particles. Higher vertices are finite only if the total number  $N_F$  of fermions propagating in the loop satisfies  $N_F > 3N - 4$ . For instance, a 4-vertex from which  $N = 2$  states emanate is finite.

### Taking into account magnetic confinement

What has been said above is not quite enough. The weak form of electric-magnetic duality [?] leads to the picture about elementary particles as pairs of magnetic monopoles inspiring the notions of weak confinement based on magnetic monopole force. Also color confinement would have magnetic counterpart. This means that elementary particles would behave like string like objects in weak boson length scale. Therefore one must also consider the stringy case with wormhole throats replaced with fermion- $X_{\pm}$  pairs ( $X_{\pm}$  is electromagnetically neutral and  $\pm$  refers to the sign of the weak isospin opposite to that of fermion) and their super partners.

1. The simplest assumption in the stringy case is that fermion- $X_{\pm}$  pairs behave as coherent objects, that is scatter elastically. In more general case only their higher excitations identifiable in terms of stringy degrees of freedom would be created in vertices. The massivation of these states makes possible non-collinear vertices. An open question is how the massivation fermion- $X_{\pm}$  pairs relates to the existing TGD based description of massivation in terms of Higgs mechanism and modified Dirac operator.
2. Mass renormalization could come from self energy loops with negative energy lines as also vertex normalization. By very general arguments supersymmetry implies the cancellation of the self energy loops but would allow non-trivial vertex renormalization [?] .
3. If only 3-vertices are allowed, the loops containing only positive energy lines are possible if on mass shell fermion- $X_{\pm}$  pair (or its superpartner) can decay to a pair of positive energy pair particles of same kind. Whether this is possible depends on the masses involved. For ordinary particles these decays are not kinematically possible below intermediate boson mass scale (the decays  $F_1 \rightarrow F_2 + \gamma$  are forbidden kinematically or by the absence of flavor changing neutral currents whereas intermediate gauge bosons can decay to on mass shell fermion-antifermion pair).
4. The introduction of IR cutoff for 3-momentum in the rest system associated with the largest  $CD$  (causal diamond) looks natural as scale parameter of coupling constant evolution and p-adic length scale hypothesis favors the inverse of the size scale of  $CD$  coming in powers of two. This parameter would define the momentum resolution as a discrete parameter of the p-adic coupling constant evolution. This scale does not have any counterpart in standard physics. For electron,  $d$  quark, and  $u$  quark the proper time distance between the tips of  $CD$  corresponds to frequency of 10 Hz, 1280 Hz, and 160 Hz: all these frequencies define fundamental bio-rhythms [K22] .

These considerations have left completely untouched one important aspect of generalized Feynman diagrams: the necessity to perform a functional integral over the deformations of the partonic 2-surfaces at the ends of the lines- that is integration over WCW. Number theoretical universality requires that WCW and these integrals make sense also p-adically and in the following these aspects of generalized Feynman diagrams are discussed.

### 5.6.3 Harmonic analysis in WCW as a manner to calculate WCW functional integrals

Previous examples suggest that symmetric space property, Kähler and symplectic structure and the use of symplectic coordinates consisting of canonically conjugate pairs of phase angles and corresponding "radial" coordinates are essential for WCW integration and p-adicization. Kähler function, the components of the metric, and therefore also metric determinant and Kähler function depend on the "radial" coordinates only and the possible generalization involves the identification the counterparts of the "radial" coordinates in the case of WCW.

#### Conditions guaranteeing the reduction to harmonic analysis

The basic idea is that harmonic analysis in symmetric space allows to calculate the functional integral over WCW.

1. Each propagator line corresponds to a symmetric space defined as a coset space  $G/H$  of the symplectic group and Kac-Moody group and one might hope that the proposed p-adicization works for it- at least when one considers the hierarchy of measurement resolutions forced by the finiteness of algebraic extensions. This coset space is as a manifold Cartesian product  $(G/H) \times (G/H)$  of symmetric spaces  $G/H$  associated with ends of the line. Kähler metric contains also an interaction term between the factors of the Cartesian product so that Kähler function can be said to reduce to a sum of "kinetic" terms and interaction term.
2. Effective 2-dimensionality and ZEO allow to treat the ends of the propagator line independently. This means an enormous simplification. Each line contributes besides propagator a piece to the exponent of Kähler action identifiable as interaction term in action and depending on the propagator momentum. This contribution should be expressible in terms of generalized spherical harmonics. Essentially a sum over the products of pairs of harmonics associated with the ends of the line multiplied by coefficients analogous to  $1/(p^2 - m^2)$  in the case of the ordinary propagator would be in question. The optimal situation is that the pairs are harmonics and their conjugates appear so that one has invariance under  $G$  analogous to momentum conservation for the lines of ordinary Feynman diagrams.
3. Momentum conservation correlates the eigenvalue spectra of the modified Dirac operator  $D$  at propagator lines [K15] .  $G$ -invariance at vertex dictates the vertex as the singlet part of the product of WCW harmonics associated with the vertex and one sums over the harmonics for each internal line. p-Adicization means only the algebraic continuation to real formulas to p-adic context.
4. The exponent of Kähler function depends on both ends of the line and this means that the geometries at the ends are correlated in the sense that that Kähler form contains interaction terms between the line ends. It is however not quite clear whether it contains separate "kinetic" or self interaction terms assignable to the line ends. For Kähler function the kinetic and interaction terms should have the following general expressions as functions of complex WCW coordinates:

$$\begin{aligned}
 K_{kin,i} &= \sum_n f_{i,n}(Z_i) \overline{f_{i,n}(Z_i)} + c.c. , \\
 K_{int} &= \sum_n g_{1,n}(Z_1) \overline{g_{2,n}(Z_2)} + c.c. , i = 1, 2 .
 \end{aligned}
 \tag{5.6.2}$$

Here  $K_{kin,i}$  define "kinetic" terms and  $K_{int}$  defines interaction term. One would have what might be called holomorphic factorization suggesting a connection with conformal field theories.

Symmetric space property -that is isometry invariance- suggests that one has

$$f_{i,n} = f_{2,n} \equiv f_n , \quad g_{1,n} = g_{2,n} \equiv g_n
 \tag{5.6.3}$$

such that the products are invariant under the group  $H$  appearing in  $G/H$  and therefore have opposite  $H$  quantum numbers. The exponent of Kähler function does not factorize although the terms in its Taylor expansion factorize to products whose factors are products of holomorphic and antiholomorphic functions.

5. If one assumes that the exponent of Kähler function reduces to a product of eigenvalues of the modified Dirac operator eigenvalues must have the decomposition

$$\lambda_k = \prod_{i=1,2} \exp \left[ \sum_n c_{k,n} g_n(Z_i) \overline{g_n(Z_i)} + c.c \right] \times \exp \left[ \sum_n d_{k,n} g_n(Z_1) \overline{g_n(Z_2)} + c.c \right] \quad (5.6.4)$$

Hence also the eigenvalues coming from the Dirac propagators have also expansion in terms of  $G/H$  harmonics so that in principle WCW integration would reduce to Fourier analysis in symmetric space.

### Generalization of WCW Hamiltonians

This picture requires a generalization of the view about configuration space Hamiltonians since also the interaction term between the ends of the line is present not taken into account in the previous approach.

1. The proposed representation of WCW Hamiltonians as flux Hamiltonians [?, K15]

$$\begin{aligned} Q(H_A) &= \int H_A (1 + K) J d^2 x , \\ J &= \epsilon^{\alpha\beta} J_{\alpha\beta} , \quad J^{03} \sqrt{g_4} = K J_{12} . \end{aligned} \quad (5.6.5)$$

works for the kinetic terms only since  $J$  cannot be the same at the ends of the line. The formula defining  $K$  assumes weak form of self-duality (<sup>03</sup> refers to the coordinates in the complement of  $X^2$  tangent plane in the 4-D tangent plane).  $K$  is assumed to be symplectic invariant and constant for given  $X^2$ . The condition that the flux of  $F^{03} = (\hbar/g_K) J^{03}$  defining the counterpart of Kähler electric field equals to the Kähler charge  $g_K$  gives the condition  $K = g_K^2/\hbar$ , where  $g_K$  is Kähler coupling constant. Within experimental uncertainties one has  $\alpha_K = g_K^2/4\pi\hbar_0 = \alpha_{em} \simeq 1/137$ , where  $\alpha_{em}$  is finite structure constant in electron length scale and  $\hbar_0$  is the standard value of Planck constant.

The assumption that Poisson bracket of WCW Hamiltonians reduces to the level of imbedding space - in other words  $\{Q(H_A), Q(H_B)\} = Q(\{H_A, H_B\})$  - can be justified. One starts from the representation in terms of say flux Hamiltonians  $Q(H_A)$  and defines  $J_{A,B}$  as  $J_{A,B} \equiv Q(\{H_A, H_B\})$ . One has  $\partial H_A / \partial t_B = \{H_B, H_A\}$ , where  $t_B$  is the parameter associated with the exponentiation of  $H_B$ . The inverse  $J^{AB}$  of  $J_{A,B} = \partial H_B / \partial t_A$  is expressible as  $J^{A,B} = \partial t_A / \partial H_B$ . From these formulas one can deduce by using chain rule that the bracket  $\{Q(H_A), Q(H_B)\} = \partial t_C Q(H_A) J^{CD} \partial t_D Q(H_B)$  of flux Hamiltonians equals to the flux Hamiltonian  $Q(\{H_A, H_B\})$ .

2. One should be able to assign to WCW Hamiltonians also a part corresponding to the interaction term. The symplectic conjugation associated with the interaction term permutes the WCW coordinates assignable to the ends of the line. One should reduce this apparently non-local symplectic conjugation (if one thinks the ends of line as separate objects) to a non-local symplectic conjugation for  $\delta CD \times CP_2$  by identifying the points of lower and upper end of  $CD$  related by time reflection and assuming that conjugation corresponds to time reflection. Formally this gives a well defined generalization of the local Poisson brackets between time reflected points at the boundaries of  $CD$ . The connection of Hermitian conjugation and time reflection in quantum field theories is in accordance with this picture.

3. The only manner to proceed is to assign to the flux Hamiltonian also a part obtained by the replacement of the flux integral over  $X^2$  with an integral over the projection of  $X^2$  to a sphere  $S^2$  assignable to the light-cone boundary or to a geodesic sphere of  $CP_2$ , which come as two varieties corresponding to homologically trivial and non-trivial spheres. The projection is defined as by the geodesic line orthogonal to  $S^2$  and going through the point of  $X^2$ . The hierarchy of Planck constants assigns to  $CD$  a preferred geodesic sphere of  $CP_2$  as well as a unique sphere  $S^2$  as a sphere for which the radial coordinate  $r_M$  or the light-cone boundary defined uniquely is constant: this radial coordinate corresponds to spherical coordinate in the rest system defined by the time-like vector connecting the tips of  $CD$ . Either spheres or possibly both of them could be relevant.

Recall that also the construction of number theoretic braids and symplectic QFT [K17] led to the proposal that braid diagrams and symplectic triangulations could be defined in terms of projections of braid strands to one of these spheres. One could also consider a weakening for the condition that the points of the number theoretic braid are algebraic by requiring only that the  $S^2$  coordinates of the projection are algebraic and that these coordinates correspond to the discretization of  $S^2$  in terms of the phase angles associated with  $\theta$  and  $\phi$ .

This gives for the corresponding contribution of the WCW Hamiltonian the expression

$$Q(H_A)_{int} = \int_{S^2_{\pm}} H_A X \delta^2(s_+, s_-) d^2 s_{\pm} = \int_{P(X^2_{\pm}) \cap P(X^2)} \frac{\partial(s^1, s^2)}{\partial(x^1_{\pm}, x^2_{\pm})} d^2 x_{\pm} . \quad (5.6.6)$$

Here the Poisson brackets between ends of the line using the rules involve delta function  $\delta^2(s_+, s_-)$  at  $S^2$  and the resulting Hamiltonians can be expressed as a similar integral of  $H_{[A,B]}$  over the upper or lower end since the integral is over the intersection of  $S^2$  projections.

The expression must vanish when the induced Kähler form vanishes for either end. This is achieved by identifying the scalar  $X$  in the following manner:

$$\begin{aligned} X &= J_+^{kl} J_{kl}^- , \\ J_{\pm}^{kl} &= (1 + K_{\pm}) \partial_{\alpha} s^k \partial_{\beta} s^l J_{\pm}^{\alpha\beta} . \end{aligned} \quad (5.6.7)$$

The tensors are lifts of the induced Kähler form of  $X^2_{\pm}$  to  $S^2$  (not  $CP_2$ ).

4. One could of course ask why these Hamiltonians could not contribute also to the kinetic terms and why the brackets with flux Hamiltonians should vanish. This relate to how one *defines* the Kähler form. It was shown above that in case of flux Hamiltonians the definition of Kähler form as brackets gives the basic formula  $\{Q(H_A), Q(H_B)\} = Q(\{H_A, H_B\})$  and same should hold true now. In the recent case  $J_{A,B}$  would contain an interaction term defined in terms of flux Hamiltonians and the previous argument should go through also now by identifying Hamiltonians as sums of two contributions and by introducing the doubling of the coordinates  $t_A$ .
5. The quantization of the modified Dirac operator must be reconsidered. It would seem that one must add to the super-Hamiltonian completely analogous term obtained by replacing  $(1 + K)J$  with  $X \partial(s^1, s^2) / \partial(x^1_{\pm}, x^2_{\pm})$ . Besides the anticommutation relations defining correct anticommutators to flux Hamiltonians, one should pose anticommutation relations consistent with the anticommutation relations of super Hamiltonians. In these anticommutation relations  $(1 + K)J \delta^2(x, y)$  would be replaced with  $X \delta^2(s^+, s^-)$ . This would guarantee that the oscillator operators at the ends of the line are not independent and that the resulting Hamiltonian reduces to integral over either end for  $H_{[A,B]}$ .
6. In the case of  $CP_2$  the Hamiltonians generating isometries are rational functions. This should hold true also now so that p-adic variants of Hamiltonians as functions in WCW would make sense. This in turn would imply that the components of the WCW Kähler form are rational functions. Also the exponentiation of Hamiltonians make sense p-adically if one allows the exponents of group parameters to be functions  $Exp_p(t)$ .

### Does the expansion in terms of partial harmonics converge?

The individual terms in the partial wave expansion seem to be finite but it is not at all clear whether the expansion in powers of  $K$  actually converges.

1. In the proposed scenario one performs the expansion of the vacuum functional  $\exp(K)$  in powers of  $K$  and therefore in negative powers of  $\alpha_K$ . In principle an infinite number of terms can be present. This is analogous to the perturbative expansion based on using magnetic monopoles as basic objects whereas the expansion using the contravariant Kähler metric as a propagator would be in positive powers of  $\alpha_K$  and analogous to the expansion in terms of magnetically bound states of wormhole throats with vanishing net value of magnetic charge. At this moment one can only suggest various approaches to how one could understand the situation.
2. Weak form of self-duality and magnetic confinement could change the situation. Performing the perturbation around magnetic flux tubes together with the assumed slicing of the space-time sheet by stringy world sheets and partonic 2-surfaces could mean that the perturbation corresponds to the action assignable to the electric part of Kähler form proportional to  $\alpha_K$  by the weak self-duality. Hence by  $K = 4\pi\alpha_K$  relating Kähler electric field to Kähler magnetic field the expansion would come in powers of a term containing sum of terms proportional to  $\alpha_K^0$  and  $\alpha_K$ . This would leave to the scattering amplitudes the exponents of Kähler function at the maximum of Kähler function so that the non-analytic dependence on  $\alpha_K$  would not disappear.

A further reason to be worried about is that the expansion containing infinite number of terms proportional to  $\alpha_K^0$  could fail to converge.

1. This could be also seen as a reason for why magnetic singlets are unavoidable except perhaps for  $\hbar < \hbar_0$ . By the holomorphic factorization the powers of the interaction part of Kähler action in powers of  $1/\alpha_K$  would naturally correspond to increasing and opposite net values of the quantum numbers assignable to the WCW phase coordinates at the ends of the propagator line. The magnetic bound states could have similar expansion in powers of  $\alpha_K$  as pairs of states with arbitrarily high but opposite values of quantum numbers. In the functional integral these quantum numbers would compensate each other. The functional integral would leave only an expansion containing powers of  $\alpha_K$  starting from some finite possibly negative (unless one assumes the weak form of self-duality) power. Various gauge coupling strengths are expected to be proportional to  $\alpha_K$  and these expansions should reduce to those in powers of  $\alpha_K$ .
2. Since the number of terms in the fermionic propagator expansion is finite, one might hope on basis of super-symmetry that the same is true in the case of the functional integral expansion. By the holomorphic factorization the expansion in powers of  $K$  means the appearance of terms with increasingly higher quantum numbers. Quantum number conservation at vertices would leave only a finite number of terms to tree diagrams. In the case of loop diagrams pairs of particles with opposite and arbitrarily high values of quantum numbers could be generated at the vertex and magnetic confinement might be necessary to guarantee the convergence. Also super-symmetry could imply cancellations in loops.

### Could one do without flux Hamiltonians?

The fact that the Kähler functions associated with the propagator lines can be regarded as interaction terms inspires the question whether the Kähler function could contain only the interaction terms so that Kähler form and Kähler metric would have components only between the ends of the lines.

1. The basic objection is that flux Hamiltonians too beautiful objects to be left without any role in the theory. One could also argue that the WCW metric would not be positive definite if only the non-diagonal interaction term is present. The simplest example is Hermitian  $2 \times 2$ -matrix with vanishing diagonal for which eigenvalues are real but of opposite sign.
2. One could of course argue that the expansions of  $\exp(K)$  and  $\lambda_k$  give in the general powers  $(f_n \overline{f_n})^m$  analogous to diverging tadpole diagrams of quantum field theories due to local interaction vertices. These terms do not produce divergences now but the possibility that the

exponential series of this kind of terms could diverge cannot be excluded. The absence of the kinetic terms would allow to get rid of these terms and might be argued to be the symmetric space counterpart for the vanishing of loops in WCW integral.

3. In zero energy ontology this idea does not look completely non-sensical since physical states are pairs of positive and negative energy states. Note also that in quantum theory only creation operators are used to create positive energy states. The manifest non-locality of the interaction terms and absence of the counterparts of kinetic terms would provide a trivial manner to get rid of infinities due to the presence of local interactions. The safest option is however to keep both terms.

### Summary

The discussion suggests that one must treat the entire Feynman graph as single geometric object with Kähler geometry in which the symmetric space is defined as product of what could be regarded as analogs of symmetric spaces with interaction terms of the metric coming from the propagator lines. The exponent of Kähler function would be the product of exponents associated with all lines and contributions to lines depend on quantum numbers (momentum and color quantum numbers) propagating in line via the coupling to the modified Dirac operator. The conformal factorization would allow the reduction of integrations to Fourier analysis in symmetric space. What is of decisive importance is that the entire Feynman diagrammatics at WCW level would reduce to the construction of WCW geometry for a single propagator line as a function of quantum numbers propagating on the line.



# Mathematics

- [A1] Gaussian Mersenne. <http://primes.utm.edu/glossary/xpage/GaussianMersenne.html>.
- [A2] Z. I. Borevich and I. R. Shafarevich. *Number Theory*. Academic Press, 1966.
- [A3] Eisenhart. *Riemannian Geometry*. Princeton University Press, 1964.
- [A4] C. N. Pope G. W. Gibbons.  $CP_2$  as gravitational instanton. *Comm. Math. Phys.*, 55, 1977.
- [A5] W. Hawking, S. and N. Pope, C. Generalized Spin Structures in Quantum Gravity. *Phys. Lett.*, (1), 1978.
- [A6] S. Helgason. *Differential Geometry and Symmetric Spaces*. Academic Press, New York, 1962.
- [A7] C. Itzykson and J-B. Zuber. *Quantum Field Theory*, volume 549. Mc Graw-Hill, New York, 1980.
- [A8] J. Milnor. *Topology form Differential Point of View*. The University Press of Virginia, Virginia, 1965.
- [A9] D. S. Moak. The q-analogue of the Laguerre polynomials. *J. Math. Anal. Appl.*, 81, 1981.
- [A10] N. Pope, C. Eigenfunctions and  $Spin^c$  Structures on  $CP_2$ , 1980.
- [A11] B. Shipman. The geometry of momentum mappings on generalized flag manifolds, connections with a dynamical system, quantum mechanics and the dance of honeybee. <http://math.cornell.edu/~oliver/Shipman.gif>, 1998.
- [A12] M. Spivak. *Differential Geometry I,II,III,IV*. Publish or Perish, Boston, 1970.
- [A13] J. Hanson T. Eguchi, B. Gilkey. *Phys. Rep.*, 66:1980, 1980.
- [A14] R. Thom. *Commentarii Math. Helvet.*, 28, 1954.
- [A15] Wallace. *Differential Topology*. W. A. Benjamin, New York, 1968.
- [A16] E. C. Zeeman. *Catastrophe Theory*. Addison-Wessley Publishing Company, 1977.



# Theoretical Physics

- [B1] J. Björken and S. Drell. *Relativistic Quantum Fields*. Mc Graw-Hill, New York, 1965.
- [B2] K. Huang. *Quarks, Leptons & Gauge Fields*. World Scientific, 1982.
- [B3] R. Kiehn. Electromagnetic waves in vacuum with torsion and spin. <http://www22.pair.com/csdc/pdf/helical6.pdf>.
- [B4] G. Parisi. *Field Theory, Disorder and Simulations*. World Scientific, 1992.
- [B5] A. Zee. *The Unity of Forces in the Universe*. World Science Press, Singapore, 1982.



# Particle and Nuclear Physics

- [C1] Giant Dipole Resonance: What is Known About? <http://cdfc.sinp.msu.ru/publications/lshkhv-ELI03.pdf>.
- [C2] Abragam A. *The principles of nuclear magnetism*. Clarendon Press, Oxford, 1961.
- [C3] C. Rolfs et al. First hints on a change of the  $^{22}\text{Na}$  beta decay half-life in the metal Pd. *Eur. Phys. J. A*, 28, 2006.
- [C4] C. Rolfs et al. High-Z electron screening, the cases  $^{50}\text{V}(p,n)^{50}$ . *Eur. Phys. J. A*, 28, 2006.
- [C5] G. Tertuchny et al. Microscopic description of the pygmy and giant electric dipole resonances in stable Ca isotopes. <http://arxiv.org/abs/nucl-th/0603/0603051>, 2006.
- [C6] S. E. Shnoll et al. Realization of discrete states during fluctuations in macroscopic processes. *Uspekhi Fisicheskikh Nauk*, 41(10):1025–1035, 1998.
- [C7] V. M. Lobashev et al. In *Neutrino 96*, Singapore, 1996. World Scientific.
- [C8] K. Langanke H. J. Assenbaum and C. Rolfs. *Z. Phys. A*, 327, 1987.
- [C9] A. D. Krisch. The spin of proton. *Scientific American*, May 1979.
- [C10] M. T. Ressel and M. S. Turner. *Astrophys.*, 14, 1990.
- [C11] C. Rolfs and W. S. Rodney. *Cauldrons in the Cosmos*. University of Chicago Press, Chicago, 1988.



# Books related to TGD

- [K1] M. Pitkänen. 1983.
- [K2] M. Pitkänen. Is it Possible to Understand Coupling Constant Evolution at Space-Time Level? In *Towards M-Matrix*. Onlinebook. [http://tgdtheory.com/public\\_html/tgdquant/tgdquant.html#rgflow](http://tgdtheory.com/public_html/tgdquant/tgdquant.html#rgflow), 2006.
- [K3] M. Pitkänen. About Strange Effects Related to Rotating Magnetic Systems . In *TGD and Fringe Physics*. Onlinebook. [http://tgdtheory.com/public\\_html/freenergy/freenergy.html#Faraday](http://tgdtheory.com/public_html/freenergy/freenergy.html#Faraday), 2006.
- [K4] M. Pitkänen. About the New Physics Behind Qualia. In *Quantum Hardware of Living Matter*. Onlinebook. [http://tgdtheory.com/public\\_html/bioware/bioware.html#newphys](http://tgdtheory.com/public_html/bioware/bioware.html#newphys), 2006.
- [K5] M. Pitkänen. An Overview about Quantum TGD: Part I. In *Topological Geometrodynamics: Overview*. Onlinebook. [http://tgdtheory.com/public\\_html/tgdview/tgdview.html#evoII](http://tgdtheory.com/public_html/tgdview/tgdview.html#evoII), 2006.
- [K6] M. Pitkänen. An Overview about the Evolution of Quantum TGD. In *Topological Geometrodynamics: Overview*. Onlinebook. [http://tgdtheory.com/public\\_html/tgdview/tgdview.html#evoI](http://tgdtheory.com/public_html/tgdview/tgdview.html#evoI), 2006.
- [K7] M. Pitkänen. Anomalies Related to the Classical  $Z^0$  Force and Gravitation. In *TGD and Fringe Physics*. Onlinebook. [http://tgdtheory.com/public\\_html/freenergy/freenergy.html#Zanom](http://tgdtheory.com/public_html/freenergy/freenergy.html#Zanom), 2006.
- [K8] M. Pitkänen. Appendix A: Quantum Groups and Related Structures. In *Towards M-Matrix*. Onlinebook. [http://tgdtheory.com/public\\_html/tgdquant/tgdquant.html#bialgebra](http://tgdtheory.com/public_html/tgdquant/tgdquant.html#bialgebra), 2006.
- [K9] M. Pitkänen. Basic Extremals of Kähler Action. In *Physics in Many-Sheeted Space-Time*. Onlinebook. [http://tgdtheory.com/public\\_html/tgdclass/tgdclass.html#class](http://tgdtheory.com/public_html/tgdclass/tgdclass.html#class), 2006.
- [K10] M. Pitkänen. *Bio-Systems as Conscious Holograms*. Onlinebook. [http://tgdtheory.com/public\\_html/hologram/hologram.html](http://tgdtheory.com/public_html/hologram/hologram.html), 2006.
- [K11] M. Pitkänen. Bio-Systems as Conscious Holograms. In *Bio-Systems as Conscious Holograms*. Onlinebook. [http://tgdtheory.com/public\\_html/hologram/hologram.html#hologram](http://tgdtheory.com/public_html/hologram/hologram.html#hologram), 2006.
- [K12] M. Pitkänen. *Bio-Systems as Self-Organizing Quantum Systems*. Onlinebook. [http://tgdtheory.com/public\\_html/bioselforg/bioselforg.html](http://tgdtheory.com/public_html/bioselforg/bioselforg.html), 2006.
- [K13] M. Pitkänen. Bio-Systems as Super-Conductors: part I. In *Quantum Hardware of Living Matter*. Onlinebook. [http://tgdtheory.com/public\\_html/bioware/bioware.html#superc1](http://tgdtheory.com/public_html/bioware/bioware.html#superc1), 2006.
- [K14] M. Pitkänen. Bio-Systems as Super-Conductors: part II. In *Quantum Hardware of Living Matter*. Onlinebook. [http://tgdtheory.com/public\\_html/bioware/bioware.html#superc2](http://tgdtheory.com/public_html/bioware/bioware.html#superc2), 2006.
- [K15] M. Pitkänen. Configuration Space Spinor Structure. In *Quantum Physics as Infinite-Dimensional Geometry*. Onlinebook. [http://tgdtheory.com/public\\_html/tgdgeom/tgdgeom.html#cspin](http://tgdtheory.com/public_html/tgdgeom/tgdgeom.html#cspin), 2006.

- [K16] M. Pitkänen. Construction of elementary particle vacuum functionals. In *p-Adic Length Scale Hypothesis and Dark Matter Hierarchy*. Onlinebook. [http://tgdtheory.com/public\\_html/paddark/paddark.html#elvafu](http://tgdtheory.com/public_html/paddark/paddark.html#elvafu), 2006.
- [K17] M. Pitkänen. Construction of Quantum Theory: M-matrix. In *Towards M-Matrix*. Onlinebook. [http://tgdtheory.com/public\\_html/tgdquant/tgdquant.html#towards](http://tgdtheory.com/public_html/tgdquant/tgdquant.html#towards), 2006.
- [K18] M. Pitkänen. Cosmic Strings. In *Physics in Many-Sheeted Space-Time*. Onlinebook. [http://tgdtheory.com/public\\_html/tgdclass/tgdclass.html#cstrings](http://tgdtheory.com/public_html/tgdclass/tgdclass.html#cstrings), 2006.
- [K19] M. Pitkänen. Crop Circles and Life at Parallel Space-Time Sheets. In *Magnetospheric Consciousness*. Onlinebook. [http://tgdtheory.com/public\\_html/magnconsc/magnconsc.html#crop1](http://tgdtheory.com/public_html/magnconsc/magnconsc.html#crop1), 2006.
- [K20] M. Pitkänen. Crop Circles and Life at Parallel Space-Time Sheets. In *Magnetospheric Consciousness*. Onlinebook. [http://tgdtheory.com/public\\_html/magnconsc/magnconsc.html#crop2](http://tgdtheory.com/public_html/magnconsc/magnconsc.html#crop2), 2006.
- [K21] M. Pitkänen. Dark Forces and Living Matter. In *p-Adic Length Scale Hypothesis and Dark Matter Hierarchy*. Onlinebook. [http://tgdtheory.com/public\\_html/paddark/paddark.html#darkforces](http://tgdtheory.com/public_html/paddark/paddark.html#darkforces), 2006.
- [K22] M. Pitkänen. Dark Matter Hierarchy and Hierarchy of EEGs. In *TGD and EEG*. Onlinebook. [http://tgdtheory.com/public\\_html/tgdeeg/tgdeeg.html#eegdark](http://tgdtheory.com/public_html/tgdeeg/tgdeeg.html#eegdark), 2006.
- [K23] M. Pitkänen. Dark Nuclear Physics and Condensed Matter. In *p-Adic Length Scale Hypothesis and Dark Matter Hierarchy*. Onlinebook. [http://tgdtheory.com/public\\_html/paddark/paddark.html#exonuclear](http://tgdtheory.com/public_html/paddark/paddark.html#exonuclear), 2006.
- [K24] M. Pitkänen. DNA as Topological Quantum Computer. In *Genes and Memes*. Onlinebook. [http://tgdtheory.com/public\\_html/genememe/genememe.html#dnatqc](http://tgdtheory.com/public_html/genememe/genememe.html#dnatqc), 2006.
- [K25] M. Pitkänen. Does TGD Predict the Spectrum of Planck Constants? In *Towards M-Matrix*. Onlinebook. [http://tgdtheory.com/public\\_html/tgdquant/tgdquant.html#Planck](http://tgdtheory.com/public_html/tgdquant/tgdquant.html#Planck), 2006.
- [K26] M. Pitkänen. Evolution in Many-Sheeted Space-Time. In *Genes and Memes*. Onlinebook. [http://tgdtheory.com/public\\_html/genememe/genememe.html#prebio](http://tgdtheory.com/public_html/genememe/genememe.html#prebio), 2006.
- [K27] M. Pitkänen. General Ideas about Many-Sheeted Space-Time: Part I. In *Physics in Many-Sheeted Space-Time*. Onlinebook. [http://tgdtheory.com/public\\_html/tgdclass/tgdclass.html#topcond](http://tgdtheory.com/public_html/tgdclass/tgdclass.html#topcond), 2006.
- [K28] M. Pitkänen. General Theory of Qualia. In *Bio-Systems as Conscious Holograms*. Onlinebook. [http://tgdtheory.com/public\\_html/hologram/hologram.html#qualia](http://tgdtheory.com/public_html/hologram/hologram.html#qualia), 2006.
- [K29] M. Pitkänen. *Genes and Memes*. Onlinebook. [http://tgdtheory.com/public\\_html/genememe/genememe.html](http://tgdtheory.com/public_html/genememe/genememe.html), 2006.
- [K30] M. Pitkänen. Genes and Memes. In *Genes and Memes*. Onlinebook. [http://tgdtheory.com/public\\_html/genememe/genememe.html#genemec](http://tgdtheory.com/public_html/genememe/genememe.html#genemec), 2006.
- [K31] M. Pitkänen. Homeopathy in Many-Sheeted Space-Time. In *Bio-Systems as Conscious Holograms*. Onlinebook. [http://tgdtheory.com/public\\_html/hologram/hologram.html#homeoc](http://tgdtheory.com/public_html/hologram/hologram.html#homeoc), 2006.
- [K32] M. Pitkänen. Macro-Temporal Quantum Coherence and Spin Glass Degeneracy. In *Bio-Systems as Conscious Holograms*. Onlinebook. [http://tgdtheory.com/public\\_html/hologram/hologram.html#macro](http://tgdtheory.com/public_html/hologram/hologram.html#macro), 2006.
- [K33] M. Pitkänen. Macroscopic Quantum Coherence and Quantum Metabolism as Different Sides of the Same Coin. In *Bio-Systems as Conscious Holograms*. Onlinebook. [http://tgdtheory.com/public\\_html/hologram/hologram.html#metab](http://tgdtheory.com/public_html/hologram/hologram.html#metab), 2006.



- [K34] M. Pitkänen. Macroscopic Quantum Phenomena and  $CP_2$  Geometry. In *Physics in Many-Sheeted Space-Time*. Onlinebook. [http://tgdtheory.com/public\\_html/tgdclass/tgdclass.html#super](http://tgdtheory.com/public_html/tgdclass/tgdclass.html#super), 2006.
- [K35] M. Pitkänen. Magnetic Sensory Canvas Hypothesis. In *TGD and EEG*. Onlinebook. [http://tgdtheory.com/public\\_html//tgdeeg/tgdeeg/tgdeeg.html#mec](http://tgdtheory.com/public_html//tgdeeg/tgdeeg/tgdeeg.html#mec), 2006.
- [K36] M. Pitkänen. *Magnetospheric Consciousness*. Onlinebook. [http://tgdtheory.com/public\\_html/magnconsc/magnconsc.html](http://tgdtheory.com/public_html/magnconsc/magnconsc.html), 2006.
- [K37] M. Pitkänen. Magnetospheric Sensory Representations. In *Magnetospheric Consciousness*. Onlinebook. [http://tgdtheory.com/public\\_html/magnconsc/magnconsc.html#srepres](http://tgdtheory.com/public_html/magnconsc/magnconsc.html#srepres), 2006.
- [K38] M. Pitkänen. Many-Sheeted DNA. In *Genes and Memes*. Onlinebook. [http://tgdtheory.com/public\\_html/genememe/genememe.html#genecodec](http://tgdtheory.com/public_html/genememe/genememe.html#genecodec), 2006.
- [K39] M. Pitkänen. Massless states and particle massivation. In *p-Adic Length Scale Hypothesis and Dark Matter Hierarchy*. Onlinebook. [http://tgdtheory.com/public\\_html/paddark/paddark.html#mless](http://tgdtheory.com/public_html/paddark/paddark.html#mless), 2006.
- [K40] M. Pitkänen. *Mathematical Aspects of Consciousness Theory*. Onlinebook. [http://tgdtheory.com/public\\_html/mathconsc/mathconsc.html](http://tgdtheory.com/public_html/mathconsc/mathconsc.html), 2006.
- [K41] M. Pitkänen. Matter, Mind, Quantum. In *TGD Inspired Theory of Consciousness*. Onlinebook. [http://tgdtheory.com/public\\_html/tgdconsc/tgdconsc.html#conscic](http://tgdtheory.com/public_html/tgdconsc/tgdconsc.html#conscic), 2006.
- [K42] M. Pitkänen. Negentropy Maximization Principle. In *TGD Inspired Theory of Consciousness*. Onlinebook. [http://tgdtheory.com/public\\_html/tgdconsc/tgdconsc.html#nmpc](http://tgdtheory.com/public_html/tgdconsc/tgdconsc.html#nmpc), 2006.
- [K43] M. Pitkänen. New Particle Physics Predicted by TGD: Part I. In *p-Adic Length Scale Hypothesis and Dark Matter Hierarchy*. Onlinebook. [http://tgdtheory.com/public\\_html/paddark/paddark.html#mass4](http://tgdtheory.com/public_html/paddark/paddark.html#mass4), 2006.
- [K44] M. Pitkänen. Nuclear String Hypothesis. In *p-Adic Length Scale Hypothesis and Dark Matter Hierarchy*. Onlinebook. [http://tgdtheory.com/public\\_html/paddark/paddark.html#nuclstring](http://tgdtheory.com/public_html/paddark/paddark.html#nuclstring), 2006.
- [K45] M. Pitkänen. *p-Adic length Scale Hypothesis and Dark Matter Hierarchy*. Onlinebook. [http://tgdtheory.com/public\\_html/paddark/paddark.html](http://tgdtheory.com/public_html/paddark/paddark.html), 2006.
- [K46] M. Pitkänen. p-Adic Particle Massivation: Hadron Masses. In *p-Adic Length Scale Hypothesis and Dark Matter Hierarchy*. Onlinebook. [http://tgdtheory.com/public\\_html/paddark/paddark.html#mass3](http://tgdtheory.com/public_html/paddark/paddark.html#mass3), 2006.
- [K47] M. Pitkänen. p-Adic Physics as Physics of Cognition and Intention. In *TGD Inspired Theory of Consciousness*. Onlinebook. [http://tgdtheory.com/public\\_html/tgdconsc/tgdconsc.html#cognic](http://tgdtheory.com/public_html/tgdconsc/tgdconsc.html#cognic), 2006.
- [K48] M. Pitkänen. *Physics in Many-Sheeted Space-Time*. Onlinebook. [http://tgdtheory.com/public\\_html/tgdclass/tgdclass.html](http://tgdtheory.com/public_html/tgdclass/tgdclass.html), 2006.
- [K49] M. Pitkänen. Quantum Antenna Hypothesis. In *Quantum Hardware of Living Matter*. Onlinebook. [http://tgdtheory.com/public\\_html/bioware/bioware.html#tubuc](http://tgdtheory.com/public_html/bioware/bioware.html#tubuc), 2006.
- [K50] M. Pitkänen. Quantum Astrophysics. In *Physics in Many-Sheeted Space-Time*. Onlinebook. [http://tgdtheory.com/public\\_html/tgdclass/tgdclass.html#qastro](http://tgdtheory.com/public_html/tgdclass/tgdclass.html#qastro), 2006.
- [K51] M. Pitkänen. Quantum Control and Coordination in Bio-systems: Part I. In *Bio-Systems as Self-Organizing Quantum Systems*. Onlinebook. [http://tgdtheory.com/public\\_html/bioselforg/bioselforg.html#qcococI](http://tgdtheory.com/public_html/bioselforg/bioselforg.html#qcococI), 2006.
- [K52] M. Pitkänen. Quantum Control and Coordination in Bio-Systems: Part II. In *Bio-Systems as Self-Organizing Quantum Systems*. Onlinebook. [http://tgdtheory.com/public\\_html/bioselforg/bioselforg.html#qcococII](http://tgdtheory.com/public_html/bioselforg/bioselforg.html#qcococII), 2006.

- [K53] M. Pitkänen. *Quantum Hardware of Living Matter*. Onlinebook. [http://tgdtheory.com/public\\_html/bioware/bioware.html](http://tgdtheory.com/public_html/bioware/bioware.html), 2006.
- [K54] M. Pitkänen. Quantum Model for Hearing. In *TGD and EEG*. Onlinebook. [http://tgdtheory.com/public\\_html//tgdeeg/tgdeeg/tgdeeg.html#hearing](http://tgdtheory.com/public_html//tgdeeg/tgdeeg/tgdeeg.html#hearing), 2006.
- [K55] M. Pitkänen. Quantum Model for Nerve Pulse. In *TGD and EEG*. Onlinebook. [http://tgdtheory.com/public\\_html//tgdeeg/tgdeeg/tgdeeg.html#pulse](http://tgdtheory.com/public_html//tgdeeg/tgdeeg/tgdeeg.html#pulse), 2006.
- [K56] M. Pitkänen. Quantum Model for Paranormal Phenomena. In *TGD Inspired Theory of Consciousness*. Onlinebook. [http://tgdtheory.com/public\\_html/tgdconsc/tgdconsc.html#parac](http://tgdtheory.com/public_html/tgdconsc/tgdconsc.html#parac), 2006.
- [K57] M. Pitkänen. Quantum Model for Sensory Representations. In *TGD Inspired Theory of Consciousness*. Onlinebook. [http://tgdtheory.com/public\\_html/tgdconsc/tgdconsc.html#expc](http://tgdtheory.com/public_html/tgdconsc/tgdconsc.html#expc), 2006.
- [K58] M. Pitkänen. Quantum Model of EEG. In *TGD and EEG*. Onlinebook. [http://tgdtheory.com/public\\_html/tgdeeg/tgdeeg.html#eegII](http://tgdtheory.com/public_html/tgdeeg/tgdeeg.html#eegII), 2006.
- [K59] M. Pitkänen. Quantum Model of Memory. In *TGD Inspired Theory of Consciousness*. Onlinebook. [http://tgdtheory.com/public\\_html/tgdconsc/tgdconsc.html#memoryc](http://tgdtheory.com/public_html/tgdconsc/tgdconsc.html#memoryc), 2006.
- [K60] M. Pitkänen. *Quantum Physics as Infinite-Dimensional Geometry*. Onlinebook. [http://tgdtheory.com/public\\_html/tgdgeom/tgdgeom.html](http://tgdtheory.com/public_html/tgdgeom/tgdgeom.html), 2006.
- [K61] M. Pitkänen. *Quantum TGD*. Onlinebook. [http://tgdtheory.com/public\\_html/tgdquant/tgdquant.html](http://tgdtheory.com/public_html/tgdquant/tgdquant.html), 2006.
- [K62] M. Pitkänen. Quantum Theory of Self-Organization. In *Bio-Systems as Self-Organizing Quantum Systems*. Onlinebook. [http://tgdtheory.com/public\\_html/bioselforg/bioselforg.html#selforgac](http://tgdtheory.com/public_html/bioselforg/bioselforg.html#selforgac), 2006.
- [K63] M. Pitkänen. Semi-trance, Mental Illness, and Altered States of Consciousness. In *Magnetospheric Consciousness*. Onlinebook. [http://tgdtheory.com/public\\_html/magnconsc/magnconsc.html#semitrancec](http://tgdtheory.com/public_html/magnconsc/magnconsc.html#semitrancec), 2006.
- [K64] M. Pitkänen. Semitrance, Language, and Development of Civilization. In *Magnetospheric Consciousness*. Onlinebook. [http://tgdtheory.com/public\\_html/magnconsc/magnconsc.html#langsoc](http://tgdtheory.com/public_html/magnconsc/magnconsc.html#langsoc), 2006.
- [K65] M. Pitkänen. TGD and Astrophysics. In *Physics in Many-Sheeted Space-Time*. Onlinebook. [http://tgdtheory.com/public\\_html/tgdclass/tgdclass.html#astro](http://tgdtheory.com/public_html/tgdclass/tgdclass.html#astro), 2006.
- [K66] M. Pitkänen. TGD and Cosmology. In *Physics in Many-Sheeted Space-Time*. Onlinebook. [http://tgdtheory.com/public\\_html/tgdclass/tgdclass.html#cosmo](http://tgdtheory.com/public_html/tgdclass/tgdclass.html#cosmo), 2006.
- [K67] M. Pitkänen. *TGD and EEG*. Onlinebook. [http://tgdtheory.com/public\\_html/tgdeeg/tgdeeg.html](http://tgdtheory.com/public_html/tgdeeg/tgdeeg.html), 2006.
- [K68] M. Pitkänen. *TGD and Fringe Physics*. Onlinebook. [http://tgdtheory.com/public\\_html/freenergy/freenergy.html](http://tgdtheory.com/public_html/freenergy/freenergy.html), 2006.
- [K69] M. Pitkänen. TGD and Nuclear Physics. In *p-Adic Length Scale Hypothesis and Dark Matter Hierarchy*. Onlinebook. [http://tgdtheory.com/public\\_html/paddark/paddark.html#padnucl](http://tgdtheory.com/public_html/paddark/paddark.html#padnucl), 2006.
- [K70] M. Pitkänen. *TGD as a Generalized Number Theory*. Onlinebook. [http://tgdtheory.com/public\\_html/tgdnumber/tgdnumber.html](http://tgdtheory.com/public_html/tgdnumber/tgdnumber.html), 2006.
- [K71] M. Pitkänen. TGD as a Generalized Number Theory: p-Adicization Program. In *TGD as a Generalized Number Theory*. Onlinebook. [http://tgdtheory.com/public\\_html/tgdnumber/tgdnumber.html#visiona](http://tgdtheory.com/public_html/tgdnumber/tgdnumber.html#visiona), 2006.

- [K72] M. Pitkänen. TGD as a Generalized Number Theory: Quaternions, Octonions, and their Hyper Counterparts. In *TGD as a Generalized Number Theory*. Onlinebook. [http://tgdtheory.com/public\\_html/tgdnumber/tgdnumber.html#visionb](http://tgdtheory.com/public_html/tgdnumber/tgdnumber.html#visionb), 2006.
- [K73] M. Pitkänen. TGD Based Model for OBEs. In *TGD Inspired Theory of Consciousness*. Onlinebook. [http://tgdtheory.com/public\\_html/tgdconsc/tgdconsc.html#OBE](http://tgdtheory.com/public_html/tgdconsc/tgdconsc.html#OBE), 2006.
- [K74] M. Pitkänen. *TGD Inspired Theory of Consciousness*. Onlinebook. [http://tgdtheory.com/public\\_html/tgdconsc/tgdconsc.html](http://tgdtheory.com/public_html/tgdconsc/tgdconsc.html), 2006.
- [K75] M. Pitkänen. TGD Inspired Theory of Consciousness. In *Topological Geometrodynamics: Overview*. Onlinebook. [http://tgdtheory.com/public\\_html/tgdview/tgdview.html#tgdconsc2010](http://tgdtheory.com/public_html/tgdview/tgdview.html#tgdconsc2010), 2006.
- [K76] M. Pitkänen. The Notion of Free Energy and Many-Sheeted Space-Time Concept. In *TGD and Fringe Physics*. Onlinebook. [http://tgdtheory.com/public\\_html/freenergy/freenergy.html#freenergy](http://tgdtheory.com/public_html/freenergy/freenergy.html#freenergy), 2006.
- [K77] M. Pitkänen. The Relationship Between TGD and GRT. In *Physics in Many-Sheeted Space-Time*. Onlinebook. [http://tgdtheory.com/public\\_html/tgdclass/tgdclass.html#tgdgrt](http://tgdtheory.com/public_html/tgdclass/tgdclass.html#tgdgrt), 2006.
- [K78] M. Pitkänen. Three new physics realizations of the genetic code and the role of dark matter in bio-systems. In *Genes and Memes*. Onlinebook. [http://tgdtheory.com/public\\_html/genememe/genememe.html#dnatqccodes](http://tgdtheory.com/public_html/genememe/genememe.html#dnatqccodes), 2006.
- [K79] M. Pitkänen. Time, Spacetime and Consciousness. In *Bio-Systems as Conscious Holograms*. Onlinebook. [http://tgdtheory.com/public\\_html/hologram/hologram.html#time](http://tgdtheory.com/public_html/hologram/hologram.html#time), 2006.
- [K80] M. Pitkänen. *Topological Geometrodynamics: an Overview*. Onlinebook. [http://tgdtheory.com/public\\_html/tgdview/tgdview.html](http://tgdtheory.com/public_html/tgdview/tgdview.html), 2006.
- [K81] M. Pitkänen. Topological Quantum Computation in TGD Universe. In *Genes and Memes*. Onlinebook. [http://tgdtheory.com/public\\_html/genememe/genememe.html#tqc](http://tgdtheory.com/public_html/genememe/genememe.html#tqc), 2006.
- [K82] M. Pitkänen. Was von Neumann Right After All. In *Towards M-Matrix*. Onlinebook. [http://tgdtheory.com/public\\_html/tgdquant/tgdquant.html#vNeumann](http://tgdtheory.com/public_html/tgdquant/tgdquant.html#vNeumann), 2006.
- [K83] M. Pitkänen. Wormhole Magnetic Fields. In *Quantum Hardware of Living Matter*. Onlinebook. [http://tgdtheory.com/public\\_html/bioware/bioware.html#wormc](http://tgdtheory.com/public_html/bioware/bioware.html#wormc), 2006.



# Articles about TGD

- [L1] M. Pitkänen. Macro-temporal quantum coherence, quantum spin glass degeneracy, and number theoretic information concept. <http://www.emergentmind.org/journal.htm>, 2003.
- [L2] M. Pitkänen. Time, Space-Time, and Consciousness. <http://www.emergentmind.org/journal.htm>, 2003.
- [L3] M. Pitkänen. Further Progress in Nuclear String Hypothesis. <http://tgdtheory.com/articles/nuclstring.pdf>, 2007.
- [L4] M. Pitkänen. TGD based solution of Fermi paradox. <http://www.physics.helsinki.fi/~matpitka/articles/fermieng.pdf>, 2007.



## Chapter 6

# Construction of Quantum Theory: More about Matrices

### 6.1 Introduction

This chapter is a second part of chapter representing material related to the construction of  $U$ -,  $M$ -, and  $S$ -matrices. The general philosophy is discussed in the first part of the chapter and I will not repeat the discussion. The

The views about  $M$ -matrix as a characterizer of time-like entanglement and  $M$ -matrix as a functor are analyzed. The role of hyper-finite factors in the construction of  $M$ -matrix is considered. One section is devoted to the possibility that Connes tensor product could define fundamental vertices. The last section is devoted to the construction of unitary  $U$ -matrix characterizing the unitary process forming part of quantum jump.

The last section is about the anatomy of quantum jump. The first part of the chapter began with a similar piece of text. This reflects the fact that the ideas are developing all the time so that the vision about the matrices is by no means top-down view beginning from precisely state assumption and proceeding to conclusions.

The reader wishing for a brief summary of TGD might find the three articles about TGD, TGD inspired theory of consciousness, and TGD based view about quantum biology helpful [?, ?, ?] .

### 6.2 The latest vision about the role of HFFs in TGD

It is clear that at least the hyper-finite factors of type  $II_1$  assignable to WCW spinors must have a profound role in TGD. Whether also HFFs of type  $III_1$  appearing also in relativistic quantum field theories emerge when WCW spinors are replaced with spinor fields is not completely clear. I have proposed several ideas about the role of hyper-finite factors in TGD framework. In particular, Connes tensor product is an excellent candidate for defining the notion of measurement resolution.

In the following this topic is discussed from the perspective made possible by zero energy ontology and the recent advances in the understanding of  $M$ -matrix using the notion of bosonic emergence. The conclusion is that the notion of state as it appears in the theory of factors is not enough for the purposes of quantum TGD. The reason is that state in this sense is essentially the counterpart of thermodynamical state. The construction of  $M$ -matrix might be understood in the framework of factors if one replaces state with its "complex square root" natural if quantum theory is regarded as a "complex square root" of thermodynamics. It is also found that the idea that Connes tensor product could fix  $M$ -matrix is too optimistic but an elegant formulation in terms of partial trace for the notion of  $M$ -matrix modulo measurement resolution exists and Connes tensor product allows interpretation as entanglement between sub-spaces consisting of states not distinguishable in the measurement resolution used. The partial trace also gives rise to non-pure states naturally.

### 6.2.1 Basic facts about factors

In this section basic facts about factors are discussed. My hope that the discussion is more mature than or at least complementary to the summary that I could afford when I started the work with factors for more than half decade ago. I of course admit that this just a humble attempt of a physicist to express physical vision in terms of only superficially understood mathematical notions.

#### Basic notions

First some standard notations. Let  $\mathcal{B}(\mathcal{H})$  denote the algebra of linear operators of Hilbert space  $\mathcal{H}$  bounded in the norm topology with norm defined by the supremum of for the length of the image of a point of unit sphere  $\mathcal{H}$ . This algebra has a lot of common with complex numbers in that the counterparts of complex conjugation, order structure and metric structure determined by the algebraic structure exist. This means the existence involution -that is \*- algebra property. The order structure determined by algebraic structure means following:  $A \geq 0$  defined as the condition  $(A\xi, \xi) \geq 0$  is equivalent with  $A = B^*B$ . The algebra has also metric structure  $\|AB\| \leq \|A\|\|B\|$  (Banach algebra property) determined by the algebraic structure. The algebra is also  $C^*$  algebra:  $\|A^*A\| = \|A\|^2$  meaning that the norm is algebraically like that for complex numbers.

A von Neumann algebra  $\mathcal{M}$  [?] is defined as a weakly closed non-degenerate \*-subalgebra of  $\mathcal{B}(\mathcal{H})$  and has therefore all the above mentioned properties. From the point of view of physicist it is important that a sub-algebra is in question.

In order to define factors one must introduce additional structure.

1. Let  $\mathcal{M}$  be subalgebra of  $\mathcal{B}(\mathcal{H})$  and denote by  $\mathcal{M}'$  its commutant defined as the sub-algebra of  $\mathcal{B}(\mathcal{H})$  commuting with it and allowing to express  $\mathcal{B}(\mathcal{H})$  as  $\mathcal{B}(\mathcal{H}) = \mathcal{M} \vee \mathcal{M}'$ .
2. A factor is defined as a von Neumann algebra satisfying  $\mathcal{M}'' = \mathcal{M}$  is called factor. The equality of double commutant with the original algebra is thus the defining condition so that also the commutant is a factor. An equivalent definition for factor is as the condition that the intersection of the algebra and its commutant reduces to a complex line spanned by a unit operator. The condition that the only operator commuting with all operators of the factor is unit operator corresponds to irreducibility in representation theory.
3. Some further basic definitions are needed.  $\Omega \in \mathcal{H}$  is cyclic if the closure of  $\mathcal{M}\Omega$  is  $\mathcal{H}$  and separating if the only element of  $\mathcal{M}$  annihilating  $\Omega$  is zero.  $\Omega$  is cyclic for  $\mathcal{M}$  if and only if it is separating for its commutant. In so called standard representation  $\Omega$  is both cyclic and separating.
4. For hyperfinite factors an inclusion hierarchy of finite-dimensional algebras whose union is dense in the factor exists. This roughly means that one can approximate the algebra in arbitrary accuracy with a finite-dimensional sub-algebra.

The definition of the factor might look somewhat artificial unless one is aware of the underlying physical motivations. The motivating question is what the decomposition of a physical system to non-interacting sub-systems could mean. The decomposition of  $\mathcal{B}(\mathcal{H})$  to  $\vee$  product realizes this decomposition.

1. Tensor product  $\mathcal{H} = \mathcal{H}_1 \otimes \mathcal{H}_2$  is the decomposition according to the standard quantum measurement theory and means the decomposition of operators in  $\mathcal{B}(\mathcal{H})$  to tensor products of mutually commuting operators in  $\mathcal{M} = \mathcal{B}(\mathcal{H}_1)$  and  $\mathcal{M}' = \mathcal{B}(\mathcal{H}_2)$ . The information about  $\mathcal{M}$  can be coded in terms of projection operators. In this case projection operators projecting to a complex ray of Hilbert space exist and arbitrary compact operator can be expressed as a sum of these projectors. For factors of type I minimal projectors exist. Factors of type  $I_n$  correspond to sub-algebras of  $\mathcal{B}(\mathcal{H})$  associated with infinite-dimensional Hilbert space and  $I_\infty$  to  $\mathcal{B}(\mathcal{H})$  itself. These factors appear in the standard quantum measurement theory where state function reduction can lead to a ray of Hilbert space.
2. For factors of type II no minimal projectors exists whereas finite projectors exist. For factors of type  $II_1$  all projectors have trace not larger than one and the trace varies in the range  $(0, 1]$ . In this case cyclic vectors  $\Omega$  exist. State function reduction can lead only to an infinite-dimensional



subspace characterized by a projector with trace smaller than 1 but larger than zero. The natural interpretation would be in terms of finite measurement resolution. The tensor product of  $\text{II}_1$  factor and  $\text{I}_\infty$  is  $\text{II}_\infty$  factor for which the trace for a projector can have arbitrarily large values.  $\text{II}_1$  factor has a unique finite tracial state and the set of traces of projections spans unit interval. There is uncountable number of factors of type II but hyper-finite factors of type  $\text{II}_1$  are the exceptional ones and physically most interesting.

3. Factors of type III correspond to an extreme situation. In this case the projection operators  $E$  spanning the factor have either infinite or vanishing trace and there exists an isometry mapping  $E\mathcal{H}$  to  $\mathcal{H}$  meaning that the projection operator spans almost all of  $\mathcal{H}$ . All projectors are also related to each other by isometry. Factors of type III are smallest if the factors are regarded as sub-algebras of a fixed  $\mathcal{B}(\mathcal{H})$  where  $\mathcal{H}$  corresponds to isomorphism class of Hilbert spaces. Situation changes when one speaks about concrete representations. Also now hyper-finite factors are exceptional.
4. Von Neumann algebras define a non-commutative measure theory. Commutative von Neumann algebras indeed reduce to  $L^\infty(X)$  for some measure space  $(X, \mu)$  and vice versa.

### Weights, states and traces

The notions of weight, state, and trace are standard notions in the theory of von Neumann algebras.

1. A weight of von Neumann algebra is a linear map from the set of positive elements (those of form  $a^*a$ ) to non-negative reals.
2. A positive linear functional is weight with  $\omega(1)$  finite.
3. A state is a weight with  $\omega(1) = 1$ .
4. A trace is a weight with  $\omega(aa^*) = \omega(a^*a)$  for all  $a$ .
5. A tracial state is a weight with  $\omega(1) = 1$ .

A factor has a trace such that the trace of a non-zero projector is non-zero and the trace of projection is infinite only if the projection is infinite. The trace is unique up to a rescaling. For factors that are separable or finite, two projections are equivalent if and only if they have the same trace. Factors of type  $\text{I}_n$  the values of trace are equal to multiples of  $1/n$ . For a factor of type  $\text{I}_\infty$  the value of trace are  $0, 1, 2, \dots$ . For factors of type  $\text{II}_1$  the values span the range  $[0, 1]$  and for factors of type  $\text{II}_\infty$  in the range  $[0, \infty)$ . For factors of type III the values of the trace are  $0$ , and  $\infty$ .

### Tomita-Takesaki theory

Tomita-Takesaki theory is a vital part of the theory of factors. First some definitions.

1. Let  $\omega(x)$  be a faithful state of von Neumann algebra so that one has  $\omega(xx^*) > 0$  for  $x > 0$ . Assume by Riesz lemma the representation of  $\omega$  as a vacuum expectation value:  $\omega = (\cdot\Omega, \Omega)$ , where  $\Omega$  is cyclic and separating state.
2. Let

$$L^\infty(\mathcal{M}) \equiv \mathcal{M} \quad , \quad L^2(\mathcal{M}) = \mathcal{H} \quad , \quad L^1(\mathcal{M}) = \mathcal{M}_* \quad , \quad (6.2.1)$$

where  $\mathcal{M}_*$  is the pre-dual of  $\mathcal{M}$  defined by linear functionals in  $\mathcal{M}$ . One has  $\mathcal{M}_*^* = \mathcal{M}$ .

3. The conjugation  $x \rightarrow x^*$  is isometric in  $\mathcal{M}$  and defines a map  $\mathcal{M} \rightarrow L^2(\mathcal{M})$  via  $x \rightarrow x\Omega$ . The map  $S_0: x\Omega \rightarrow x^*\Omega$  is however non-isometric.

4. Denote by  $S$  the closure of the anti-linear operator  $S_0$  and by  $S = J\Delta^{1/2}$  its polar decomposition analogous that for complex number and generalizing polar decomposition of linear operators by replacing (almost) unitary operator with anti-unitary  $J$ . Therefore  $\Delta = S^*S > 0$  is positive self-adjoint and  $J$  an anti-unitary involution. The non-triviality of  $\Delta$  reflects the fact that the state is not trace so that hermitian conjugation represented by  $S$  in the state space brings in additional factor  $\Delta^{1/2}$ .
5. What  $x$  can be is puzzling to physicists. The restriction fermionic Fock space and thus to creation operators would imply that  $\Delta$  would act non-trivially only vacuum state so that  $\Delta > 0$  condition would not hold true. The resolution of puzzle is the allowance of tensor product of Fock spaces for which vacua are conjugates: only this gives cyclic and separating state. This is natural in zero energy ontology.

The basic results of Tomita-Takesaki theory are following.

1. The basic result can be summarized through the following formulas

$$\Delta^{it}M\Delta^{-it} = \mathcal{M} \quad , \quad JMJ = \mathcal{M}' \quad .$$

2. The latter formula implies that  $\mathcal{M}$  and  $\mathcal{M}'$  are isomorphic algebras. The first formula implies that a one parameter group of modular automorphisms characterizes partially the factor. The physical meaning of modular automorphisms is discussed in [?, ?]  $\Delta$  is Hermitian and positive definite so that the eigenvalues of  $\log(\Delta)$  are real but can be negative.  $\Delta^{it}$  is however not unitary for factors of type II and III. Physically the non-unitarity must relate to the fact that the flow is contracting so that hermiticity as a local condition is not enough to guarantee unitarity.
3.  $\omega \rightarrow \sigma_t^\omega = Ad\Delta^{it}$  defines a canonical evolution -modular automorphism- associated with  $\omega$  and depending on it. The  $\Delta$ :s associated with different  $\omega$ :s are related by a unitary inner automorphism so that their equivalence classes define an invariant of the factor.

Tomita-Takesaki theory gives rise to a non-commutative measure theory which is highly non-trivial. In particular the spectrum of  $\Delta$  can be used to classify the factors of type II and III.

### Modular automorphisms

Modular automorphisms of factors are central for their classification.

1. One can divide the automorphisms to inner and outer ones. Inner automorphisms correspond to unitary operators obtained by exponentiating Hermitian Hamiltonian belonging to the factor and connected to identity by a flow. Outer automorphisms do not allow a representation as a unitary transformations although  $\log(\Delta)$  is formally a Hermitian operator.
2. The fundamental group of the type  $II_1$  factor defined as fundamental group group of corresponding  $II_\infty$  factor characterizes partially a factor of type  $II_1$ . This group consists real numbers  $\lambda$  such that there is an automorphism scaling the trace by  $\lambda$ . Fundamental group typically contains all reals but it can be also discrete and even trivial.
3. Factors of type III allow a one-parameter group of modular automorphisms, which can be used to achieve a partial classification of these factors. These automorphisms define a flow in the center of the factor known as flow of weights. The set of parameter values  $\lambda$  for which  $\omega$  is mapped to itself and the center of the factor defined by the identity operator (projector to the factor as a sub-algebra of  $\mathcal{B}(\mathcal{H})$ ) is mapped to itself in the modular automorphism defines the Connes spectrum of the factor. For factors of type  $III_\lambda$  this set consists of powers of  $\lambda < 1$ . For factors of type  $III_0$  this set contains only identity automorphism so that there is no periodicity. For factors of type  $III_1$  Connes spectrum contains all real numbers so that the automorphisms do not affect the identity operator of the factor at all.

The modules over a factor correspond to separable Hilbert spaces that the factor acts on. These modules can be characterized by M-dimension. The idea is roughly that complex rays are replaced by the sub-spaces defined by the action of  $\mathcal{M}$  as basic units. M-dimension is not integer valued in general. The so called standard module has a cyclic separating vector and each factor has a standard representation possessing antilinear involution  $J$  such that  $\mathcal{M}' = J\mathcal{M}J$  holds true (note that  $J$  changes the order of the operators in conjugation). The inclusions of factors define modules having interpretation in terms of a finite measurement resolution defined by  $\mathcal{M}$ .

### Crossed product as a manner to construct factors of type III

By using so called crossed product [?] for a group  $G$  acting in algebra  $A$  one can obtain new von Neumann algebras. One ends up with crossed product by a two-step generalization by starting from the semidirect product  $G \triangleleft H$  for groups defined as  $(g_1, h_1)(g_2, h_2) = (g_1 h_1(g_2), h_1 h_2)$  (note that Poincare group has interpretation as a semidirect product  $M^4 \triangleleft SO(3, 1)$  of Lorentz and translation groups). At the first step one replaces the group  $H$  with its group algebra. At the second step the the group algebra is replaced with a more general algebra. What is formed is the semidirect product  $A \triangleleft G$  which is sum of algebras  $Ag$ . The product is given by  $(a_1, g_1)(a_2, g_2) = (a_1 g_1(a_2), g_1 g_2)$ . This construction works for both locally compact groups and quantum groups. A not too highly educated guess is that the construction in the case of quantum groups gives the factor  $\mathcal{M}$  as a crossed product of the included factor  $\mathcal{N}$  and quantum group defined by the factor space  $\mathcal{M}/\mathcal{N}$ .

The construction allows to express factors of type III as crossed products of factors of type  $II_\infty$  and the 1-parameter group  $G$  of modular automorphisms assignable to any vector which is cyclic for both factor and its commutant. The ergodic flow  $\theta_\lambda$  scales the trace of projector in  $II_\infty$  factor by  $\lambda > 0$ . The dual flow defined by  $G$  restricted to the center of  $II_\infty$  factor does not depend on the choice of cyclic vector.

The Connes spectrum - a closed subgroup of positive reals - is obtained as the exponent of the kernel of the dual flow defined as set of values of flow parameter  $\lambda$  for which the flow in the center is trivial. Kernel equals to  $\{0\}$  for  $III_0$ , contains numbers of form  $\log(\lambda)Z$  for factors of type  $III_\lambda$  and contains all real numbers for factors of type  $III_1$  meaning that the flow does not affect the center.

### 6.2.2 Inclusions and Connes tensor product

Inclusions  $\mathcal{N} \subset \mathcal{M}$  of von Neumann algebras have physical interpretation as a mathematical description for sub-system-system relation. In [K82] there is more extensive TGD colored description of inclusions and their role in TGD. Here only basic facts are listed and the Connes tensor product is explained.

For type I algebras the inclusions are trivial and tensor product description applies as such. For factors of  $II_1$  and  $III$  the inclusions are highly non-trivial. The inclusion of type  $II_1$  factors were understood by Vaughan Jones [?] and those of factors of type  $III$  by Alain Connes [?].

Formally sub-factor  $\mathcal{N}$  of  $\mathcal{M}$  is defined as a closed \*-stable C-subalgebra of  $\mathcal{M}$ . Let  $\mathcal{N}$  be a sub-factor of type  $II_1$  factor  $\mathcal{M}$ . Jones index  $\mathcal{M} : \mathcal{N}$  for the inclusion  $\mathcal{N} \subset \mathcal{M}$  can be defined as  $\mathcal{M} : \mathcal{N} = \dim_{\mathcal{N}}(L^2(\mathcal{M})) = \text{Tr}_{\mathcal{N}'}(id_{L^2(\mathcal{M})})$ . One can say that the dimension of completion of  $\mathcal{M}$  as  $\mathcal{N}$  module is in question.

#### Basic findings about inclusions

What makes the inclusions non-trivial is that the position of  $\mathcal{N}$  in  $\mathcal{M}$  matters. This position is characterized in case of hyper-finite  $II_1$  factors by index  $\mathcal{M} : \mathcal{N}$  which can be said to the dimension of  $\mathcal{M}$  as  $\mathcal{N}$  module and also as the inverse of the dimension defined by the trace of the projector from  $\mathcal{M}$  to  $\mathcal{N}$ . It is important to notice that  $\mathcal{M} : \mathcal{N}$  does not characterize either  $\mathcal{M}$  or  $\mathcal{N}$ , only the imbedding.

The basic facts proved by Jones are following [?].

1. For pairs  $\mathcal{N} \subset \mathcal{M}$  with a finite principal graph the values of  $\mathcal{M} : \mathcal{N}$  are given by

$$\begin{aligned} a) \quad \mathcal{M} : \mathcal{N} &= 4\cos^2(\pi/h) \quad , \quad h \geq 3 \quad , \\ b) \quad \mathcal{M} : \mathcal{N} &\geq 4 \quad . \end{aligned} \tag{6.2.2}$$

the numbers at right hand side are known as Beraha numbers [?] . The comments below give a rough idea about what finiteness of principal graph means.

- As explained in [?] , for  $\mathcal{M} : \mathcal{N} < 4$  one can assign to the inclusion Dynkin graph of ADE type Lie-algebra  $g$  with  $h$  equal to the Coxeter number  $h$  of the Lie algebra given in terms of its dimension and dimension  $r$  of Cartan algebra  $r$  as  $h = (\dim g - r)/r$ . The Lie algebras of  $SU(n)$ ,  $E_7$  and  $D_{2n+1}$  are however not allowed. For  $\mathcal{M} : \mathcal{N} = 4$  one can assign to the inclusion an extended Dynkin graph of type ADE characterizing Kac Moody algebra. Extended ADE diagrams characterize also the subgroups of  $SU(2)$  and the interpretation proposed in [?] is following. The ADE diagrams are associated with the  $n = \infty$  case having  $\mathcal{M} : \mathcal{N} \geq 4$ . There are diagrams corresponding to infinite subgroups:  $SU(2)$  itself, circle group  $U(1)$ , and infinite dihedral groups (generated by a rotation by a non-rational angle and reflection. The diagrams corresponding to finite subgroups are extension of  $A_n$  for cyclic groups, of  $D_n$  dihedral groups, and of  $E_n$  with  $n=6,7,8$  for tetrahedron, cube, dodecahedron. For  $\mathcal{M} : \mathcal{N} < 4$  ordinary Dynkin graphs of  $D_{2n}$  and  $E_6, E_8$  are allowed.

### Connes tensor product

The inclusions The basic idea of Connes tensor product is that a sub-space generated sub-factor  $\mathcal{N}$  takes the role of the complex ray of Hilbert space. The physical interpretation is in terms of finite measurement resolution: it is not possible to distinguish between states obtained by applying elements of  $\mathcal{N}$ .

Intuitively it is clear that it should be possible to decompose  $\mathcal{M}$  to a tensor product of factor space  $\mathcal{M}/\mathcal{N}$  and  $\mathcal{N}$ :

$$\mathcal{M} = \mathcal{M}/\mathcal{N} \otimes \mathcal{N} . \quad (6.2.3)$$

One could regard the factor space  $\mathcal{M}/\mathcal{N}$  as a non-commutative space in which each point corresponds to a particular representative in the equivalence class of points defined by  $\mathcal{N}$ . The connections between quantum groups and Jones inclusions suggest that this space closely relates to quantum groups. An alternative interpretation is as an ordinary linear space obtained by mapping  $\mathcal{N}$  rays to ordinary complex rays. These spaces appear in the representations of quantum groups. Similar procedure makes sense also for the Hilbert spaces in which  $\mathcal{M}$  acts.

Connes tensor product can be defined in the space  $\mathcal{M} \otimes \mathcal{M}$  as entanglement which effectively reduces to entanglement between  $\mathcal{N}$  sub-spaces. This is achieved if  $\mathcal{N}$  multiplication from right is equivalent with  $\mathcal{N}$  multiplication from left so that  $\mathcal{N}$  acts like complex numbers on states. One can imagine variants of the Connes tensor product and in TGD framework one particular variant appears naturally as will be found.

In the finite-dimensional case Connes tensor product of Hilbert spaces has a rather simple representation. If the matrix algebra  $N$  of  $n \times n$  matrices acts on  $V$  from right,  $V$  can be regarded as a space formed by  $m \times n$  matrices for some value of  $m$ . If  $N$  acts from left on  $W$ ,  $W$  can be regarded as space of  $n \times r$  matrices.

- In the first representation the Connes tensor product of spaces  $V$  and  $W$  consists of  $m \times r$  matrices and Connes tensor product is represented as the product  $VW$  of matrices as  $(VW)_{mr} e^{mr}$ . In this representation the information about  $N$  disappears completely as the interpretation in terms of measurement resolution suggests. The sum over intermediate states defined by  $N$  brings in mind path integral.
- An alternative and more physical representation is as a state

$$\sum_n V_{mn} W_{nr} e^{mn} \otimes e^{nr}$$

in the tensor product  $V \otimes W$ .

3. One can also consider two spaces  $V$  and  $W$  in which  $N$  acts from right and define Connes tensor product for  $A^\dagger \otimes_N B$  or its tensor product counterpart. This case corresponds to the modification of the Connes tensor product of positive and negative energy states. Since Hermitian conjugation is involved, matrix product does not define the Connes tensor product now. For  $m = r$  case entanglement coefficients should define a unitary matrix commuting with the action of the Hermitian matrices of  $N$  and interpretation would be in terms of symmetry. HFF property would encourage to think that this representation has an analog in the case of HFFs of type  $II_1$ .
4. Also type  $I_n$  factors are possible and for them Connes tensor product makes sense if one can assign the inclusion of finite-D matrix algebras to a measurement resolution.

### 6.2.3 Factors in quantum field theory and thermodynamics

Factors arise in thermodynamics and in quantum field theories [?, ?, ?]. There are good arguments showing that in HFFs of  $III_1$  appear are relativistic quantum field theories. In non-relativistic QFTs the factors of type I appear so that the non-compactness of Lorentz group is essential. Factors of type  $III_1$  and  $III_\lambda$  appear also in relativistic thermodynamics.

The geometric picture about factors is based on open subsets of Minkowski space. The basic intuitive view is that for two subsets of  $M^4$ , which cannot be connected by a classical signal moving with at most light velocity, the von Neumann algebras commute with each other so that  $\vee$  product should make sense.

Some basic mathematical results of algebraic quantum field theory [?] deserve to be listed since they are suggestive also from the point of view of TGD.

1. Let  $\mathcal{O}$  be a bounded region of  $R^4$  and define the region of  $M^4$  as a union  $\cup_{|x|<\epsilon}(\mathcal{O} + x)$  where  $(\mathcal{O} + x)$  is the translate of  $\mathcal{O}$  and  $|x|$  denotes Minkowski norm. Then every projection  $E \in \mathcal{M}(\mathcal{O})$  can be written as  $WW^*$  with  $W \in \mathcal{M}(\mathcal{O}_\epsilon)$  and  $W^*W = 1$ . Note that the union is not a bounded set of  $M^4$ . This almost establishes the type III property.
2. Both the complement of light-cone and double light-cone define HFF of type  $III_1$ . Lorentz boosts induce modular automorphisms.
3. The so called split property suggested by the description of two systems of this kind as a tensor product in relativistic QFTs is believed to hold true. This means that the HFFs of type  $III_1$  associated with causally disjoint regions are sub-factors of factor of type  $I_\infty$ . This means

$$\mathcal{M}_1 \subset \mathcal{B}(\mathcal{H}_1) \times 1 \quad , \quad \mathcal{M}_2 \subset 1 \otimes \mathcal{B}(\mathcal{H}_2) \quad .$$

An infinite hierarchy of inclusions of HFFs of type  $III_1$ s is induced by set theoretic inclusions.

### 6.2.4 TGD and factors

The following vision about TGD and factors relies heavily on zero energy ontology, TGD inspired quantum measurement theory, basic vision about quantum TGD, and bosonic emergence.

#### The problems

Concerning the role of factors in TGD framework there are several problems of both conceptual and technical character.

##### 1. Conceptual problems

It is safest to start from the conceptual problems and take a role of skeptic.

1. Under what conditions the assumptions of Tomita-Takesaki formula stating the existence of modular automorphism and isomorphy of the factor and its commutant hold true? What is the physical interpretation of the formula  $\mathcal{M}' = J\mathcal{M}J$  relating factor and its commutant in TGD framework?

2. Is the identification  $M = \Delta^{it}$  sensible in quantum TGD and zero energy ontology, where M-matrix is "complex square root" of exponent of Hamiltonian defining thermodynamical state and the notion of unitary time evolution is given up? The notion of state  $\omega$  leading to  $\Delta$  is essentially thermodynamical and one can wonder whether one should take also a "complex square root" of  $\omega$  to get M-matrix giving rise to a genuine quantum theory.
3. TGD based quantum measurement theory involves both quantum fluctuating degrees of freedom assignable to light-like 3-surfaces and zero modes identifiable as classical degrees of freedom assignable to interior of the space-time sheet. Zero modes have also fermionic counterparts. State preparation should generate entanglement between the quantal and classical states. What this means at the level of von Neumann algebras?
4. What is the TGD counterpart for causal disjointness. At space-time level different space-time sheets could correspond to such regions whereas at imbedding space level causally disjoint  $CD$ s would represent such regions.

### 2. Technical problems

There are also more technical questions.

1. What is the von Neumann algebra needed in TGD framework? Does one have a direct integral over factors? Which factors appear in it? Can one construct the factor as a crossed product of some group  $G$  with direct physical interpretation and of naturally appearing factor  $A$ ? Is  $A$  a HFF of type  $II_\infty$ ? assignable to a fixed  $CD$ ? What is the natural Hilbert space  $\mathcal{H}$  in which  $A$  acts?
2. What are the geometric transformations inducing modular automorphisms of  $II_\infty$  inducing the scaling down of the trace? Is the action of  $G$  induced by the boosts in Lorentz group. Could also translations and scalings induce the action? What is the factor associated with the union of Poincare transforms of  $CD$ ?  $\log(\Delta)$  is Hermitian algebraically: what does the non-unitarity of  $\exp(\log(\Delta)it)$  mean physically?
3. Could  $\Omega$  correspond to a vacuum which in conformal degrees of freedom depends on the choice of the sphere  $S^2$  defining the radial coordinate playing the role of complex variable in the case of the radial conformal algebra. Does \*-operation in  $\mathcal{M}$  correspond to Hermitian conjugation for fermionic oscillator operators and change of sign of super conformal weights?

The exponent of the modified Dirac action gives rise to the exponent of Kähler function as Dirac determinant and fermionic inner product defined by fermionic Feynman rules. It is implausible that this exponent could as such correspond to  $\omega$  or  $\Delta^{it}$  having conceptual roots in thermodynamics rather than QFT. If one assumes that the exponent of the modified Dirac action defines a "complex square root" of  $\omega$  the situation changes. This raises technical questions relating to the notion of square root of  $\omega$ .

1. Does the complex square root of  $\omega$  have a polar decomposition to a product of positive definite matrix (square root of the density matrix) and unitary matrix and does  $\omega^{1/2}$  correspond to the modulus in the decomposition? Does the square root of  $\Delta$  have similar decomposition with modulus equal equal to  $\Delta^{1/2}$  in standard picture so that modular automorphism, which is inherent property of von Neumann algebra, would not be affected?
2.  $\Delta^{it}$  or rather its generalization is defined modulo a unitary operator defined by some Hamiltonian and is therefore highly non-unique as such. This non-uniqueness applies also to  $|\Delta|$ . Could this non-uniqueness correspond to the thermodynamical degrees of freedom?

### Zero energy ontology and factors

The first question concerns the identification of the Hilbert space associated with the factors in zero energy ontology. As the positive or negative energy part of the zero energy state space or as the entire space of zero energy states? The latter option would look more natural physically and is forced by the condition that the vacuum state is cyclic and separating.

1. The commutant of HFF given as  $\mathcal{M}' = J\mathcal{M}J$ , where  $J$  is involution transforming fermionic oscillator operators and bosonic vector fields to their Hermitian conjugates. Also conformal weights would change sign in the map which conforms with the view that the light-like boundaries of  $CD$  are analogous to upper and lower hemispheres of  $S^2$  in conformal field theory. The presence of  $J$  representing essentially Hermitian conjugation would suggest that positive and zero energy parts of zero energy states are related by this formula so that state space decomposes to a tensor product of positive and negative energy states and  $M$ -matrix can be regarded as a map between these two sub-spaces.
2. The fact that HFF of type  $II_1$  has the algebra of fermionic oscillator operators as a canonical representation makes the situation puzzling for a novice. The assumption that the vacuum is cyclic and separating means that neither creation nor annihilation operators can annihilate it. Therefore Fermionic Fock space cannot appear as the Hilbert space in the Tomita-Takesaki theorem. The paradox is circumvented if the action of  $*$  transforms creation operators acting on the positive energy part of the state to annihilation operators acting on negative energy part of the state. If  $J$  permutes the two Fock vacuums in their tensor product, the action of  $S$  indeed maps permutes the tensor factors associated with  $\mathcal{M}$  and  $\mathcal{M}'$ .

It is far from obvious whether the identification  $M = \Delta^{it}$  makes sense in zero energy ontology.

1. In zero energy ontology  $M$ -matrix defines time-like entanglement coefficients between positive and negative energy parts of the state.  $M$ -matrix is essentially "complex square root" of the density matrix and quantum theory similar square root of thermodynamics. The notion of state as it appears in the theory of HFFS is however essentially thermodynamical. Therefore it is good to ask whether the "complex square root of state" could make sense in the theory of factors.
2. Quantum field theory suggests an obvious proposal concerning the meaning of the square root: one replaces exponent of Hamiltonian with imaginary exponential of action at  $T \rightarrow 0$  limit. In quantum TGD the exponent of modified Dirac action giving exponent of Kähler function as real exponent could be the manner to take this complex square root. Modified Dirac action can therefore be regarded as a "square root" of Kähler action.
3. The identification  $M = \Delta^{it}$  relies on the idea of unitary time evolution which is given up in zero energy ontology based on  $CD$ s? Is the reduction of the quantum dynamics to a flow a realistic idea? As will be found this automorphism could correspond to a time translation or scaling for either upper or lower light-cone defining  $CD$  and can ask whether  $\Delta^{it}$  corresponds to the exponent of scaling operator  $L_0$  defining single particle propagator as one integrates over  $t$ . Its complex square root would correspond to fermionic propagator.
4. In this framework  $J\Delta^{it}$  would map the positive energy and negative energy sectors to each other. If the positive and negative energy state spaces can identified by isometry then  $M = J\Delta^{it}$  identification can be considered but seems unrealistic.  $S = J\Delta^{1/2}$  maps positive and negative energy states to each other: could  $S$  or its generalization appear in  $M$ -matrix as a part which gives thermodynamics? The exponent of the modified Dirac action does not seem to provide thermodynamical aspect and p-adic thermodynamics suggests strongly the presence exponent of  $\exp(-L_0/T_p)$  with  $T_p$  chose in such manner that consistency with p-adic thermodynamics is obtained. Could the generalization of  $J\Delta^{n/2}$  with  $\Delta$  replaced with its "square root" give rise to p-adic thermodynamics and also ordinary thermodynamics at the level of density matrix? The minimal option would be that power of  $\Delta^{it}$  which imaginary value of  $t$  is responsible for thermodynamical degrees of freedom whereas everything else is dictated by the unitary  $S$ -matrix appearing as phase of the "square root" of  $\omega$ .

### Zero modes and factors

The presence of zero modes justifies quantum measurement theory in TGD framework and the relationship between zero modes and HFFS involves further conceptual problems.

1. The presence of zero modes means that one has a direct integral over HFFs labeled by zero modes which by definition do not contribute to the configuration space line element. The realization

of quantum criticality in terms of modified Dirac action [K15] suggests that also fermionic zero mode degrees of freedom are present and correspond to conserved charges assignable to the critical deformations of the pace-time sheets. Induced Kähler form characterizes the values of zero modes for a given space-time sheet and the symplectic group of light-cone boundary characterizes the quantum fluctuating degrees of freedom. The entanglement between zero modes and quantum fluctuating degrees of freedom is essential for quantum measurement theory. One should understand this entanglement.

2. Physical intuition suggests that classical observables should correspond to longer length scale than quantal ones. Hence it would seem that the interior degrees of freedom outside  $CD$  should correspond to classical degrees of freedom correlating with quantum fluctuating degrees of freedom of  $CD$ .
3. Quantum criticality means that modified Dirac action allows an infinite number of conserved charges which correspond to deformations leaving metric invariant and therefore act on zero modes. Does this super-conformal algebra commute with the super-conformal algebra associated with quantum fluctuating degrees of freedom? Could the restriction of elements of quantum fluctuating currents to 3-D light-like 3-surfaces actually imply this commutativity. Quantum holography would suggest a duality between these algebras. Quantum measurement theory suggests even 1-1 correspondence between the elements of the two super-conformal algebras. The entanglement between classical and quantum degrees of freedom would mean that prepared quantum states are created by operators for which the operators in the two algebras are entangled in diagonal manner.
4. The notion of finite measurement resolution has become key element of quantum TGD and one should understand how finite measurement resolution is realized in terms of inclusions of hyper-finite factors for which sub-factor defines the resolution in the sense that its action creates states not distinguishable from each other in the resolution used. The notion of finite measurement resolution suggests that one should speak about entanglement between sub-factors and corresponding sub-spaces rather than between states. Connes tensor product would code for the idea that the action of sub-factors is analogous to that of complex numbers and tracing over sub-factor realizes this idea.
5. Just for fun one can ask whether the duality between zero modes and quantum fluctuating degrees of freedom representing quantum holography could correspond to  $\mathcal{M}' = J\mathcal{M}J$ ? This interpretation must be consistent with the interpretation forced by zero energy ontology. If this crazy guess is correct (very probably not!), both positive and negative energy states would be observed in quantum measurement but in totally different manner. Since this identity would simplify enormously the structure of the theory, it deserves therefore to be shown wrong.

### Crossed product construction in TGD framework

The identification of the von Neumann algebra by crossed product construction is the basic challenge. Consider first the question how HFFs of type  $II_\infty$  emerge, how modular automorphisms act on them, and how one can understand the non-unitary character of the  $\Delta^{it}$  in an apparent conflict with the hermiticity and positivity of  $\Delta$ .

1. The Clifford algebra at a given point of  $WCW(CD)$  (light-like 3-surfaces with ends at the boundaries of  $CD$ ) defines HFF of type  $II_1$  or possibly a direct integral of them. For a given  $CD$  having compact isotropy group  $SO(3)$  leaving the rest frame defined by the tips of  $CD$  invariant the factor defined by Clifford algebra valued fields in  $WCW(CD)$  is most naturally HFF of type  $II_\infty$ . The Hilbert space in which this Clifford algebra acts, consists of spinor fields in  $WCW(CD)$ . Also the symplectic transformations of light-cone boundary leaving light-like 3-surfaces inside  $CD$  can be included to  $G$ . In fact all conformal algebras leaving  $CD$  invariant could be included in  $CD$ .
2. The downwards scalings of the radial coordinate  $r_M$  of the light-cone boundary applied to the basis of  $WCW(CD)$  spinor fields could induce modular automorphism. These scalings reduce the size of the portion of light-cone in which the  $WCW$  spinor fields are non-vanishing



and effectively scale down the size of  $CD$ .  $\exp(iL_0)$  as algebraic operator acts as a phase multiplication on eigen states of conformal weight and therefore as apparently unitary operator. The geometric flow however contracts the  $CD$  so that the interpretation of  $\exp(itL_0)$  as a unitary modular automorphism is not possible. The scaling down of  $CD$  reduces the value of the trace if it involves integral over the boundary of  $CD$ . A similar reduction is implied by the downward shift of the upper boundary of  $CD$  so that also time translations would induce modular automorphism. These shifts seem to be necessary to define rest energies of positive and negative energy parts of the zero energy state.

3. The non-triviality of the modular automorphisms of  $II_\infty$  factor reflects different choices of  $\omega$ . The degeneracy of  $\omega$  could be due to the non-uniqueness of conformal vacuum which is part of the definition of  $\omega$ . The radial Virasoro algebra of light-cone boundary is generated by  $L_n = L_{-n}^*$ ,  $n \neq 0$  and  $L_0 = L_0^*$  and negative and positive frequencies are in asymmetric position. The conformal gauge is fixed by the choice of  $SO(3)$  subgroup of Lorentz group defining the slicing of light-cone boundary by spheres and the tips of  $CD$  fix  $SO(3)$  uniquely. One can however consider also alternative choices of  $SO(3)$  and each corresponds to a slicing of the light-cone boundary by spheres but in general the sphere defining the intersection of the two light-cone does not belong to the slicing. Hence the action of Lorentz transformation inducing different choice of  $SO(3)$  can lead out from the preferred state space so that its representation must be non-unitary unless Virasoro generators annihilate the physical states. The non-vanishing of the conformal central charge  $c$  and vacuum weight  $h$  seems to be necessary and indeed can take place for super-symplectic algebra and Super Kac-Moody algebra since only the differences of the algebra elements are assumed to annihilate physical states.

Modular automorphism of HFFs type  $III_1$  can be induced by several geometric transformations for HFFs of type  $III_1$  obtained using the crossed product construction from  $II_\infty$  factor by extending  $CD$  to a union of its Lorentz transforms.

1. The crossed product would correspond to an extension of  $II_\infty$  by allowing a union of some geometric transforms of  $CD$ . If one assumes that only  $CD$ s for which the distance between tips is quantized in powers of 2, then scalings of either upper or lower boundary of  $CD$  cannot correspond to these transformations. Same applies to time translations acting on either boundary but not to ordinary translations. As found, the modular automorphisms reducing the size of  $CD$  could act in HFF of type  $II_\infty$ .
2. The geometric counterparts of the modular transformations would most naturally correspond to any non-compact one parameter sub-group of Lorentz group as also QFT suggests. The Lorentz boosts would replace the radial coordinate  $r_M$  of the light-cone boundary associated with the radial Virasoro algebra with a new one so that the slicing of light-cone boundary with spheres would be affected and one could speak of a new conformal gauge. The temporal distance between tips of  $CD$  in the rest frame would not be affected. The effect would seem to be however unitary because the transformation does not only modify the states but also transforms  $CD$ .
3. Since Lorentz boosts affect the isotropy group  $SO(3)$  of  $CD$  and thus also the conformal gauge defining the radial coordinate of the light-cone boundary, they affect also the definition of the conformal vacuum so that also  $\omega$  is affected so that the interpretation as a modular automorphism makes sense. The simplistic intuition of the novice suggests that if one allows wave functions in the space of Lorentz transforms of  $CD$ , unitarity of  $\Delta^{it}$  is possible. Note that the hierarchy of Planck constants assigns to  $CD$  preferred  $M^2$  and thus direction of quantization axes of angular momentum and boosts in this direction would be in preferred role.
4. One can also consider the HFF of type  $III_\lambda$  if the radial scalings by negative powers of 2 correspond to the automorphism group of  $II_\infty$  factor as the vision about allowed  $CD$ s suggests.  $\lambda = 1/2$  would naturally hold true for the factor obtained by allowing only the radial scalings. Lorentz boosts would expand the factor to HFF of type  $III_1$ . Why scalings by powers of 2 would give rise to periodicity should be understood.

The identification of  $M$ -matrix as modular automorphism  $\Delta^{it}$ , where  $t$  is complex number having as its real part the temporal distance between tips of  $CD$  quantized as  $2^n$  and temperature as imaginary

part, looks at first highly attractive, since it would mean that  $M$ -matrix indeed exists mathematically. The proposed interpretations of modular automorphisms do not support the idea that they could define the  $S$ -matrix of the theory. In any case, the identification as modular automorphism would not lead to a magic universal formula since arbitrary unitary transformation is involved.

### 6.2.5 Can one identify $M$ -matrix from physical arguments?

Consider next the identification of  $M$ -matrix from physical arguments.

#### Basic physical picture

The following physical picture could help in the attempt to guess what the complex square root of  $\omega$  is and also whether this idea makes sense at all. Consider first quantum TGD proper.

1. The exponent of Kähler function identified as Kähler action for preferred extremals defines the bosonic vacuum functional appearing in the functional integral over  $WCW(CD)$ . The exponent of Kähler function depends on the real part of  $t$  identified as Minkowski distance between the tips of  $CD$ . This dependence is not consistent with the dependence of  $\Delta^{it}$  on  $t$  and the natural interpretation is that the vacuum functional can be included in the definition of the inner product for spinors fields of  $WCW$ . More formally, the exponent of Kähler function defines  $\omega$  in bosonic degrees of freedom.
2. One can assign to the modified Dirac action Dirac determinant identified tentatively as the exponent of Kähler function. This determinant is defined as the product of the generalized eigenvalues of a 3-dimensional modified Dirac operator assignable to light-like 3-surfaces. The definition relies on quantum holography involving the slicing of space-time surface both by light-like 3-surfaces and by string world sheets. Hence also Kähler coupling strength follows as a prediction so that the theory involves therefore no free coupling parameters. Kähler function is defined only apart from an additive term which is sum of holomorphic and anti-holomorphic functions of the configuration space and this would naturally correspond to the effect of the modular automorphism. I have proposed that the choices of a particular light-like 3-surface in the slicing of  $X^4$  by light-like 3-surfaces at which vacuum functional is defined as Dirac determinant can differ by this kind of term having therefore interpretation also as a modular automorphism for a factor of type  $II_\infty$ .
3. Quantum criticality -implied by the condition that the modified Dirac action gives rise to conserved currents assignable to the deformations of the space-time surface - means the vanishing of the second variation of Kähler action for these deformations. Preferred extremals correspond to these 4-surfaces and  $M^8 - M^4 \times CP_2$  duality allows to identify them also as hyper-quaternionic space-time surfaces.
4. Second quantized spinor fields are the only quantum fields appearing at the space-time level. This justifies to the notion of bosonic emergence [?], which means that gauge bosons and possible counterpart of Higgs particle are identified as bound states of fermion and antifermion at opposite light-like throats of wormhole contact. This suggests that the  $M$ -matrix should allow a formulation solely in terms of the modified Dirac action.

#### HFFs and the definition of Dirac determinant

The definition of the Dirac determinant -call it  $det(D)$ - discussed in [K15] involves two assumptions. First, finite measurement resolution is assumed to correspond to a replacement of light-like 3-surfaces with braids whose strands carry fermion number. Secondly, the quantum holography justifies the assumption about dimensional reduction to a determinant assignable to 3-D Dirac operator.

1. The finiteness of the trace for HFF of type  $II_1$  indeed encourages the question whether one could define  $det(D)$  as the exponent of the trace of the logarithm of 3-D Dirac operator  $D_3$  even without the assumption of finite measurement resolution. The trace would be induced from the trace of the tensor product of hyper-finite factor of type  $II_1$  and factor of type I.

2. One might wonder whether holography could allow to define  $\det(D)$  also in terms of the 4-D modified Dirac operator. The basic problem is of course that only the spinor fields satisfying  $D_4\Psi = 0$  are allowed and eigenvalue equation in standard sense breaks baryon and lepton number conservation. The critical deformation representing zero modes might however allow to circumvent this difficulty. The modified Dirac equation  $D\Psi = 0$  holding true for the 4-surfaces obtained as critical deformations can be written in the form  $D_0\Psi = D_0\delta\Psi = -\delta D\Psi$ , where the subscript  $_0$  refers to the non-deformed surface and one has  $\delta\Psi = O\Psi_0$  which involves propagator defined by  $D_4$ . Maybe one could define  $\det(D)$  as the determinant of the operator  $-\delta D$  by identifying it as the exponent of the trace of the operator  $\log(-\delta D)$ . This would require a division by the deformation parameter  $\delta t$  at both sides of the modified Dirac equation and means only the elimination of an infinite proportionality factor from the determinant.

### Bosonic emergence and QFT limit of TGD

The QFT limit of TGD gives further valuable hints about the formulation of quantum TGD proper. In QFT limit Dirac action coupled to gauge potentials (and possibly the TGD counterpart of Higgs) defines the theory and bosonic propagators and vertices involving bosons as external particles emerge as radiative corrections [?]. There are no free coupling constants in the theory.

1. The construction involves at the first step the coupling of spinor fields  $\Psi$  to fermionic sources  $\xi$  leading to an expression of the effective action as a functional of gauge potentials and  $\xi$  containing the counterpart of YM action in the purely bosonic sector plus interaction terms representing N-boson vertices. Bosonic dynamics is therefore generated purely radiatively in accordance with the emergence idea. At the next step the coupling to external YM currents leads to Feynman rules in the standard manner.
2. The inverse of the bosonic propagator and N-boson vertices correspond to fermionic loops and coupling constants are predicted completely in terms of them provided one can define the loop integrals uniquely.
3. Fermionic loops do not make sense without cutoff in both mass squared and hyperbolic angle defining the maximum Lorentz boost which can be applied to a virtual fermion in the rest system of the virtual gauge boson. Zero energy ontology realized in terms of a hierarchy of *CDs* provides a physical justification for the hierarchy of hyperbolic cutoffs. p-Adic length scale hypothesis (the sizes of *CDs* come in powers of 2) allows to decompose momentum space to shells corresponding to mass squared intervals  $[n, n + 1)$  using  $CP_2$  mass squared as a unit. The hyperbolic cutoff can depend on p-adic mass scale and can differ for time-like and space-like momenta: the relationship between these cutoffs is fixed from the condition that gauge bosons do not generate mass radiatively. One can find a simple ansatz for the hyperbolic cutoff consistent with the coupling constant evolution in standard model. The vanishing of all on-mass-shell  $N > 2$ -boson vertices defined by the fermionic loops states their irreducibility to lower vertices and serves as a candidate for the condition fixing the hyperbolic cutoff as a function of the p-adic mass scale.

### A proposal for *M*-matrix

This picture can be taken as a template as one tries to imagine how the construction of *M*-matrix could proceed in quantum TGD proper.

1. Modified Dirac action should replace the ordinary Dirac action and define the theory. The linear couplings of spinors to fermionic external currents are needed. Also bosons represented as bound states of fermion and antifermion to the analogs of gauge currents are needed to construct the *M*-matrix and would correspond to an addition of quantum part to induced spinor connection. One can consider also the addition of quantum parts to the induced metric and induced gamma matrices.
2. The couplings of the induced spinor fields to external sources would be given as contractions of the fermionic sources with conformal super-currents. Conformal currents would couple to bosonic external currents analogous to external YM currents and *M*-matrix would result via

the usual procedure leading to generalized Feynman diagrams for which sub- $CD$ s would contain vertices.

One cannot however argue that everything would be crystal clear.

1. There are two kinds of super-conformal algebras corresponding to quantum fluctuating degrees of freedom and zero modes. The super-conformal algebra associated with the zero modes follows from quantum criticality guaranteeing the conservation of these currents. These currents are defined in the interior of the space-time surface. By quantum holography the quantum fluctuating super-conformal algebra is assigned with light-like 3-surfaces. Both these algebras form a hierarchy of inclusions identifiable as counterparts for inclusions of HFFs. Which of the two super-conformal algebras one should use? Does quantum holography - interpreted as possibility of 1-1 entanglement between the two kinds of conformal currents for prepared states- mean that one can use either of them to construct  $M$ -matrix? How the dimensional reduction could be understood in terms of this duality?
2. The bosonic conserved currents in the interior of  $X^4$  implied by quantum criticality involve a purely local pairing of the induced spinor field and its conjugate. The problem is that gauge bosons as wormhole throats appearing in the dimensionally reduced description correspond to a non-local (in  $CP_2$  scale) pairing of spinor field and its conjugate at opposite wormhole throats. Should one accept as a fact that dimensionally reduced quantum fluctuating counterparts for the purely local zero mode currents are bi-local?
3. Only few days after posing these questions a plausible answer to them came through a resolution of several problems related to the formulation of quantum TGD (see the section "Handful of problems with a common resolution" of [?]). One important outcome of the formulation allowing to understand how stringy fermionic propagators emerge from the theory was that gravitational coupling vanishes for purely local composites of fermion and antifermion represented by Kac-Moody algebra and super-conformal algebra associated with critical deformations. Hence the only sensible identification of bosons seems to be as wormhole throats.
4. The construction of the bosonic propagators in terms of fermionic loops [?] as functionals integral over Grassmann variables generalizes. Fermionic loops correspond geometrically to wormhole contacts having fermion and anti-fermion at their opposite light-like throats. This implies a cutoff for momentum squared and hyperbolic angle of the virtual fermion in the rest system of boson crucial for the absence of loop divergences. Hence bosonic propagation is emergent as is also fermionic propagation which can be seen as induced by the measurement interaction for momentum. This justifies the cutoffs due to the finite measurement resolution.
5. It is essential that one first functionally integrates over the fermionic degrees of freedom and over the small deformations of light-like 3-surfaces and only after that constructs diagrams from tree diagrams with bosonic and fermionic lines by using generalized Cutkosky rules. Here the generalization of twistors to 8-D context allowing to regard massive particles as massless particles in 8-D framework is expected to be a crucial technical tool possibly allowing to achieve summations over large classes of generalized Feynman diagrams. Also the hierarchy of  $CD$ s is expected to be crucial in the construction.

The key idea is the addition of measurement interaction term to the modified Dirac action coupling to the conserved currents defined by quantum critical deformations for which the second variation of Kähler action vanishes. There remains a considerable freedom in choosing the precise form of the measurement interaction but there is a long list of arguments supporting the identification of the measurement interaction as the one defined by 3-D Chern-Simons term assignable with wormhole throats so that the dynamics in the interior of space-time sheet is not affected. This means that 3-D light-like wormhole throats carry induced spinor field which can be regarded as independent degrees of freedom having the spinor fields at partonic 2-surfaces as sources and acting as 3-D sources for the 4-D induced spinor field. The most general measurement interaction would involve the corresponding coupling also for Kähler action but is not physically motivated. Here are the arguments in favor of Chern-Simons Dirac action and corresponding measurement interaction.

1. A correlation between 4-D geometry of space-time sheet and quantum numbers is achieved by the identification of exponent of Kähler function as Dirac determinant making possible the entanglement of classical degrees of freedom in the interior of space-time sheet with quantum numbers.
2. Cartan algebra plays a key role not only at quantum level but also at the level of space-time geometry since quantum critical conserved currents vanish for Cartan algebra of isometries and the measurement interaction terms giving rise to conserved currents are possible only for Cartan algebras. Furthermore, modified Dirac equation makes sense only for eigen states of Cartan algebra generators. The hierarchy of Planck constants realized in terms of the book like structure of the generalized imbedding space assigns to each  $CD$  (causal diamond) preferred Cartan algebra: in case of Poincare algebra there are two of them corresponding to linear and cylindrical  $M^4$  coordinates.
3. Quantum holography and dimensional reduction hierarchy in which partonic 2-surface defined fermionic sources for 3-D fermionic fields at light-like 3-surfaces  $Y_l^3$  in turn defining fermionic sources for 4-D spinors find an elegant realization. Effective 2-dimensionality is achieved if the replacement of light-like wormhole throat  $X_l^3$  with light-like 3-surface  $Y_l^3$  "parallel" with it in the definition of Dirac determinant corresponds to the  $U(1)$  gauge transformation  $K \rightarrow K + f + \bar{f}$  for Kähler function of WCW so that WCW Kähler metric is not affected. Here  $f$  is holomorphic function of WCW ("world of classical worlds") complex coordinates and arbitrary function of zero mode coordinates.
4. An elegant description of the interaction between super-conformal representations realized at partonic 2-surfaces and dynamics of space-time surfaces is achieved since the values of Cartan charges are feeded to the 3-D Dirac equation which also receives mass term at the same time. Almost topological QFT at wormhole throats results at the limit when four-momenta vanish: this is in accordance with the original vision about TGD as almost topological QFT.
5. A detailed view about the physical role of quantum criticality results. Quantum criticality fixes the values of Kähler coupling strength as the analog of critical temperature. Quantum criticality implies that second variation of Kähler action vanishes for critical deformations and the existence of conserved current except in the case of Cartan algebra of isometries. Quantum criticality allows to fix the values of couplings appearing in the measurement interaction by using the condition  $K \rightarrow K + f + \bar{f}$ . p-Adic coupling constant evolution can be understood also and corresponds to scale hierarchy for the sizes of causal diamonds ( $CDs$ ). To achieve internal consistency the quantum critical deformations for Kähler action must be also quantum critical for Chern-Simons action which implies that the deformations are orthogonal to Kähler magnetic field at each light-like 3-surface in the slicing of space-time sheet by light-like 3-surfaces.
6. CP breaking, irreversibility and the space-time description of dissipation are closely related. Also the interpretation of preferred extremals of Kähler action in regions where  $[D_{C-S}, D_{C-S,int}] = 0$  as asymptotic self organization patterns makes sense. Here  $D_{C-S}$  denotes the 3-D modified Dirac operator associated with Chern-Simons action and  $D_{C-S,int}$  to the corresponding measurement interaction term expressible as superposition of couplings to various observables to critical conserved currents.
7. A radically new view about matter antimatter asymmetry based on zero energy ontology emerges and one could understand the experimental absence of antimatter as being due to the fact antimatter corresponds to negative energy states. The identification of bosons as wormhole contacts is the only possible option in this framework.
8. Almost stringy propagators and a consistency with the identification of wormhole throats as lines of generalized Feynman diagrams is achieved. The notion of bosonic emergence leads to a long sought general master formula for the  $M$ -matrix elements. The counterpart for fermionic loop defining bosonic inverse propagator at QFT limit is wormhole contact with fermion and cutoffs in mass squared and hyperbolic angle for loop momenta of fermion and antifermion in the rest system of emitting boson have precise geometric counterpart.

On basis of above considerations it seems that the idea about "complex square root" of  $\omega$  might make sense in quantum TGD and that different measurement interactions correspond to various choices of  $\omega$ . Also the modular automorphism would make sense and because of its non-uniqueness  $\Delta$  could bring in the flexibility needed one wants thermodynamics. Stringy picture forces to ask whether  $\Delta$  could in some situation be proportional  $\exp(L_0)$ , where  $L_0$  represents as the infinitesimal scaling generator of either super-symplectic algebra or super Kac-Moody algebra (the choice does not matter since the differences of the generators annihilate physical states in coset construction). This would allow to reproduce real thermodynamics consistent with p-adic thermodynamics.

In string models  $\exp(iL_0\tau)$  is identified as the time evolution operator at single particle level whose integral over  $\tau$  defines the propagator. The quantization for the sizes of  $CD$ s does not however allow integration over  $t$  in this sense. Could the integration over projectors with traces differing by scalings parameterized by  $t$  correspond to this integral? Or should one give up this idea since modified Dirac operator defines a propagator in any case?

### 6.2.6 Finite measurement resolution and HFFs

The finite resolution of quantum measurement leads in TGD framework naturally to the notion of quantum  $M$ -matrix for which elements have values in sub-factor  $\mathcal{N}$  of HFF rather than being complex numbers.  $M$ -matrix in the factor space  $\mathcal{M}/\mathcal{N}$  is obtained by tracing over  $\mathcal{N}$ . The condition that  $\mathcal{N}$  acts like complex numbers in the tracing implies that  $M$ -matrix elements are proportional to maximal projectors to  $\mathcal{N}$  so that  $M$ -matrix is effectively a matrix in  $\mathcal{M}/\mathcal{N}$  and situation becomes finite-dimensional. It is still possible to satisfy generalized unitarity conditions but in general case tracing gives a weighted sum of unitary  $M$ -matrices defining what can be regarded as a square root of density matrix.

#### About the notion of observable in zero energy ontology

Some clarifications concerning the notion of observable in zero energy ontology are in order.

1. As in standard quantum theory observables correspond to hermitian operators acting on either positive or negative energy part of the state. One can indeed define hermitian conjugation for positive and negative energy parts of the states in standard manner.
2. Also the conjugation  $A \rightarrow JAJ$  is analogous to hermitian conjugation. It exchanges the positive and negative energy parts of the states also maps the light-like 3-surfaces at the upper boundary of  $CD$  to the lower boundary and vice versa. The map is induced by time reflection in the rest frame of  $CD$  with respect to the origin at the center of  $CD$  and has a well defined action on light-like 3-surfaces and space-time surfaces. This operation cannot correspond to the sought for hermitian conjugation since  $JAJ$  and  $A$  commute. The formulation of quantum TGD in terms of the modified Dirac action requires the addition of CP and T breaking fermionic counterpart of instanton term to the modified Dirac action. An interesting question is what this term means from the point of view of the conjugation.
3. Zero energy ontology gives Cartan sub-algebra of the Lie algebra of symmetries a special status. Only Cartan algebra acting on either positive or negative states respects the zero energy property but this is enough to define quantum numbers of the state. In absence of symmetry breaking positive and negative energy parts of the state combine to form a state in a singlet representation of group. Since only the net quantum numbers must vanish zero energy ontology allows a symmetry breaking respecting a chosen Cartan algebra.
4. In order to speak about four-momenta for positive and negative energy parts of the states one must be able to define how the translations act on  $CD$ s. The most natural action is a shift of the upper (lower) tip of  $CD$ . In the scale of entire  $CD$  this transformation induced Lorentz boost fixing the other tip. The value of mass squared is identified as proportional to the average of conformal weight in p-adic thermodynamics for the scaling generator  $L_0$  for either super-symplectic or Super Kac-Moody algebra.

### Inclusion of HFFS as characterizer of finite measurement resolution at the level of $S$ -matrix

The inclusion  $\mathcal{N} \subset \mathcal{M}$  of factors characterizes naturally finite measurement resolution. This means following things.

1. Complex rays of state space resulting usually in an ideal state function reduction are replaced by  $\mathcal{N}$ -rays since  $\mathcal{N}$  defines the measurement resolution and takes the role of complex numbers in ordinary quantum theory so that non-commutative quantum theory results. Non-commutativity corresponds to a finite measurement resolution rather than something exotic occurring in Planck length scales. The quantum Clifford algebra  $\mathcal{M}/\mathcal{N}$  creates physical states modulo resolution. The fact that  $\mathcal{N}$  takes the role of gauge algebra suggests that it might be necessary to fix a gauge by assigning to each element of  $\mathcal{M}/\mathcal{N}$  a unique element of  $\mathcal{M}$ . Quantum Clifford algebra with fractal dimension  $\beta = \mathcal{M} : \mathcal{N}$  creates physical states having interpretation as quantum spinors of fractal dimension  $d = \sqrt{\beta}$ . Hence direct connection with quantum groups emerges.
2. The notions of unitarity, hermiticity, and eigenvalue generalize. The elements of unitary and hermitian matrices and  $\mathcal{N}$ -valued. Eigenvalues are Hermitian elements of  $\mathcal{N}$  and thus correspond entire spectra of Hermitian operators. The mutual non-commutativity of eigenvalues guarantees that it is possible to speak about state function reduction for quantum spinors. In the simplest case of a 2-component quantum spinor this means that second component of quantum spinor vanishes in the sense that second component of spinor annihilates physical state and second acts as element of  $\mathcal{N}$  on it. The non-commutativity of spinor components implies correlations between them and thus fractal dimension is smaller than 2.
3. The intuition about ordinary tensor products suggests that one can decompose  $\text{Tr}$  in  $\mathcal{M}$  as

$$\text{Tr}_{\mathcal{M}}(X) = \text{Tr}_{\mathcal{M}/\mathcal{N}} \times \text{Tr}_{\mathcal{N}}(X) . \quad (6.2.4)$$

Suppose one has fixed gauge by selecting basis  $|r_k\rangle$  for  $\mathcal{M}/\mathcal{N}$ . In this case one expects that operator in  $\mathcal{M}$  defines an operator in  $\mathcal{M}/\mathcal{N}$  by a projection to the preferred elements of  $\mathcal{M}$ .

$$\langle r_1 | X | r_2 \rangle = \langle r_1 | \text{Tr}_{\mathcal{N}}(X) | r_2 \rangle . \quad (6.2.5)$$

4. Scattering probabilities in the resolution defined by  $\mathcal{N}$  are obtained in the following manner. The scattering probability between states  $|r_1\rangle$  and  $|r_2\rangle$  is obtained by summing over the final states obtained by the action of  $\mathcal{N}$  from  $|r_2\rangle$  and taking the analog of spin average over the states created in the similar from  $|r_1\rangle$ .  $\mathcal{N}$  average requires a division by  $\text{Tr}(P_{\mathcal{N}}) = 1/\mathcal{M} : \mathcal{N}$  defining fractal dimension of  $\mathcal{N}$ . This gives

$$p(r_1 \rightarrow r_2) = \mathcal{M} : \mathcal{N} \times \langle r_1 | \text{Tr}_{\mathcal{N}}(S P_{\mathcal{N}} S^\dagger) | r_2 \rangle . \quad (6.2.6)$$

This formula is consistent with probability conservation since one has

$$\sum_{r_2} p(r_1 \rightarrow r_2) = \mathcal{M} : \mathcal{N} \times \text{Tr}_{\mathcal{N}}(S S^\dagger) = \mathcal{M} : \mathcal{N} \times \text{Tr}(P_{\mathcal{N}}) = 1 . \quad (6.2.7)$$

5. Unitarity at the level of  $\mathcal{M}/\mathcal{N}$  can be achieved if the unit operator  $Id$  for  $\mathcal{M}$  can be decomposed into an analog of tensor product for the unit operators of  $\mathcal{M}/\mathcal{N}$  and  $\mathcal{N}$  and  $M$  decomposes to a tensor product of unitary M-matrices in  $\mathcal{M}/\mathcal{N}$  and  $\mathcal{N}$ . For HFFs of type II projection operators of  $\mathcal{N}$  with varying traces are present and one expects a weighted sum of unitary M-matrices to result from the tracing having interpretation in terms of square root of thermodynamics.

6. This argument assumes that  $\mathcal{N}$  is HFF of type  $II_1$  with finite trace. For HFFs of type  $III_1$  this assumption must be given up. This might be possible if one compensates the trace over  $\mathcal{N}$  by dividing with the trace of the infinite trace of the projection operator to  $\mathcal{N}$ . This probably requires a limiting procedure which indeed makes sense for HFFs.

### Quantum $M$ -matrix

The description of finite measurement resolution in terms of inclusion  $\mathcal{N} \subset \mathcal{M}$  seems to boil down to a simple rule. Replace ordinary quantum mechanics in complex number field  $C$  with that in  $\mathcal{N}$ . This means that the notions of unitarity, hermiticity, Hilbert space ray, etc.. are replaced with their  $\mathcal{N}$  counterparts.

The full  $M$ -matrix in  $\mathcal{M}$  should be reducible to a finite-dimensional quantum  $M$ -matrix in the state space generated by quantum Clifford algebra  $\mathcal{M}/\mathcal{N}$  which can be regarded as a finite-dimensional matrix algebra with non-commuting  $\mathcal{N}$ -valued matrix elements. This suggests that full  $M$ -matrix can be expressed as  $M$ -matrix with  $\mathcal{N}$ -valued elements satisfying  $\mathcal{N}$ -unitarity conditions.

Physical intuition also suggests that the transition probabilities defined by quantum  $S$ -matrix must be commuting hermitian  $\mathcal{N}$ -valued operators inside every row and column. The traces of these operators give  $\mathcal{N}$ -averaged transition probabilities. The eigenvalue spectrum of these Hermitian matrices gives more detailed information about details below experimental resolution.  $\mathcal{N}$ -hermicity and commutativity pose powerful additional restrictions on the  $M$ -matrix.

Quantum  $M$ -matrix defines  $\mathcal{N}$ -valued entanglement coefficients between quantum states with  $\mathcal{N}$ -valued coefficients. How this affects the situation? The non-commutativity of quantum spinors has a natural interpretation in terms of fuzzy state function reduction meaning that quantum spinor corresponds effectively to a statistical ensemble which cannot correspond to pure state. Does this mean that predictions for transition probabilities must be averaged over the ensemble defined by "quantum quantum states"?

### Quantum fluctuations and inclusions

Inclusions  $\mathcal{N} \subset \mathcal{M}$  of factors provide also a first principle description of quantum fluctuations since quantum fluctuations are by definition quantum dynamics below the measurement resolution. This gives hopes for articulating precisely what the important phrase "long range quantum fluctuations around quantum criticality" really means mathematically.

1. Phase transitions involve a change of symmetry. One might hope that the change of the symmetry group  $G_a \times G_b$  could universally code this aspect of phase transitions. This need not always mean a change of Planck constant but it means always a leakage between sectors of imbedding space. At quantum criticality 3-surfaces would have regions belonging to at least two sectors of  $H$ .
2. The long range of quantum fluctuations would naturally relate to a partial or total leakage of the 3-surface to a sector of imbedding space with larger Planck constant meaning zooming up of various quantal lengths.
3. For  $M$ -matrix in  $\mathcal{M}/\mathcal{N}$  regarded as  $calN$  module quantum criticality would mean a special kind of eigen state for the transition probability operator defined by the  $M$ -matrix. The properties of the number theoretic braids contributing to the  $M$ -matrix should characterize this state. The strands of the critical braids would correspond to fixed points for  $G_a \times G_b$  or its subgroup.

### $M$ -matrix in finite measurement resolution

The following arguments relying on the proposed identification of the space of zero energy states give a precise formulation for  $M$ -matrix in finite measurement resolution and the Connes tensor product involved. The original expectation that Connes tensor product could lead to a unique  $M$ -matrix is wrong. The replacement of  $\omega$  with its complex square root could lead to a unique hierarchy of  $M$ -matrices with finite measurement resolution and allow completely finite theory despite the fact that projectors have infinite trace for HFFs of type  $III_1$ .



1. In zero energy ontology the counterpart of Hermitian conjugation for operator is replaced with  $\mathcal{M} \rightarrow J\mathcal{M}J$  permuting the factors. Therefore  $N \in \mathcal{N}$  acting to positive (negative) energy part of state corresponds to  $N \rightarrow N' = JNJ$  acting on negative (positive) energy part of the state.
2. The allowed elements of  $N$  must be such that zero energy state remains zero energy state. The superposition of zero energy states involved can however change. Hence one must have that the counterparts of complex numbers are of form  $N = JN_1J \vee N_2$ , where  $N_1$  and  $N_2$  have same quantum numbers. A superposition of terms of this kind with varying quantum numbers for positive energy part of the state is possible.
3. The condition that  $N_{1i}$  and  $N_{2i}$  act like complex numbers in  $\mathcal{N}$ -trace means that the effect of  $JN_{1i}J \vee N_{2i}$  and  $JN_{2i}J \vee N_{1i}$  to the trace are identical and correspond to a multiplication by a constant. If  $\mathcal{N}$  is HFF of type  $II_1$  this follows from the decomposition  $\mathcal{M} = \mathcal{M}/\mathcal{N} \otimes \mathcal{N}$  and from  $Tr(AB) = Tr(BA)$  assuming that  $M$  is of form  $M = M_{\mathcal{M}/\mathcal{N}} \times P_{\mathcal{N}}$ . Contrary to the original hopes that Connes tensor product could fix the M-matrix there are no conditions on  $M_{\mathcal{M}/\mathcal{N}}$  which would give rise to a finite-dimensional M-matrix for Jones inclusions. One can replace the projector  $P_{\mathcal{N}}$  with a more general state if one takes this into account in  $*$  operation.
4. In the case of HFFs of type  $III_1$  the trace is infinite so that the replacement of  $Tr_{\mathcal{N}}$  with a state  $\omega_{\mathcal{N}}$  in the sense of factors looks more natural. This means that the counterpart of  $*$  operation exchanging  $N_1$  and  $N_2$  represented as  $SA\Omega = A^*\Omega$  involves  $\Delta$  via  $S = J\Delta^{1/2}$ . The exchange of  $N_1$  and  $N_2$  gives altogether  $\Delta$ . In this case the KMS condition  $\omega_{\mathcal{N}}(AB) = \omega_{\mathcal{N}}(\Delta A)$  guarantees the effective complex number property [?].
5. Quantum TGD more or less requires the replacement of  $\omega$  with its "complex square root" so that also a unitary matrix  $U$  multiplying  $\Delta$  is expected to appear in the formula for  $S$  and guarantee the symmetry. One could speak of a square root of KMS condition [?] in this case. The QFT counterpart would be a cutoff involving path integral over the degrees of freedom below the measurement resolution. In TGD framework it would mean a cutoff in the functional integral over WCW and for the modes of the second quantized induced spinor fields and also cutoff in sizes of causal diamonds. Discretization in terms of braids replacing light-like 3-surfaces should be the counterpart for the cutoff.
6. If one has  $M$ -matrix in  $\mathcal{M}$  expressible as a sum of  $M$ -matrices of form  $M_{\mathcal{M}/\mathcal{N}} \times M_{\mathcal{N}}$  with coefficients which correspond to the square roots of probabilities defining density matrix the tracing operation gives rise to square root of density matrix in  $M$ .

**Is universal M-matrix possible?**

The realization of the finite measurement resolution could apply only to transition probabilities in which  $\mathcal{N}$ -trace or its generalization in terms of state  $\omega_{\mathcal{N}}$  is needed. One might however dream of something more.

1. Maybe there exists a universal M-matrix in the sense that the same M-matrix gives the M-matrices in finite measurement resolution for all inclusions  $\mathcal{N} \subset \mathcal{M}$ . This would mean that one can write

$$M = M_{\mathcal{M}/\mathcal{N}} \otimes M_{\mathcal{N}} \tag{6.2.8}$$

for any physically reasonable choice of  $\mathcal{N}$ . This would formally express the idea that  $M$  is as near as possible to M-matrix of free theory. Also fractality suggests itself in the sense that  $M_{\mathcal{N}}$  is essentially the same as  $M_{\mathcal{M}}$  in the same sense as  $\mathcal{N}$  is same as  $\mathcal{M}$ . It might be that the trivial solution  $M = 1$  is the only possible solution to the condition.

2.  $M_{\mathcal{M}/\mathcal{N}}$  would be obtained by the analog of  $Tr_{\mathcal{N}}$  or  $\omega_{\mathcal{N}}$  operation involving the "complex square root" of the state  $\omega$  in case of HFFs of type  $III_1$ . The QFT counterpart would be path integration over the degrees of freedom below cutoff to get effective action.

3. Universality probably requires assumptions about the thermodynamical part of the universal M-matrix. A possible alternative form of the condition is that it holds true only for canonical choice of "complex square root" of  $\omega$  or for the S-matrix part of  $M$ :

$$S = S_{M/\mathcal{N}} \otimes S_{\mathcal{N}} \quad (6.2.9)$$

for any physically reasonable choice  $\mathcal{N}$ .

4. In TGD framework the condition would say that the M-matrix defined by the modified Dirac action gives M-matrices in finite measurement resolution via the counterpart of integration over the degrees of freedom below the measurement resolution.

An obvious counter argument against the universality is that if the M-matrix is "complex square root of state" cannot be unique and there are infinitely many choices related by a unitary transformation induced by the flows representing modular automorphism giving rise to new choices. This would actually be a well-come result and make possible quantum measurement theory. In the section "Handful of problems with a common resolution" it was found that one must add to the modified Dirac action a measurement interaction term characterizing the measured observables. This implies stringy propagation as well as space-time correlates for quantum numbers characterizing the partonic states. These different modified Dirac actions would give rise to different Kähler functions. The corresponding Kähler metrics would not however differ if the real parts of the Kähler functions associated with the two choices differ by a term  $f(Z) + \overline{f(Z)}$ , where  $Z$  denotes complex coordinates of WCW, the Kähler metric remains the same. The function  $f$  can depend also on zero modes. If this is the case then one can allow in given CD superpositions of WCW spinor fields for which the measurement interactions are different.

### Connes tensor product and space-like entanglement

Ordinary linear Connes tensor product makes sense also in positive/negative energy sector and also now it makes sense to speak about measurement resolution. Hence one can ask whether Connes tensor product should be posed as a constraint on space-like entanglement. The interpretation could be in terms of the formation of bound states. The reducibility of HFFs and inclusions means that the tensor product is not uniquely fixed and ordinary entanglement could correspond to this kind of entanglement.

Also the counterpart of p-adic coupling constant evolution would makes sense. The interpretation of Connes tensor product would be as the variance of the states with respect to some subgroup of  $U(n)$  associated with the measurement resolution: the analog of color confinement would be in question.

### 2-vector spaces and entanglement modulo measurement resolution

John Baez and collaborators [?] are playing with very formal looking formal structures obtained by replacing vectors with vector spaces. Direct sum and tensor product serve as the basic arithmetic operations for the vector spaces and one can define category of n-tuples of vectors spaces with morphisms defined by linear maps between vectors spaces of the tuple. n-tuples allow also element-wise product and sum. They obtain results which make them happy. For instance, the category of linear representations of a given group forms 2-vector spaces since direct sums and tensor products of representations as well as n-tuples make sense. The 2-vector space however looks more or less trivial from the point of physics.

The situation could become more interesting in quantum measurement theory with finite measurement resolution described in terms of inclusions of hyper-finite factors of type  $\text{II}_1$ . The reason is that Connes tensor product replaces ordinary tensor product and brings in interactions via irreducible entanglement as a representation of finite measurement resolution. The category in question could give Connes tensor products of quantum state spaces and describing interactions. For instance, one could multiply  $M$ -matrices via Connes tensor product to obtain category of  $M$ -matrices having also the structure of 2-operator algebra.

1. The included algebra represents measurement resolution and this means that the infinite-D sub-Hilbert spaces obtained by the action of this algebra replace the rays. Sub-factor takes the role of complex numbers in generalized QM so that one obtains non-commutative quantum mechanics. For instance, quantum entanglement for two systems of this kind would not be between rays but between infinite-D subspaces corresponding to sub-factors. One could build a generalization of QM by replacing rays with sub-spaces and it would seem that quantum group concept does more or less this: the states in representations of quantum groups could be seen as infinite-dimensional Hilbert spaces.
2. One could speak about both operator algebras and corresponding state spaces modulo finite measurement resolution as quantum operator algebras and quantum state spaces with fractal dimension defined as factor space like entities obtained from HFF by dividing with the action of included HFF. Possible values of the fractal dimension are fixed completely for Jones inclusions. Maybe these quantum state spaces could define the notions of quantum 2-Hilbert space and 2-operator algebra via direct sum and tensor production operations. Fractal dimensions would make the situation interesting both mathematically and physically.

Suppose one takes the fractal factor spaces as the basic structures and keeps the information about inclusion.

1. Direct sums for quantum vectors spaces would be just ordinary direct sums with HFF containing included algebras replaced with direct sum of included HFFs.
2. The tensor products for quantum state spaces and quantum operator algebras are not anymore trivial. The condition that measurement algebras act effectively like complex numbers would require Connes tensor product involving irreducible entanglement between elements belonging to the two HFFs. This would have direct physical relevance since this entanglement cannot be reduced in state function reduction. The category would defined interactions in terms of Connes tensor product and finite measurement resolution.
3. The sequences of super-conformal symmetry breakings identifiable in terms of inclusions of super-conformal algebras and corresponding HFFs could have a natural description using the 2-Hilbert spaces and quantum 2-operator algebras.

### 6.2.7 Questions about quantum measurement theory in zero energy ontology

#### Fractal hierarchy of state function reductions

In accordance with fractality, the conditions for the Connes tensor product at a given time scale imply the conditions at shorter time scales. On the other hand, in shorter time scales the inclusion would be deeper and would give rise to a larger reducibility of the representation of  $\mathcal{N}$  in  $\mathcal{M}$ . Formally, as  $\mathcal{N}$  approaches to a trivial algebra, one would have a square root of density matrix and trivial  $S$ -matrix in accordance with the idea about asymptotic freedom.

$M$ -matrix would give rise to a matrix of probabilities via the expression  $P(P_+ \rightarrow P_-) = Tr[P_+ M^\dagger P_- M]$ , where  $P_+$  and  $P_-$  are projectors to positive and negative energy energy  $\mathcal{N}$ -rays. The projectors give rise to the averaging over the initial and final states inside  $\mathcal{N}$  ray. The reduction could continue step by step to shorter length scales so that one would obtain a sequence of inclusions. If the  $U$ -process of the next quantum jump can return the  $M$ -matrix associated with  $\mathcal{M}$  or some larger HFF,  $U$  process would be kind of reversal for state function reduction.

Analytic thinking proceeding from vision to details; human life cycle proceeding from dreams and wild actions to the age when most decisions relate to the routine daily activities; the progress of science from macroscopic to microscopic scales; even biological decay processes: all these have an intriguing resemblance to the fractal state function reduction process proceeding to shorter and shorter time scales. Since this means increasing thermality of  $M$ -matrix,  $U$  process as a reversal of state function reduction might break the second law of thermodynamics.

The conservative option would be that only the transformation of intentions to action by  $U$  process giving rise to new zero energy states can bring in something new and is responsible for evolution. The non-conservative option is that the biological death is the  $U$ -process of the next quantum jump leading

to a new life cycle. Breathing would become a universal metaphor for what happens in quantum Universe. The 4-D body would be lived again and again.

### How quantum classical correspondence is realized at parton level?

Quantum classical correspondence must assign to a given quantum state the most probable space-time sheet depending on its quantum numbers. The space-time sheet  $X^4(X^3)$  defined by the Kähler function depends however only on the partonic 3-surface  $X^3$ , and one must be able to assign to a given quantum state the most probable  $X^3$  - call it  $X^3_{max}$  - depending on its quantum numbers.

$X^4(X^3_{max})$  should carry the gauge fields created by classical gauge charges associated with the Cartan algebra of the gauge group (color isospin and hypercharge and electromagnetic and  $Z^0$  charge) as well as classical gravitational fields created by the partons. This picture is very similar to that of quantum field theories relying on path integral except that the path integral is restricted to 3-surfaces  $X^3$  with exponent of Kähler function bringing in genuine convergence and that 4-D dynamics is deterministic apart from the delicacies due to the 4-D spin glass type vacuum degeneracy of Kähler action.

Stationary phase approximation selects  $X^3_{max}$  if the quantum state contains a phase factor depending not only on  $X^3$  but also on the quantum numbers of the state. A good guess is that the needed phase factor corresponds to either Chern-Simons type action or an action describing the interaction of the induced gauge field with the charges associated with the braid strand. This action would be defined for the induced gauge fields. YM action seems to be excluded since it is singular for light-like 3-surfaces associated with the light-like wormhole throats (not only  $\sqrt{\det(g_3)}$  but also  $\sqrt{\det(g_4)}$  vanishes).

The challenge is to show that this is enough to guarantee that  $X^4(X^3_{max})$  carries correct gauge charges. Kind of electric-magnetic duality should relate the normal components  $F_{ni}$  of the gauge fields in  $X^4(X^3_{max})$  to the gauge fields  $F_{ij}$  induced at  $X^3$ . An alternative interpretation is in terms of quantum gravitational holography. The difference between Chern-Simons action characterizing quantum state and the fundamental Chern-Simons type factor associated with the Kähler form would be that the latter emerges as the phase of the Dirac determinant.

One is forced to introduce gauge couplings and also electro-weak symmetry breaking via the phase factor. This is in apparent conflict with the idea that all couplings are predictable. The essential uniqueness of  $M$ -matrix in the case of HFFs of type  $II_1$  (at least) however means that their values as a function of measurement resolution time scale are fixed by internal consistency. Also quantum criticality leads to the same conclusion. Obviously a kind of bootstrap approach suggests itself.

### 6.2.8 How p-adic coupling constant evolution and p-adic length scale hypothesis emerge from quantum TGD proper?

What p-adic coupling constant evolution really means has remained for a long time more or less open. The progress made in the understanding of the  $M$ -matrix of theory has however changed the situation dramatically.

#### $M$ -matrix and coupling constant evolution

The final breakthrough in the understanding of p-adic coupling constant evolution came through the understanding of the  $M$ -matrix defining entanglement coefficients between positive and negative energy parts of zero energy states in zero energy ontology.  $M$ -matrix has interpretation as a "complex square root" of density matrix and thus provides a unification of thermodynamics and quantum theory.  $S$ -matrix is analogous to the phase of Schrödinger amplitude multiplying positive and real square root of density matrix analogous to modulus of Schrödinger amplitude.

The notion of finite measurement resolution realized in terms of inclusions of von Neumann algebras allows to demonstrate that the irreducible components of  $M$ -matrix are unique and possesses huge symmetries in the sense that the hermitian elements of included factor  $\mathcal{N} \subset \mathcal{M}$  defining the measurement resolution act as symmetries of  $M$ -matrix, which suggests a connection with integrable quantum field theories.

It is also possible to understand coupling constant evolution as a discretized evolution associated with time scales  $T_n$ , which come as octaves of a fundamental time scale:  $T_n = 2^n T_0$ . Number theoretic

universality requires that renormalized coupling constants are rational or at most algebraic numbers and this is achieved by this discretization since the logarithms of discretized mass scale appearing in the expressions of renormalized coupling constants reduce to the form  $\log(2^n) = n\log(2)$  and with a proper choice of the coefficient of logarithm  $\log(2)$  dependence disappears so that rational number results. A weaker condition would be  $T_p = pT_0$ ,  $p$  prime, and would assign all  $p$ -adic time scales to the size scale hierarchy of  $CDs$ .

**p-Adic coupling constant evolution**

An attractive conjecture is that the coupling constant evolution associated with  $CDs$  in powers of 2 implying time scale hierarchy  $T_n = 2^n T_0$  induces  $p$ -adic coupling constant evolution and explain why  $p$ -adic length scales correspond to  $L_p \propto \sqrt{p}R$ ,  $p \simeq 2^k$ ,  $R$   $CP_2$  length scale? This looks attractive but there seems to be a problem.  $p$ -Adic length scales come as powers of  $\sqrt{2}$  rather than 2 and the strongly favored values of  $k$  are primes and thus odd so that  $n = k/2$  would be half odd integer. This problem can be solved.

1. The observation that the distance traveled by a Brownian particle during time  $t$  satisfies  $r^2 = Dt$  suggests a solution to the problem.  $p$ -Adic thermodynamics applies because the partonic 3-surfaces  $X^2$  are as 2-D dynamical systems random apart from light-likeness of their orbit. For  $CP_2$  type vacuum extremals the situation reduces to that for a one-dimensional random light-like curve in  $M^4$ . The orbits of Brownian particle would now correspond to light-like geodesics  $\gamma_3$  at  $X^3$ . The projection of  $\gamma_3$  to a time=constant section  $X^2 \subset X^3$  would define the 2-D path  $\gamma_2$  of the Brownian particle. The  $M^4$  distance  $r$  between the end points of  $\gamma_2$  would be given  $r^2 = Dt$ . The favored values of  $t$  would correspond to  $T_n = 2^n T_0$  (the full light-like geodesic).  $p$ -Adic length scales would result as  $L^2(k) = DT(k) = D2^k T_0$  for  $D = R^2/T_0$ . Since only  $CP_2$  scale is available as a fundamental scale, one would have  $T_0 = R$  and  $D = R$  and  $L^2(k) = T(k)R$ .
2.  $p$ -Adic primes near powers of 2 would be in preferred position.  $p$ -Adic time scale would not relate to the  $p$ -adic length scale via  $T_p = L_p/c$  as assumed implicitly earlier but via  $T_p = L_p^2/R_0 = \sqrt{p}L_p$ , which corresponds to secondary  $p$ -adic length scale. For instance, in the case of electron with  $p = M_{127}$  one would have  $T_{127} = .1$  second which defines a fundamental biological rhythm. Neutrinos with mass around .1 eV would correspond to  $L(169) \simeq 5 \mu m$  (size of a small cell) and  $T(169) \simeq 1. \times 10^4$  years. A deep connection between elementary particle physics and biology becomes highly suggestive.
3. In the proposed picture the  $p$ -adic prime  $p \simeq 2^k$  would characterize the thermodynamics of the random motion of light-like geodesics of  $X^3$  so that  $p$ -adic prime  $p$  would indeed be an inherent property of  $X^3$ . For the weaker condition would be  $T_p = pT_0$ ,  $p$  prime,  $p \simeq 2^n$  could be seen as an outcome of some kind of "natural selection".
4. The fundamental role of 2-adicity suggests that the fundamental coupling constant evolution and  $p$ -adic mass calculations could be formulated also in terms of 2-adic thermodynamics. With a suitable definition of the canonical identification used to map 2-adic mass squared values to real numbers this is possible, and the differences between 2-adic and  $p$ -adic thermodynamics are extremely small for large values of for  $p \simeq 2^k$ . 2-adic temperature must be chosen to be  $T_2 = 1/k$  whereas  $p$ -adic temperature is  $T_p = 1$  for fermions. If the canonical identification is defined as

$$\sum_{n \geq 0} b_n 2^n \rightarrow \sum_{m \geq 1} 2^{-m+1} \sum_{(k-1)m \leq n < km} b_n 2^n ,$$

it maps all 2-adic integers  $n < 2^k$  to themselves and the predictions are essentially same as for  $p$ -adic thermodynamics. For large values of  $p \simeq 2^k$  2-adic real thermodynamics with  $T_R = 1/k$  gives essentially the same results as the 2-adic one in the lowest order so that the interpretation in terms of effective 2-adic/ $p$ -adic topology is possible.

### 6.3 Number theoretic criticality and $M$ -matrix

Number theoretic universality has been one of the basic guide lines in the construction of quantum TGD. There are two forms of the principle.

1. The strong form of number theoretical universality states that physics for any system should effectively reduce to a physics in algebraic extension of rational numbers at the level of  $M$ -matrix so that an interpretation in both real and  $p$ -adic sense (allowing a suitable algebraic extension of  $p$ -adics) is possible. One can however worry whether this principle only means that physics is algebraic so that there would be no need to talk about real and  $p$ -adic physics at the level of  $M$ -matrix elements. It is not possible to get rid of real and  $p$ -adic numbers at the level of classical physics since calculus is a prerequisite for the basic variational principles used to formulate the theory. For this option the possibility of completion is what poses conditions on  $M$ -matrix.
2. The weak form of principle requires only that both real and  $p$ -adic variants of physics make sense and that the intersection of these physics consist of physics associated with various algebraic extensions of rational numbers. In this rational physics would be like rational numbers allowing infinite number of algebraic extensions and real numbers and  $p$ -adic number fields as its completions. Real and  $p$ -adic physics would be completions of rational physics. In this framework criticality with respect to phase transitions changing number field becomes a viable concept. This form of principle allows also purely  $p$ -adic phenomena such as  $p$ -adic pseudo non-determinism assigned to imagination and cognition. Genuinely  $p$ -adic physics does not however allow definition of notions like conserved quantities since the notion of definite integral is lacking and only the purely local form of real physics allows  $p$ -adic counterpart.

Experience has taught that it is better to avoid too strong statements and perhaps the weak form of the principle is enough. It is however clear that number theoretical criticality could provide important insights to quantum TGD:  $p$ -adic thermodynamics is excellent example of this. In consciousness theory the transitions transforming intentions to actions and actions to cognitions would be key applications. Needless to say, zero energy ontology is absolutely essential: otherwise this kind of transitions would not make sense. The considerations in the sequel could be seen as being about conditions of number theoretical criticality if the weak form of principle is adopted.

#### 6.3.1 Number theoretic constraints on $M$ -matrix

Number theoretic constraints on  $M$ -matrix are non-trivial even for weaker notion of number theoretical universality.

##### Number theoretic criticality

Number theoretical criticality (or number theoretical universality in strong sense) requires that  $M$ -matrix elements are algebraic numbers. This is achieved naturally if the definition of  $M$ -matrix elements involves only the data associated with the number theoretic braid. Note that this data is non-local since it involves information about tangent space of  $X^4$  at the point so that discretization happens in geometric sense but not in information theoretic sense. Note also that for algebraic surfaces finite number of points of surface allows to deduce the parameters of the polynomials involved and thus to deduce the entire surface.

If quantum version of configuration space is adopted one must perform quantization for  $E^2 \subset M^4$  coordinates of points  $S_i^2$  braid and  $CP_2$  coordinates of  $M^2$  braid. In this kind of situation it becomes unclear whether one can speak about braiding anymore. This might make sense if each braid topology corresponds to its own quantization containing information about the fact that deformations of  $X_i^3$  respect the braiding topology.

The partonic vertices appearing in  $M$ -matrix elements should be expressible in terms of  $N$ -point functions of some rational super-conformal field theory but with the  $p$ -adically questionable  $N$ -fold integrals over string appearing in the definition of  $n$ -point functions. The most elegant manner to proceed is to replace them with their explicit expressions if they are algebraic functions- quite generally or in number theoretical criticality. Spin chain type string discretization is an alternative, not so elegant option.

Propagators, that is correlations between partonic 2-surfaces, would be due to the interior dynamics of space-time sheets which means a deviation from super string theory. Another function of interior degrees of freedom is to provide zero modes of metric of WCW identifiable as classical degrees of freedom of quantum measurement theory entangling with quantal degrees of freedom at partonic 3-surfaces.

Number theoretical criticality poses very strong conditions on the theory.

1. The p-adic variants of 4-D field equations associated with Kähler action make sense. Also the notion of preferred extremal makes sense in p-adic context if it corresponds to quantum criticality in the sense that second variation of Kähler action vanishes for dynamical symmetries. A natural further condition is that the surface is representable in terms of algebraic equations involving only rational or algebraic coefficients and thus making sense both in real and p-adic sense. In this case also Kähler action and classical charges could exist in some algebraic extension of p-adic numbers.
2. Also modified Dirac equation makes sense p-adically. The exponent of Kähler function defining vacuum functional is well-defined notion p-adically if the identification as product of finite number of eigenvalues of the modified Dirac operator is accepted and eigenvalues are algebraic. Also the notion of configuration space metric expressible in terms of derivatives of the eigenvalues with respect to complex coordinates of configuration space makes sense.
3. The functional integral over configuration space can be defined only as an algebraic extension of real functional integral around maximum of Kähler function if the theory is integrable and gives as a result an algebraic number. One might hope that algebraic p-adicization makes sense for the maxima of Kähler function. The basic requirement is that the inverse of the matrix defined by the Kähler metric defining propagator is algebraic function of the complex coordinate of configuration space. If the eigen-values of the modified Dirac operator satisfy this condition this is indeed the case.
4. Ordinary perturbation series based on Feynman diagrams makes sense also in p-adic sense since the presence of cutoff for the size of  $CD$  implies that the number of terms is finite. One must be however cautious with momentum integrations which should reduce to finite sum due to the presence of both IR and UV cutoff implied by the finite size of  $CD$ . The formulation in terms of number theoretic braids whose intersections with partonic 2-surfaces consist of finite number of points supports the possibility of number theoretic universality.

### The identification of number theoretic braids

To specify number theoretical criticality one must specify some physically preferred coordinates for  $M^4 \times CP_2$  or at least  $\delta M^4_{\pm} \times CP_2$ . Number theoretical criticality requires that braid belongs to the algebraic intersection of real and p-adic variants of the partonic 2-surface so that number theoretical criticality reduces to a finite number of conditions. This is however not strong enough condition and one must specify further physical conditions.

#### 1. What are the preferred coordinates for $H$ ?

What are the preferred coordinates of  $M^4$  and  $CP_2$  in which algebraicity of the points is required is not completely clear. The isometries of these spaces must be involved in the identification as well as the choice of quantization axes for given  $CD$ . In [?] I have discussed the natural preferred coordinates of  $M^4$  and  $CP_2$ .

1. For  $M^4$  linear  $M^4$  coordinates chosen in such manner that  $M^2 \times E^2$  decomposition fixing quantization axes is respected are very natural. This restricts the allowed Lorentz transformations to Lorentz boosts in  $M^2$  and rotations in  $E^2$  and the identification of  $M^2$  as hyper-complex plane fixes time coordinate uniquely.  $E^2$  coordinates are fixed apart from the action of  $SO(2)$  rotation. The rationalization of trigonometric functions of angle variables allows angles associated with Pythagorean triangles as number theoretically simplest ones.
2. The case of  $CP_2$  is not so easy. The most obvious guess in the case of  $CP_2$  the coordinates corresponds to complex coordinates of  $CP_2$  transforming linearly under  $U(2)$ . The condition

that color isospin rotations act as phase multiplications fixes the complex coordinates uniquely. Also the complex coordinates transforming linearly under  $SO(3)$  rotations are natural choice for  $S^2$  ( $r_M = \text{constant}$  sphere at  $\delta M_{\pm}^4$ ).

- Another manner to deal with  $CP_2$  is to apply number  $M^8 - H$  duality. In  $M^8$   $CP_2$  corresponds to  $E^4$  and the situation reduces to linear one and  $SO(4)$  isometries help to fix preferred coordinate axis by decomposing  $E^4$  as  $E^4 = E^2 \times E^2$ . Coordinates are fixed apart the action of the commuting  $SO(2)$  sub-groups acting in the planes  $E^2$ . It is not clear whether the images of algebraic points of  $E^4$  at space-time surface are mapped to algebraic points of  $CP_2$ .

### 2. The identification of number theoretic braids

It took some years to end up with a unique identification of number theoretic braids [K15, ?]. As a matter fact, there are several alternative identifications and it seems that all of them are needed. Consider first just braids without the attribute 'number theoretical'.

- Braids can be identified as lifts of the projections of  $X_i^3$  to the quantum critical sub-manifolds  $M^2$  or  $S_i^2$ ,  $i = I, II$ , and in the generic case consist of 1-dimensional strands in  $X_i^3$ . These sub-manifolds are obviously in the same role as the plane to which the braid is projected to obtain a braid diagram.
- Braid points are always quantum critical against the change of Planck constant so that TQFT like theory characterizes the freedom remaining intact at quantum criticality. Quantum criticality in this sense need not have anything to do with the quantum criticality in the sense that the second variation of Kähler action vanishes -at least for the variations representing dynamical symmetries in the sense that only the inner product  $\int (\partial L_D / \partial h_{\alpha}^k) \delta h^k d^4x$  ( $L_D$  denotes modified Dirac Lagrangian) without the vanishing of the integrand. This criticality leads to a generalization of the conceptual framework of Thom's catastrophe theory [K15].
- It is not clear whether these three braids form some kind of trinity so that one of them is enough to formulate the theory or whether all of them are needed. Note also that one has quantum superposition over  $CDs$  corresponding to different choices of  $M^2$  and the pair formed by  $S_I^2$  and  $S_{II}^2$  (note that the spheres are not independent if both appear). Quantum measurement however selects one of these choices since it defines the choice of quantization axes.
- One can consider also more general definition. The extrema of Kähler magnetic field strength  $\epsilon^{\alpha\beta} J_{\alpha\beta}$  at  $X^2$  define in natural manner a discrete set of points defining the nodes of symplectic triangulation. This set of extremals is same for all deformations of  $X_i^3$  allowed in the functional integral over symplectic group although the positions of points change. For preferred symplectically invariant light-like coordinate of  $X_i^3$  braid results. Also now geodesic spheres and  $M^2$  would define the counterpart of the plane to which the braids are projected.

Number theoretic braids would be braids which are number theoretically critical. This means that the points of braid in preferred coordinates are algebraic points so that they can be regarded as being shared by real partonic 2-surface and its p-adic counterpart obeying same algebraic equations. The phase transitions between number fields would mean leakage via these 2-surfaces playing the role of back of a book along which real and p-adic physics representing the pages of a book are glued together. The transformation of intention to action would represent basic example of this kind of leakage and number theoretic criticality could be decisive feature of living matter. For number theoretic braids at  $X_i^3$  whose real and p-adic variants obey same algebraic equations, only subset of algebraic points is common to real and p-adic pages of the book so that discretization of braid strand is unavoidable.

### 6.3.2 Physical representations of Galois groups

It would be highly desirable to have concrete physical realizations for the action of finite Galois groups. TGD indeed provides two kinds of realizations of this kind. For both options there are good hopes about the unification of number theoretical and geometric Galois programs obtained by replacing permutations with braiding homotopies and by a discretization of the continuous situation to a finite number theoretic braids having finite Galois groups as automorphisms.



### Number theoretical braids and the representations of finite Galois groups as outer automorphisms of braid group algebra

Number theoretical braids [?, K71] are in a central role in the formulation of quantum TGD based on general philosophical ideas which might apply to both physics and mathematical cognition and, one might hope, also to a good mathematics.

An attractive idea inspired by the notion of the number theoretical braid is that the symmetric group  $S_n$  might act on roots of a polynomial represented by the strands of braid and could thus be replaced by braid group  $B_n$ .

The basic philosophy underlying quantum TGD is the notion of finite resolution, both the finite resolution of quantum measurement and finite cognitive resolution [?]. The basic implication is discretization at space-time level and finite-dimensionality of all mathematical structures which can be represented in the physical world. At space-time level the discretization means that the data involved with the definition of  $M$ -matrix comes from a subset of a discrete set of points in the intersection of real and  $p$ -adic variants of partonic 2-surface obeying same algebraic equations. Note that a finite number of braids could be enough to code for the information needed to reconstruct the entire partonic 2-surface if it is given by polynomial or rational function having coefficients as algebraic numbers. Entire configuration space of 3-surfaces would be discretized in this picture. Also the reduction of the infinite braid to a finite one would conform with the spontaneous symmetry breaking  $S_\infty$  to diagonally imbedded finite Galois group imbedded diagonally.

#### 1. Two objections

Langlands correspondence assumes the existence of finite-dimensional representations of  $Gal(\overline{Q}/Q)$ . In the recent situation this encourages the idea that the restrictions of mathematical cognition allow to realize only the representations of  $Gal(\overline{Q}/Q)$  reducing in some sense to representations for finite Galois groups. There are two counter arguments against the idea.

1. It is good to start from a simple abelian situation. The abelianization of  $G(\overline{A}/Q)$  must give rise to multiplicative group of adèles defined as  $\hat{Z} = \prod_p Z_p^\times$  where  $Z_p^\times$  corresponds to the multiplicative group of invertible  $p$ -adic integers consisting of  $p$ -adic integers having  $p$ -adic norm equal to one. This group results as the inverse limit containing the information about subgroup inclusion hierarchies resulting as sequences  $Z^\times/(1+pZ)^\times \subset Z^\times/(1+p^2Z)^\times \subset \dots$  and expressed in terms factor groups of multiplicative group of invertible  $p$ -adic integers.  $Z_\infty/A_\infty$  must give the group  $\prod_p Z_p^\times$  as maximal abelian subgroup of Galois group. All smaller abelian subgroups of  $S_\infty$  would correspond to the products of subgroups of  $\hat{Z}^\times$  coming as  $Z_p^\times/(1+p^n Z)^\times$ . Representations of finite cyclic Galois groups would be obtained by representing trivially the product of a commutator group with a subgroup of  $\hat{Z}$ . Thus one would obtain finite subgroups of the maximal abelian Galois group at the level of representations as effective Galois groups. The representations would be of course one-dimensional.

One might hope that the representations of finite Galois groups could result by a reduction of the representations of  $S_\infty$  to  $G = S_\infty/H$  where  $H$  is normal subgroup of  $S_\infty$ . Schreier-Ulam theorem [?] however implies that the only normal subgroup of  $S_\infty$  is the alternating subgroup  $A_\infty$ . Since the braid group  $B_\infty$  as a special case reduces to  $S_\infty$  there is no hope of obtaining finite-dimensional representations except abelian ones.

2. The identification of  $Gal(\overline{Q}/Q) = S_\infty$  is not consistent with the finite-dimensionality in the case of complex representations. The irreducible unitary representations of  $S_n$  are in one-one correspondence with partitions of  $n$  objects. The direct numerical inspection based on the formula for the dimension of the irreducible representation of  $S_n$  in terms of Yang tableau [?] suggests that the partitions for which the number  $r$  of summands differs from  $r = 1$  or  $r = n$  (1-dimensional representations) quite generally have dimensions which are at least of order  $n$ . If  $d$ -dimensional representations corresponds to representations in  $GL(d, C)$ , this means that important representations correspond to dimensions  $d \rightarrow \infty$  for  $S_\infty$ .

Both these arguments would suggest that Langlands program is consistent with the identification  $Gal(\overline{F}, F) = S_\infty$  only if the representations of  $Gal(\overline{Q}, Q)$  reduce to those for finite Galois subgroups via some kind of symmetry breaking.

### 2. Diagonal imbedding of finite Galois group to $S_\infty$ as a solution of problems

The idea is to imbed the Galois group acting as inner automorphisms diagonally to the  $m$ -fold Cartesian power of  $S_n$  imbedded to  $S_\infty$ . The limit  $m \rightarrow \infty$  gives rise to outer automorphic action since the resulting group would not be contained in  $S_\infty$ . Physicist might prefer to speak about number theoretic symmetry breaking  $Gal(\overline{Q}/Q) \rightarrow G$  implying that the representations are irreducible only in finite Galois subgroups of  $Gal(\overline{Q}/Q)$ . The action of finite Galois group  $G$  is indeed analogous to that of global gauge transformation group which belongs to the completion of the group of local gauge transformations. Note that  $G$  is necessarily finite.

### Representation of finite Galois groups as outer automorphism groups of HFFs

Any finite group  $G$  has a representation as outer automorphisms of a hyper-finite factor of type  $II_1$  (briefly HFF in the sequel) and this automorphism defines sub-factor  $\mathcal{N} \subset \mathcal{M}$  with a finite value of index  $\mathcal{M} : \mathcal{N}$  [?]. Hence a promising idea is that finite Galois groups act as outer automorphisms of the associated hyper-finite factor of type  $II_1$ .

More precisely, sub-factors (containing Jones inclusions as a special case)  $\mathcal{N} \subset \mathcal{M}$  are characterized by finite groups  $G$  acting on elements of  $\mathcal{M}$  as outer automorphisms and leave the elements of  $\mathcal{N}$  invariant whereas finite Galois group associated with the field extension  $K/L$  act as automorphisms of  $K$  and leave elements of  $L$  invariant. For finite groups the action as outer automorphisms is unique apart from a conjugation in von Neumann algebra. Hence the natural idea is that the finite subgroups of  $Gal(\overline{Q}/Q)$  have outer automorphism action in group algebra of  $Gal(\overline{Q}/Q)$  and that the hierarchies of inclusions provide a representation for the hierarchies of algebraic extensions. Amusingly, the notion of Jones inclusion was originally inspired by the analogy with field extensions [?]!

It must be emphasized that the groups defining sub-factors can be extremely general and can represent much more than number theoretical information understood in the narrow sense of the word. Even if one requires that the inclusion is determined by outer automorphism action of group  $G$  uniquely, one finds that any amenable, in particular compact [?], group defines a unique sub-factor by outer action [?]. It seems that practically any group works if uniqueness condition is given up.

The TGD inspired physical interpretation is that compact groups would serve as effective gauge groups defining measurement resolution by determining the measured quantum numbers. Hence the physical states differing by the action of  $\mathcal{N}$  elements which are  $G$  singlets would not be indistinguishable from each other in the resolution used. The physical states would transform according to the finite-dimensional representations in the resolution defined by  $G$ .

The possibility of Lie groups as groups defining inclusions raises the question whether hyper-finite factors of type  $II_1$  could mimic any gauge theory and one might think of interpreting gauge groups as Galois groups of the algebraic structure of this kind of theories. Also Kac-Moody algebras emerge naturally in this framework as will be discussed, and could also have an interpretation as Galois algebras for number theoretical dynamical systems obeying dynamics dictated by conformal field theory. The infinite hierarchy of infinite rationals in turn suggests a hierarchy of groups  $S_\infty$  so that even algebraic variants of Lie groups could be interpreted as Galois groups. These arguments would suggest that HFFs might be kind of Universal Math Machines able to mimic any respectable mathematical structure.

### Lifting the action of Galois group to braid action in the case of number theoretic braids

The various definitions of braids were already discussed. At number theoretic quantum criticality the points of braids are obtained as solutions of polynomial equation and thus one can assign to them a Galois group permuting the points of the braid.

To make the notion of number theoretic braid more concrete, let us introduce complex coordinate  $w$  of  $\delta M_\pm^4$  (assignable to the geodesic sphere  $S^2$  and transforming by a phase rotation under  $SO(2)$ ), the standard radial light-like coordinate  $r$  of  $\delta M_\pm^4$ , and Eguchi-Hanson coordinates  $\xi^i$ ,  $i = 1, 2$  of  $CP_2$  and corresponding complex coordinate of the geodesic sphere  $S_i^2$  represented as  $\xi^1 = \xi^2$  resp.  $\xi^1 = \bar{\xi}^2$ .

Assume that partonic 2-surface is expressible as a solution of polynomial equations

$$P_1(r, w, \xi^1, \xi^2) , P_2(r, w, \xi^1, \xi^2) , P_3(r, w, \xi^1, \xi^2) = 0 , \quad (6.3.1)$$

where  $P_1$  and  $P_2$  are complex valued polynomials and  $P_3$  a real valued polynomial with coefficients which are rational numbers. The additional two conditions defining the points of number theoretic braid are  $w = 0$ ,  $\xi^1 = \xi^2$ , or  $\xi^1 = \bar{\xi}^2$  corresponding to 3 different number theoretic braids. Since the points of the intersection of braid with  $X^2$  satisfy algebraic equations, their solutions are algebraic numbers and number theoretic braid results.

The solutions of these equations correspond to simultaneous roots of four polynomials each characterized by its own Galois group and the points of the number theoretic braid thus provide a geometric representation for the product of these Galois groups. By the 2-dimensionality of the geodesic spheres, it is natural to consider the replacement of the permutations representing the action of Galois group with braid group action so that a projective representation of Galois group is obtained. The action of braid group elements on induced spinor fields can be non-trivial and would induce action on physical states.

An alternative representation is based on use of  $\xi^2$  or  $\xi^1$  as a coordinate for  $X^2$ . Assume that  $X^2$  can be represented locally as a graph of a map from  $S_i^2$  and use the notation  $\xi = \xi^1$  to avoid confusion

$$r = P_1(\xi) \ , \quad w = P_2(\xi) \ , \quad \xi^2 = P_3(\xi) \ , \tag{6.3.2}$$

The braid is defined by the additional equation  $\xi^1 = \xi^2$  or  $\xi^1 = \bar{\xi}^2$ . The resulting equations are very similar to that in previous case.

The conditions for extremum of  $\epsilon^{\alpha\beta} J_{\alpha\beta}$  in the case of  $CP_2$  Kähler form read as

$$\begin{aligned} \frac{\partial J_{\xi\bar{\xi}}}{\partial \xi} &= 0 \ , \\ \frac{\partial J_{\xi\bar{\xi}}}{\partial \bar{\xi}} &= 0 \ , \\ J_{\xi\bar{\xi}} &= 2J_{\xi^1\bar{\xi}^1} + J_{\xi^1\bar{\xi}^2} \frac{\partial P_3}{\partial \bar{\xi}} + J_{\xi^2\bar{\xi}^1} \frac{\partial P_3}{\partial \xi} + 2J_{\xi^2\bar{\xi}^2} \frac{\partial P_3}{\partial \bar{\xi}} \frac{\partial P_3}{\partial \xi} \ . \end{aligned} \tag{6.3.3}$$

Analogous equations are obtained for the induced Kähler form  $J(\delta M_{\pm}^4)$  of  $\delta M_{\pm}^4$  (or  $S^2$ ). These equations are algebraic equations since the expressions for the components of the Kähler form in the complex coordinates of  $CP_2$  and  $S^2$  are rational functions. Hence also the extrema of Kähler magnetic fields could define number theoretic braids. What would be nice that in this case the Galois group would correspond to Galois groups of the polynomials defined by the derivatives of  $J$  and would depend on  $X^2$  via  $P_3$ . For the option situation is more complex but it seems possible to speak about Galois groups also now.

Can one imagine a genuine physical representation of braid group analogous to that induced by the braiding defined by  $X_i^3$ ?

1. One such representation is obtained if the partonic 2-surfaces at the ends of  $X_i^3$  are identical so that the braiding induces a unique permutation of the points. This kind of assumption looks however artificial.
2. One can consider also braidings induced by the closed paths in the spaces labeling different choices  $M^2$  and  $S_i^2$ . In this case braid group action would permute the roots in the general case. For instance,  $2\pi$  rotations in Lorentz and color group rotating quantization axes could induce non-trivial braiding permutation of the roots. This kind of rotation for subsystem containing  $CD$  in question could induce this kind of braid group action.
3. Also the closed paths in the symplectic group of  $\delta M_{\pm}^4 \times CP_2$  would induce braiding actions and also braided Galois actions. This action is especially natural for the number theoretic braids defined by extreme of  $\epsilon^{\alpha\beta} J_{\alpha\beta}$  since functional integral reduces to integral over symplectic group leaving the number and values of extrema invariant but changing the positions and therefore inducing braiding. Also closed paths in the space of coefficients of polynomials define Galois actions but in this case the rotations in general affect induced Kähler form.

### Does DNA replication have counterpart at the level of fundamental physics?

The fundamental question is what happens in the vertices represented by the partonic 2-surface? The study of the 3-vertex forces to ask whether the incoming braid is replicated in a manner very much analogous to the replication of DNA. Could braid replication make it possible to make copies of classical representations of number theoretic information. Quantum representation of information by irreducible representations of Galois group would not be replicable since each incoming braid would correspond to its own irreducible representation and the choice of these representations would not be a fully deterministic process.

It seems however that this replication is too strong an assumption since the fermionic oscillator operators associated with positive energy strands need not anticommute with those associated with negative energy strands. Therefore the  $n$ -point function can be non-trivial even if the ends of strands do not meet each other. Symplectic QFT actually predicts that this is not the case. The braid structure would however mean that partons/elementary particles might be much more complex objects than they are thought to be.

In [K81] DNA has been proposed to act as a topological quantum computer using braids. Both time-like braidings (dance metaphor is good here) and their space-like counterparts induced by the braiding of threads connecting to each other braid strands (the analog is the situation in which the feet of dancers connected by threads) are involved and these braidings are dual. Similar duality - in fact first suggested by the model of DNA as topological quantum computer - holds true at the fundamental level since the stringy curves connecting braid strands and braids strands define dual braidings related in the same manner. This duality is analogous to the duality of string diagrams of hadronic string model.

Maybe even elementary particles could be seen as a kind of quantum computers and their "genome" would code at least the initial data for the topological quantum computation program. Information processing involves besides computation also copying of data and its transfer. Particle interaction vertices would realize the copying of data and particle exchanges its communication whereas quantum computation would be carried by parton with quantum program identified with its execution (light-like 3-surfaces can be regarded either as states or processes).

Rather amazing outcome of this line of thought was the discovery [K29, K44] that the states of dark nuclei in nuclear string model can be naturally associated to three kinds of groups with dimensions 64, 64, and 20: numbers of DNA codons, RNA codons, and aminoacids. Even more: there is natural realization of the analog of the genetic code with exactly the same numbers of DNAs coding for a given aminoacid as for the vertebrate genetic code. The assumptions of the model are very general which suggests that the genetic code might be realized at nuclear level and that biochemistry could provide only one particular representation of the code.

### Fusion rules number theoretically

The idea that partonic 2-surfaces decompose into regions, one for each number theoretic braid, and that the number theoretic braids define representations of Galois groups permuting the strands of the braid as automorphisms in HFFs of type  $II_1$  suggests a fresh approach to the understanding of vertices. Kind of fusion rules would certainly be in question and the interpretation as representations of Galois groups might allow to deduce information about the fusion rules using symmetry arguments.

The first thing to notice is that in the vertex the number theoretic braids coincide so that the Galois groups  $G$  associated with incoming and outgoing braids are identical. Only in the situation in which polynomial defining  $G$  becomes reducible it might occur that some of incoming lines corresponds to a group which is product of subgroups of  $G$  but this situation is not expected to be generic.

Suppose that the number theoretic braids define irreducible projective representations of the Galois group  $G$  associated with the braid in HFF of type  $II_1$  as outer automorphisms via diagonal imbedding of  $G$ . In vertex one expects that fusion rules for these representations mean extraction of singlet from the tensor product of these representations. This suggest a picture very similar to the fusion of representations of  $SU(2)_q$  in the fusion rules of WZW theory which also can be understood in terms of braiding. If one accepts generalized McKay correspondence suggested [?], then the fusion rules for Galois group could have representation in terms of fusion groups for Lie group associated with it by generalized McKay correspondence.

## 6.4 What can one say about the braiding part of $M$ -matrix?

$M$ -matrix should reduce to pure braiding matrix in  $CD$  resp.  $CP_2$  degrees of freedom at quantum criticality against change of Planck constant and this allows to say something non-trivial about this part of  $M$ -matrix.

### 6.4.1 Are factorizable QFT in $M^2$ and topological QFT in $S^2$ associated with quantum criticality?

Planck constant depends on the sector of the generalized imbedding space and is ill-defined for partonic 2-surfaces in quantum critical sub-manifolds  $M^2 \times^C P_2$  and  $M^4 \times S_i^2$ ,  $i = I, II$ . Maximal quantum criticality corresponds to  $M^2 \times S_i^2$ .  $S_I^2$  corresponds to vacuum extremal so that quantum critical partonic 2-surfaces represent vacuum extremals of Kähler action. It depends on assumptions that one is willing to make whether homologically non-trivial geodesic sphere  $S_{II}^2$  can be allowed and whether the pure gauge part of Kähler gauge potential can have  $M^4$  part [?].

The natural question is what happens at criticality. Is  $M$ -matrix completely trivial or do topological degrees of freedom remain. 2-D QFTs in  $M^2$  known as factorizing QFTs are almost trivial [?, ?], and generalize the topological QFTs associated with braids. Also topological QFTs at sphere with pictures - defined by braid points- are possible. The  $S$ -matrix of these theories does not depend on Planck constant [?, ?]. Hence it is quite possible that these theories describe the situation at quantum criticality.

As explained, number theoretical braids come in 3 variants corresponding to the projections of  $X_I^3$  to  $M^2$ ,  $S_I^2$ , and  $S_{II}^2$  carrying the analogs of braid diagram obtained as a projection of braid to plane so that braid points are always quantum critical. It is not clear whether these alternatives provide trinity of descriptions or whether all of them are needed. The dynamics in  $M^4$  resp.  $CP_2$  degrees of freedom should reduce to this kind of QFT in  $M^2$  resp.  $S_I^2$  and to both for  $M^2 \times S_I^2$ .

This would mean in particular, that the  $S$ -matrix -or more generally  $M$ -matrix- does not depend on the value of  $\hbar$ . Since partons are 2-dimensional, one would have for  $M^2 \times S_i^2$  essentially light-like geodesics as allowed solutions of field equations and thus classical theory of free massless particles. Hence factorizing QFT would be a natural description for the quantum critical dynamics at quantum criticality. This  $M$ -matrix should appear also in the full  $M$ -matrix as a factor.

### 6.4.2 Factorizing 2-D $S$ -matrices and scattering at quantum criticality

In this subsection the view that the scattering in imbedding space degrees of freedom at quantum criticality could be described using a tensor product of 2-D factorizing  $S$ -matrices associated with the plane  $M^2$  and geodesic spheres  $S_i^2$  of  $CP_2$  defining quantization axes for a given  $CD$  and serving as critical manifolds for the phase transitions changing Planck constant realized as a leakage between different pages of  $CD$  and/or  $CP_2$  book.

#### Factorizing $S$ -matrix in $M^2$ as a building block of the full $U$ -matrix

##### 1. Why factorizability?

The known exact  $S$ -matrices in 1+1-dimensional space time are factorizing. According to [?] there exists a strong evidence that all exact  $S$ -matrices in 1+1 dimensions are factorizing, do not allow particle production, and that the sets of the initial and final state momenta are identical.

Exactness certainly follows from infinite number of conservation laws associated with integrable systems but also finite number of them is enough. Infinite number of conservation laws are expected also in TGD since Kac Moody type symmetries are present. The conserved charges of form

$$Q_a^n = \exp(n\theta_i) Q_a \quad , \quad (6.4.1)$$

where  $n$  is Lorentz spin completely analogous to conformal weight imply the factorizability [?]. These charges have interpretation as loop group generators of conformal weight  $n$  in the defining representation (where these generators are proportional to  $m^n$ ) evaluated at the ray  $\eta_i$  of  $M^2$  representing

momenta as the positions for tips of light-cones. In the case of  $E^2$  one obtains  $\exp(i\phi_n)$  where  $\phi_n$  represent directions of momenta classically.

### 2. Yang-Baxter equations and Zamolodchikov algebra

Arranging the scattering particles in  $M^2$  with respect to rapidities  $\eta_i$  (hyperbolic angles) such that the fastest particle is leftmost and slowest one rightmost (this is possible by the crossing symmetry and by assuming Yang-Baxter equations), the scattering can be described as a sequence of events in which particles pass by each other and can be therefore interpreted as a braiding like process with the additional feature that particles move with different velocities.

The pass-by event is described by a 2-particle  $S$ -matrix depending only on the difference  $\eta_{12} = \eta_1 - \eta_2$  of their rapidities. By Uncertainty Principle, the position of the particle world line should not matter so that the world line of any particle can be shifted parallel to itself without affecting the  $S$ -matrix. This however affects the braiding. This symmetry gives rise to the celebrated Yang-Baxter equations

$$S(\eta_{12})S(\eta_{13})S(\eta_{23}) = S(\eta_{23})S(\eta_{13})S(\eta_{12}) . \quad (6.4.2)$$

$N$ -particle  $S$ -matrix reduces to braiding  $S$ -matrix expressible in terms of  $S$ -matrices describing 2-particle scattering.

One can abstract the conditions on  $S$ -matrix algebraically to give what is known as Zamolodchikov algebra [?] so that  $S$ -matrix describes the pass-by process as a generalization of the exchange operation in braiding. Posing the conditions that 2-particle  $S$ -matrix approaches unit matrix at the limit  $\eta_{12} \rightarrow 0$ , unitarity stating  $S(\eta)S(-\eta) = 1$ , real analyticity  $S^\dagger(\eta) = S(-\bar{\eta})$  and crossing symmetry  $S_{ij}^{kl}(\eta) = S_{jl}^{ik}(i\pi - \eta)$ , one achieves axiomatization for the algebra. Sine-Gordon theory provides a basic example of an integrable system whose  $S$ -matrix satisfying these constraints.

If one poses the restriction that light cone tips belong to  $M^1$  situation simplifies still since all particles defined by the contents of light cones would be at rest relative to each other and the  $S$ -matrix reduces to a trivial braiding matrix obtained by putting  $\eta_{ij} = 0$  in above equation. The limit  $\eta_{ij} \rightarrow \pm\infty$  when taken in a somewhat delicate manner gives rise to the standard form of the non-unitary braiding matrix appearing in quantum group representations as shown by Jimbo [?].

### 3. Could factorizing $S$ -matrix as tensor factor of full $S$ -matrix make sense in TGD framework?

In a genuinely 2-D context this kind of system is of course physically somewhat uninteresting. In TGD framework the situation is different if factorizing  $S$ -matrices are interpreted as describing scattering at criticality with respect to phase transitions changing Planck constant and assignable to time like braiding since  $M^2$  is analogous to the plane to which braid strands are projected. The basic condition is that the  $S$ -matrix elements have not dependence on Planck constant and this condition is indeed satisfied. The most general manner to satisfy this condition is by the vanishing of loop corrections to the scattering amplitudes so that only tree diagrams contribute.

By quantum classical correspondence the rapidities could be interpreted as  $M^2$  projections of the 4-momenta of the particles created in the vertex. Since each light-cone can contain arbitrary many partons, the rapidities could be interpreted as  $M^2$  projections of four-momenta assignable to braid strands.

The scattering matrix associated with time-like braiding would thus be almost trivial in longitudinal momentum projections but would not depend on the transversal momenta at all. The integration over all possible choices of  $M^2$  plane would guarantee Lorentz invariance might destroy unitarity. Also the triviality in longitudinal momentum degrees for freedom looks non-physical.

### Factorization of $S$ -matrix in $CP_2$ degrees of freedom

The backs of  $CP_2$  book correspond to the geodesic spheres  $S_i^2$  so that at quantum criticality one has braiding with braid projection to  $S_i^2$ ,  $i = I$  or  $i = II$ .

Center of mass degrees of freedom are unavoidable also in  $CP_2$  degrees of freedom since Jones inclusions defined by the subgroups  $G \subset SU(2) \subset SU(3)$  select preferred origin with respect to which  $U(2)$  sub-group defining quantization axis acts linearly so that the choice of quantization axes means also a choice of preferred point of  $CP_2$ .

One can ask whether the complex  $CP_2$  coordinates should be replaced with a quaternionic coordinate in such manner that the restriction to a geodesic sphere  $S_i^2$  of  $CP_2$ ,  $i = I, II$  or both would be the Euclidian analog of the restriction to  $M^2$  meaning restriction to scattering in compactified complex plane and commutativity of generalized  $n$ -point functions. This was the question that I posed for years ago and the quantization of Planck constants gives an affirmative answer to this question but from quite different philosophy.

Finite measurement resolution implies the replacement of the configuration space Clifford algebra with its finite-quantum-dimensional variant. Same applies to configuration space itself and one should understand what this means.

1. There seems to be no need for making configuration space coordinates non-commutative. Rather, configuration space would be reduced to effectively finite-dimensional space obtained by replacing 2-surfaces with intersections of number theoretic braids with  $X^2$ . This would mean that the configuration space Hamiltonians - representable as integrals involving the Hamiltonians of  $\delta M_{\pm}^4 \times CP_2$  and representing coordinates of configuration space - are replaced with expressions involving sums over points of the braid instead of integrals [K15].
2. Quantum groups should thus emerge via braidings. The observation that  $CP_2$  parameterizes braiding matrices and that  $S^2$  commutative braiding matrices - to be discussed below- might mean that  $CP_2$  points represented as braiding matrices become non-commutative and that this forces the restriction of  $M^4$  and  $CP_2$  projections to geodesic spheres. This non-commutativity is of course something quite different from the non-commutativity in the sense of quantum groups.
3. This non-commutativity could reflect itself in the braiding of number theoretic braids. In the case of  $M^2$  braids the braiding tensor product of the matrices parameterized by the points of  $S^2 \subset \delta M_{\pm}^4$  and  $CP_2$ ,  $i = I$  or  $II$ , could define the braiding as a local operation. In the case of  $S_i^2$  braid the braiding matrix could be the tensor product of braiding matrices parameterized by the point of  $S_{i+1}^2$  and  $M^4$  point, presumably through its  $S^2$  coordinates only. For  $M^2$  braids the appearance of  $CP_2$  braiding matrices would mean that the over-all braiding matrix obtained as a product of elementary braiding matrices depends on their order. In the case of Quantum Hall effect this means that non-Abelian anyons would be in question.

That this can be done is also suggested by an intriguing observations. The observation that for six-vertex model the solutions of Yang-Baxter equation are parameterized by  $CP_2$  [?] was one of the first intriguing observations [K81] leading to the evolution of ideas the role of quantum groups and von Neumann algebras in TGD.

#### 1. $CP_2$ parameterizes $R$ -matrices

In six-vertex model the  $R$ -matrices (counterparts of  $S$ -matrices above) have slightly different form than the  $S$ -matrices. For weak (or color) isospin 1/2 case which is fundamental also now,  $R$ -matrix is parameterized by 3 complex parameters

$$R(a, b, c) = \begin{pmatrix} a & & & & \\ & b & c & & \\ & c & b & & \\ & & & & a \end{pmatrix}. \quad (6.4.3)$$

The matrices differing by a complex scaling are physically equivalent so that  $a, b$  and  $c$  can be interpreted as complex components of fundamental representation of  $SU(3)$ .  $c$  can be fixed to  $c = isin(\gamma)$ , where  $exp(i\gamma)$  can in fact be identified as the quantum phase  $q = exp(i\pi/n)$  and  $a$  and  $b$  can be identified as complex  $CP_2$  coordinates  $(\xi^2, \xi^2)$  transforming linearly under  $U(2) \subset SU(3)$ .

The restriction of  $a$  and  $b$  to represent points of a geodesic sphere of  $CP_2$  going through origin implies that the matrices  $R(a, b, c)$  commute. The condition for commutativity reads as

$$\begin{aligned} \Delta(a, b, c) &= \Delta(a', b', c') , \\ \Delta &= \frac{a^2 + b^2 - c^2}{2ab} . \end{aligned} \quad (6.4.4)$$

The solution of Yang-Baxter equation for three R-matrices reduces to the condition

$$\Delta(a, b, c) = \Delta(a', b', c') = \Delta(a'', b'', c'') . \quad (6.4.5)$$

Commutativity (in the sense of  $S$ -matrices rather than with respect to the product appearing in Yang-Baxter equations) means that the three points of  $CP_2$  belong to the geodesic sphere identifiable also as a maximal commuting sub-manifold of  $CP_2$  interpreted as a space obtained by gluing together three copies of quaternionic space  $H$  along sphere  $S^2$  representing compactified complex plane for the second quaternionic space glued together just like  $S^2$  is obtained by gluing together two complex planes along real line compactified to circle.

A canonical parametrization satisfying the commutativity conditions is given by

$$\begin{aligned} a(u) &= \sinh(u + i\gamma) , \\ b(u) &= \sinh(u) , \\ c(u) &= i\sin(\gamma) , \end{aligned} \quad (6.4.6)$$

where  $u$  is a complex coordinate. Using  $u$  as coordinate the Yang-Baxter equations have the same additive form as in case of  $M^4$ . In other words, one has  $u'' = u' - u$ . Unitarity is achieved when  $u$  is real.

These observations made already earlier [K81] suggest that the construction for  $M^2$  generalizes to  $CP_2$  degrees of freedom representing its Euclidian version obtained by the replacement  $M^2 \subset M^4 \rightarrow S_i^2 \subset CP_2$ . The commutativity of R-matrices in the case of  $S^2$  would have interpretation in terms of space-like metric whereas in the case of  $M^4$  Minkowski signature implies correlations and non-commutativity.

The commutativity of R-matrices at the geodesic sphere is an intriguing result. The notion of finite measurement resolution suggests that configuration space Clifford algebra and configuration space itself must be replaced by their finite-quantum-dimensional quantum variants. For configuration space Hamiltonians this might mean the replacement of  $CP_2$  coordinates with their quantum counterparts. Could one imagine that R-matrices labeled by  $CP_2$  points could serve as quantum representatives of  $CP_2$  points and commutativity condition forces the restriction  $CP_2$  projection to the braid points to  $S_i^2$ ?

## 2. Factorizing $S$ -matrix associated with a geodesic sphere of $CP_2$

Quantum classical correspondence can be applied also now as a guide line. Before continuing it is however useful to restate some facts about  $CP_2$  and introduce notations. Assume for definiteness that  $CP_2$  is identified as the space of right cosets  $gU(2)$  of  $SU(3)$  so that the natural action of  $SU(3)$  is left action. The orbits of  $SU(2)_L$  and  $U(2)_L$  are homologically non-trivial geodesic spheres  $S^2$  and the double coset space  $SU(3)/SU(2)_L \times SU(2)_R$  of these spheres is 2-dimensional.

Also the geodesic circles  $S^1_\perp$  orthogonal to a given point of  $S^2$  are interesting as analogs of  $M^1$  in  $M^1 \times S^2$  decomposition. By the symmetry of  $SU(3)/SU(2)_L \times SU(2)_R$  the actions of both  $SU(3)_L$  and  $SU(3)_R$  in this space are well defined, and the natural idea is that  $U(1)_R$  action defines the geodesic circles  $S^1_\perp$  so that electro-weak symmetry group would have a geometric counterpart.

Both  $SU(2)_L \subset SU(3)$  and weak  $SU(2)_L$  are represented by  $4 \times 4$ -dimensional  $R$ -matrices acting on fundamental fermions. The coordinate  $u$  parameterizing commuting R-matrices corresponds to the geodesic sphere  $S^2 \subset CP_2$ .

1.  $SU(2)_L \subset SU(3)$  quantum numbers replace  $M^2$  momentum. Indeed, color is in TGD framework not a spin like quantum number but completely analogous to four-momentum and orbital angular momentum.
2. The complex coordinates  $\xi^i$ ,  $i = 1, 2$ , of  $CP_2$  have a phase  $\exp[i(\pm\phi + \psi)/2]$  with  $\phi$  assignable to isospin and  $\psi$  to hypercharge.  $\xi^2 = 0$  geodesic sphere thus represents  $I_3 + Y$  rotation. The classical representation for the quantization of angular momentum suggests that the direction of the total  $I_3 + Y$  associated with a particular  $\delta M^4_\perp \times CP_2$  defines a point at  $S^2$  parameterized in standard manner by  $(\theta, \phi)$ . This fixes the value of  $\theta$  via the condition



$$\cos(\theta) = \frac{I_3 + Y}{\sqrt{I(I+1) + Y^2}} \quad (6.4.7)$$

when  $\xi^2 = 0$  is selected as the representative geodesic sphere.

3. The angle  $\phi$  is the Euclidian counterpart of rapidity  $\eta$  so that that the classical model for the scattering would be in terms of particles rotating with different velocities along the circumference of circle. The momenta would be replaced with isospins  $(I^3 + Y)_k$  ordered from left to right along the circumference such that one has  $(I^3 + Y)_1 \geq (I^3 + Y)_2 \dots \geq (I^3 + Y)_n$  having  $\phi_1 \leq \phi_2 \dots \leq \phi_n$ . Unitarity requires that the parameter  $u$  is real and  $\gamma_i = \phi$  identification is suggestive.
  - (a) In the case of  $M^2$  the values of rapidities can be fixed by four-momenta but in the recent case there are no four-momenta and Uncertainty Principle does not encourage the fixing of the phases so that one must simply integrate over all possible values. Most naturally the convolution of the scattering amplitude with color partial waves for center of mass degrees of freedom defines this integration naturally.
  - (b) On the other hand, the existence of phases in algebraic extension of p-adic numbers would suggest that  $\phi_i$  can come only as multiples of the angle  $\pi/n$  defining the quantum phase  $q$  so that circle would be discretized to a circular lattice. The values of color isospin  $J$  would be restricted to  $J \leq n/2$  for even  $n$  since for  $J$  and  $J + n$  the wave functions differ only by a sign. For odd  $n$  one has  $J \leq n$ . This conforms with the fact that for the finite-dimensional representations of quantum groups associated with  $q = \exp(i\pi/n)$  the action of raising and lowering operators  $J_{\pm}^n$  reduces to a multiplication by a complex number [?], which can also vanish so that cyclic or semicyclic representations besides counterparts of ordinary finite-dimensional representations are obtained. Also the possibility of only  $j \leq n/2$  representations of Kac Moody group fits with this picture. The groups  $G \subset SU(2)$  for which  $n$  is the order of the maximal cyclic subgroup would naturally define as their orbits discrete analogs of the geodesic sphere allowing p-adicization and discrete versions of spherical harmonics. Physically the appearance of finite subgroups of  $SU(2)$  would be a direct analog for the presence of discrete subgroups of translation groups in solid state physics.
4. This construction would allow to fix the dependence of  $S$ -matrix on the center of mass coordinates and on total color quantum numbers and the integration over the orbifold  $SU(3)/SU(2)_L \times SU(2)_R$  of geodesic spheres of  $CP_2$  would restore the exact color invariance broken by Jones inclusion.
5. Just as the  $M^4$  coordinates of the arguments of n-point function can be restricted to  $M^1$ , their  $CP_2$  coordinates can be restricted to geodesic circle  $S^1 \subset S^2 \subset CP_2$  implying the reduction of  $S$ -matrix to braiding  $S$ -matrix.

#### What about Yang-Baxter type scattering in transversal degrees of freedom?

One could also consider construction of a Yang-Baxter type scattering matrix in transversal degrees of freedom. This  $S$ -matrix cannot give rise to momentum transfers. One could argue that this is not in spirit with the basic number theoretic idea. One could however modify the idea.  $E^2$  as the complement of hyper-complex plane in hyper-quaternionic space ( $z = xiJ + yiK$ ) can be mapped to complex plane by  $z \rightarrow iJz = x + yI$  and one can construct  $S$ -matrix for scattering in this plane. Similar argument applies in  $CP_2$  degrees of freedom.

##### 1. Factorizable $S$ -matrix $E^2$ degrees of freedom

It is straightforward to modify the construction for  $CP_2$  to construct  $S$ -matrix in transversal degrees of freedom. The angles  $\phi_i$  characterizing the directions of transversal momenta would replace rapidities and particles could be ordered with respect to these angles and the intersections of projections of orbits to  $E^2$  would define the interaction vertices. The commuting  $S$ -matrices applied in

case of  $CP_2$  parameterized by the values of  $u$  and  $\gamma$  could be used to define  $S$ -matrix. The values of  $\phi$  coming as multiples of quantum angle  $\pi/n$  suggest themselves in p-adic context as intersections of p-adic  $E^2$  with real one.

### 2. Factorizable $S$ -matrix in $S^1 \perp S^2$ degrees of freedom

If one allows pass-by events in  $E^2$ , one must allow them also for the counterpart of  $E^2$  in  $CP_2$ . Only the geodesic sub-manifolds representing commuting sub-algebra of quaternions and orbit of subgroup of color group are possible. This leaves only geodesic circles of  $CP_2$  orthogonal to geodesic sphere  $S^2$  into consideration. The reduction would be completely analogous to  $M^1 \times S^2$  decomposition in the case of  $M^4$ . As noticed, the action of  $U(1)_R$  groups in the space of geodesic spheres is well defined and generates these geodesic circles. The reduction of  $SU(2)_L \times SU(2)_R \subset SU(3)$  to  $SU(2)_L \times U(1)_R$  obviously correlates with the structure of the electro-weak gauge group.

The four-fold decomposition of  $H$  is analogous to the decomposition of 8-D spinors to four-fold tensor product of 2-D spinors.  $M^2$  ( $E^2$ ) represents classically hyperbolic (ordinary) rotations.  $\xi^2 = 0$  geodesic sphere  $S^2$  represents  $I_3 + Y$  rotations and  $S^1_\perp$  represents  $I_3 - Y$  rotations. Every commuting isometry charge of  $SO(3, 1) \times SU(3)$  would thus correspond to its own tensor factor in the factorizing  $S$ -matrix.

### Factorization for Kac-Moody representations

An interesting question relates to whether one should use finite-dimensional or infinite-dimensional representations of quantum Kac-Moody algebra to construct  $S$ -matrix as braiding matrix in Kac-Moody algebra. In both cases the counterpart of complex coordinate  $z$  restricted to unit circle (hyper-quaternionic  $M^2$  coordinate restricted to  $m \cdot m = 1$  hyperboloid) brings in angle (rapidity) variable.

1. Finite-dimensional representations are obtained from those of quantum group and have vanishing central charge  $k = 0$  and appear naturally in integrable 1+1-dimensional quantum theories so that the Yang-Baxter matrices are finite-dimensional, typically  $2 \times 2$  matrices acting on quantum spinors. The infinite number of conservation laws have a natural interpretation in terms of elements of this algebra. Since Lorentz invariance in longitudinal degrees of freedom should not be broken by the central extension, one might argue that finite-dimensional representations are natural in this case. Also the idea that Connes tensor product makes the situation finite-dimensional fits with this interpretation. On the other hand, the breaking of Lorentz invariance might be a property of zero energy states and reflect the measurement situation as will be found and one must be cautious here.
2. The braiding matrix for infinite-dimensional Kac-Moody representations was found by Drinfeld [?] and has exponential form bringing in mind an exponent of Hamiltonian. The representation involves also Virasoro generator  $L_0$ . Presumably the generalization to the case of super Kac-Moody algebras exist. Neither the Kac-Moody- or quantum group  $R$ -matrix is unitary. I do not know whether a unitary  $R$ -matrix for Kac-Moody algebras is excluded by some deep reason.

The following arguments support the view that only finite-dimensional representations appear in  $S$ -matrices between zero energy states which seem to be the only possibility in TGD framework.

1. The universality of the  $R$ -matrix for affine algebras encourages the guess non-unitarity is a universal property of Kac-Moody  $R$ -matrices containing only single continuous parameter and that unitary and thus trivial  $R$ -matrix is possible only in  $q = 1$  case. This would conform with the fact that  $q = 1$  also corresponds to extended ADE diagrams for Jones inclusions assignable to Kac-Moody representations.

Notice however that the non-unitary braiding  $R$ -matrix

$$\begin{pmatrix} q & & & \\ & 1 & q - q^{-1} & \\ & & 1 & \\ & & & q \end{pmatrix}$$

follows by a delicate limiting process from a unitary factorizing  $S$ -matrix at the limit  $\eta_{12} \rightarrow \pm\infty$  as shown by Jimbo [?]. Could the Kac-Moody  $R$ -matrix follow by a limiting procedure from a unitary  $R$ -matrix by allowing an additional continuous parameter analogous to rapidity to approach some limit?

2. The invariance under isometries requires that central extension must vanish in center of mass degrees of freedom so that only finite-dimensional representations are possible.
3. Only a finite number of degrees of freedom are observable in the sense that they appear in the  $S$ -matrix between zero energy states and this requires  $\mathcal{M} \rightarrow \mathcal{M}/\mathcal{N}$  reduction for Kac-Moody algebra leading to finite-dimensional Kac-Moody/quantum group representations.

### What the reduction to braid group representations means physically?

One could choose also  $M^1 \times S^2$  decomposition instead of  $M^2 \times E^2$ .  $M^1 \times S^2$  option gives ordinary braid group representations as the limit  $\eta_{ij} = 0$  meaning that the tips of light cones are at rest relative to each other. There is no convincing argument forbidding the braid group representations and they would be absolutely essential for topological quantum computation utilizing braiding  $S$ -matrices [K81].

For  $CP_2$  the two options correspond to  $(S^1, S^2)$  and  $(S^2, S^1)$  decompositions and are equivalent and  $SU(2)_L \times U(1)_R \subset SU(3)_L \times SU(3)_R$  reduction. A reduction to braid group representation occurs always in  $U(1)_R$  factor and is accompanied by a similar reduction in electro-weak degrees of freedom.

The geodesic circle  $S^1 \subset S^2$  with  $\theta = \pi/2$  implies  $(I_3 + Y)/\sqrt{I(I+1) + Y^2} = 0$  meaning the absence of  $I_3 + Y$  color rotation. The second color quantum number  $I_3 - Y$  is represented by a geodesic circle  $S^1_\perp$  orthogonal to  $S^2$  and should vanish by the same argument. Quantum classical correspondence predicts that physical states correspond to  $(I_3, Y) = (0, 0)$  states of color multiplets: the interpretation is as a weak form of color confinement. The vanishing of  $I_3$  and  $Y$  implied by the weak form of color confinement means a reduction to  $U(1)_L \times U(1)_R \subset SU(3)_L \times SU(3)_R$  so that  $S$ -matrix reduces to a braiding  $S$ -matrix in both  $S^1_\perp$  and  $S^2$  factors and also for electro-weak sector.

### The relationship with Jones inclusions

The factorization of  $S$ -matrix to four factorizing tensor factors suggest similar structure for Jones inclusions.

#### 1. The four basic types of Jones inclusions

Four kinds of Jones inclusions can be assigned with the pairs  $(M^2, E^2)$  and  $(S^2, S^1)$ . Same applies in case of  $(M^1, S^2)$  and  $(S^1, S^1)$  in TGD framework.

1. In  $M^2 \times E^2$  case the discrete subgroups of  $O(1, 1)$  and  $O(2)$  would characterize Jones inclusions. For  $E^2$  only  $G = A_n$  or  $D_{2n}$  are possible. For  $M^2$  the subgroups generated by powers of Lorentz boost and reflection are possible. The infinite order for these groups strongly suggests  $\beta = 4$ . The quantum phase  $q = \exp(i\pi/n)$  would emerge naturally if the action of Lorentz boosts on configuration space spinor fields is unitary and reduces to a cyclic action represented by  $A_{n-1}$ . This would be very much analogous to the reduction of the quantum group representations to finite-dimensional ones as  $q$  becomes a root of unity.
2.  $M^1 \times S^2$  option allows also  $G = E_6, E_8$  (tetrahedral and icosahedral groups) and  $SU(2)$ .
3. For  $CP_2$  all groups  $G \subset SU(2)_L$  and  $A_n \subset U(1)_R$  could define Jones inclusions. For color confined states only  $G_L = A_{n_L}$  and  $G_R = A_{n_R}$  are possible.

#### 2. The type of braiding correlates with the type of Jones inclusion

Jones inclusions come in two very different types corresponding to  $\beta < 4$  defined by the subgroups  $G \subset SU(2)$  and  $\beta = 4$  defined by  $G = SU(2)$  or infinite subgroups of  $SU(2)$ . The two kinds of  $S$ -matrices could correspond to the two types of Jones inclusions as following arguments suggest.

1. Constant Yang-Baxter matrices defining braid group representations emerge as intertwiners of quantum versions of Lie algebras whereas more general Yang-Baxter matrices emerge as intertwiners for the representations of quantum versions of Kac Moody algebras [?]. Thus  $M^2$  resp.  $S^2$  would correspond to a representation of quantum Kac-Moody algebra whereas  $M^1$  resp.  $S^1$  would represent a degeneration to a purely topological braid group representation in the case of  $SU(2)$ .
2. According to the arguments of [K25]  $\beta < 4$  corresponds to quantum group representations characterized by finite sub-groups  $G \subset SU(2)$  whereas  $\beta = 4$  representations corresponds to Kac Moody representations with monodromies of n-point functions characterized by the quantum phase  $q$ . It would seem that an equivalent characterization is as representations of quantum Kac Moody algebras.

### 3. Consistency with the TGD based explanation for McKay correspondence

These observations relate also interestingly to the proposal that TGD physics is universal in the sense of being able to mimic almost any physics obeying Kac Moody symmetry [K25].

1. McKay correspondence states that the finite subgroups  $G \subset SU(2)$  characterizing  $\beta < 4$  inclusions are labeled by ADE diagrams ( $A_n, D_{2n}, E_6$  and  $E_8$  are allowed). A concrete proposal was made for constructing the representations of the corresponding Kac-Moody algebras from these data by utilizing the new discrete degrees of freedom implied by the fact that space-time sheets define  $n(G)$ -fold coverings of  $M^4$  (of  $CP_2$  for  $SU(2) \subset SL(2, C)$ ). The group algebra of  $G$  associated with multiple coverings of  $M^4$  or  $CP_2$  gave the multiplets.

The degeneration of the  $S$ -matrix to braiding  $S$ -matrix does not kill this conjecture. The point is that  $n \geq 3$  condition for quantum phase excludes the Jones inclusion corresponding to  $A_2$  (two-element subgroup of  $SU(2)$ ). It would be just the representation of  $SU(2)$  realized in terms of quantum spinors which would degenerate to the braid group representation whereas other representations for which spin like degrees of freedom are represented in terms of group algebra of  $G$  are not lost.

2. For  $\beta = 4$  one obtains all extended ADE diagrams as characterizers of Jones inclusions, and an analogous construction of corresponding Kac Moody representations was proposed with quantum phase assigned with a non-trivial monodromy for n-point functions in  $S^2/G$ ,  $S^2$  a non-trivial geodesic sphere of  $CP_2$ . The natural identification would be as representations of quantum Kac-Moody algebra. All extended ADE diagrams are allowed which conforms with the fact that now  $SU(2)$  can be realized using quantum spinors. The representations of  $D_{2n+1}$  and  $E_7$  should involve both quantum spinors and the  $n(G)$ -fold covering of  $S^2/G$  defining the monodromy.
3. These proposals do not seem so speculative when one realizes that the finite dimensional representations of quantum groups can be regarded also as representations of quantum Kac-Moody algebras [?]. As found, the generators in defining representations appear also as conserved charges in the quantum field theory models giving rise to factorizing  $S$ -matrices.
4. According to the construction for  $\beta < 4$  the dimension of  $CP_2$  projection of the partonic 2-surface can be smaller than two: this excludes homological non-triviality. For  $\beta = 4$   $CP_2$  projection would be homologically non-trivial geodesic sphere. This is in harmony with the assumption that geodesic circle  $S^1$  and homologically non-trivial geodesic sphere  $S^2$  characterize the sub-manifold of  $CP_2$  to which the arguments of n-point functions belong for these representations.

### 6.4.3 Are unitarity and Lorentz invariance consistent for the quantum critical $M$ -matrix constructed from factorizing $S$ -matrices?

Factorizable  $M^2$   $S$ -matrices do not allow particle creation and the sets of initial and final state momenta are identical. The possibility to exchange internal quantum numbers possible in equal mass case could make possible momentum exchange in a very limited sense.

The extension to TGD framework brings in additional problems since the decomposition  $M^4 = M^2 \times E^2$  breaks manifest Lorentz invariance. Also color invariance is broken. The question is how to

achieve unitarity and Lorentz invariance simultaneously. The loss of these symmetries in case of  $U$ -matrix which characterizes universe rather than quantum state would be a catastrophe. This problem can be however circumvented.

$U$ -matrix constructible using the proposed decomposition  $M^2, E^2, S^2, S_{\perp}^1$  or its variant  $(M^1, S^2), (S^1, S_{\perp}^1)$  should be unitary. Unitarity is trivial to achieve if one just restricts to a given decomposition. Since Jones inclusions have a concrete effect on imbedding space geometry and topology, one could argue that this decomposition indeed reduces Lorentz symmetry to  $SO(1,1) \times SO(2)$  and color symmetry to  $U(2)$  or  $U(1)$ .

There is a way out of the problem. One can extend the  $U$ -matrix by introducing a complete orthogonal basis of wave functions in the projective sphere  $P^2$  labeling the choices  $M^4 = M^2 \times E^2$  and in the space of geodesic spheres  $S^2 \subset CP_2$ . The extended  $U$ -matrix is obtained by convoluting the factorizing  $S$ -matrix with this function basis. Completeness and orthonormalization of the basis reduce unitarity conditions for those of  $U$ -matrix for a fixed choice of  $(M^2, E^2)$  and  $(S^2, S_{\perp}^1)$  pairs.

This is not a trick but corresponds to the possibility to choose the quantization axes and the wave function in question corresponds to a wave function in the space of sub- $CD$ s and corresponding sub-WCWs defined by the different choices of quantization axes.

## 6.5 What can one say about $U$ -matrix?

For some time I thought that  $U$ -matrix could be constructed using as building bricks  $S$ -matrices of factorizing QFTs but in turned out that these  $S$ -matrices can be assigned to the scattering at quantum criticality against change of Planck constant because they have no dependence on Planck constant. The realization that  $U$ -matrix could reduce to a tensor product of  $S$ -matrices associated with  $M$ -matrices characterizing zero energy states changed the situation and it seems that this is indeed the correct interpretation. The additional nice aspect of this assumption is that  $U$ -matrix can in principle be measured experimentally.

### 6.5.1 $U$ -matrix as a tensor product of $S$ -matrix part of $M$ -matrix and its Hermitian conjugate?

$U$ -matrix describes scattering of zero energy states and since zero energy states can be illustrated in terms of Feynman diagrams one can say that scattering of Feynman diagrams is in question. The initial and final states of the scattering are superpositions of Feynman diagrams characterizing the corresponding  $M$ -matrices which contain also the positive square root of density matrix as a factor.

The hypothesis that  $U$ -matrix is the tensor product of  $S$ -matrix part of  $M$ -matrix and its Hermitian conjugate would make  $U$ -matrix an object deducible by physical measurements. One cannot of course exclude that something totally new emerges. For instance, the description of quantum jumps creating zero energy state from vacuum might require that  $U$ -matrix does not reduce in this manner (this point was discussed already earlier). One can assign to the  $U$ -matrix a square like structure with  $S$ -matrix and its Hermitian conjugate assigned with the opposite sides of a square.

One can imagine of constructing higher level physical states as composites of zero energy states by replacing the  $S$ -matrix with  $M$ -matrix in the square like structure. These states would provide a physical representation of  $U$ -matrix. One could define  $U$ -matrix for these states in a similar manner. This kind of hierarchy could be continued indefinitely and the hierarchy of higher level  $U$  and  $M$ -matrices would be labeled by a hierarchy of  $n$ -cubes,  $n = 1, 2, \dots$  TGD inspired theory of consciousness suggests that this hierarchy can be interpreted as a hierarchy of abstractions represented in terms of physical states. This hierarchy brings strongly in mind also the hierarchies of  $n$ -algebras and  $n$ -groups and this forces to consider the possibility that something genuinely new emerges at each step of the hierarchy. A connection with the hierarchies of infinite primes [?] and Jones inclusions are suggestive. Below the possibility of this kind of hierarchy for Jones inclusions is considered. The discussion relates only loosely to the recent view about  $M$ -matrix and  $U$ -matrix since it was written much before the recent view about  $M$ -matrix emerged.

### 6.5.2 The unitarity conditions of $U$ -matrix for HFFs of type $II_1$ ?

Zero energy ontology forced to give up the original hope the ordinary unitary  $S$ -matrix could directly correspond to  $U$ -matrix. For HFFs  $U$ -matrix could however decompose to a tensor product of unitary  $S$ -matrices acting between positive *resp.* negative parts of zero energy states. If these  $S$ -matrices are those assigned with the  $M$ -matrix for zero energy states,  $M$ -matrix would code information about  $U$ -matrix and be therefore measurable.

In the following  $U$ -matrix for HFF of type  $II_1$  is formally treated as a matrix with discrete indices. A rigorous treatment would be by replacing indices representing 1-D projections by projections to infinite-dimensional sub-factors having non-vanishing trace.

The unitarity conditions for the scattering of zero energy states read formally as

$$\sum_{\hat{m}_+, \hat{n}_-} U_{m_+ n_- \rightarrow \hat{m}_+ \hat{n}_-} U_{r_+ s_- \rightarrow \hat{m}_+ \hat{n}_-}^* = \delta_{m_+, r_+} \delta_{n_-, s_-} . \quad (6.5.1)$$

The sum over the final zero energy states can be also written as a trace for the product of matrices labeled by incoming zero energy states.

$$Tr(U_{m_+ n_-} U_{r_+ s_-}^*) = \delta_{m_+, r_+} \delta_{n_-, s_-} . \quad (6.5.2)$$

One can put  $s_- = n_-$  on both sides and perform the sum over  $n_-$  to get

$$\sum_{n_-} Tr(U_{m_+ n_-} U_{r_+ n_-}^*) = \delta_{m_+, r_+} \sum_{n_-} \delta_{n_-, n_-} . \quad (6.5.3)$$

This can be written as

$$\frac{1}{Tr(Id)} \sum_{n_-} Tr(U_{m_+ n_-} U_{r_+ n_-}^*) = \delta_{m_+, r_+} . \quad (6.5.4)$$

For HFFs of type  $II_1$  the sum  $\sum_{n_-} \delta_{n_-, n_-}$  is equal to the trace  $Tr(Id) = 1$  of the identity matrix so that one obtains

$$\sum_{n_-} Tr(U_{m_+ n_-} U_{r_+ n_-}^*) = \delta_{m_+, r_+} . \quad (6.5.5)$$

This could be interpreted as a unitarity condition for positive and negative energy parts of the zero energy state are interpreted as incoming and outgoing state.

This result allows to consider the possibility that  $U$ -matrix between zero energy states could define also  $M$ -matrix for HFFs of type  $II_1$ . The almost triviality of  $U$ -matrix however suggests that this is not a good idea. The construction of  $M$ -matrix as time-like entanglement coefficients allowing to understand thermodynamics as part of quantum theory provides further support for this belief.

The interpretation of the result would be as a thermal expectation value of the unitarity condition in the sense of hyper-finite factors of type  $II_1$ . This averaging is necessary if one does not have any control over the scattering between zero energy states: this scattering is just a means to become conscious about the existence of the state we usually interpret as change of state.

### 6.5.3 $U$ -matrix can have elements between different number fields

The argument for the number theoretical universality applies as such only to the matrix elements of  $U$ -matrix between different number fields. One can quite well consider the possibility that  $U$  matrix in the general case is non-algebraic since one can restrict the 3-surfaces contributing to this kind of transitions in such a manner that only algebraic numbers appear in the matrix elements of  $U$ . Unless this is the case, one could argue that physics reduces to purely algebraic physics so that one can forget both reals and  $p$ -adics.

This picture would conform with the idea that only those light-like 3-surfaces for which "physics is algebraic" are associated with the transitions between different number fields. One can say that these 3-surfaces would define a back of book along which leakage between different number fields occurs. For configuration space spinor fields in sectors corresponding to different number fields the "overlap integral" defining  $U$ -matrix elements would involve only the 3-surfaces in the back of the book. These surfaces would be in exactly the same role as rationals and algebraic numbers in number theory. The transitions between different number fields would represent a critical phenomenon in complete analogy with the criticality against phase transitions changing the value of Planck constant. Therefore the quantum criticality of TGD Universe would have very many facets. An interesting conjecture is that these surfaces are labeled by infinite rationals and algebraics so that the analogy with number theory would be much deeper [?].

What the statement "physics is algebraic" means is not quite obvious.

1. Both the field equations associated with extremals of Kähler action and modified Dirac equation represents a  $p$ -adically sensible statement. The anticommutation relations for the finite number of eigenmodes of modified Dirac operator are algebraic. The eigenvalues of the modified Dirac operator defined by Kähler action should be algebraic for the preferred surfaces so that also the Dirac determinant defining the vacuum functional would be algebraic. Vacuum functional is conjecture to be equal to the exponent of Kähler function identifiable as Kähler action for the preferred extremal identified as 4-surface for which the second variation of Kähler action vanishes for the dynamical symmetries at least. Also these conditions are purely algebraic.
2. The strongest condition would be that the values of classical charges and quantum numbers are well-defined and same for the positive and negative energy parts of quantum states assignable to given 3-surface which contribute to the transition and that real and  $p$ -adic space-time surfaces obey same algebraic equations but interpreted in different number fields. The classical conserved quantities associated with Kähler action could be defined also in  $p$ -adic case in this kind of situation and would be identical with corresponding real quantities if they are algebraic numbers.
3. The algebraic points common to real and  $p$ -adic space-time surfaces would provide the data appearing in  $U$  so that these points much corresponds to the points of number theoretic braids which must therefore have algebraic coordinate values in preferred coordinates for  $M^4$  and  $CP_2$ .

#### 6.5.4 Feynman diagrams as higher level particles and their scattering as dynamics of self consciousness

The hierarchy of inclusions of hyper-finite factors of  $II_1$  as counterpart for many-sheeted space-time lead inevitably to the idea that this hierarchy corresponds to a hierarchy of generalized Feynman diagrams for which Feynman diagrams at a given level become particles at the next level. Accepting this idea, one is led to ask what kind of quantum states these Feynman diagrams correspond, how one could describe interactions of these higher level particles, what is the interpretation for these higher level states, and whether they can be detected.

##### Jones inclusions as analogs of space-time surfaces

The idea about space-time as a 4-surface replicates itself at the level of operator algebra and state space in the sense that Jones inclusion can be seen as a representation of the operator algebra  $\mathcal{N}$  as infinite-dimensional linear sub-space (surface) of the operator algebra  $\mathcal{M}$ . This encourages to think that generalized Feynman diagrams could correspond to image surfaces in  $II_1$  factor having identification as kind of quantum space-time surfaces.

Suppose that the modular  $S$ -matrices are representable as the inner automorphisms  $\Delta(\mathcal{M}_k^{it})$  assigned to the external lines of Feynman diagrams. This would mean that  $\mathcal{N} \subset \mathcal{M}_k$  moves inside  $calM_k$  along a geodesic line determined by the inner automorphism. At the vertex the factors  $calM_k$  to fuse along  $\mathcal{N}$  to form a Connes tensor product. Hence the copies of  $\mathcal{N}$  move inside  $\mathcal{M}_k$  like incoming 3-surfaces in  $H$  and fuse together at the vertex. Since all  $\mathcal{M}_k$  are isomorphic to a universal factor  $\mathcal{M}$ , many-sheeted space-time would have a kind of quantum image inside  $II_1$  factor consisting of pieces which are  $d = \mathcal{M} : \mathcal{N}/2$ -dimensional quantum spaces according to the identification of the quantum space as subspace of quantum group to be discussed later. In the case of partonic Clifford algebras the dimension would be indeed  $d \leq 2$ .

### The hierarchy of Jones inclusions defines a hierarchy of $S$ -matrices

It is possible to assign to a given Jones inclusion  $\mathcal{N} \subset \mathcal{M}$  an entire hierarchy of Jones inclusions  $\mathcal{M}_0 \subset \mathcal{M}_1 \subset \mathcal{M}_2 \dots$ ,  $\mathcal{M}_0 = N$ ,  $\mathcal{M}_1 = M$ . A possible interpretation for these inclusions would be as a sequence of topological condensations.

This sequence also defines a hierarchy of Feynman diagrams inside Feynman diagrams. The factor  $\mathcal{M}$  containing the Feynman diagram having as its lines the unitary orbits of  $\mathcal{N}$  under  $\Delta_{\mathcal{M}}$  becomes a parton in  $\mathcal{M}_1$  and its unitary orbits under  $\Delta_{\mathcal{M}_1}$  define lines of Feynman diagrams in  $\mathcal{M}_1$ . The concrete representation for  $M$ -matrix or projection of it to some subspace as entanglement coefficients of partons at the ends of a braid assignable to the space-like 3-surface representing a vertex of a higher level Feynman diagram. In this manner quantum dynamics would be coded and simulated by quantum states.

The outcome can be said to be a hierarchy of Feynman diagrams within Feynman diagrams, a fractal structure for which many particle scattering events at a given level become particles at the next level. The particles at the next level represent dynamics at the lower level: they have the property of "being about" representing perhaps the most crucial element of conscious experience. Since net conserved quantum numbers can vanish for a system in TGD Universe, this kind of hierarchy indeed allows a realization as zero energy states. Crossing symmetry can be understood in terms of this picture.

One might perhaps say that quantum space-time corresponds to a double inclusion and that further inclusions bring in  $N$ -parameter families of space-time surfaces.

### Higher level Feynman diagrams

The lines of Feynman diagram in  $\mathcal{M}_{n+1}$  are geodesic lines representing orbits of  $\mathcal{M}_n$  and this kind of lines meet at vertex and scatter. The evolution along lines is determined by  $\Delta_{\mathcal{M}_{n+1}}$ . These lines contain within themselves  $\mathcal{M}_n$  Feynman diagrams with similar structure and the hierarchy continues down to the lowest level at which ordinary elementary particles are encountered.

For instance, the generalized Feynman diagrams at the second level are ribbon diagrams obtained by thickening the ordinary diagrams in the new time direction. The interpretation as ribbon diagrams crucial for topological quantum computation and suggested to be realizable in terms of zero energy states in [K81] is natural. At each level a new time parameter is introduced so that the dimension of the diagram can be arbitrarily high. The dynamics is not that of ordinary surfaces but the dynamics induced by the  $\Delta_{\mathcal{M}_n}$ .

### Quantum states defined by higher level Feynman diagrams

The intuitive picture is that higher level quantum states corresponds to the self reflective aspect of existence and must provide representations for the quantum dynamics of lower levels in their own structure. This dynamics is characterized by  $M$ -matrix whose elements have representation in terms of Feynman diagrams.

1. These states correspond to zero energy states in which initial states have "positive energies" and final states have "negative energies". The net conserved quantum numbers of initial and final state partons compensate each other. Gravitational energies, and more generally gravitational quantum numbers defined as absolute values of the net quantum numbers of initial and final states do not vanish. One can say that thoughts have gravitational mass but no inertial mass.
2. States in sub-spaces of positive and negative energy states are entangled with entanglement coefficients given by  $M$ -matrix at the level below.

To make this more concrete, consider first the simplest non-trivial case. In this case the particles can be characterized as ordinary Feynman diagrams, or more precisely as scattering events so that the state is characterized by  $\hat{S} = P_{in} S P_{out}$ , where  $S$  is  $S$ -matrix and  $P_{in}$  resp.  $P_{out}$  is the projection to a subspace of initial resp. final states. An entangled state with the projection of  $S$ -matrix giving the entanglement coefficients is in question.

The larger the domains of projectors  $P_{in}$  and  $P_{out}$ , the higher the representative capacity of the state. The norm of the non-normalized state  $\hat{S}$  is  $Tr(\hat{S}\hat{S}^\dagger) \leq 1$  for  $II_1$  factors, and at the limit  $\hat{S} = S$



the norm equals to 1. Hence, by  $II_1$  property, the state always entangles infinite number of states, and can in principle code the entire  $S$ -matrix to entanglement coefficients.

The states in which positive and negative energy states are entangled by a projection of  $S$ -matrix might define only a particular instance of states for which conserved quantum numbers vanish. The model for the interaction of Feynman diagrams discussed below applies also to these more general states.

### The interaction of $\mathcal{M}_n$ Feynman diagrams at the second level of hierarchy

What constraints can one pose to the higher level reactions? How Feynman diagrams interact? Consider first the scattering at the second level of hierarchy ( $\mathcal{M}_1$ ), the first level  $\mathcal{M}_0$  being assigned to the interactions of the ordinary matter.

1. Conservation laws pose constraints on the scattering at level  $\mathcal{M}_1$ . The Feynman diagrams can transform to new Feynman diagrams only in such a manner that the net quantum numbers are conserved separately for the initial positive energy states and final negative energy states of the diagram. The simplest assumption is that positive energy matter and negative energy matter know nothing about each other and effectively live in separate worlds. The scattering matrix form Feynman diagram like states would thus be simply the tensor product  $S \otimes S^\dagger$ , where  $S$  is the  $S$ -matrix characterizing the lowest level interactions and identifiable as unitary factor of  $M$ -matrix for zero energy states. Reductionism would be realized in the sense that, apart from the new elements brought in by  $\Delta_{\mathcal{M}_n}$  defining single particle free dynamics, the lowest level would determine in principle everything occurring at the higher level providing representations about representations about... for what occurs at the basic level. The lowest level would represent the physical world and higher levels the theory about it.
2. The description of hadronic reactions in terms of partons serves as a guide line when one tries to understand higher level Feynman diagrams. The fusion of hadronic space-time sheets corresponds to the vertices  $\mathcal{M}_1$ . In the vertex the analog of parton plasma is formed by a process known as parton fragmentation. This means that the partonic Feynman diagrams belonging to disjoint copies of  $\mathcal{M}_0$  find themselves inside the same copy of  $\mathcal{M}_0$ . The standard description would apply to the scattering of the initial *resp.* final state partons.
3. After the scattering of partons hadronization takes place. The analog of hadronization in the recent case is the organization of the initial and final state partons to groups  $I_i$  and  $F_i$  such that the net conserved quantum numbers are same for  $I_i$  and  $F_i$ . These conditions can be satisfied if the interactions in the plasma phase occur only between particles belonging to the clusters labeled by the index  $i$ . Otherwise only single particle states in  $\mathcal{M}_1$  would be produced in the reactions in the generic case. The cluster decomposition of  $S$ -matrix to a direct sum of terms corresponding to partitions of the initial state particles to clusters which do not interact with each other obviously corresponds to the "hadronization". Therefore no new dynamics need to be introduced.
4. One cannot avoid the question whether the parton picture about hadrons indeed corresponds to a higher level physics of this kind. This would require that hadronic space-time sheets carry the net quantum numbers of hadrons. The net quantum numbers associated with the initial state partons would be naturally identical with the net quantum numbers of hadron. Partons and they negative energy conjugates would provide in this picture a representation of hadron about hadron. This kind of interpretation of partons would make understandable why they cannot be observed directly. A possible objection is that the net gravitational mass of hadron would be three times the gravitational mass deduced from the inertial mass of hadron if partons feed their gravitational fluxes to the space-time sheet carrying Earth's gravitational field.
5. This picture could also relate to the suggested duality between string and parton pictures [K72]. In parton picture hadron is formed from partons represented by space-like 2-surfaces  $X_i^2$  connected by join along boundaries bonds. In string picture partonic 2-surfaces are replaced with string orbits. If one puts positive and negative energy particles at the ends of string diagram one indeed obtains a higher level representation of hadron. If these pictures are dual then also in parton picture positive and negative energies should compensate each other. Interestingly,

light-like 3-D causal determinants identified as orbits of partons could be interpreted as orbits of light like string word sheets with "time" coordinate varying in space-like direction.

### Scattering of Feynman diagrams at the higher levels of hierarchy

This picture generalizes to the description of higher level Feynman diagrams.

1. Assume that higher level vertices have recursive structure allowing to reduce the Feynman diagrams to ordinary Feynman diagrams by a procedure consisting of finite steps.
2. The lines of diagrams are classified as incoming or outgoing lines according to whether the time orientation of the line is positive or negative. The time orientation is associated with the time parameter  $t_n$  characterizing the automorphism  $\Delta_{\mathcal{M}_n}^{it_n}$ . The incoming and outgoing net quantum numbers compensate each other. These quantum numbers are basically the quantum numbers of the state at the lowest level of the hierarchy.
3. In the vertices the  $\mathcal{M}_{n+1}$  particles fuse and  $\mathcal{M}_n$  particles form the analog of quark gluon plasma. The initial and final state particles of  $\mathcal{M}_n$  Feynman diagram scatter independently and the  $S$ -matrix  $S_{n+1}$  describing the process is tensor product  $S_n \otimes S_n^\dagger$ . By the clustering property of  $S$ -matrix, this scattering occurs only for groups formed by partons formed by the incoming and outgoing particles  $\mathcal{M}_n$  particles and each outgoing  $\mathcal{M}_{n+1}$  line contains an irreducible  $\mathcal{M}_n$  diagram. By continuing the recursion one finally ends down with ordinary Feynman diagrams.

## 6.6 The master formula for the U-matrix finally found?

In zero energy ontology U-matrix replaces S-matrix as the fundamental object characterizing the predictions of the theory. U-matrix is defined between zero energy states and its orthogonal rows define what I call M-matrices, which are analogous to thermal S-matrices of thermal QFTs. M-matrix defines the time-like entanglement coefficients between positive and negative energy parts of the zero energy state.

A dramatic development of ideas related to the construction of U-matrix has taken place during the last year. In particular, twistorialization becomes possible in zero energy ontology and leads to the generalization of the Yangian symmetry of  $\mathcal{N} = 4$  SUSY to TGD framework with the replacement of finite-dimensional super-conformal group of  $M^4$  with infinite-D super-conformal group assignable to partonic 2-surfaces. What is so beautiful is that the physical IR cutoff due to the formation of bound states of massless wormhole throats resolves the infrared divergence problem whereas UV divergences are solved by on mass shell propagation of wormhole throats for virtual particles. This also guarantees that Yangian invariance is not lost. There are excellent reasons to expect that the twistorial constructions generalize.

Recently quite dramatic further developments have taken place in the understanding of the notions of U-matrix, M-matrix and S-matrix- a trinity of matrices replacing in zero energy ontology the notion of S-matrix of positive energy ontology. Also twistorialization reduces to pure group theory-albeit infinite-dimensional: zero energy states define Yangian algebra. In the following I summarize these developments. It is however good to summarize first various loosely related ideas developed during years which converge to a tight pattern in the resulting conceptual framework.

1. The realization that the hermitian square roots of density matrices form infinite-D unitary algebra and that their commutativity with universal S-matrix implies that zero energy states define the generalization of Kac-Moody algebra became only after I had realized the possibility to construct U-matrix. It is this observation which reduces the construction of U-matrix (or matrices if they form algebra) to that for  $S$  is expected to correspond directly to the ordinary S-matrix. A possible interpretation of the Kac-Moody type algebra of  $U$ -matrices is in terms of scales of  $CD$ s coming as positive integer powers of two. Another possibility more in line with the usual interpretation of  $S$ -matrix as time evolution operator is that scales of  $CD$ s come as integers and these integers correspond to powers of  $S$ .

What is most fascinating is that zero energy states themselves define the symmetry algebra of the theory and that this algebra can be interpreted as a generalization of Yangian responsible

for the successes of Grassmannian twistor approach by replacing finite-dimensional conformal group of Minkowski space with infinite-dimensional super-conformal algebras associated with partonic 2-surfaces in accordance with the replacement of point-like particles with surfaces. The basic characteristic of Yangian algebra is the multilocality of its generators and zero energy states are indeed multilocal since they involve partonic surfaces at both light-like boundaries of  $CD$ . Quantum TGD reduces to pure group theory! Note only states but also dynamics is coded completely by symmetries since M-matrices code for quantum dynamics! This aspect of zero energy ontology I have not realized before.

2. In ordinary QFT Feynman diagrams are purely algebraic objects. In TGD framework they reduce to space-time topology and geometry with Euclidian regions of space-time surfaces having interpretation as generalized Feynman diagrams. At the vertices of generalized Feynman diagrams in coming partonic 2-surfaces meet just like in ordinary Feynman diagrams which means deep difference from string theory. A more general assumption is that entire 4-D lines of generalized Feynman diagram meet at vertices. This could apply to the Euclidian regions only. There is also a second kind of branching involved with the hierarchy of Planck constants [K25]. In Minkowskian regions similar meeting would take place for the branches of space-time sheets with same values of canonical momentum densities of Kähler action at the ends of  $CD$ s and have interpretation in terms of fractionization and hierarchy of Planck constants. The value of Planck constant for single branch would be effectively and integer multiple of the ordinary one. For the entire multi-sheeted structure describable naturally in terms of singular covering space of  $M^4 \times CP_2$  it would be just the ordinary value.
3. Zero energy ontology with massless external wormhole wormholes implies as such twistorialization of the theory [?] although external wormhole momenta must be assumed to be massive bounds states of massless throats. This also guarantees exact Yangian symmetry and the absence of IR divergences. If also virtual wormhole throats are massless, twistorialization takes place in strong sense. This is possible only in zero energy ontology and accepting the identification of wormhole throats as basic building blocks of particles.
4. The notion of bosonic emergence [?] means that bosonic propagators emerge as radiative loops for wormhole contacts. The emergence generalizes to all states associated with wormhole contacts and also to flux tubes having wormhole contacts at their ends. What is nice that coupling constants emerge as normalization factors of propagators. Note that for single wormhole throat as opposed to wormhole contact having two throats bosonic propagator would result as a product of two collinear fermionic propagators and have the standard form. For states with higher total number of fermions and ant-ifermons the propagator of wormhole throat behaves as  $p^n$ ,  $n > 2$ . Here however  $p$  is replaced with what I call pseudo-momentum.
5. Number theoretical universality based on the extension of physics to p-adic number fields [K71] suggest that at given level ( $CD$ ) only finite sum of diagrams appears: otherwise there is danger that one obtains sum of rational functions which is not rational anymore. This gives strong constraints on generalized Feynman diagrams at the lowest level of the hierarchy. This follows naturally if twistor diagrams are identified as sums of Feynman diagrams which are irreducible in the sense that they do not represent two subsequence scatterings. Only these diagrams contribute to twistor diagram and the number of these diagrams is finite if all particles have small mass (even photon which would eat the remaining Higgs component).
6. Category theoretical approach [?] based on planar operad proposed for few years ago fits nicely with the twistorial construction of amplitudes interpreting radiative corrections in terms of  $CD$ s within  $CD$ s picture. The generalized Feynman diagrams with radiative corrections define the analog of planar operad with disk containing within itself disks containing.... replaced with causal diamond containing causal diamonds containing....

### 6.6.1 What is the master formula for the $U$ -matrix?

The basic challenge is however still there and boils down to a simple question represented in the title. This master formula should be something extremely simple and should generalize the formula for S-matrix defined between positive energy states and identified formally as the exponential of Hamiltonian

operator. In TGD framework the notion of unitary time development is given up so that something else is required and this something else should be manifestly Lorentz invariant and characterize the interactions.

Thinking the problem from this point of view allows only one answer: replace the time evolution operator defined by the Hamiltonian with the exponent for the action containing both bosonic and fermionic term. Bosonic term is the action for preferred extremal of Kähler action, which is indeed the unique Lorentz invariant defining interactions! Fermionic term would be given by Chern-Simons Dirac action associated with light-like three surfaces and space-like 3-surfaces at the ends of *CDs*. The formula is as simple as it is obvious and still I had to use 32 years to discover it!

It took however one day to realize that the situation is not so simple as one might think first. The question is whether this action should be interpreted as the counterpart of action or effective action obtained by performing path integral in presence of external sources in QFT framework. Since one restricts space-time surfaces to preferred extremals so that there is no path integral, the only possible interpretation is as the effective action. Also the condition that one obtains fermionic propagators correctly allows only this interpretation. For the Chern-Simons Dirac action the propagator would be the inverse of the correct propagator which obviously makes no sense. For the corresponding effective action the kinetic term is replaced with propagator and correct fermionic Feynman rules result when spinor basis selected to represent generalized eigenstates of the Chern-Simons Dirac operator.

The action interpreted as a counterpart of QFT effective action reduces to the sum of fermionic and bosonic terms. To make the representation more fluent I will mean with 3-surfaces in the following either the light-like orbits of wormhole throats at which the signature of the induced metric changes or the ends of space-time sheets at the boundaries of *CDs*. Note that it is possible to have *CDs* within *CDs* and these give rise to loop corrections having interpretation as zero energy states in shorter length scale. Finite measurement resolution means that one integrates over these degrees of freedom below the resolution scale. This gives rise to discrete variant of gauge coupling evolution based on scalings by factor two for *CDs*.

The next unpleasant question was whether this *U*-matrix is actually only the *S*-matrix appearing in the expression of a given *M*-matrix as a product of a hermitian square root of density matrix and unitary *S*-matrix having interpretation as the TGD counterpart of the ordinary *S*-matrix. The physical picture suggests this strongly. This observation led to a realization that the square roots of density matrices can be identified as generators of infinite-dimensional Lie-algebra of unitary matrices. Unit norm requires that hyper-finite factor of type  $II_1$  is in question. The construction reduces to that for unitary *S*-matrix.

### 6.6.2 Universal formula for the hermitian square roots of density matrix

Zero energy ontology replaces *S*-matrix with *M*-matrix and groups *M*-matrices to rows of *U*-matrix. *S*-matrix appears as factor in the decomposition of *M*-matrix to a product of hermitian square root of density matrix and unitary *S*-matrix interpreted in standard sense.

$$M_i = \rho_i^{1/2} S .$$

Note that one cannot drop the *S*-matrix factor from *M*-matrix since *M*-matrix is neither unitary nor hermitian and the dropping of *S* would make it hermitian. The analog of the decomposition of *M*-matrix to the decomposition of Schrödinger amplitude to a product of its modulus and of phase is obvious.

The interpretation is in terms of square root of thermodynamics. This interpretation should give the analogs of the Feynman rules ordinary quantum theory producing unitary matrix when one has pure quantum states so that density matrix is projector in 1-D sub-space of state space (for hyper-finite factors of type  $II_1$  something more complex is required).

This is the case. *M*-matrices are in this case just the projections of *S*-matrix to 1-D subspaces defined by the rows of *S*-matrix. The state basis is naturally such that the positive energy states at the lower boundary of *CD* have well-defined quantum numbers and superposition of zero energy states does not contain different quantum numbers for the positive energy states. The state at the upper boundary of *CD* is the state resulting in the interaction of the particles of the initial state. Unitary of the resulting *U*-matrix reduces to that for *S*-matrix.

A more general situation allows square roots of density matrices which are diagonalizable hermitian matrices satisfying the orthogonality condition that the traces

$$\text{Tr}(\rho_i^{1/2} \rho_j^{1/2}) = \delta_{ij} .$$

The matrices span the Lie algebra of infinite-dimensional unitary group. The hermitian square roots of M-matrices would reduce to the Lie algebra of infinite-D unitary group. This does not hold true for zero energy states.

If one however assumes that  $S$  commutes with the algebra spanned by the square roots of density matrices and allows powers of  $S$  one obtains a larger algebra completely analogous to Kac-Moody algebra in the sense that powers of  $S$  takes the role of powers of  $\exp(in\phi)$  in Kac-Moody algebra generators. The commutativity of  $S$  and density matrices means that the square roots of density matrices span symmetry algebra of  $S$ . The Hermitian sub-Lie-algebra commuting with  $S$  is large: for  $SU(N)$  it would correspond to  $SU(N-1) \times U(1)$  so that the symmetry algebra is huge in infinite-D case.

A possible interpretation for the sub-space spanned by  $M$ -matrices proportional to  $S^n$  is in terms of the hierarchy of  $CD$ s. If one assumes that the size scales of  $CD$ s come as octaves  $2^m$  of a fundamental scale then one would have  $m = n$ . Second possibility is that scales of  $CD$ s come as integer multiples of the  $CP_2$  scale: in this case the interpretation of  $n$  would be as this integer: this interpretation conforms with the intuitive picture about  $S$  as TGD counterpart of time evolution operator. This interpretation could also make sense for the  $M$ -matrice associated with the hierarchy of dark matter for which the scales of  $CD$ s indeed come as integers multiples of the basic scale.

If the square roots of density matrices are required to have only non-negative eigenvalues -as I have carelessly proposed in some contexts,- only projection operators are possible for Cartan algebra so that only pure states are possible. If one allows both signs one can have more interesting density matrices and this is the only manner to obtain square root of thermodynamics. Note that the standard representation for the Cartan algebra of finite-dimensional Lie group corresponds to non-pure state. For  $\rho = Id$  one obtains  $M = S$  defining the ordinary S-matrix. The orthogonality of this zero energy state with respect to other ones requires

$$\text{Tr}(\rho_i^{1/2}) = 0$$

stating that  $SU(N = \infty)$  Lie algebra element is in question.

The reduction of the construction of  $U$  to that of  $S$  is an enormous simplification and reduces to the problem of finding the TGD counterpart of  $S$ -matrix. Note that the finiteness of the norm of  $SS^\dagger = Id$  requires that hyper-finite factor of type  $II_1$  is in question with the defining property that the infinite-dimensional unit matrix has unit norm. This means that state function reduction is always possible only into an infinite-dimensional subspace only [K82] .

The natural guess is that the Lie algebra generated by zero energy states is just the generalization of the Yangian symmetry algebra (see this) of  $\mathcal{N} = 4$  SUSY postulated to be a symmetry algebra of TGD . The characteristic feature of the Yangian algebra is the multi-locality of its generators. The generators of the zero energy algebra are zero energy states and indeed form a hierarchy of multi-local objects defined by partonic 2-surfaces at upper and lower light-like boundaries of causal diamonds. Zero energy states themselves would define the symmetry algebra of the theory and the construction of quantum TGD also at the level of dynamics -not only quantum states in sense of positive energy ontology- would reduce to the construction of infinite-dimensional Lie-algebra! It is hard to imagine anything simpler!

### 6.6.3 Bosonic part of the action

Consider now the bosonic part of the action in detail.

1. The first term is the exponent of Kähler action which is purely classical quantity defining vacuum functional as the exponent of the modified Dirac action for the interior. Since there is no path integral over 4-surfaces, the only possible interpretation for Kähler action is as the counterpart of the effective action of quantum field theories to which one can indeed assign unique field pattern one the boundary values are fixed. For the preferred extremals with boundary conditions satisfying the weak form of electric-magnetic duality Kähler action reduces to Chern-Simons term with a constraint guaranteeing the weak form of electric-magnetic duality. This constraint implies that the theory does not reduce to topological QFT. One must perform functional integral over 3-surfaces.

2. What is interesting that the Kähler action reduces to Chern-Simons action with constraint term. Could one replace exponent of real Kähler action with the imaginary one so that the situation would resemble very strongly ordinary QFT? Note however that one can also consider the replacement of imaginary unit with real unit in Chern-Simons action exponential and that in Abelian case the quantization argument for the coefficient of Chern-Simons action does not apply: the coefficient is however fixed by the weak form of electric-magnetic duality. In fact unitarity does not allow imaginary exponent: a simpler example is function space endowed with inner product defined by integration with weighting by exponent of some function. Unitarity requires real exponent.
3. Bosonic term involves also measurement interaction term which formally reduces to an addition of gauge part to Kähler gauge potential linear in momentum, color isospin and hyper charge, and possible other measured quantum numbers. This term couples space-time geometry to conserved quantum numbers and in this manner guarantees quantum classical correspondence. This term is added either to interior or with opposite sign to 3-surfaces but not both and therefore does not reduce to gauge transform. This term induces to Chern-Simons term at boundary an effective gauge term as addition to the induced Kähler gauge potential appearing in the Chern-Simons Dirac action. There it is not necessary add this term separately as done earlier.

#### 6.6.4 Fermionic part of the action

It took some time to understand the identification of the fermionic term of the action.

1. By holography the fermionic term should reduce to modified Chern-Simons Dirac action with kinetic term replaced with its inverse. Otherwise kinetic term would replace propagator in the perturbative expansion. This replacement is new as compared to the earlier work.
2. The assumption familiar already from earlier work [?] is that spinors are generalized eigen modes of Chern-Simons Dirac operator with eigenvalues given by  $\lambda^k \gamma_k$ , where  $\lambda^k$  having only  $M^4$  components is what I have called pseudo-momentum having region momentum as in Grassmannian approach to twistorialization. This gives the analog of massless propagator.

The natural assumption is that pseudo-momenta relate to the massless incoming and outgoing momenta propagating along wormhole lines via twistorial formula: in other words, the difference of pseudomomenta in the vertex of polygon to which external particle line is attached equals to the incoming real massless momentum. This allows to identify virtual particles as composites of massless wormhole throats. Incoming particles consists also of massless wormhole throats but are bound states so that their mass is quantized. The precise relationship between pseudo-momenta and real massless momenta in loops remains to be understood.

3. One could postulate the form of the fermionic effective action directly. It is also possible to obtain it by interpreting Chern-Simons Dirac action as being associated with primary spinor field and the spinor fields associated with the interior as the analog of external spinor source. These fields can be coupled to each other in standard manner by the term  $\bar{\Psi}\Phi + \bar{\Phi}\Psi$ , which couples quark and lepton chiralities but does not lead to the breaking of baryon and lepton number conservation in perturbation theory as terms of form  $\bar{\Psi}\Psi$  and  $\bar{\Phi}\Phi$  would lead. The Grassmannian path integral over  $\Phi$  gives the fermionic effective action as the integral of  $\bar{\Psi}D_{CS}^{-1}\Psi$  over 3-surface with  $D^{-1}$  identified as the propagator for Chern-Simons Dirac action. The assumption that spinors are generalized eigenmodes of  $D$  at the 3-surface implies the reduction of propagator to  $1/\lambda^k \gamma_k$  in the basis of generalized eigen modes.
4. In the spirit of holography the resulting fermionic effective action reduces to the terms assignable to 3-surfaces (as defined above) since in the interior Kähler Dirac equation is satisfied. Although Kähler Dirac action vanishes, its function of Kähler Dirac equation is highly non-trivial in holography since it correlates the modes of the induced spinor fields at different wormhole throats. One ask whether one should add to the fermionic effective action also measurement interaction term. Since this term correspond formally to a gauge term in Kähler gauge potential and is already induced by the corresponding bosonic term, the addition of this term seems un-necessary.

5. The explicit expression of the interaction term is obtained by expressing the second quantized induced spinor fields in terms of the fermionic oscillator operators. The quantization in these degrees of freedom has been discussed in [?]. Therefore the action of the exponential is completely well-defined and gives rise to a perturbation series in terms of massless pseudo-momentum propagators. The triviality of the perturbation series comes from the fact vertices are topological defined by partonic two-surfaces at which the lines of generalized Feynman diagrams meet.

### 6.6.5 Definition of U-matrix

The definition of U-matrix would be shockingly simple once the reduction to the construction of  $S$ -matrix is accepted. Just the exponential effective Chern-Simons Dirac action besides Kähler action reducing to Chern-Simons term and defining the weight for the functional integral over 3-surface. What is encouraging that the resulting  $U$ -matrix would be more or less the same as the one expected on basis of heuristic considerations.

1. The basis for bare zero energy states is obtained by using pairs of positive and negative energy states assigned to the boundaries of  $CD$  and having opposite quantum numbers. The action of the exponent of Kähler action and Chern-Simons Dirac effective action generates from these states "dressed" states and U-matrix is defined between these stressed states and bare states. M-matrix in turn is defined by the action of  $L$  on given bare zero energy states as entanglement coefficients.
2. U-matrix is automatically unitary in the fermionic degrees of freedom since the effective Chern-Simons Dirac action with the inverse of the usual kinetic term on the role of kinetic term is Hermitian operator. In bosonic degrees of freedom one expects unitarity by the analogy with finite dimensional function space endowed with inner product with vacuum functional defining the weighting. This would mean a beautiful solution to the long standing problem of how to achieve unitarity.
3. There are strong reasons to believe that a duality prevails in the sense that one can restrict the interior part of action to either the Euclidian regions of space-time surfaces defining 4-D Feynman diagram or to their Minkowskian exterior. Number theoretic vision [K72] suggests this duality and the recent considerations [?] support the same conclusion. Obviously this duality brings in mind Wick rotation of quantum field theories.
4. The fermionic action corresponds formally to free action so that there are no explicit interaction vertices: the situation in the geometric formulation of string theory is same. There is however no need for non-linear interaction terms which are also responsible for the divergences of quantum field theories. The interaction terms are replaced with topological interaction vertex at which the light-like 3-surfaces associated defining the orbits of partonic 2-surfaces (wormhole throats) meet like lines of the ordinary Feynman diagram.

Note that this vertex distinguishes between TGD and string models where trouser vertex is a typical vertex: in TGD framework this kind of geometric decay does not correspond to particle decay but to the propagation of particle along different paths. The conservation of quantum numbers is required at the vertices. Also massless-ness property for the particles propagating along the lines is natural in zero energy ontology and makes possible twistorialization with the constraint that physical particles are massive bound states of massless wormhole throats.

5. The non-trivial propagation of state with total number  $n$  of fermions and antifermions is possible only if  $n$  contractions of the propagator appears along the line (otherwise one would obtain only quark lepton contractions forbidden by conservation laws). This implies the proportionality  $1/p^n$  of the propagator so that only total fermion number  $n = 1, 2$  is possible for non-vacuum wormhole throat. This proportionality was earlier deduced from the SUSY limit of TGD based on a generalization of SUSY algebra [?]. As a consequence, wormhole contact having two throats can carry at most spin 2 and the large SUSY defined by the fermionic oscillator operators is badly broken and effectively reduced to that generated by the right-handed neutrino which is also broken.

6. The assumption that all particles have non-vanishing mass means that given state can decay only to a virtual state with finite number of particles. This together with massless propagation along virtual lines simplifies enormously the perturbation series and is expected to imply finiteness.
7. The integration over WCW could spoil the unitarity. Although the exponent of Kähler action is positive it could give rise to divergent integral if the Kähler action has definite sign. The reduction to Chern-Simons term does not make obvious the positivity. If one believes on Minkowskian-Euclidian duality in the sense that one can define vacuum functional either as the exponent of Kähler action for the Minkowskian or Euclidian regions, one obtains definite sign for the Kähler function since for the Euclidian signature Kähler action indeed has definite sign. What is remarkable that in Chern-Simons term the non-analytic  $1/g_K^2$  dependence on Kähler coupling strength disappears by the the weak form of electric-magnetic duality so that perturbation series with respect to the small parameter  $g_K^2$  should make sense. One expects that this expansion gives small contributions to coupling constants determined in lowest order by bosonic emergence and involving fermionic loops.
8. The resulting generalized Feynman diagrammatics differs from the standard one in many respects. The lines of Feynman diagrams are replaced with 3-surfaces in the sense specified above. Only a very restricted subset of loops are allowed classically by preferred extremals. The massless on mass shell property for wormhole throat momenta indeed allows very restricted phase space for loops. If all particles are massive bound states of massless wormhole throats intermediate virtual particles states with positive energies can contain only a finite number of particles so that the situation simplifies dramatically. The already mentioned collinear many-fermion states with propagator behaving like  $1/p^n$ ,  $n > 2$  are also present. Hence one can ask whether a more appropriate identification of generalized Feynman diagrams might be as counterparts of twistor diagrams.

### 6.6.6 What is the relationship of generalized Feynman diagrams to twistor diagrams?

The general idea about the construction of U-matrix gives strong support for the existing heuristics and provides a connection with category theoretical ideas (planar operads and generalized Feynman diagrammatics [?]) and also suggests a generalization of twistor diagrammatics. Many questions of course remain unanswered. The basic question is the relationship of generalized Feynman diagrams with twistor diagrams. There are arguments favoring also the interpretation as direct counterparts of twistor diagrams. The following series of arguments however favors Feynman diagram interpretation and leads to a precise connection between the two diagrammatics. The arguments rely on following general ideas which deserve to be restated.

#### What is the correct identification of pseudo-momenta

The modified Dirac equation gives as generalized eigenvalues the quantities  $\lambda^k \gamma_k$ . I have christen  $\lambda$  as f pseudo-momentum and proposed number theoretic quantization rules for the values of pseudo-momenta [?] The physical interpretation of pseudo-momenta is still open as is also their relationship to massless on mass shell momenta propagating in wormhole throats associated with virtual particles. It is convenient to consider wormhole contact with two wormhole throats as a representation of incoming or virtual particle. The questions are following.

1. Is there a summation over pseudo-momenta for wormhole throats such that the sum of pseudo-momenta equals to the total exchanged real momentum associated with the wormhole contact. The real momenta on virtual line would be massless and give strong kinematic conditions on phase space allowed in loops.

Physical propagators from wormhole contacts would result as self energy loops for pseudo-momenta and there is the danger of getting divergences unless one uses the number theoretic conditions to reduce the summation as proposed. This picture would realize the idea about the emergence of bosonic propagators as fermionic radiative corrections and also more general propagators. Coupling constants would be predicted and appear in the normalization of bosonic



propagators. Note that also the integration over WCW degrees of freedom affects the values of coupling constants.

The question is how strong additional conditions the number theoretic quantization of pseudo-momenta poses on the exchanged massless real momenta depends on the strength of number theoretical conditions. Are these conditions sensible?

2. Can one really identify pseudo-momenta really identifiable as region momenta of the twistor approach as I have cautiously suggested? The above line of arguments does not encourage this interpretation. Whether the identification makes sense can be tested immediately by looking for the dependence of Grassmannian twistor amplitudes on pseudo-momenta. If it is of standard propagator form one can consider this interpretation.

### Connection between generalized Feynman diagrams and generalized twistor diagrams

The connection between generalized Feynman diagrams and generalized twistor diagrams should be understood.

1. The natural manner to identify twistor diagrams for a given  $CD$  without radiative corrections given by the addition of sub- $CD$ s would be as the diagrams obtained by connecting the points or upper and lower boundaries of  $CD$  to form a polygon. There are several manners to do this. The differences of region-momenta would give the massless momenta for each external wormhole throat. Region momenta would have nothing to do with pseudo-momenta.
2. Twistor diagrams would represent sum for a subset of allowed generalized Feynman diagrams with massless particles in internal lines. On mass shell condition for massless wormhole throats restricts dramatically the number of contributing diagrams and the assumption that all particles have at least small mass means that particle numbers in intermediate states are finite. One however obtains infinite number of diagrams obtained as series of allowed diagrams. The problem is that although individual diagrams give rational functions, an infinite sum of them leads out from the algebraic extensions of p-adic numbers and rationals. This does not conform with number theoretic universality.

Therefore only irreducible diagrams not decomposing to series of allowed scatterings are allowed. As a consequence only finite number of diagrams are possible. The sum of these diagrams would correspond to a given basic twistor diagram. One could consider also the condition that at given length scaled determined by  $CD$  only tree diagrams are allowed. but this option looks ad hoc.

The addition of sub- $CD$ :s would give radiative corrections from shorter length scales and the depth of the hierarchy of  $CD$ s within  $CD$ s hierarchy defines the IR and UV cutoffs and measurement resolution. If one accepts the assumption that the sizes of  $CD$  come as octaves of  $CP_2$  time scale, there would be natural IR and UV cutoffs on the values of pseudo-momenta from p-adic length scale hypothesis so that the amplitudes should remain finite and there would no fear about the loss of number theoretic universality. Note that in zero energy ontology cutoffs would characterize physical states themselves rather than restrictions of physicist only.

### Diagrammatics based on gluing of twistor amplitudes

Radiative corrections n shorter scales than that of  $CD$  would result from the gluing of basic amplitudes for  $CD$ s within  $CD$ s.

1. Radiative corrections could be organized in terms of twistor diagrams. The rule transforming twistor polygons to simplest Feynman diagrams is standard duality replacing polygon with external lines at vertices with a bundle of lines obtained by connecting external lines to same point in the interior of the polygon. For triangle this gives three vertex. For n-polygon this would give n-vertex which corresponds to tree diagram as a Feynman diagram.

For instance, one can understand self energy corrections in this framework in terms of two twistorial triangles with two edges of both connected by two lines. Again on mass shell massless holds true for the throats. Vertex correction corresponds to triangle triangle within triangle with vertices of the inner triangle connected to the vertices of the outer triangle.. One obtains radiative corrections from this picture.

2. Also now one can have loops obtained as a closed ring of polygons connected to each other. There are also much more complex configurations of polygons. Unless one allow splitting of wormhole contacts the wormhole lines associated with a given wormhole throat end up to single  $CD$ .
3. For an outgoing pair of wormhole lines from given  $CD$  the wormhole throats should have same sign of energy: this would mean that only time-like momenta can propagate between  $CD$ s so that space-like loop momenta would be possible only for the fundamental radiative corrections. This would a further strong restriction on the amplitudes and space-like momentum exchanges would come from the fundamental level involving only a finite number of diagrams.

Is this good or bad? If bad, should one be ready to assign independent  $CD$ s with the two wormhole throats? Or should the interpretation be that the wormhole contact is split and wormhole throats propagate in two different time directions? But is it possible to speak about single space-like momentum exchange if the wormhole contact is split. Note that pseudo-momentum propagator for wormhole throat would still make sense. This line of thought does not look attractive.

4. Massless particles assigned with wormhole lines connecting the polygons and net pseudo-momenta are not on mass shell. Apart from time-likeness of net momenta, the rules for the propagators seem exactly the same as for polygons. These rules would summarize how radiative corrections from shorter scales are obtained.

### The generalization of the recursion formula to TGD framework

The great victory of twistor approach is the recursion formula for the amplitudes [?] (see also the representation in TGD framework [?] ) applying to all planar diagrams of  $N = 4$  SYM becoming an exact formula at the large  $N$  limit for gauge group  $SU(N)$ . In the recent case the infinite-dimensional character of the Yangian symmetry algebra of S-matrix could be correlate for large  $N$  limit so that the planar limit should make sense. Also the fact that string worlds sheets are an essential aspect of TGD approach suggests that stringy picture deduced by t'Hooft for gauge theories at this limit implies planarity. What is relevant in the recent case is the general structure of the reduction formula, not the details which as such are of course extremely interesting also in TGD framework since Grassmannian amplitudes are claimed to provide a universal representation of Yangian invariants.

The recursive formula expresses scattering amplitude with  $n$  external particles with  $k$  negative helicities up to  $l$  loops is expressible as a sum of two terms. The first term-referred to as classical contribution- involves a fusion of twistor amplitudes with smaller number of particles and with the number of loops not larger than  $l$  by a procedure used already for tree diagrams. Second term - called quantum contribution- involves  $l$  loops and is irreducible in the sense that it is not expressible as a fusion of lower amplitudes and is obtained from  $n + 2$  particle by a process eliminating two particles. The identification of the TGD counterparts of these terms is obvious. The "classical" term corresponds to the proposed fusion of the lower level amplitudes associated with polygons for sub- $CD$ s. The "quantum" term corresponds to the contribution appearing at the level of  $CD$  itself and involves genuine loops in Feynman sense but only a finite number of them.

Since zero energy states correspond to generators of Yangian algebra or rather- its Kac-Moody variant with integer power of phase factor identified as integer power of  $S$ , the recursion formula might allow an interpretation as a direct counterpart for the recursive definition of Yangian algebra in terms of relations allowing the construction of generators labeled by non-negative integers.

### TGD counterpart for the duality of Feynman diagrams for twistors and Wilson loops for momentum twistors

One of the fascinating discoveries of twistor Grassmannian approach is that conformal invariance and its dual correspond in twistor approach to descriptions in terms of twistors in ordinary Minkowski space by starting from Feynman diagrams and in terms of momentum twistors in its dual by starting from Wilson loops. Also this duality has counterpart in TGD.

String world sheets are an essential part of quantum TGD and the translation of Witten's work with knots to TGD context led to a precise identification of string world sheets and a deep connection between TGD and the theory of knots, braids, braid cobordisms, and 2-knots emerges [?] .

Amusingly, the basic idea of this connection emerged from the model of DNA as topological quantum computer [K24] developed for few years ago. The braiding defining the quantum computation is time-like and can be illustrated using dance metaphor: the world lines of dancers define the running topological computation program. If you connect the feet of dancers to a wall with threads (dancers are lipids at cell membrane forming 2-D liquid, wall is represented by DNA nucleotide sequence, and threads are magnetic flux tubes), the threads entangle during dance and give rise to a space-like braiding and code the computer program to memory: a fundamental mechanism of memory. These braidings are clearly dual and this duality relates closely to the duality just to the duality between Feynman graphs and Wilson loops! The time evolution of this space-like braiding defines braid cobordism and also a 2-knot.

The natural implication of strong form of holography made possible by preferred extremal (Bohr orbit in generalized sense) property of space-time surfaces is that the descriptions in terms of string world sheets and partonic 2-surfaces are dual. The twistorial representation of this duality is as the duality of descriptions in terms of Feynman diagrammatics in ordinary space-time and Wilson sheets-rather than loops- in the dual space-time assigned with region momenta.

### 6.6.7 Generalized twistor diagrams and planar operads

The resulting diagrams would have very close resemblance to structures known as planar operads [?, ?] associated with both topological quantum field theories and subfactors of von Neumann algebras. Planar operads provide a graphic representation of these structures. Since TGD corresponds to almost topological QFT and since WCW ("world of classical worlds") Clifford algebras correspond to von Neumann algebras known as hyper-finite factors of type II<sub>1</sub> [K82], the natural expectation is that generalized Feynman diagrams correspond to planar operads. This is indeed what I proposed for three years ago in [?] but with disks replaced with *CDs* so that a the recent view unifies several earlier visions.

An additional motivation for the operad picture came from the notion of super-symplectic analog of super-conformal field theory motivated by the assumption that the symplectic transformations of  $\delta M_{\pm}^4 \times CP_2$  act as isometries of WCW. The fusion rules of super-symplectic QFT lead to an infinite hierarchy of algebras forming an operad.

The basic structure of planar operad is very much reminiscent of generalized twistor diagrams.

1. One has essentially disks within disks connected by lines. The modification is obvious. Replace disks within disks disks with *CDs* within *CDs* and assign to the upper *resp.* lower boundaries of *CDs* positive *resp.* negative energy states. Many-sheeted space-time allows locally two *CDs* above each other corresponding to the identification of particles as wormhole contacts.
2. The planarity of the operad would be an obvious correlate for the absence of non-planar loops in twistor approach to  $N = 4$  SUSY making it problematic. Stringy picture actually suggests the absence of non-planar diagrams. The proposed generalization of twistor diagrammatics allowing arbitrary polygons within polygons structure might be enough to compensate for the absence of non-planar diagrams.

To sum up, the recent view generalizes considerably twistor diagrammatics and gives a connection with hyper-finite factors of type II<sub>1</sub> and with planar operads. The identification of virtual states as composites of massless states is extremely natural in this framework. The construction is also consistent with the heuristic picture about generalized Feynman diagrams and with the earlier proposal about role of the planar operad. For these reasons I dare to expect that a big step towards precise form of the rules has been made

## 6.7 Anatomy of quantum jump in zero energy ontology

Consider now the anatomy of quantum jump identified as a moment of consciousness in the framework of ZEO [K42].

1. Quantum jump begins with unitary process  $U$  described by unitary matrix assigning to a given zero energy state a quantum superposition of zero energy states. This would represent the creative aspect of quantum jump - generation of superposition of alternatives.

2. The next step is a cascade of state function reductions proceeding from long to short scales. It starts from some  $CD$  and proceeds downwards to sub- $CD$ s to their sub- $CD$ s to ..... At a given step it induces a measurement of the quantum numbers of either positive or negative energy part of the quantum state. This step would represent the measurement aspect of quantum jump - selection among alternatives.
3. The basic variational principle is Negentropy Maximization Principle (NMP) [K42] stating that the reduction of entanglement entropy in given quantum jump between two subsystems of  $CD$  assigned to sub- $CD$ s is maximal. Mathematically NMP is very similar to the second law although states just the opposite but for individual quantum system rather than ensemble. NMP actually implies second law at the level of ensembles as a trivial consequence of the fact that the outcome of quantum jump is not deterministic.

For ordinary definition of entanglement entropy this leads to a pure state resulting in the measurement of the density matrix assignable to the pair of  $CD$ s. For hyper-finite factors of type  $II_1$  (HFFs) state function reduction cannot give rise to a pure state and in this case one can speak about quantum states defined modulo finite measurement resolution and the notion of quantum spinor emerges naturally. One can assign a number theoretic entanglement entropy to entanglement characterized by rational (or even algebraic) entanglement probabilities and this entropy can be negative. Negentropic entanglement can be stable and even more negentropic entanglement can be generated in the state function reduction cascade.

The irreversibility is realized as a property of zero energy states (for ordinary positive energy ontology it is realized at the level of dynamics) and is necessary in order to obtain non-trivial U-matrix. State function reduction should involve several parts. First of all it should select the density matrix or rather its Hermitian square root. After this choice it should lead to a state which prepared either at the upper or lower boundary of  $CD$  but not both since this would be in conflict with the counterpart for the determinism of quantum time evolution.

### 6.7.1 Generalization of S-matrix

ZEO forces the generalization of S-matrix with a triplet formed by U-matrix, M-matrix, and S-matrix. The basic vision is that quantum theory is at mathematical level a complex square roots of thermodynamics. What happens in quantum jump was already discussed.

1. U-matrix as has its rows M-matrices, which are matrices between positive and negative energy parts of the zero energy state and correspond to the ordinary S-matrix. M-matrix is a product of a hermitian square root - call it  $H$  - of density matrix  $\rho$  and universal S-matrix  $S$  commuting with  $H$ :  $[S, H] = 0$ . There is infinite number of different Hermitian square roots  $H_i$  of density matrices which are assumed to define orthogonal matrices with respect to the inner product defined by the trace:  $Tr(H_i H_j) = 0$ . Also the columns of U-matrix are orthogonal. One can interpret square roots of the density matrices as a Lie algebra acting as symmetries of the S-matrix.
2. One can consider generalization of M-matrices so that they would be analogous to the elements of Kac-Moody algebra. These M-matrices would involve all powers of  $S$ .
  - (a) The orthogonality with respect to the inner product defined by  $\langle A|B \rangle = Tr(AB)$  requires the conditions  $Tr(H_1 H_2 S^n) = 0$  for  $n \neq 0$  and  $H_i$  are Hermitian matrices appearing as square root of density matrix.  $H_1 H_2$  is hermitian if the commutator  $[H_1, H_2]$  vanishes. It would be natural to assign  $n$ :th power of  $S$  to the  $CD$  for which the scale is  $n$  times the  $CP_2$  scale.
  - (b) Trace - possibly quantum trace for hyper-finite factors of type  $II_1$  is the analog of integration and the formula would be a non-commutative analog of the identity  $\int_{S^1} exp(in\phi) d\phi = 0$  and pose an additional condition to the algebra of M-matrices. Since  $H = H_1 H_2$  commutes with S-matrix the trace can be expressed as sum  $\sum_{i,j} h_i s_j(i) = \sum_{i,j} h_i(j) s_j$  of products of correspondence eigenvalues and the simplest condition is that one has either  $\sum_j s_j(i) = 0$  for each  $i$  or  $\sum_i h_i(j) = 0$  for each  $j$ .

- (c) It might be that one must restrict M-matrices to a Cartan algebra for a given U-matrix and also this choice would be a process analogous to state function reduction. Since density matrix becomes an observable in TGD Universe, this choice could be seen as a direct counterpart for the choice of a maximal number of commuting observables which would be now hermitian square roots of density matrices. Therefore ZEO gives good hopes of reducing basic quantum measurement theory to infinite-dimensional Lie-algebra.

### 6.7.2 A concise description of quantum jump

In the following a minimalistic view about quantum jump is described. Both U-process and state preparation reduce to state function reductions to two basis for zero energy states characterized by opposite arrows of geometric time.

#### Unitary process and choice of the density matrix

The basic question concerning U process is which of the following two options U-process corresponds to.

1. U-process occurs for zero energy states. U-matrix would be defined in the space of zero energy states and would represent kind of higher order scattering whereas M-matrix and S-matrix as time-like entanglement coefficients would describe what happens in a scattering experiment. This kind of possibility can be certainly considered since one can form zero energy states using zero energy states as building bricks. Entire hierarchy of zero energy states could be constructed in this manner.
2. U-process can be said to occur for either positive or negative energy parts of zero energy states. This option is definitely minimal and in this case U-process for positive (negative) energy part of the state is dual to state function reduction for the negative (positive) energy part of the state. Furthermore, state function reduction is dual to state preparation. For this reason this option deserves to be called minimalistic.

During years I have considered both options without clearly distinguishing between them. The notion of time is very difficult concept: we do not have brain for time. Below I will consider only the minimalistic option in the hope that Nature would prefer minimalism also at this time. There is no need to emphasize how speculative these considerations are.

Consider first unitary process followed by the choice of the density matrix for the minimalistic option.

1. There are two natural state basis for zero energy states. The states of these state basis are prepared at the upper or lower boundary of  $CD$  respectively and correspond to various M-matrices  $M_K^+$  and  $M_L^-$ . U-process is simply a change of state basis meaning a representation of the zero energy state  $M_K^\pm$  in zero energy basis  $M_K^\mp$  followed by a state preparation to zero energy state  $M_K^\pm$  with the state at second end fixed in turn followed by a reduction to  $M_L^\mp$  to its time reverse, which is of same type as the initial zero energy state.

The state function reduction to a given M-matrix  $M_K^\pm$  produces a state for the state is superposition of states which are prepared at either lower or upper boundary of  $CD$ . It does not yet produce a prepared state on the ordinary sense since it only selects the density matrix.

2. The matrix elements of U-matrix are obtained by acting with the representation of identity matrix in the space of zero energy states as

$$I = \sum_K |K^+\rangle \langle K^+|$$

on the zero energy state  $|K^-\rangle$  (the action on  $|K^+\rangle$  is trivial!) and gives

$$U_{KL}^+ = Tr(M_K^+ M_L^+) .$$

In the similar manner one has

$$U_{KL}^- = (U^{+\dagger})_{KL} = Tr(M_L^- M_K^-) = \overline{U_{LK}^+} .$$

These matrices are Hermitian conjugates of each other as matrices between states labelled by positive or negative energy states. The interpretation is that two unitary processes are possible and are time reversals of each other. The unitary process produces a new state only if its time arrow is different from that for the initial state. The probabilities for transitions  $|K_+\rangle \rightarrow |K_-\rangle$  are given by  $p_{mn} = |Tr(M_K^+ M_L^+)|^2$ .

### State function preparation

Consider next the counterparts of the ordinary state preparation process.

1. The ordinary state function process can act either at the upper or lower boundary of  $CD$  and its action is thus on positive or negative energy part of the zero energy state. At the lower boundary of  $CD$  this process selects one particular prepared states. At the upper boundary it selects one particular final state of the scattering process.
2. Restrict for definiteness the consideration to the lower boundary of  $CD$ . Denote also  $M_K$  by  $M$ . At the lower boundary of  $CD$  the selection of prepared state - that is preparation process - means the reduction

$$\sum_{m^+ n^-} M_{m^+ n^-}^\pm |m^+\rangle |n^-\rangle \rightarrow \sum_{n^-} M_{m^+ n^-}^\pm |m^+\rangle |n^-\rangle .$$

The reduction probability is given by

$$p_m = \sum_{n^-} |M_{m^+ n^-}|^2 = \rho_{m^+ m^+} .$$

For this state the lower boundary carries a prepared state with the quantum numbers of state  $|m_+\rangle$ . For density matrix which is unit matrix (this option giving pure state might not be possible) one has  $p_m = 1$ .

### State function reduction process

The process which is the analog of measuring the final state of the scattering process is also needed and would mean state function reduction at the upper end of  $CD$  - to state  $|n^-\rangle$  now.

1. It is impossible to reduce to arbitrary state  $|m_+\rangle |n_-\rangle$  and the reduction must at the upper end of  $CD$  must mean a loss of preparation at the lower end of  $CD$  so that one would have kind of time flip-flop!
2. The reduction probability for the process

$$|m_+ \equiv \sum_{n^-} M_{m^+ n^-} |m^+\rangle |n^-\rangle \rightarrow n_- = \sum_{m^+} M_{m^+ n^-} |m^+\rangle |n^-\rangle$$

would be

$$p_{mn} = |M_{mn}^2| .$$

This is just what one would expect. The final outcome would be therefore a state of type  $|n^-\rangle$  and - this is very important- of the same type as the state from which the process began so that the next process is also of type  $U^+$  and one can say that a definite arrow of time prevails.

3. Both the preparation and reduction process involves also a cascade of state function reductions leading to a choice of state basis corresponding to eigenstates of density matrices between subsystems.

### 6.7.3 Questions and answers

Answering to question in the best possible manner to develop ideas in more comprehensible form. In this respect the questions of Hamed at my blog have been especially useful. Many questions below are made by him and inspired the objections, many of them discussed also in previous discussions.

**Question:** The minimalistic option suggests very strongly that our sensory perception can be identified as quantum measurement assignable to state function reductions for upper or lower boundaries of our personal CD. Our sensory perception does not however jump between future and past boundaries of our personal CD (containing sub-CDS in turn containing)! Why?

**Possible answer:** If our sensory perception is about CD which is much bigger than personal CD the problem disappears. We perceive from day to day the -say- positive energy part of a state assignable to this very big CD. The world looks rather stable. **Question:** Could our sensory perception actually do this jumping so that sensory inputs are alternatively about upper and lower boundaries of personal CD? Could sleep-awake cycle correspond to this flip flop?

**Possible answer:** The geometric time span for quantum jumps in question would correspond to the geometric time scale for our personal CD. In wake-up state we are performing state function reduction at the upper boundary of our personal CD and sensory mental images as sub-CDS are concentrated there. When we are asleep, same happens at lower boundary of CD and sensory mental images are there (dreams,).

**Question:** What is the time scale assignable to my personal CD: the typical wake-up cycle: 24 hours? Or of the order of life span. Or perhaps shorter? Why we do not remember practically anything about sensory perceptions during sleep period? (Note that we forget actively dream experiences). Does the return to childhood at old age relate with this time flip-flop in the scale of life span: do we re-incarnate in biologically death at opposite end of CD with scale of life span?

**Possible answer:** These are interesting possibilities. The explanation would be that for some reason we do not have many memories about dream time existence? We certainly forget very rapidly dream experiences. Is this process active and is it purpose to avoid the mixing of two realities? Or is it due to the fact that the required communications to geometric past are over so long time interval that the attempts to remember fail? Could dream memories represent memories about the period in which our sensory percepts correspond to past boundary of CD? If this boundary corresponds to time scale of life cycle, the memories would be about childhood. Dreams are often located to the past and childhood.

**Question:** How the arrow of geometric time at space-time level emerges from the arrow of geometric time for zero energy states? Why do we experience that we move along space-time sheets to geometric future or equivalently: space-time sheets move with respect to us to geometric past?

**Possible answer:** The proposal (one of the many, see [?]), which can be easily ridiculed, is that the state function reductions performed by sub-selves assignable to sub-CDS at the boundary of personal CD and representing mental images induce small time translations of space-time sheet tending to shift it as a whole to past: this induces the arrow of geometric time. Space-time sheet is like film which the curious audience in the movie theatre shifts to a preferred direction. I have described this movie theatre metaphor in more detail in [?].

The sub-selves representing sensory mental images are tiny conscious entities and would be very curious! News are in the geometric future assignable to the space-time sheet and they want to know what is there and they use their volitional resources to induce a small shift to geometric past.

Why selves would be "curious"? Could this be understood in terms of Negentropy Maximization Principle (NMP) [K42] stating that the information gain in quantum jump is maximal or by postulating a generalization of NMP Selves would be hungry information eaters. As a matter fact, according to TGD inspired quantum biology our endless hunting of metabolic energy would not be about getting energy but negentropy associated with the entanglement [K33].

**Question:** Can the arrow of time change?

**Possible answer:** A highly interesting question is what happens if the first state preparation leading to a state  $|k^+\rangle$  is followed by a U-process of type  $U^-$  rather than by the state function

reduction process  $|k^+\rangle \rightarrow |l^-\rangle$ . Does this mean that the arrow of geometric time changes? Could this change of the arrow of geometric time take place in living matter? Could processes like molecular self assembly be entropy producing processes but with non-standard arrow of geometric time? Or are they processes in which negentropy increases by the fusion of negentropic parts to larger ones? Could the variability relate to sleep-awake cycle and to the fact that during dreams we are often in our childhood and youth. Old people are often said to return to their childhood. Could this have more than a metaphoric meaning? Could biological death mean return to childhood at the level of conscious experience? I have explained the recent views about the arrow of time in [?].

One can consider also other views for the generation of arrow of time. Instead of the time coordinate for space-time surface one can also consider time coordinate for imbedding space or rather  $CD$ . For instance, one can ask how the arrow of cosmic time identifiable as lightcone proper time assignable to  $CD$  could be generated. sub- $CD$ s have localization inside bigger  $CD$  containing them and one can quite well imagine that sub- $CD$ s within  $CD$  drift towards geometric future of  $CD$  quantum jump by quantum jump and this gives rise to the experience of the time flow based on clock defined by changing environment. This drifting could occur towards or away from boundaries of  $CD$  and would be in opposite directions at the two boundaries. Various possibilities are discussed in [?].

One can also imagine that the experience about flow of geometric time corresponds to a state function reduction cascae at upper boundaries of sub- $CD$ s proceeding from the lower boundary to upper boundary of  $CD$  containing them. The preferred direction for the cascae would be dictated by the arrow of time assignable to the zero energy states associated with  $CD$ .

To sum up, there are several candidates for the mechanism behind the arrow of geometric time and it would be too early to select any mechanism as *the* mechanism.

#### 6.7.4 More about the anatomy of state function reduction

In a comment to previous posting Ulla gave a link to an interesting article by George Svetlichny [?] describing an attempt to understand free will in terms of quantum measurement. After reading of the article I found myself explaining once again to myself what state function reduction in TGD framework really means.

##### The proposal of Svetlichny

The basic objection against assigning free will to state function reduction in the sense of wave mechanics is that state function reduction from the point of view of outsider is like playing dice. One can of course argue that for an outsider *any* form of free will looks like throwing a dice since causally effective experience of free will is accompanied by non-determinism. We simply do not know what is the experience possibly associated with the state function reduction. The lesson is that we must carefully distinguish between two levels: the single particle level and ensemble level - subjective and objective. When we can say that something is random, we are talking about ensembles, not about single member of ensemble.

The author takes the objection seriously and notices that quantum measurement means a division of system to three parts: measured system, measuring system and external world and argues that in some cases this division might not be unique. The choice of this division would have interpretation as an act of free will. I leave it to the reader can decide whether this proposal is plausible or not.

##### TGD view about state function reduction

What can one say about the situation in TGD framework? There are several differences as compared to the standard measurement "theory", which is just certain ad hoc rules combined with Born rule, which applies naturally also in TGD framework and which I do not regard as adhoc in infinite-D context.

In the sequel I will discuss the possible anatomy of the state function reduction part of the quantum jump.

1. TGD ontology differs from the standard one. Space-time surfaces and quantum states as such are zombies in TGD Universe: consciousness is in the quantum jump. Conscious experience is in the change of the state of the brain, brain state as such is not conscious. Self means integration of quantum jumps to higher level quantum jumps and the hierarchy of quantum jumps and



hierarchy of selves can be identified in ZEO. It has the hierarchy of  $CD$ s and space-time sheets as geometrical correlates. In TGD Universe brain and body are not conscious: rather, conscious experience is about brain and body and this leads to the illusion caused by the assimilation with the target of sensory input: I am what I perceive.

2. In TGD framework one does not assume the division of the system to a product of measured system, measuring system, and external world before the measurement. Rather, this kind of divisions are outcomes of state function reduction which is part of quantum jump involving also the unitary process. Note that standard measurement theory is not able to say anything about the dynamics giving rise to this kind of divisions.
3. State function reduction cascade as a part of quantum jump - this holistic view is one new element - proceeds in zero energy ontology (ZEO) from long to short length scales  $CD \rightarrow sub-CDs \rightarrow \dots$ , and stops when Negentropy Maximization Principle (NMP [K42] defining the variational principle of consciousness is also something new) does not allow to reduce entanglement entropy for any subsystem pair of subsystem un-entangled with the external world. This is the case if the sub-system in question is such that all divisions to two parts are negentropically entangled or form an entangled bound state.

An interesting possibility is that negentropic entanglement does not correspond to bound state entanglement. The negentropically entangled particles would remain correlated by NMP rather than being in the jail defined by the interaction potential. I have proposed that this analog of love marriage could be fundamental for understanding living matter and that high energy phosphate bond central for ADP-ATP process could involve negentropic entanglement [K33].

For a given subsystem occurring in the cascade the splitting into an unentangled pair of measured and measuring system can take place if the entanglement between these subsystems is entropic. The splitting takes place for a pair with largest entanglement entropy and defines measuring and measured system.

Who measures whom? This seems to be a matter of taste and one should not talk about measuring system as conscious entity in TGD Universe, where consciousness is in quantum jump.

4. The factorization of integer to primes is a rather precise number theoretical analogy for what happens, and the analogy might actually have a deeper mathematical meaning since Hilbert spaces with prime dimension cannot be decomposed into tensor products. Any factorization of integer to a product of primes corresponds to a cascade of state function reductions. At the first step division takes place to two integers and several alternative divisions are possible. The pair for which the reduction of entanglement entropy is largest, is preferred. The resulting two integers can be further factorized to two integers, and the process continues and eventually stops when all factors are primes and no further factorization is possible.

One could even assign to any decomposition  $n = rs$  the analogs of entanglement probabilities as  $p_1 = \log(r)/\log(n)$  and  $p_2 = \log(s)/\log(n)$ . NMP would favor the divisions to factors  $r$  and  $s$  which are as near as possible to  $n/2$ .

Negentropically entangled system is like prime. Note however that these systems can still make an analog of state function reduction which does not split them but increases the negentropy for all splittings of system to two parts. This would be possible only in the intersection of real and p-adic worlds, that is for living matter. My cautious proposal is that just this kind of systems - living systems - can experience free will: either in the analog of state function reduction process increasing their negentropy or in state function process reducing their entanglement with environment.

5. In standard measurement theory observer chooses the measured observables and the theory says nothing about this process. In TGD the measured observable is the density matrix for a pair formed by any two entangled parts of sub-system division for which negentropy gain is maximal in quantum measurement defines the pair. Therefore both the measurement axis and the pair representing the target of measurement and measurer are selected in quantum jump.

6. Quantum measurement theory assumes that measurement correlates classical long range degrees of freedom with quantal degrees of freedom. One could say that the direction of the pointer of the measurement apparatus correlates faithfully with the value of the measured microscopic observable. This requires that the entanglement is reduced between microscopic and macroscopic systems .

I have identified the "classical" degrees of freedom in TGD framework as zero modes which by definition do not contribute to the line-element of WCW although the WCW metric depends on zero modes as external parameters. The induced Kähler field represents an infinite number of zero modes whereas the Hamiltonians of the boundaries of  $CD$  define quantum fluctuating degrees of freedom.

The reduction of the entanglement between zero modes and quantum fluctuating degrees of freedom is an essential part of quantum measurement process. Also state function reductions between microscopic degrees of freedom are predicted to occur and this kind of reductions lead to decoherence so that one can apply quantum statistical description and derive Boltzmann equations. Also state function reductions between different values of zero modes are possible and one could perhaps assign "telepathic" effects with them.

The differences with respect to the standard quantum measurement theory are that several kinds of state function reductions are possible and that the division to classical and quantum fluctuating degrees of freedom has a purely geometric meaning in TGD framework.

7. One can even imagine quantum parallel state function reduction cascades. This would make possible quantum parallel dissipation, which would be something new. My original proposal was that in hadronic physics this could make possible a state function reduction cascade proceeding in quark scales while hadronic scales would remain entangled so that one could apply statistical description to quarks as parts of a system, which is quantum coherent in hadronic length scale.

This looks nice but...! It is a pity that eventually an objection pops up against every idea irrespective how cute it looks like. The p-adic primes associated with light quarks are larger than that associated with hadron so that quarks - or rather, their magnetic bodies are larger than that hadron's magnetic body. This looks strange at first but actually conforms with Uncertainty Principle and the observation that the charge radius of proton is slightly smaller than predicted (see this, [?]), gives support for this picture. Geometrically the situation might change if quarks are highly relativistic and color magnetic fields of quarks are dipoled fields compressed to cigar like shape: Lorentz contraction could reduce the size scale of their magnetic bodies in the direction of their motion. [Note that p-adic length scale hypothesis applies in the rest system of the particle so that Lorentz contraction is in conflict with it]. Situation remains unsettled.

### Further questions

There are many other interesting issues about which my understanding could be much better.

1. In ZEO the choice of the quantization axes and would fix the moduli of the causal diamond  $CD$ : the preferred time direction defined by the line connecting the tips of  $CD$ , the spin quantization axis, etc.. This choice certainly occurs. Does it reduce to the measurement of a density matrix for some decomposition of some subsystem to a pair? Or should one simply assume state function reductions also at this level meaning localization to a sector of WCW corresponding to given  $CD$ . This would involve localization in the moduli space of  $CD$ s selecting some boost of a  $CD$  with fixed quantized proper time distance between its tips, fixed spin directions for positive and negative energy parts of zero energy states defined by light-like geodesics at its light-like boundary. Preferred complex coordinates for  $CP_2$ , etc...
2. Zero energy states are characterized by arrow of geometric time in the sense that either positive or negative energy parts of states have well defined particles numbers and single particle numbers but not both. State function reduction is possible only for positive or negative energy part of the state but not both. This should relate very closely to the fact that our sensory percepts defined by state function reductions are mostly about the upper or lower boundary of  $CD$ , or to

the fact that we do not remember the percepts made from the other boundary during sleeping period.

3. In ZEO also quantum jumps can also lead to generation of new sub-Universes, sub-CDs carrying zero energy states. Quantum jumps can also involve phase transitions changing p-adic space-time sheets to real ones and these could serve as quantum correlates for intentional actions. Also the reverse process changing matter to thoughts is possible. These possibilities are totally unimaginable in the quantum measurement theory for systems describable by wave mechanics.
4. There is also the notion of finite measurement resolution described in terms of inclusions of hyperfinite factors at quantum level and in terms of braids at space-time level.

To summarize, a lot of theory building is needed in order to fuse all new elements to a coherent framework. In this framework standard quantum measurement theory is only a collection of ad hoc rules and can catch only a small part of what really happens. Certainly, standard quantum measurement theory is far from being enough for the purposes of consciousness theorist.



# Mathematics

- [A1] Gaussian Mersenne. <http://primes.utm.edu/glossary/xpage/GaussianMersenne.html>.
- [A2] Z. I. Borevich and I. R. Shafarevich. *Number Theory*. Academic Press, 1966.
- [A3] Eisenhart. *Riemannian Geometry*. Princeton University Press, 1964.
- [A4] C. N. Pope G. W. Gibbons.  $CP_2$  as gravitational instanton. *Comm. Math. Phys.*, 55, 1977.
- [A5] W. Hawking, S. and N. Pope, C. Generalized Spin Structures in Quantum Gravity. *Phys. Lett.*, (1), 1978.
- [A6] S. Helgason. *Differential Geometry and Symmetric Spaces*. Academic Press, New York, 1962.
- [A7] C. Itzykson and J-B. Zuber. *Quantum Field Theory*, volume 549. Mc Graw-Hill, New York, 1980.
- [A8] J. Milnor. *Topology form Differential Point of View*. The University Press of Virginia, Virginia, 1965.
- [A9] D. S. Moak. The q-analogue of the Laguerre polynomials. *J. Math. Anal. Appl.*, 81, 1981.
- [A10] N. Pope, C. Eigenfunctions and  $Spin^c$  Structures on  $CP_2$ , 1980.
- [A11] B. Shipman. The geometry of momentum mappings on generalized flag manifolds, connections with a dynamical system, quantum mechanics and the dance of honeybee. <http://math.cornell.edu/~oliver/Shipman.gif>, 1998.
- [A12] M. Spivak. *Differential Geometry I,II,III,IV*. Publish or Perish, Boston, 1970.
- [A13] J. Hanson T. Eguchi, B. Gilkey. *Phys. Rep.*, 66:1980, 1980.
- [A14] R. Thom. *Commentarii Math. Helvet.*, 28, 1954.
- [A15] Wallace. *Differential Topology*. W. A. Benjamin, New York, 1968.
- [A16] E. C. Zeeman. *Catastrophe Theory*. Addison-Wessley Publishing Company, 1977.



# Theoretical Physics

- [B1] J. Björken and S. Drell. *Relativistic Quantum Fields*. Mc Graw-Hill, New York, 1965.
- [B2] K. Huang. *Quarks, Leptons & Gauge Fields*. World Scientific, 1982.
- [B3] R. Kiehn. Electromagnetic waves in vacuum with torsion and spin. <http://www22.pair.com/csdc/pdf/helical6.pdf>.
- [B4] G. Parisi. *Field Theory, Disorder and Simulations*. World Scientific, 1992.
- [B5] A. Zee. *The Unity of Forces in the Universe*. World Science Press, Singapore, 1982.





# Neuroscience and Consciousness

- [J1] Visual short term memory. [http://en.wikipedia.org/wiki/Visual\\_short-term\\_memory](http://en.wikipedia.org/wiki/Visual_short-term_memory).
- [J2] Frontal lobes. [http://en.wikipedia.org/wiki/Frontal\\_lobes](http://en.wikipedia.org/wiki/Frontal_lobes).
- [J3] Goldman equation. [http://en.wikipedia.org/wiki/Goldman\\_equation](http://en.wikipedia.org/wiki/Goldman_equation).
- [J4] Limbic system. [http://en.wikipedia.org/wiki/Limbic\\_system](http://en.wikipedia.org/wiki/Limbic_system).
- [J5] A method of changing biological object's hereditary signs and a device for biological information directed transfer. Patent N1828665. Application N3434801, invention priority as of 30.12.1981, registered 13.10.1992.
- [J6] Short term memory. [http://en.wikipedia.org/wiki/Short\\_term\\_memory](http://en.wikipedia.org/wiki/Short_term_memory).
- [J7] D. J. Benor. *Spiritual Healing: scientific validation of a healing revolution Vol. I*. Vision publications, Southfield MI, 2001.
- [J8] D. J. Bierman and D. I. Radin. Anomalous Anticipatory Response on Randomized Future Conditions. *Perceptual and Motor Skills*, 84:689–690, 1997.
- [J9] C. F. Blackman. *Effect of Electrical and Magnetic Fields on the Nervous System*, pages 331–355. Plenum, New York, 1994.
- [J10] V. Chernobrov. Experiments on the Change of Direction and Rate of Time Motion. In *Proc. of III Int. Conf. On Problems of Space, Time, and Gravitation. Russian Academy of Sciences, St. Petersburg, Russia*, 1996.
- [J11] U. Di Corpo. The conflict between entropy and syntropy: the vital needs model. 2007.
- [J12] B. Libet et al. Subjective referral of the timing for a conscious sensory experience. *Brain*, 102, 1979.
- [J13] L. Fantappie. *Teoria Unitaria del Mondo Fisico e Biologico*. Di Renzo Editore, Roma, 1942.
- [J14] M. Germiné. Scientific Validation of Planetary Consciousness. *Journal of Non-Locality and Remote Mental Interactions*. <http://www.emergentmind.org/germineI3.htm>, 1(3), 2002.
- [J15] A. M'Chirgui M. Ben Salem M. Sakly H. Abdelmeik, S. Amara. Impact of evolution on the electrical properties of sciatic nerves: super-conductivity-like. *Journal of Physical & Chemical News*, 2003.
- [J16] S. Klein. Libet's Research on Timing of Conscious Intention to Act: A Commentary. *Consciousness and Cognition*. [http://cornea.berkeley.edu/pubs/ccog\\_2002\\_0580-Klein-Commentary.pdf](http://cornea.berkeley.edu/pubs/ccog_2002_0580-Klein-Commentary.pdf), 11, 2002.
- [J17] B. Libet. Readiness potentials preceding unrestricted spontaneous and preplanned voluntary acts. [http://cornea.berkeley.edu/pubs/ccog\\_2002\\_0580-Klein-Commentary.pdf](http://cornea.berkeley.edu/pubs/ccog_2002_0580-Klein-Commentary.pdf), 1982.
- [J18] J. McMoneagle. *Remote Viewing Secrets*. Hampton Roads Publishing Company, Inc., 2000.
- [J19] Kozyrev N.A. *Prichinnaya ili nesimmetrichnaya mekhanika v lineinom priblizhenii*. GAO AN SSSR, Pulkovo, 1958.

- [J20] P. L. Nunez. Toward a Quantitative Description of Large Scale Neocortical Dynamic Function and EEG. *Behavioral and Brain Sciences*, 23, 2000.
- [J21] M. Persinger. The tectonic strain theory as an explanation for UFO phenomena. <http://www.laurentian.ca/www/neurosci/tectonicedit.htm>, 1999.
- [J22] D. Reed. Conceptual Hurdles to New Millennium Physics. *Explore!*, (1), 2003.
- [J23] J. S. Nicholis S. W. Kuffler and A. R. Martin. *From Neuron to Brain*. Sinauer, Massachusetts, 1984.
- [J24] W. A. Tiller. Towards a Quantitative Science and Technology that Includes Human Consciousness. *Vision-In-Action*. <http://www.via-visioninaction.org>, 4, 2003.
- [J25] W. A. Tiller and W. E. Dibble Jr. New experimental data revealing an unexpected dimension to materials science and engineering. *Mat. Res. Innovat.*, 5:21–34, 2001.
- [J26] W. A. Tiller and W. E. Dibble Jr. Anomalous Temperature Oscillation Behavior Near a Source in a "Conditioned" Space: part I, The Spatial Variation. <http://tillerfoundation.com/newpapers.htm>, 2002.
- [J27] A. Vannini. Advanced Waves, Retrocausality, and Consciousness. 2007.
- [J28] W. E. Dibble Jr. W. A. Tiller and M. J. Kohane. *Conscious Acts of Creation: the Emergence of a New Physics*, volume 17. Pavior Publishing, 2001.
- [J29] L. Day (with G. DelaWarr). *New Worlds Beyond the Atom*. Vincent Stuart Publishers Ltd., London, 1956.

# Books related to TGD

- [K1] M. Pitkänen. 1983.
- [K2] M. Pitkänen. Is it Possible to Understand Coupling Constant Evolution at Space-Time Level? In *Towards M-Matrix*. Onlinebook. [http://tgdtheory.com/public\\_html/tgdquant/tgdquant.html#rgflow](http://tgdtheory.com/public_html/tgdquant/tgdquant.html#rgflow), 2006.
- [K3] M. Pitkänen. About Strange Effects Related to Rotating Magnetic Systems . In *TGD and Fringe Physics*. Onlinebook. [http://tgdtheory.com/public\\_html/freenergy/freenergy.html#Faraday](http://tgdtheory.com/public_html/freenergy/freenergy.html#Faraday), 2006.
- [K4] M. Pitkänen. About the New Physics Behind Qualia. In *Quantum Hardware of Living Matter*. Onlinebook. [http://tgdtheory.com/public\\_html/bioware/bioware.html#newphys](http://tgdtheory.com/public_html/bioware/bioware.html#newphys), 2006.
- [K5] M. Pitkänen. An Overview about Quantum TGD: Part I. In *Topological Geometrodynamics: Overview*. Onlinebook. [http://tgdtheory.com/public\\_html/tgdview/tgdview.html#evoII](http://tgdtheory.com/public_html/tgdview/tgdview.html#evoII), 2006.
- [K6] M. Pitkänen. An Overview about the Evolution of Quantum TGD. In *Topological Geometrodynamics: Overview*. Onlinebook. [http://tgdtheory.com/public\\_html/tgdview/tgdview.html#evoI](http://tgdtheory.com/public_html/tgdview/tgdview.html#evoI), 2006.
- [K7] M. Pitkänen. Anomalies Related to the Classical  $Z^0$  Force and Gravitation. In *TGD and Fringe Physics*. Onlinebook. [http://tgdtheory.com/public\\_html/freenergy/freenergy.html#Zanom](http://tgdtheory.com/public_html/freenergy/freenergy.html#Zanom), 2006.
- [K8] M. Pitkänen. Appendix A: Quantum Groups and Related Structures. In *Towards M-Matrix*. Onlinebook. [http://tgdtheory.com/public\\_html/tgdquant/tgdquant.html#bialgebra](http://tgdtheory.com/public_html/tgdquant/tgdquant.html#bialgebra), 2006.
- [K9] M. Pitkänen. Basic Extremals of Kähler Action. In *Physics in Many-Sheeted Space-Time*. Onlinebook. [http://tgdtheory.com/public\\_html/tgdclass/tgdclass.html#class](http://tgdtheory.com/public_html/tgdclass/tgdclass.html#class), 2006.
- [K10] M. Pitkänen. *Bio-Systems as Conscious Holograms*. Onlinebook. [http://tgdtheory.com/public\\_html/hologram/hologram.html](http://tgdtheory.com/public_html/hologram/hologram.html), 2006.
- [K11] M. Pitkänen. Bio-Systems as Conscious Holograms. In *Bio-Systems as Conscious Holograms*. Onlinebook. [http://tgdtheory.com/public\\_html/hologram/hologram.html#hologram](http://tgdtheory.com/public_html/hologram/hologram.html#hologram), 2006.
- [K12] M. Pitkänen. *Bio-Systems as Self-Organizing Quantum Systems*. Onlinebook. [http://tgdtheory.com/public\\_html/bioselforg/bioselforg.html](http://tgdtheory.com/public_html/bioselforg/bioselforg.html), 2006.
- [K13] M. Pitkänen. Bio-Systems as Super-Conductors: part I. In *Quantum Hardware of Living Matter*. Onlinebook. [http://tgdtheory.com/public\\_html/bioware/bioware.html#superc1](http://tgdtheory.com/public_html/bioware/bioware.html#superc1), 2006.
- [K14] M. Pitkänen. Bio-Systems as Super-Conductors: part II. In *Quantum Hardware of Living Matter*. Onlinebook. [http://tgdtheory.com/public\\_html/bioware/bioware.html#superc2](http://tgdtheory.com/public_html/bioware/bioware.html#superc2), 2006.
- [K15] M. Pitkänen. Configuration Space Spinor Structure. In *Quantum Physics as Infinite-Dimensional Geometry*. Onlinebook. [http://tgdtheory.com/public\\_html/tgdgeom/tgdgeom.html#cspin](http://tgdtheory.com/public_html/tgdgeom/tgdgeom.html#cspin), 2006.

- [K16] M. Pitkänen. Construction of elementary particle vacuum functionals. In *p-Adic Length Scale Hypothesis and Dark Matter Hierarchy*. Onlinebook. [http://tgdtheory.com/public\\_html/paddark/paddark.html#elvafu](http://tgdtheory.com/public_html/paddark/paddark.html#elvafu), 2006.
- [K17] M. Pitkänen. Construction of Quantum Theory: M-matrix. In *Towards M-Matrix*. Onlinebook. [http://tgdtheory.com/public\\_html/tgdquant/tgdquant.html#towards](http://tgdtheory.com/public_html/tgdquant/tgdquant.html#towards), 2006.
- [K18] M. Pitkänen. Cosmic Strings. In *Physics in Many-Sheeted Space-Time*. Onlinebook. [http://tgdtheory.com/public\\_html/tgdclass/tgdclass.html#cstrings](http://tgdtheory.com/public_html/tgdclass/tgdclass.html#cstrings), 2006.
- [K19] M. Pitkänen. Crop Circles and Life at Parallel Space-Time Sheets. In *Magnetospheric Consciousness*. Onlinebook. [http://tgdtheory.com/public\\_html/magnconsc/magnconsc.html#crop1](http://tgdtheory.com/public_html/magnconsc/magnconsc.html#crop1), 2006.
- [K20] M. Pitkänen. Crop Circles and Life at Parallel Space-Time Sheets. In *Magnetospheric Consciousness*. Onlinebook. [http://tgdtheory.com/public\\_html/magnconsc/magnconsc.html#crop2](http://tgdtheory.com/public_html/magnconsc/magnconsc.html#crop2), 2006.
- [K21] M. Pitkänen. Dark Forces and Living Matter. In *p-Adic Length Scale Hypothesis and Dark Matter Hierarchy*. Onlinebook. [http://tgdtheory.com/public\\_html/paddark/paddark.html#darkforces](http://tgdtheory.com/public_html/paddark/paddark.html#darkforces), 2006.
- [K22] M. Pitkänen. Dark Matter Hierarchy and Hierarchy of EEGs. In *TGD and EEG*. Onlinebook. [http://tgdtheory.com/public\\_html/tgdeeg/tgdeeg.html#eegdark](http://tgdtheory.com/public_html/tgdeeg/tgdeeg.html#eegdark), 2006.
- [K23] M. Pitkänen. Dark Nuclear Physics and Condensed Matter. In *p-Adic Length Scale Hypothesis and Dark Matter Hierarchy*. Onlinebook. [http://tgdtheory.com/public\\_html/paddark/paddark.html#exonuclear](http://tgdtheory.com/public_html/paddark/paddark.html#exonuclear), 2006.
- [K24] M. Pitkänen. DNA as Topological Quantum Computer. In *Genes and Memes*. Onlinebook. [http://tgdtheory.com/public\\_html/genememe/genememe.html#dnatqc](http://tgdtheory.com/public_html/genememe/genememe.html#dnatqc), 2006.
- [K25] M. Pitkänen. Does TGD Predict the Spectrum of Planck Constants? In *Towards M-Matrix*. Onlinebook. [http://tgdtheory.com/public\\_html/tgdquant/tgdquant.html#Planck](http://tgdtheory.com/public_html/tgdquant/tgdquant.html#Planck), 2006.
- [K26] M. Pitkänen. Evolution in Many-Sheeted Space-Time. In *Genes and Memes*. Onlinebook. [http://tgdtheory.com/public\\_html/genememe/genememe.html#prebio](http://tgdtheory.com/public_html/genememe/genememe.html#prebio), 2006.
- [K27] M. Pitkänen. General Ideas about Many-Sheeted Space-Time: Part I. In *Physics in Many-Sheeted Space-Time*. Onlinebook. [http://tgdtheory.com/public\\_html/tgdclass/tgdclass.html#topcond](http://tgdtheory.com/public_html/tgdclass/tgdclass.html#topcond), 2006.
- [K28] M. Pitkänen. General Theory of Qualia. In *Bio-Systems as Conscious Holograms*. Onlinebook. [http://tgdtheory.com/public\\_html/hologram/hologram.html#qualia](http://tgdtheory.com/public_html/hologram/hologram.html#qualia), 2006.
- [K29] M. Pitkänen. *Genes and Memes*. Onlinebook. [http://tgdtheory.com/public\\_html/genememe/genememe.html](http://tgdtheory.com/public_html/genememe/genememe.html), 2006.
- [K30] M. Pitkänen. Genes and Memes. In *Genes and Memes*. Onlinebook. [http://tgdtheory.com/public\\_html/genememe/genememe.html#genememec](http://tgdtheory.com/public_html/genememe/genememe.html#genememec), 2006.
- [K31] M. Pitkänen. Homeopathy in Many-Sheeted Space-Time. In *Bio-Systems as Conscious Holograms*. Onlinebook. [http://tgdtheory.com/public\\_html/hologram/hologram.html#homeoc](http://tgdtheory.com/public_html/hologram/hologram.html#homeoc), 2006.
- [K32] M. Pitkänen. Macro-Temporal Quantum Coherence and Spin Glass Degeneracy. In *Bio-Systems as Conscious Holograms*. Onlinebook. [http://tgdtheory.com/public\\_html/hologram/hologram.html#macro](http://tgdtheory.com/public_html/hologram/hologram.html#macro), 2006.
- [K33] M. Pitkänen. Macroscopic Quantum Coherence and Quantum Metabolism as Different Sides of the Same Coin. In *Bio-Systems as Conscious Holograms*. Onlinebook. [http://tgdtheory.com/public\\_html/hologram/hologram.html#metab](http://tgdtheory.com/public_html/hologram/hologram.html#metab), 2006.

- [K34] M. Pitkänen. Macroscopic Quantum Phenomena and  $CP_2$  Geometry. In *Physics in Many-Sheeted Space-Time*. Onlinebook. [http://tgdtheory.com/public\\_html/tgdclass/tgdclass.html#super](http://tgdtheory.com/public_html/tgdclass/tgdclass.html#super), 2006.
- [K35] M. Pitkänen. Magnetic Sensory Canvas Hypothesis. In *TGD and EEG*. Onlinebook. [http://tgdtheory.com/public\\_html//tgdeeg/tgdeeg/tgdeeg.html#mec](http://tgdtheory.com/public_html//tgdeeg/tgdeeg/tgdeeg.html#mec), 2006.
- [K36] M. Pitkänen. *Magnetospheric Consciousness*. Onlinebook. [http://tgdtheory.com/public\\_html/magnconsc/magnconsc.html](http://tgdtheory.com/public_html/magnconsc/magnconsc.html), 2006.
- [K37] M. Pitkänen. Magnetospheric Sensory Representations. In *Magnetospheric Consciousness*. Onlinebook. [http://tgdtheory.com/public\\_html/magnconsc/magnconsc.html#srepress](http://tgdtheory.com/public_html/magnconsc/magnconsc.html#srepress), 2006.
- [K38] M. Pitkänen. Many-Sheeted DNA. In *Genes and Memes*. Onlinebook. [http://tgdtheory.com/public\\_html/genememe/genememe.html#genecodec](http://tgdtheory.com/public_html/genememe/genememe.html#genecodec), 2006.
- [K39] M. Pitkänen. Massless states and particle massivation. In *p-Adic Length Scale Hypothesis and Dark Matter Hierarchy*. Onlinebook. [http://tgdtheory.com/public\\_html/paddark/paddark.html#mless](http://tgdtheory.com/public_html/paddark/paddark.html#mless), 2006.
- [K40] M. Pitkänen. *Mathematical Aspects of Consciousness Theory*. Onlinebook. [http://tgdtheory.com/public\\_html/mathconsc/mathconsc.html](http://tgdtheory.com/public_html/mathconsc/mathconsc.html), 2006.
- [K41] M. Pitkänen. Matter, Mind, Quantum. In *TGD Inspired Theory of Consciousness*. Onlinebook. [http://tgdtheory.com/public\\_html/tgdconsc/tgdconsc.html#conscic](http://tgdtheory.com/public_html/tgdconsc/tgdconsc.html#conscic), 2006.
- [K42] M. Pitkänen. Negentropy Maximization Principle. In *TGD Inspired Theory of Consciousness*. Onlinebook. [http://tgdtheory.com/public\\_html/tgdconsc/tgdconsc.html#nmpc](http://tgdtheory.com/public_html/tgdconsc/tgdconsc.html#nmpc), 2006.
- [K43] M. Pitkänen. New Particle Physics Predicted by TGD: Part I. In *p-Adic Length Scale Hypothesis and Dark Matter Hierarchy*. Onlinebook. [http://tgdtheory.com/public\\_html/paddark/paddark.html#mass4](http://tgdtheory.com/public_html/paddark/paddark.html#mass4), 2006.
- [K44] M. Pitkänen. Nuclear String Hypothesis. In *p-Adic Length Scale Hypothesis and Dark Matter Hierarchy*. Onlinebook. [http://tgdtheory.com/public\\_html/paddark/paddark.html#nuclstring](http://tgdtheory.com/public_html/paddark/paddark.html#nuclstring), 2006.
- [K45] M. Pitkänen. *p-Adic length Scale Hypothesis and Dark Matter Hierarchy*. Onlinebook. [http://tgdtheory.com/public\\_html/paddark/paddark.html](http://tgdtheory.com/public_html/paddark/paddark.html), 2006.
- [K46] M. Pitkänen. p-Adic Particle Massivation: Hadron Masses. In *p-Adic Length Scale Hypothesis and Dark Matter Hierarchy*. Onlinebook. [http://tgdtheory.com/public\\_html/paddark/paddark.html#mass3](http://tgdtheory.com/public_html/paddark/paddark.html#mass3), 2006.
- [K47] M. Pitkänen. p-Adic Physics as Physics of Cognition and Intention. In *TGD Inspired Theory of Consciousness*. Onlinebook. [http://tgdtheory.com/public\\_html/tgdconsc/tgdconsc.html#cognic](http://tgdtheory.com/public_html/tgdconsc/tgdconsc.html#cognic), 2006.
- [K48] M. Pitkänen. *Physics in Many-Sheeted Space-Time*. Onlinebook. [http://tgdtheory.com/public\\_html/tgdclass/tgdclass.html](http://tgdtheory.com/public_html/tgdclass/tgdclass.html), 2006.
- [K49] M. Pitkänen. Quantum Antenna Hypothesis. In *Quantum Hardware of Living Matter*. Onlinebook. [http://tgdtheory.com/public\\_html/bioware/bioware.html#tubuc](http://tgdtheory.com/public_html/bioware/bioware.html#tubuc), 2006.
- [K50] M. Pitkänen. Quantum Astrophysics. In *Physics in Many-Sheeted Space-Time*. Onlinebook. [http://tgdtheory.com/public\\_html/tgdclass/tgdclass.html#qastro](http://tgdtheory.com/public_html/tgdclass/tgdclass.html#qastro), 2006.
- [K51] M. Pitkänen. Quantum Control and Coordination in Bio-systems: Part I. In *Bio-Systems as Self-Organizing Quantum Systems*. Onlinebook. [http://tgdtheory.com/public\\_html/bioselforg/bioselforg.html#qcococI](http://tgdtheory.com/public_html/bioselforg/bioselforg.html#qcococI), 2006.
- [K52] M. Pitkänen. Quantum Control and Coordination in Bio-Systems: Part II. In *Bio-Systems as Self-Organizing Quantum Systems*. Onlinebook. [http://tgdtheory.com/public\\_html/bioselforg/bioselforg.html#qcococII](http://tgdtheory.com/public_html/bioselforg/bioselforg.html#qcococII), 2006.

- [K53] M. Pitkänen. *Quantum Hardware of Living Matter*. Onlinebook. [http://tgdtheory.com/public\\_html/bioware/bioware.html](http://tgdtheory.com/public_html/bioware/bioware.html), 2006.
- [K54] M. Pitkänen. Quantum Model for Hearing. In *TGD and EEG*. Onlinebook. [http://tgdtheory.com/public\\_html//tgdeeg/tgdeeg/tgdeeg.html#hearing](http://tgdtheory.com/public_html//tgdeeg/tgdeeg/tgdeeg.html#hearing), 2006.
- [K55] M. Pitkänen. Quantum Model for Nerve Pulse. In *TGD and EEG*. Onlinebook. [http://tgdtheory.com/public\\_html//tgdeeg/tgdeeg/tgdeeg.html#pulse](http://tgdtheory.com/public_html//tgdeeg/tgdeeg/tgdeeg.html#pulse), 2006.
- [K56] M. Pitkänen. Quantum Model for Paranormal Phenomena. In *TGD Inspired Theory of Consciousness*. Onlinebook. [http://tgdtheory.com/public\\_html/tgdconsc/tgdconsc.html#parac](http://tgdtheory.com/public_html/tgdconsc/tgdconsc.html#parac), 2006.
- [K57] M. Pitkänen. Quantum Model for Sensory Representations. In *TGD Inspired Theory of Consciousness*. Onlinebook. [http://tgdtheory.com/public\\_html/tgdconsc/tgdconsc.html#expc](http://tgdtheory.com/public_html/tgdconsc/tgdconsc.html#expc), 2006.
- [K58] M. Pitkänen. Quantum Model of EEG. In *TGD and EEG*. Onlinebook. [http://tgdtheory.com/public\\_html/tgdeeg/tgdeeg.html#eegII](http://tgdtheory.com/public_html/tgdeeg/tgdeeg.html#eegII), 2006.
- [K59] M. Pitkänen. Quantum Model of Memory. In *TGD Inspired Theory of Consciousness*. Onlinebook. [http://tgdtheory.com/public\\_html/tgdconsc/tgdconsc.html#memoryc](http://tgdtheory.com/public_html/tgdconsc/tgdconsc.html#memoryc), 2006.
- [K60] M. Pitkänen. *Quantum Physics as Infinite-Dimensional Geometry*. Onlinebook. [http://tgdtheory.com/public\\_html/tgdgeom/tgdgeom.html](http://tgdtheory.com/public_html/tgdgeom/tgdgeom.html), 2006.
- [K61] M. Pitkänen. *Quantum TGD*. Onlinebook. [http://tgdtheory.com/public\\_html/tgdquant/tgdquant.html](http://tgdtheory.com/public_html/tgdquant/tgdquant.html), 2006.
- [K62] M. Pitkänen. Quantum Theory of Self-Organization. In *Bio-Systems as Self-Organizing Quantum Systems*. Onlinebook. [http://tgdtheory.com/public\\_html/bioselforg/bioselforg.html#selforgac](http://tgdtheory.com/public_html/bioselforg/bioselforg.html#selforgac), 2006.
- [K63] M. Pitkänen. Semi-trance, Mental Illness, and Altered States of Consciousness. In *Magnetospheric Consciousness*. Onlinebook. [http://tgdtheory.com/public\\_html/magnconsc/magnconsc.html#semitrancec](http://tgdtheory.com/public_html/magnconsc/magnconsc.html#semitrancec), 2006.
- [K64] M. Pitkänen. Semitrance, Language, and Development of Civilization. In *Magnetospheric Consciousness*. Onlinebook. [http://tgdtheory.com/public\\_html/magnconsc/magnconsc.html#langsoc](http://tgdtheory.com/public_html/magnconsc/magnconsc.html#langsoc), 2006.
- [K65] M. Pitkänen. TGD and Astrophysics. In *Physics in Many-Sheeted Space-Time*. Onlinebook. [http://tgdtheory.com/public\\_html/tgdclass/tgdclass.html#astro](http://tgdtheory.com/public_html/tgdclass/tgdclass.html#astro), 2006.
- [K66] M. Pitkänen. TGD and Cosmology. In *Physics in Many-Sheeted Space-Time*. Onlinebook. [http://tgdtheory.com/public\\_html/tgdclass/tgdclass.html#cosmo](http://tgdtheory.com/public_html/tgdclass/tgdclass.html#cosmo), 2006.
- [K67] M. Pitkänen. *TGD and EEG*. Onlinebook. [http://tgdtheory.com/public\\_html/tgdeeg/tgdeeg.html](http://tgdtheory.com/public_html/tgdeeg/tgdeeg.html), 2006.
- [K68] M. Pitkänen. *TGD and Fringe Physics*. Onlinebook. [http://tgdtheory.com/public\\_html/freenergy/freenergy.html](http://tgdtheory.com/public_html/freenergy/freenergy.html), 2006.
- [K69] M. Pitkänen. TGD and Nuclear Physics. In *p-Adic Length Scale Hypothesis and Dark Matter Hierarchy*. Onlinebook. [http://tgdtheory.com/public\\_html/paddark/paddark.html#padnucl](http://tgdtheory.com/public_html/paddark/paddark.html#padnucl), 2006.
- [K70] M. Pitkänen. *TGD as a Generalized Number Theory*. Onlinebook. [http://tgdtheory.com/public\\_html/tgdnumber/tgdnumber.html](http://tgdtheory.com/public_html/tgdnumber/tgdnumber.html), 2006.
- [K71] M. Pitkänen. TGD as a Generalized Number Theory: p-Adicization Program. In *TGD as a Generalized Number Theory*. Onlinebook. [http://tgdtheory.com/public\\_html/tgdnumber/tgdnumber.html#visiona](http://tgdtheory.com/public_html/tgdnumber/tgdnumber.html#visiona), 2006.

- [K72] M. Pitkänen. TGD as a Generalized Number Theory: Quaternions, Octonions, and their Hyper Counterparts. In *TGD as a Generalized Number Theory*. Onlinebook. [http://tgdtheory.com/public\\_html/tgdnumber/tgdnumber.html#visionb](http://tgdtheory.com/public_html/tgdnumber/tgdnumber.html#visionb), 2006.
- [K73] M. Pitkänen. TGD Based Model for OBEs. In *TGD Inspired Theory of Consciousness*. Onlinebook. [http://tgdtheory.com/public\\_html/tgdconsc/tgdconsc.html#OBE](http://tgdtheory.com/public_html/tgdconsc/tgdconsc.html#OBE), 2006.
- [K74] M. Pitkänen. *TGD Inspired Theory of Consciousness*. Onlinebook. [http://tgdtheory.com/public\\_html/tgdconsc/tgdconsc.html](http://tgdtheory.com/public_html/tgdconsc/tgdconsc.html), 2006.
- [K75] M. Pitkänen. TGD Inspired Theory of Consciousness. In *Topological Geometrodynamics: Overview*. Onlinebook. [http://tgdtheory.com/public\\_html/tgdview/tgdview.html#tgdconsc2010](http://tgdtheory.com/public_html/tgdview/tgdview.html#tgdconsc2010), 2006.
- [K76] M. Pitkänen. The Notion of Free Energy and Many-Sheeted Space-Time Concept. In *TGD and Fringe Physics*. Onlinebook. [http://tgdtheory.com/public\\_html/freenergy/freenergy.html#freenergy](http://tgdtheory.com/public_html/freenergy/freenergy.html#freenergy), 2006.
- [K77] M. Pitkänen. The Relationship Between TGD and GRT. In *Physics in Many-Sheeted Space-Time*. Onlinebook. [http://tgdtheory.com/public\\_html/tgdclass/tgdclass.html#tgdgrt](http://tgdtheory.com/public_html/tgdclass/tgdclass.html#tgdgrt), 2006.
- [K78] M. Pitkänen. Three new physics realizations of the genetic code and the role of dark matter in bio-systems. In *Genes and Memes*. Onlinebook. [http://tgdtheory.com/public\\_html/genememe/genememe.html#dnatqccodes](http://tgdtheory.com/public_html/genememe/genememe.html#dnatqccodes), 2006.
- [K79] M. Pitkänen. Time, Spacetime and Consciousness. In *Bio-Systems as Conscious Holograms*. Onlinebook. [http://tgdtheory.com/public\\_html/hologram/hologram.html#time](http://tgdtheory.com/public_html/hologram/hologram.html#time), 2006.
- [K80] M. Pitkänen. *Topological Geometrodynamics: an Overview*. Onlinebook. [http://tgdtheory.com/public\\_html/tgdview/tgdview.html](http://tgdtheory.com/public_html/tgdview/tgdview.html), 2006.
- [K81] M. Pitkänen. Topological Quantum Computation in TGD Universe. In *Genes and Memes*. Onlinebook. [http://tgdtheory.com/public\\_html/genememe/genememe.html#tqc](http://tgdtheory.com/public_html/genememe/genememe.html#tqc), 2006.
- [K82] M. Pitkänen. Was von Neumann Right After All. In *Towards M-Matrix*. Onlinebook. [http://tgdtheory.com/public\\_html/tgdquant/tgdquant.html#vNeumann](http://tgdtheory.com/public_html/tgdquant/tgdquant.html#vNeumann), 2006.
- [K83] M. Pitkänen. Wormhole Magnetic Fields. In *Quantum Hardware of Living Matter*. Onlinebook. [http://tgdtheory.com/public\\_html/bioware/bioware.html#wormc](http://tgdtheory.com/public_html/bioware/bioware.html#wormc), 2006.





# Articles about TGD

- [L1] M. Pitkänen. Macro-temporal quantum coherence, quantum spin glass degeneracy, and number theoretic information concept. <http://www.emergentmind.org/journal.htm>, 2003.
- [L2] M. Pitkänen. Time, Space-Time, and Consciousness. <http://www.emergentmind.org/journal.htm>, 2003.
- [L3] M. Pitkänen. Further Progress in Nuclear String Hypothesis. <http://tgdtheory.com/articles/nuclstring.pdf>, 2007.
- [L4] M. Pitkänen. TGD based solution of Fermi paradox. <http://www.physics.helsinki.fi/~matpitka/articles/fermieng.pdf>, 2007.



## Chapter 7

# Category Theory and Quantum TGD

### 7.1 Introduction

TGD predicts several hierarchical structures involving a lot of new physics. These structures look frustratingly complex and category theoretical thinking might help to build a bird's eye view about the situation. I have already earlier considered the question how category theory might be applied in TGD [K17, ?] . Besides the far from complete understanding of the basic mathematical structure of TGD also my own limited understanding of category theoretical ideas have been a serious limitation. During last years considerable progress in the understanding of quantum TGD proper has taken place and the recent formulation of TGD is in terms of light-like 3-surfaces, zero energy ontology and number theoretic braids [?, K79] . There exist also rather detailed formulations for the fusion of p-adic and real physics and for the dark matter hierarchy. This motivates a fresh look to how category theory might help to understand quantum TGD.

The fusion rules for the symplectic variant of conformal field theory, whose existence is strongly suggested by quantum TGD, allow rather precise description using the basic notions of category theory and one can identify a series of finite-dimensional nilpotent algebras as discretized versions of field algebras defined by the fusion rules. These primitive fusion algebras can be used to construct more complex algebras by replacing any algebra element by a primitive fusion algebra. Trees with arbitrary numbers of branches in any node characterize the resulting collection of fusion algebras forming an operad. One can say that an exact solution of symplectic scalar field theory is obtained.

Conformal fields and symplectic scalar field can be combined to form symplecto-formal fields. The combination of symplectic operad and Feynman graph operad leads to a construction of Feynman diagrams in terms of n-point functions of conformal field theory. M-matrix elements with a finite measurement resolution are expressed in terms of a hierarchy of symplecto-conformal n-point functions such that the improvement of measurement resolution corresponds to an algebra homomorphism mapping conformal fields in given resolution to composite conformal fields in improved resolution. This expresses the idea that composites behave as independent conformal fields. Also other applications are briefly discussed.

### 7.2 S-matrix as a functor

John Baez's [?] discusses in a physicist friendly manner the possible application of category theory to physics. The lessons obtained from the construction of topological quantum field theories (TQFTs) suggest that category theoretical thinking might be very useful in attempts to construct theories of quantum gravitation.

The point is that the Hilbert spaces associated with the initial and final state n-1-manifold of n-cobordism indeed form in a natural manner category. Morphisms of Hilb in turn are unitary or possibly more general maps between Hilbert spaces. TQFT itself is a functor assigning to a cobordism the counterpart of S-matrix between the Hilbert spaces associated with the initial and final n-1-manifold.

The surprising result is that for  $n \leq 4$  the S-matrix can be unitary S-matrix only if the cobordism is trivial. This should lead even string theorist to raise some worried questions.

In the hope of feeding some category theoretic thinking into my spine, I briefly summarize some of the category theoretical ideas discussed in the article and relate it to the TGD vision, and after that discuss the worried questions from TGD perspective. That space-time makes sense only relative to imbedding space would conform with category theoretic thinking.

### 7.2.1 The \*-category of Hilbert spaces

Baez considers first the category of Hilbert spaces. Intuitively the definition of this category looks obvious: take linear spaces as objects in category Set, introduce inner product as additional structure and identify morphisms as maps preserving this inner product. In finite-D case the category with inner product is however identical to the linear category so that the inner product does not seem to be absolutely essential. Baez argues that in infinite-D case the morphisms need not be restricted to unitary transformations: one can consider also bounded linear operators as morphisms since they play key role in quantum theory (consider only observables as Hermitian operators). For hyper-finite factors of type  $II_1$  inclusions define very important morphisms which are not unitary transformations but very similar to them. This challenges the belief about the fundamental role of unitarity and raises the question about how to weaken the unitarity condition without losing everything.

The existence of the inner product is essential only for the metric topology of the Hilbert space. Can one do without inner product as an inherent property of state space and reduce it to a morphism? One can indeed express inner product in terms of morphisms from complex numbers to Hilbert space and their conjugates. For any state  $\Psi$  of Hilbert space there is a unique morphisms  $T_\Psi$  from  $\mathbb{C}$  to Hilbert space satisfying  $T_\Psi(1) = \Psi$ . If one assumes that these morphisms have conjugates  $T_\Psi^*$  mapping Hilbert space to  $\mathbb{C}$ , inner products can be defined as morphisms  $T_\Psi^* T_\Psi$ . The Hermitian conjugates of operators can be defined with respect to this inner product so that one obtains \*-category. Reader has probably realized that  $T_\Psi$  and its conjugate correspond to ket and bra in Dirac's formalism.

Note that in TGD framework based on hyper-finite factors of type  $II_1$  (HFFs) the inclusions of complex rays might be replaced with inclusions of HFFs with included factor representing the finite measurement resolution. Note also the analogy of inner product with the representation of space-times as 4-surfaces of the imbedding space in TGD.

### 7.2.2 The monoidal \*-category of Hilbert spaces and its counterpart at the level of nCob

One can give the category of Hilbert spaces a structure of monoid by introducing explicitly the tensor products of Hilbert spaces. The interpretation is obvious for physicist. Baez describes the details of this identification, which are far from trivial and in the theory of quantum groups very interesting things happen. A non-commutative quantum version of the tensor product implying braiding is possible and associativity condition leads to the celebrated Yang-Baxter equations: inclusions of HFFs lead to quantum groups too.

At the level of nCob the counterpart of the tensor product is disjoint union of n-1-manifolds. This unavoidably creates the feeling of cosmic loneliness. Am I really a disjoint 3-surface in emptiness which is not vacuum even in the geometric sense? Cannot be true!

This horrifying sensation disappears if n-1-manifolds are n-1-surfaces in some higher-dimensional imbedding space so that there would be at least something between them. I can emit a little baby manifold moving somewhere perhaps being received by some-one somewhere and I can receive radiation from some-one at some distance and in some direction as small baby manifolds making gentle tosses on my face!

This consoling feeling could be seen as one of the deep justifications for identifying fundamental objects as light-like partonic 3-surfaces in TGD framework. Their ends correspond to 2-D partonic surfaces at the boundaries of future or past directed light-cones (states of positive and negative energy respectively) and are indeed disjoint but not in the desperately existential sense as 3-geometries of General Relativity.

This disjointness has also positive aspect in TGD framework. One can identify the color degrees of freedom of partons as those associated with  $CP_2$  degrees of freedom. For instance,  $SU(3)$  analogs for rotational states of rigid body become possible. 4-D space-time surfaces as preferred extremals

of Kähler action connect the partonic 3-surfaces and bring in classical representation of correlations and thus of interactions. The representation as sub-manifolds makes it also possible to speak about positions of these sub-Universes and about distances between them. The habitants of TGD Universe are maximally free but not completely alone.

### 7.2.3 TQFT as a functor

The category theoretic formulation of TQFT relies on a very elegant and general idea. Quantum transition has as a space-time correlate an  $n$ -dimensional surface having initial final states as its  $n-1$ -dimensional ends. One assigns Hilbert spaces of states to the ends and S-matrix would be a unitary morphism between the ends. This is expressed in terms of the category theoretic language by introducing the category  $n\text{Cob}$  with objects identified as  $n-1$ -manifolds and morphisms as cobordisms and  $*$ -category  $\text{Hilb}$  consisting of Hilbert spaces with inner product and morphisms which are bounded linear operators which do not however preserve the unitarity. Note that the morphisms of  $n\text{Cob}$  cannot anymore be identified as maps between  $n-1$ -manifolds interpreted as sets with additional structure so that in this case category theory is more powerful than set theory.

TQFT is identified as a functor  $n\text{Cob} \rightarrow \text{Hilb}$  assigning to  $n-1$ -manifolds Hilbert spaces, and to cobordisms unitary S-matrices in the category  $\text{Hilb}$ . This looks nice but the surprise is that for  $n \leq 4$  unitary S-matrix exists only if the cobordism is trivial so that topology changing transitions are not possible unless one gives up unitarity.

This raises several worried questions.

1. Does this result mean that in TQFT sense unitary S-matrix for topology changing transitions from a state containing  $n_i$  closed strings to a state containing  $n_f \neq n_i$  strings does not exist? Could the situation be same also for more general non-topological stringy S-matrices? Could the non-converging perturbation series for S-matrix with finite individual terms matrix fail to no non-perturbative counterpart? Could it be that M-theory is doomed to remain a dream with no hope of being fulfilled?
2. Should one give up the unitarity condition and require that the theory predicts only the relative probabilities of transitions rather than absolute rates? What the proper generalization of the S-matrix could be?
3. What is the relevance of this result for quantum TGD?

### 7.2.4 The situation is in TGD framework

The result about the non-existence of unitary S-matrix for topology changing cobordisms allows new insights about the meaning of the departures of TGD from string models.

#### Cobordism cannot give interesting selection rules

When I started to work with TGD for more than 28 years ago, one of the first ideas was that one could identify the selection rules of quantum transitions as topological selection rules for cobordisms. Within week or two came the great disappointment: there were practically no selection rules. Could one revive this naive idea? Could the existence of unitary S-matrix force the topological selection rules after all? I am skeptic. If I have understood correctly the discussion of what happens in 4-D case [?] only the exotic diffeo-structures modify the situation in 4-D case.

#### Light-like 3-surfaces allow cobordism

In the physically interesting GRT like situation one would expect the cobordism to be mediated by a space-time surface possessing Lorentz signature. This brings in metric and temporal distance. This means complications since one must leave the pure TQFT context. Also the classical dynamics of quantum gravitation brings in strong selection rules related to the dynamics in metric degrees of freedom so that TQFT approach is not expected to be useful from the point of view of quantum gravity and certainly not the limit of a realistic theory of quantum gravitation.

In TGD framework situation is different. 4-D space-time sheets can have Euclidian signature of the induced metric so that Lorentz signature does not pose conditions. The counterparts of cobordisms

correspond at fundamental level to light-like 3-surfaces, which are arbitrarily except for the light-likeness condition (the effective 2-dimensionality implies generalized conformal invariance and analogy with 3-D black-holes since 3-D vacuum Einstein equations are satisfied). Field equations defined by the Chern-Simons action imply that  $CP_2$  projection is at most 2-D but this condition holds true only for the extremals and one has functional integral over all light-like 3-surfaces. The temporal distance between points along light-like 3-surface vanishes. The constraints from light-likeness bring in metric degrees of freedom but in a very gentle manner and just to make the theory physically interesting.

### Feynmann cobordism as opposed to ordinary cobordism

In string model context the discouraging results from TQFT hold true in the category of  $n\text{Cob}$ , which corresponds to trouser diagrams for closed strings or for their open string counterparts. In TGD framework these diagrams are replaced with a direct generalization of Feynman diagrams for which 3-D light-like partonic 3-surfaces meet along their 2-D ends at the vertices. In honor of Feynman one could perhaps speak of Feynman cobordisms. These surfaces are singular as 3-manifolds but vertices are nice 2-manifolds. In contrast to this, in string models diagrams are nice 2-manifolds but vertices are singular as 1-manifolds (say eye-glass type configurations for closed strings).

This picture gains a strong support for the interpretation of fermions as light-like throats associated with connected sums of  $CP_2$  type extremals with space-time sheets with Minkowski signature and of bosons as pairs of light-like wormhole throats associated with  $CP_2$  type extremal connecting two space-time sheets with Minkowski signature of induced metric. The space-time sheets have opposite time orientations so that also zero energy ontology emerges unavoidably. There is also consistency TGD based explanation of the family replication phenomenon in terms of genus of light-like partonic 2-surfaces.

One can wonder what the 4-D space-time sheets associated with the generalized Feynman diagrams could look like? One can try to gain some idea about this by trying to assign 2-D surfaces to ordinary Feynman diagrams having a subset of lines as boundaries. In the case of  $2 \rightarrow 2$  reaction open string is pinched to a point at vertex.  $1 \rightarrow 2$  vertex, and quite generally, vertices with odd number of lines, are impossible. The reason is that 1-D manifolds of finite size can have either 0 or 2 ends whereas in higher-D the number of boundary components is arbitrary. What one expects to happen in TGD context is that wormhole throats which are at distance characterized by  $CP_2$  fuse together in the vertex so that some kind of pinches appear also now.

### Zero energy ontology

Zero energy ontology gives rise to a second profound distinction between TGD and standard QFT. Physical states are identified as states with vanishing net quantum numbers, in particular energy. Everything is creatable from vacuum - and one could add- by intentional action so that zero energy ontology is profoundly Eastern. Positive *resp.* negative energy parts of states can be identified as states associated with 2-D partonic surfaces at the boundaries of future *resp.* past directed light-cones, whose tips correspond to the arguments of  $n$ -point functions. Each incoming/outgoing particle would define a mini-cosmology corresponding to not so big bang/crunch. If the time scale of perception is much shorter than time interval between positive and zero energy states, the ontology looks like the Western positive energy ontology. Bras and kets correspond naturally to the positive and negative energy states and phase conjugation for laser photons making them indeed something which seems to travel in opposite time direction is counterpart for bra-ket duality.

The new element would be quantum measurements performed separately for observables assignable to positive and negative energy states. These measurements would be characterized in terms of Jones inclusions. The state function reduction for the negative energy states could be interpreted as a detection of a particle reaction.

### Finite temperature S-matrix defines genuine quantum state in zero energy ontology

In TGD framework one encounters two S-matrix like operators.

1. There is U-matrix between zero energy states. This is expected to be rather trivial but very important from the point of view of description of intentional actions as transitions transforming p-adic partonic 3-surfaces to their real counterparts.

2. The S-matrix like operator describing what happens in laboratory corresponds to the time-like entanglement coefficients between positive and negative energy parts of the state. Measurement of reaction rates would be a measurement of observables reducing time like entanglement and very much analogous to an ordinary quantum measurement reducing space-like entanglement. There is a finite measurement resolution described by inclusion of HFFs and this means that situation reduces effectively to a finite-dimensional one.

p-Adic thermodynamics strengthened with p-adic length scale hypothesis predicts particle masses with an amazing success. At first the thermodynamical approach seems to be in contradiction with the idea that elementary particles are quantal objects. Unitarity is however *not* necessary if one accepts that only relative probabilities for reductions to pairs of initial and final states interpreted as particle reactions can be measured.

The beneficial implications of unitarity are not lost if one replaces QFT with thermal QFT. Category theoretically this would mean that the time-like entanglement matrix associated with the product of cobordisms is a product of these matrices for the factors. The time parameter in S-matrix would be replaced with a complex time parameter with the imaginary part identified as inverse temperature. Hence the interpretation in terms of time evolution is not lost.

In the theory of hyper-finite factors of type  $III_1$  the partition function for thermal equilibrium states and S-matrix can be neatly fused to a thermal S-matrix for zero energy states and one could introduce p-adic thermodynamics at the level of quantum states. It seems that this picture applies to HFFs by restriction. Therefore the loss of unitarity S-matrix might after all turn to a victory by more or less forcing both zero energy ontology and p-adic thermodynamics. Note that also the presence of factor of type I coming from imbedding space degrees of freedom forces thermal S-matrix.

### Time-like entanglement coefficients as a square root of density matrix?

All quantum states do not correspond to thermal states and one can wonder what might be the most general identification of the quantum state in zero energy ontology. Density matrix formalism defines a very general formulation of quantum theory. Since the quantum states in zero energy ontology are analogous to operators, the idea that time-like entanglement coefficients in some sense define a square root of density matrix is rather natural. This would give the defining conditions

$$\begin{aligned} \rho^+ &= SS^\dagger, \rho^- = S^\dagger S, \\ \text{Tr}(\rho^\pm) &= 1. \end{aligned} \tag{7.2.1}$$

$\rho^\pm$  would define density matrix for positive/negative energy states. In the case HFFs of type  $II_1$  one obtains unitary S-matrix and also the analogs of pure quantum states are possible for factors of type I. The numbers  $p_{m,n}^+ = |S_{m,n}^2|/\rho_{m,m}^+$  and  $p_{m,n}^- = |S_{n,m}^2|/\rho_{m,m}^-$  give the counterparts of the usual scattering probabilities.

A physically well-motivated hypothesis would be that  $S$  has expression  $S = \sqrt{\rho}S_0$  such that  $S_0$  is a universal unitary S-matrix, and  $\sqrt{\rho}$  is square root of a state dependent density matrix. Note that in general  $S$  is not diagonalizable in the algebraic extension involved so that it is not possible to reduce the scattering to a mere phase change by a suitable choice of state basis.

What makes this kind of hypothesis aesthetically attractive is the unification of two fundamental matrices of quantum theory to single one. This unification is completely analogous to the combination of modulus squared and phase of complex number to a single complex number: complex valued Schrödinger amplitude is replaced with operator valued one.

### S-matrix as a functor and the groupoid structure formed by S-matrices

In zero energy ontology S-matrix can be seen as a functor from the category of Feynman cobordisms to the category of operators. S-matrix can be identified as a "square root" of the positive energy density matrix  $S = \rho_+^{1/2}S_0$ , where  $S_0$  is a unitary matrix and  $\rho_+$  is the density matrix for positive energy part of the zero energy state. Obviously one has  $SS^\dagger = \rho_+$ .  $S^\dagger S = \rho_-$  gives the density matrix for negative energy part of zero energy state. Clearly, S-matrix can be seen as matrix valued generalization of Schrödinger amplitude. Note that the "indices" of the S-matrices correspond to configuration space spinors (fermions and their bound states giving rise to gauge bosons and gravitons)

and to configuration space degrees of freedom (world of classical worlds). For hyper-finite factor of  $II_1$  it is not strictly speaking possible to speak about indices since the matrix elements are traces of the S-matrix multiplied by projection operators to infinite-dimensional subspaces from right and left.

The functor property of S-matrices implies that they form a multiplicative structure analogous but not identical to groupoid [?]. Recall that groupoid has associative product and there exist always right and left inverses and identity in the sense that  $ff^{-1}$  and  $f^{-1}f$  are always defined but not identical and one has  $fgg^{-1} = f$  and  $f^{-1}fg = g$ .

The reason for the groupoid like property is that S-matrix is a map between state spaces associated with initial and final sets of partonic surfaces and these state spaces are different so that inverse must be replaced with right and left inverse. The defining conditions for groupoid are replaced with more general ones. Also now associativity holds but the role of inverse is taken by hermitian conjugate. Thus one has the conditions  $fgg^\dagger = f\rho_{g,+}$  and  $f^\dagger fg = \rho_{f,-}g$ , and the conditions  $ff^\dagger = \rho_+$  and  $f^\dagger f = \rho_-$  are satisfied. Here  $\rho_\pm$  is density matrix associated with positive/negative energy parts of zero energy state. If the inverses of the density matrices exist, groupoid axioms hold true since  $f_L^{-1} = f^\dagger \rho_{f,+}^{-1}$  satisfies  $ff_L^{-1} = Id_+$  and  $f_R^{-1} = \rho_{f,-}^{-1} f^\dagger$  satisfies  $f_R^{-1}f = Id_-$ .

There are good reasons to believe that also tensor product of its appropriate generalization to the analog of co-product makes sense with non-triviality characterizing the interaction between the systems of the tensor product. If so, the S-matrices would form very beautiful mathematical structure bringing in mind the corresponding structures for 2-tangles and N-tangles. Knowing how incredibly powerful the group like structures have been in physics one has good reasons to hope that groupoid like structure might help to deduce a lot of information about the quantum dynamics of TGD.

A word about nomenclature is in order.  $S$  has strong associations to unitarity and it might be appropriate to replace  $S$  with some other letter. The interpretation of S-matrix as a generalized Schrödinger amplitude would suggest  $\Psi$ -matrix. Since the interaction with Kea's M-theory blog at <http://kea-monad.blogspot.com/> ( $M$  denotes Monad or Motif in this context) was led to the realization of the connection with density matrix, also  $M$ -matrix might be considered. S-matrix as a functor from the category of Feynman cobordisms in turn suggests C or F. Or could just Matrix denoted by  $M$  in formulas be enough? Certainly it would inspire feeling of awe!

## 7.3 Further ideas

The work of John Baez and students has inspired also the following ideas about the role of category theory in TGD.

### 7.3.1 Operads, number theoretical braids, and inclusions of HFFs

The description of braids leads naturally to category theory and quantum groups when the braiding operation, which can be regarded as a functor, is not a mere permutation. Discreteness is a natural notion in the category theoretical context. To me the most natural manner to interpret discreteness is - not something emerging in Planck scale- but as a correlate for a finite measurement resolution and quantum measurement theory with finite measurement resolution leads naturally to number theoretical braids as fundamental discrete structures so that category theoretic approach becomes well-motivated. Discreteness is also implied by the number theoretic approach to quantum TGD from number theoretic associativity condition [?] central also for category theoretical thinking as well as from the realization of number theoretical universality by the fusion of real and p-adic physics to single coherent whole.

Operads are formally single object multi-categories [?, ?]. This object consist of an infinite sequence of sets of n-ary operations. These operations can be composed and the compositions are associative (operations themselves need not be associative) in the sense that there is natural isomorphism (symmetries) mapping differently bracketed compositions to each other. The coherence laws for operads formulate the effect of permutations and bracketing (association) as functors acting as natural isomorphisms. A simple manner to visualize the composition is as an addition of  $n_1, \dots, n_k$  leaves to the leaves  $1, \dots, k$  of k-leaved tree.

An interesting example of operad is the braid operad formulating the combinatorics for a hierarchy of braids formed from braids by grouping subsets of braids having  $n_1, \dots, n_k$  strands and defining the strands of a  $k$ -braid. In TGD framework this grouping can be identified in terms of the formation



bound states of particles topologically condensed at larger space-time sheet and coherence laws allow to deduce information about scattering amplitudes. In conformal theories braided categories indeed allow to understand duality of stringy amplitudes in terms of associativity condition.

Planar operads [?] define an especially interesting class of operads. The reason is that the inclusions of HFFs give rise to a special kind of planar operad [?]. The object of this multi-category [?] consists of planar  $k$ -tangles. Planar operads are accompanied by planar algebras. It will be found that planar operads allow a generalization which could provide a description for the combinatorics of the generalized Feynman diagrams and also rigorous formulation for how the arrow of time emerges in TGD framework and related heuristic ideas challenging the standard views.

### 7.3.2 Generalized Feynman diagram as category?

John Baez has proposed a category theoretical formulation of quantum field theory as a functor from the category of  $n$ -cobordisms to the category of Hilbert spaces [?, ?]. The attempt to generalize this formulation looks well motivated in TGD framework because TGD can be regarded as almost topological quantum field theory in a well defined sense and braids appear as fundamental structures. It however seems that formulation as a functor from  $n\text{Cob}$  to  $\text{Hilb}$  is not general enough.

In zero energy ontology events of ordinary ontology become quantum states with positive and negative energy parts of quantum states localizable to the upper and lower light-like boundaries of causal diamond (CD).

1. Generalized Feynman diagrams associated with a given  $CD$  involve quantum superposition of light-like 3-surfaces corresponding to given generalized Feynman diagram. These superpositions could be seen as categories with 3-D light-like surfaces containing braids as arrows and 2-D vertices as objects. Zero energy states would represent quantum superposition of categories (different topologies of generalized Feynman diagram) and M-matrix defined as Connes tensor product would define a functor from this category to the Hilbert space of zero energy states for given  $CD$  (tensor product defines quite generally a functor).
2. What is new from the point of view of physics that the sequences of generalized lines would define compositions of arrows and morphisms having identification in terms of braids which replicate in vertices. The possible interpretation of the replication is in terms of copying of information in classical sense so that even elementary particles would be information carrying and processing structures. This structure would be more general than the proposal of John Baez that S-matrix corresponds to a function from the category of  $n$ -dimensional cobordisms to the category  $\text{Hilb}$ .
3. p-Adic length scale hypothesis follows if the temporal distance between the tips of  $CD$  measured as light-cone proper time comes as an octave of  $CP_2$  time scale:  $T = 2^n T_0$ . This assumption implies that the p-adic length scale resolution interpreted in terms of a hierarchy of increasing measurement resolutions comes as octaves of time scale. A weaker condition would be  $T_p = pT_0$ ,  $p$  prime, and would assign all p-adic time scales to the size scale hierarchy of  $CD$ s.

This preliminary picture is of course not far complete since it applies only to single  $CD$ . There are several questions. Can one allow  $CD$ s within  $CD$ s and is every vertex of generalized Feynman diagram surrounded by this kind of  $CD$ . Can one form unions of  $CD$ s freely?

1. Since light-like 3-surfaces in 8-D imbedding space have no intersections in the generic position, one could argue that the overlap must be allowed and makes possible the interaction of between zero energy states belonging to different  $CD$ s. This interaction would be something new and present also for sub- $CD$ s of a given  $CD$ .
2. The simplest guess is that the unrestricted union of  $CD$ s defines the counterpart of tensor product at geometric level and that extended M-matrix is a functor from this category to the tensor product of zero energy state spaces. For non-overlapping  $CD$ s ordinary tensor product could be in question and for overlapping  $CD$ s tensor product would be non-trivial. One could interpret this M-matrix as an arrow between M-matrices of zero energy states at different  $CD$ s: the analog of natural transformation mapping two functors to each other. This hierarchy could be continued ad infinitum and would correspond to the hierarchy of  $n$ -categories.

This rough heuristics represents of course only one possibility among many since the notion of category is extremely general and the only limits are posed by the imagination of the mathematician. Also the view about zero energy states is still rather primitive.

## 7.4 Planar operads, the notion of finite measurement resolution, and arrow of geometric time

In the sequel the idea that planar operads or their appropriate generalization might allow to formulate generalized Feynman diagrammatics in zero energy ontology will be considered. Also a description of measurement resolution and arrow of geometric time in terms of operads is discussed.

### 7.4.1 Zeroth order heuristics about zero energy states

Consider now the existing heuristic picture about the zero energy states and coupling constant evolution provided by  $CD$ s.

1. The tentative description for the increase of the measurement resolution in terms  $CD$ s is that one inserts to the upper and/or lower light-like boundary of  $CD$  smaller  $CD$ s by gluing them along light-like radial ray from the tip of  $CD$ . It is also possible that the vertices of generalized Feynman diagrams belong inside smaller  $CD$ s and it turns out that these  $CD$ s must be allowed.
2. The considerations related to the arrow of geometric time suggest that there is asymmetry between upper and lower boundaries of  $CD$ . The minimum requirement is that the measurement resolution is better at upper light-like boundary.
3. In zero energy ontology communications to the direction of geometric past are possible and phase conjugate laser photons represent one example of this.
4. Second law of thermodynamics must be generalized in such a manner that it holds with respect to subjective time identified as sequence of quantum jumps. The arrow of geometric time can however vary so that apparent breaking of second law is possible in shorter time scales at least. One must however understand why second law holds true in so good an approximation.
5. One must understand also why the contents of sensory experience is concentrated around a narrow time interval whereas the time scale of memories and anticipation are much longer. The proposed mechanism is that the resolution of conscious experience is higher at the upper boundary of  $CD$ . Since zero energy states correspond to light-like 3-surfaces, this could be a result of self-organization rather than a fundamental physical law.
  - (a)  $CD$ s define the perceptive field for self. Selves are curious about the space-time sheets outside their perceptive field in the geometric future of the imbedding space and perform quantum jumps tending to shift the superposition of the space-time sheets to the direction of geometric past (past defined as the direction of shift!). This creates the illusion that there is a time=snapshot front of consciousness moving to geometric future in fixed background space-time as an analog of train illusion.
  - (b) The fact that news come from the upper boundary of  $CD$  implies that self concentrates its attention to this region and improves the resolutions of sensory experience and quantum measurement here. The sub- $CD$ s generated in this manner correspond to mental images with contents about this region. As a consequence, the contents of conscious experience, in particular sensory experience, tend to be about the region near the upper boundary.
  - (c) This mechanism in principle allows the arrow of the geometric time to vary and depend on p-adic length scale and the level of dark matter hierarchy. The occurrence of phase transitions forcing the arrow of geometric time to be same everywhere are however plausible for the reason that the lower and upper boundaries of given  $CD$  must possess the same arrow of geometric time.
  - (d) If this is the mechanism behind the arrow of time, planar operads can provide a description of the arrow of time but not its explanation.

This picture is certainly not general enough, can be wrong at the level of details, and at best relates to the the whole like single particle wave mechanics to quantum field theory.

### 7.4.2 Planar operads

The geometric definition of planar operads [?, ?, ?, ?] without using the category theoretical jargon goes as follows.

1. There is an external disk and some internal disks and a collection of disjoint lines connecting disk boundaries.
2. To each disk one attaches a non-negative integer  $k$ , called the color of disk. The disk with color  $k$  has  $k$  points at each boundary with the labeling  $1, 2, \dots, k$  running clockwise and starting from a distinguished marked point, decorated by '\*'. A more restrictive definition is that disk colors are correspond to even numbers so that there are  $k = 2n$  points lines leaving the disk boundary boundary. The planar tangles with  $k = 2n$  correspond to inclusions of HFFs.
3. Each curve is either closed (no common points with disk boundaries) or joins a marked point to another marked point. Each marked point is the end point of exactly one curve.
4. The picture is planar meaning that the curves cannot intersect and disks cannot overlap.
5. Disks differing by isotopies preserving '\*s are equivalent.

Given a planar  $k$ -tangle-one of whose internal disks has color  $k_i$ - and a  $k_i$ -tangle  $S$ , one can define the tangle  $T \circ_i S$  by isotoping  $S$  so that its boundary, together with the marked points and the '\*s co-indices with that of  $D_i$  and after that erase the boundary of  $D_i$ . The collection of planar tangle together with the the composition defined in this manner- is called the colored operad of planar tangles.

One can consider also generalizations of planar operads.

1. The composition law is not affected if the lines of operads branch outside the disks. Branching could be allowed even at the boundaries of the disks although this does not correspond to a generic situation. One might call these operads branched operads.
2. The composition law could be generalized to allow additional lines connecting the points at the boundary of the added disk so that each composition would bring in something genuinely new. Zero energy insertion could correspond to this kind of insertions.
3. TGD picture suggests also the replacement of lines with braids. In category theoretical terms this means that besides association one allows also permutations of the points at the boundaries of the disks.

The question is whether planar operads or their appropriate generalizations could allow a characterization of the generalized Feynman diagrams representing the combinatorics of zero energy states in zero energy ontology and whether also the emergence of arrow of time could be described (but probably not explained) in this framework.

### 7.4.3 Planar operads and zero energy states

Are planar operads sufficiently powerful to code the vision about the geometric correlates for the increase of the measurement resolution and coupling constant evolution formulated in terms of  $CDs$ ? Or perhaps more realistically, could one improve this formulation by assuming that zero energy states correspond to wave functions in the space of planar tangles or of appropriate modifications of them? It seems that the answer to the first question is almost affirmative.

1. Disks are analogous to the white regions of a map whose details are not visible in the measurement resolution used. Disks correspond to causal diamonds ( $CDs$ ) in zero energy ontology. Physically the white regions relate to the vertices of the generalized Feynman diagrams and possibly also to the initial and final states (strictly speaking, the initial and final states correspond to the legs of generalized Feynman diagrams rather than their ends).

2. The composition of tangles means addition of previously unknown details to a given white region of the map and thus to an increase of the measurement resolution. This conforms with the interpretation of inclusions of HFFs as a characterization of finite measurement resolution and raises the hope that planar operads or their appropriate generalization could provide the proper language to describe coupling constant evolution and their perhaps even generalized Feynman diagrams.
3. For planar operad there is an asymmetry between the outer disk and inner disks. One might hope that this asymmetry could explain or at least allow to describe the arrow of time. This is not the case. If the disks correspond to causal diamonds ( $CD$ s) carrying positive *resp.* negative energy part of zero energy state at upper *resp.* lower light-cone boundary, the TGD counterpart of the planar tangle is  $CD$  containing smaller  $CD$ :s inside it. The smaller  $CD$ :s contain negative energy particles at their upper boundary and positive energy particles at their lower boundary. In the ideal resolution vertices represented 2-dimensional partonic at which light-like 3-surfaces meet become visible. There is no inherent asymmetry between positive and negative energies and no inherent arrow of geometric time at the fundamental level. It is however possible to model the arrow of time by the distribution of sub- $CD$ :s. By previous arguments self-organization of selves can lead to zero energy states for which the measurement resolution is better near the upper boundary of the  $CD$ .
4. If the lines carry fermion or anti-fermion number, the number of lines entering to a given  $CD$  must be even as in the case of planar operads as the following argument shows.
  - (a) In TGD framework elementary fermions correspond to single wormhole throat associated with topologically condensed  $CP_2$  type extremal and the signature of the induced metric changes at the throat.
  - (b) Elementary bosons correspond to pairs of wormhole throats associated with wormhole contacts connecting two space-time sheets of opposite time orientation and modellable as a piece of  $CP_2$  type extremal. Each boson therefore corresponds to 2 lines within  $CP_2$  radius.
  - (c) As a consequence the total number of lines associated with given  $CD$  is even and the generalized Feynman diagrams can correspond to a planar algebra associated with an inclusion of HFFs.
5. This picture does not yet describe zero energy insertions.
  - (a) The addition of zero energy insertions corresponds intuitively to the allowance of new lines inside the smaller  $CD$ :s not coming from the exterior. The addition of lines connecting points at the boundary of disk is possible without losing the basic geometric composition of operads. In particular one does not lose the possibility to color the added tangle using two colors (colors correspond to two groups  $G$  and  $H$  which characterize an inclusion of HFFs [?]).
  - (b) There is however a problem. One cannot remove the boundaries of sub- $CD$  after the composition of  $CD$ s since this would give lines beginning from and ending to the interior of disk and they are invisible only in the original resolution. Physically this is of course what one wants but the inclusion of planar tangles is expected to fail in its original form, and one must generalize the composition of tangles to that of  $CD$ :s so that the boundaries of sub- $CD$ :s are not thrown away in the process.
  - (c) It is easy to see that zero energy insertions are inconsistent with the composition of planar tangles. In the inclusion defining the composition of tangles both sub-tangle and tangle induce a color to a given segment of the inner disk. If these colors are identical, one can forget the presence of the boundary of the added tangle. When zero energy insertions are allowed, situation changes as is easy to see by adding a line connecting points in a segment of given color at the boundary of the included tangle. There exists no consistent coloring of the resulting structure by using only two colors. Coloring is however possible using four colors, which by four-color theorem is the minimum number of colors needed for a coloring of planar map: this however requires that the color can change as one moves through the boundary of the included disk - this is in accordance with the physical picture.

- (d) Physical intuition suggests that zero energy insertion as an improvement of measurement resolution maps to an improved color resolution and that the composition of tangles generalizes by requiring that the included disk is colored by using new nuances of the original colors. The role of groups in the definition of inclusions of HFFs is consistent with idea that  $G$  and  $H$  describe color resolution in the sense that the colors obtained by their action cannot be resolved. If so, the improved resolution means that  $G$  and  $H$  are replaced by their subgroups  $G_1 \subset G$  and  $H_1 \subset H$ . Since the elements of a subgroup have interpretation as elements of group, there are good hopes that by representing the inclusion of tangles as inclusion of groups, one can generalize the composition of tangles.
6. Also  $CD$ :s glued along light-like ray to the upper and lower boundaries of  $CD$  are possible in principle and -according the original proposal- correspond to zero energy insertions according. These  $CD$ :s might be associated with the phase transitions changing the value of  $\hbar$  leading to different pages of the book like structure defined by the generalized imbedding space.
  7. p-Adic length scale hypothesis is realized if the hierarchy of  $CD$ s corresponds to a hierarchy of temporal distances between tips of  $CD$ s given as  $a = T_n = 2^{-n}T_0$  using light-cone proper time.
  8. How this description relates to braiding? Each line corresponds to an orbit of a partonic boundary component and in principle one must allow internal states containing arbitrarily high fermion and antifermion numbers. Thus the lines decompose into braids and one must allow also braids of braids hierarchy so that each line corresponds to a braid operad in improved resolution.

#### 7.4.4 Relationship to ordinary Feynman diagrammatics

The proposed description is not equivalent with the description based on ordinary Feynman diagrams.

1. In standard physics framework the resolution scale at the level of vertices of Feynman diagrams is something which one is forced to pose in practical calculations but cannot pose at will as opposed to the measurement resolution. Light-like 3-surfaces can be however regarded only locally orbits of partonic 2-surfaces since generalized conformal invariance is true only in 3-D patches of the light-like 3-surface. This means that light-like 3-surfaces are in principle the fundamental objects so that zero energy states can be regarded only locally as a time evolutions. Therefore measurement resolution can be applied also to the distances between vertices of generalized Feynman diagrams and calculational resolution corresponds to physical resolution. Also the resolution can be better towards upper boundary of  $CD$  so that the arrow of geometric time can be understood. This is a definite prediction which can in principle kill the proposed scenario.
2. A further counter argument is that generalized Feynman diagrams are identified as light-like 3-surfaces for which Kähler function defined by a preferred extremal of Kähler action is maximum. Therefore one cannot pose any ad hoc rules on the positions of the vertices. One can of course insist that maximum of Kähler function with the constraint posed by  $T_n = 2^n T_0$  (or  $T_p = p T_0$ ) hierarchy is in question.

It would be too optimistic to believe that the details of the proposal are correct. However, if the proposal is on correct track, zero energy states could be seen as wave functions in the operad of generalized tangles (zero energy insertions and braiding) as far as combinatorics is involved and the coherence rules for these operads would give strong constraints on the zero energy state and fix the general structure of coupling constant evolution.

## 7.5 Category theory and symplectic QFT

Besides the counterpart of the ordinary Kac-Moody invariance quantum TGD possesses so called super-symplectic conformal invariance. This symmetry leads to the proposal that a symplectic variant of conformal field theory should exist. The  $n$ -point functions of this theory defined in  $S^2$  should be expressible in terms of symplectic areas of triangles assignable to a set of  $n$ -points and satisfy the duality rules of conformal field theories guaranteeing associativity. The crucial prediction is that symplectic  $n$ -point functions vanish whenever two arguments co-incide. This provides a mechanism

guaranteeing the finiteness of quantum TGD implied by very general arguments relying on non-locality of the theory at the level of 3-D surfaces.

The classical picture suggests that the generators of the fusion algebra formed by fields at different point of  $S^2$  have this point as a continuous index. Finite quantum measurement resolution and category theoretic thinking in turn suggest that only the points of  $S^2$  corresponding the strands of number theoretic braids are involved. It turns out that the category theoretic option works and leads to an explicit hierarchy of fusion algebras forming a good candidate for so called little disk operad whereas the first option has difficulties.

### 7.5.1 Fusion rules

Symplectic fusion rules are non-local and express the product of fields at two points  $s_k$  and  $s_l$  of  $S^2$  as an integral over fields at point  $s_r$ , where integral can be taken over entire  $S^2$  or possibly also over a 1-D curve which is symplectic invariant in some sense. Also discretized version of fusion rules makes sense and is expected serve as a correlate for finite measurement resolution.

By using the fusion rules one can reduce n-point functions to convolutions of 3-point functions involving a sequence of triangles such that two subsequent triangles have one vertex in common. For instance, 4-point function reduces to an expression in which one integrates over the positions of the common vertex of two triangles whose other vertices have fixed. For n-point functions one has n-3 freely varying intermediate points in the representation in terms of 3-point functions.

The application of fusion rules assigns to a line segment connecting the two points  $s_k$  and  $s_l$  a triangle spanned by  $s_k$ ,  $s_l$  and  $s_r$ . This triangle should be symplectic invariant in some sense and its symplectic area  $A_{klm}$  would define the basic variable in terms of which the fusion rule could be expressed as  $C_{klm} = f(A_{klm})$ , where  $f$  is fixed by some constraints. Note that  $A_{klm}$  has also interpretations as solid angle and magnetic flux.

### 7.5.2 What conditions could fix the symplectic triangles?

The basic question is how to identify the symplectic triangles. The basic criterion is certainly the symplectic invariance: if one has found N-D symplectic algebra, symplectic transformations of  $S^2$  must provide a new one. This is guaranteed if the areas of the symplectic triangles remain invariant under symplectic transformations. The questions are how to realize this condition and whether it might be replaced with a weaker one. There are two approaches to the problem.

#### Physics inspired approach

In the first approach inspired by classical physics symplectic invariance for the edges is interpreted in the sense that they correspond to the orbits of a charged particle in a magnetic field defined by the Kähler form. Symplectic transformation induces only a  $U(1)$  gauge transformation and leaves the orbit of the charged particle invariant if the vertices are not affected since symplectic transformations are not allowed to act on the orbit directly in this approach. The general functional form of the structure constants  $C_{klm}$  as a function  $f(A_{klm})$  of the symplectic area should guarantee fusion rules.

If the action of the symplectic transformations does not affect the areas of the symplectic triangles, the construction is invariant under general symplectic transformations. In the case of uncharged particle this is not the case since the edges are pieces of geodesics: in this case however fusion algebra however trivializes so that one cannot conclude anything. In the case of charged particle one might hope that the area remains invariant under general symplectic transformations whose action is induced from the action on vertices. The equations of motion for a charged particle involve a Kähler metric determined by the symplectic structure and one might hope that this is enough to achieve this miracle. If this is not the case - as it might well be - one might hope that although the areas of the triangles are not preserved, the triangles are mapped to each other in such a manner that the fusion algebra rules remain intact with a proper choice of the function  $f(A_{klm})$ . One could also consider the possibility that the function  $f(A_{klm})$  is dictated from the condition that the it remains invariant under symplectic transformations. It however turns that this approach does not work as such.

### Category theoretical approach

The second realization is guided by the basic idea of category theoretic thinking: the properties of an object are determined its relationships to other objects. Rather than postulating that the symplectic triangle is something which depends solely on the three points involved via some geometric notion like that of geodesic line of orbit of charged particle in magnetic field, one assumes that the symplectic triangle reflects the properties of the fusion algebra, that is the relations of the symplectic triangle to other symplectic triangles. Thus one must assign to each triplet  $(s_1, s_2, s_3)$  of points of  $S^2$  a triangle just from the requirement that braided associativity holds true for the fusion algebra.

All symplectic transformations leaving the  $N$  points fixed and thus generated by Hamiltonians vanishing at these points would give new gauge equivalent realizations of the fusion algebra and deform the edges of the symplectic triangles without affecting their area. One could even say that symplectic triangulation defines a new kind geometric structure in  $S^2$ . The quantum fluctuating degrees of freedom are parameterized by the symplectic group of  $S^2 \times CP_2$  in TGD so that symplectic the geometric representation of the triangulation changes but its inherent properties remain invariant.

The elegant feature of category theoretical approach is that one can in principle construct the fusion algebra without any reference to its geometric realization just from the braided associativity and nilpotency conditions and after that search for the geometric realizations. Fusion algebra has also a hierarchy of discrete variants in which the integral over intermediate points in fusion is replaced by a sum over a fixed discrete set of points and this variant is what finite measurement resolution implies. In this case it is relatively easy to see if the geometric realization of a given abstract fusion algebra is possible.

### The notion of number theoretical braid

Braids -not necessary number theoretical- provide a realization discretization as a space-time correlate for the finite measurement resolution. The notion of braid was inspired by the idea about quantum TGD as almost topological quantum field theory. Although the original form of this idea has been buried, the notion of braid has survived: in the decomposition of space-time sheets to string world sheets, the ends of strings define representatives for braid strands at light-like 3-surfaces.

The notion of number theoretic universality inspired the much more restrictive notion of number theoretic braid requiring that the points in the intersection of the braid with the partonic 2-surface correspond to rational or at most algebraic points of  $H$  in preferred coordinates fixed by symmetry considerations. The challenge has been to find a unique identification of the number theoretic braid or at least of the end points of the braid. The following consideration suggest that the number theoretic braids are not a useful notion in the generic case but make sense and are needed in the intersection of real and p-adic worlds which is in crucial role in TGD based vision about living matter [K42] .

It is only the braiding that matters in topological quantum field theories used to classify braids. Hence braid should require only the fixing of the end points of the braids at the intersection of the braid at the light-like boundaries of  $CDs$  and the braiding equivalence class of the braid itself. Therefore it is enough is to specify the topology of the braid and the end points of the braid in accordance with the attribute "number theoretic". Of course, the condition that all points of the strand of the number theoretic braid are algebraic is impossible to satisfy.

The situation in which the equations defining  $X^2$  make sense both in real sense and p-adic sense using appropriate algebraic extension of p-adic number field is central in the TGD based vision about living matter [K42] . The reason is that in this case the notion of number entanglement theoretic entropy having negative values makes sense and entanglement becomes information carrying. This motivates the identification of life as something in the intersection of real and p-adic worlds. In this situation the identification of the ends of the number theoretic braid as points belonging to the intersection of real and p-adic worlds is natural. These points -call them briefly algebraic points- belong to the algebraic extension of rationals needed to define the algebraic extension of p-adic numbers. This definition however makes sense also when the equations defining the partonic 2-surfaces fail to make sense in both real and p-adic sense. In the generic case the set of points satisfying the conditions is discrete. For instance, according to Fermat's theorem the set of rational points satisfying  $X^n + Y^n = Z^n$  reduces to the point  $(0,0,0)$  for  $n = 3, 4, \dots$ . Hence the constraint might be quite enough in the intersection of real and p-adic worlds where the choice of the algebraic extension is unique.

One can however criticize this proposal.

1. One must fix the the number of points of the braid and outside the intersection and the non-uniqueness of the algebraic extension makes the situation problematic. Physical intuition suggests that the points of braid define carriers of quantum numbers assignable to second quantized induced spinor fields so that the total number of fermions antifermions would define the number of braids. In the intersection the highly non-trivial implication is that this number cannot exceed the number of algebraic points.
2. In the generic case one expects that even the smallest deformation of the partonic 2-surface can change the number of algebraic points and also the character of the algebraic extension of rational numbers needed. The restriction to rational points is not expected to help in the generic case. If the notion of number theoretical braid is meant to be practical, must be able to decompose WCW to open sets inside which the numbers of algebraic points of braid at its ends are constant. For real topology this is expected to be impossible and it does not make sense to use p-adic topology for WCW whose points do not allow interpretation as p-adic partonic surfaces.
3. In the intersection of real and p-adic worlds which corresponds to a discrete subset of WCW, the situation is different. Since the coefficients of polynomials involved with the definition of the partonic 2-surface must be rational or at most algebraic, continuous deformations are not possible so that one avoids the problem.
4. This forces to ask the reason why for the number theoretic braids. In the generic case they seem to produce only troubles. In the intersection of real and p-adic worlds they could however allow the construction of the elements of  $M$ -matrix describing quantum transitions changing p-adic to real surfaces and vice versa as realizations of intentions and generation of cognitions. In this the case it is natural that only the data from the intersection of the two worlds are used. In [K42] I have sketched the idea about number theoretic quantum field theory as a description of intentional action and cognition.

There is also the the problem of fixing the interior points of the braid modulo deformations not affecting the topology of the braid.

1. Infinite number of non-equivalent braidings are possible. Should one allow all possible braidings for a fixed light-like 3-surface and say that their existence is what makes the dynamics essentially three-dimensional even in the topological sense? In this case there would be no problems with the condition that the points at both ends of braid are algebraic.
2. Or should one try to characterize the braiding uniquely for a given partonic 2-surfaces and corresponding 4-D tangent space distributions? The slicing of the space-time sheet by partonic 2-surfaces and string world sheets suggests that the ends of string world sheets could define the braid strands in the generic context when there is no algebraicity condition involved. This could be taken as a very natural manner to fix the topology of braid but leave the freedom to choose the representative for the braid. In the intersection of real and p-adic worlds there is no good reason for the end points of strands in this case to be algebraic at both ends of the string world sheet. One can however start from the braid defined by the end points of string world sheets, restrict the end points to be algebraic at the end with a smaller number of algebraic points and and then perform a topologically non-trivial deformation of the braid so that also the points at the other end are algebraic? Non-trivial deformations need not be possible for all possible choices of algebraic braid points at the other end of braid and different choices of the set of algebraic points would give rise to different braidings. A further constraint is that only the algebraic points at which one has assign fermion or antifermion are used so that the number of braid points is not always maximal.
3. One can also ask whether one should perform the gauge fixing for the strands of the number theoretic braid using algebraic functions making sense both in real and p-adic context. This question does not seem terribly relevant since since it is only the topology of the braid that matters.



### Symplectic triangulations and braids

The identification of the edges of the symplectic triangulation as the end points of the braid is favored by conceptual economy. The nodes of the symplectic triangulation would naturally correspond to the points in the intersection of the braid with the light-like boundaries of  $CD$  carrying fermion or antifermion number. The number of these points could be arbitrarily large in the generic case but in the intersection of real and p-adic worlds these points correspond to subset of algebraic points belonging to the algebraic extension of rationals associated with the definition of partonic 2-surfaces so that the sum of fermion and antifermion numbers would be bounded above. The presence of fermions in the nodes would be the physical prerequisite for measuring the phase factors defined by the magnetic fluxes. This could be understood in terms of gauge invariance forcing to assign to a pair of points of triangulation the non-integrable phase factor defined by the Kähler gauge potential.

The remaining problem is how uniquely the edges of the triangulation can be determined.

1. The allowance of all possible choices for edges would bring in an infinite number of degrees of freedom. These curves would be analogous to freely vibrating strings. This option is not attractive. One should be able to pose conditions on edges and whatever the manner to specify the edges might be, it must make sense also in the intersection of real and p-adic worlds. In this case the total phase factor must be a root of unity in the algebraic extension of rationals involved and this poses quantization rules analogous to those for magnetic flux. The strongest condition is that the edges are such that the non-integrable phase factor is a root of unity for each edge. It will be found that similar quantization is implied also by the associativity conditions and this justifies the interpretation of phase factors defining the fusion algebra in terms of the Kähler magnetic fluxes. This would pose strong constraints on the choice of edges but would not fix completely the phase factors, and it seems that one must allow all possible triangulations consistent with this condition and the associativity conditions so that physical state is a quantum superposition over all possible symplectic triangulations characterized by the fusion algebras.
2. In the real context one would have an infinite hierarchy of symplectic triangulations and fusion algebras satisfying the associativity conditions with the number of edges equal to the total number  $N$  of fermions and antifermions. Encouragingly, this hierarchy corresponds also to a hierarchy of  $\mathcal{N} = N$  SUSY algebras [?] (large values of  $\mathcal{N}$  are not a catastrophe in TGD framework since the physical content of SUSY symmetry is not the same as that in the standard approach). In the intersection of real and p-adic worlds the value of  $\mathcal{N}$  would be bounded by the total number of algebraic points. Hence the notion of finite measurement resolution, cutoff in  $\mathcal{N}$  and bound on the total fermion number would make physics very simple in the intersection of real and p-adic worlds.

Two kinds of symplectic triangulations are possible since one can use the symplectic forms associated with  $CP_2$  and  $r_M = \text{constant}$  sphere  $S^2$  of light-cone boundary. For a given collection of nodes the choices of edges could be different for these two kinds of triangulations. Physical state would be proportional to the product of the phase factors assigned to these triangulations.

#### 7.5.3 Associativity conditions and braiding

The generalized fusion rules follow from the associativity condition for n-point functions modulo phase factor if one requires that the factor assignable to n-point function has interpretation as n-point function. Without this condition associativity would be trivially satisfied by using a product of various bracketing structures for the  $n$  fields appearing in the n-point function. In conformal field theories the phase factor defining the associator is expressible in terms of the phase factor associated with permutations represented as braidings and the same is expected to be true also now.

1. Already in the case of 4-point function there are three different choices corresponding to the 4 possibilities to connect the fixed points  $s_k$  and the varying point  $s_r$  by lines. The options are (1-2, 3-4), (1-3,2-4), and (1-4,2-3) and graphically they correspond to s-, t-, and u-channels in string diagrams satisfying also this kind of fusion rules. The basic condition would be that same amplitude results irrespective of the choice made. The duality conditions guarantee associativity

in the formation of the n-point amplitudes without any further assumptions. The reason is that the writing explicitly the expression for a particular bracketing of n-point function always leads to some bracketing of one particular 4-point function and if duality conditions hold true, the associativity holds true in general. To be precise, in quantum theory associativity must hold true only in projective sense, that is only modulo a phase factor.

2. This framework encourages category theoretic approach. Besides different bracketing there are different permutations of the vertices of the triangle. These permutations can induce a phase factor to the amplitude so that braid group representations are enough. If one has representation for the basic braiding operation as a quantum phase  $q = \exp(i2\pi/N)$ , the phase factors relating different bracketings reduce to a product of these phase factors since  $(AB)C$  is obtained from  $A(BC)$  by a cyclic permutation involving to permutations represented as a braiding. Yang-Baxter equations express the reduction of associator to braidings. In the general category theoretical setting associators and braidings correspond to natural isomorphisms leaving category theoretical structure invariant.
3. By combining the duality rules with the condition that 4-point amplitude vanishes, when any two points co-incide, one obtains from  $s_k = s_l$  and  $s_m = s_n$  the condition stating that the sum (or integral in possibly existing continuum version) of  $U^2(A_{klm})|f|^2(x_{kmr})$  over the third point  $s_r$  vanishes. This requires that the phase factor  $U$  is non-trivial so that  $Q$  must be non-vanishing if one accepts the identification of the phase factor as Bohm-Aharonov phase.
4. Braiding operation gives naturally rise to a quantum phase. A good guess is that braiding operation maps triangle to its complement since only in this manner orientation is preserved so that area is  $A_{klm}$  is mapped to  $A_{klm} - 4\pi$ . If the  $f$  is proportional to the exponent  $\exp(-A_{klm}Q)$ , braiding operation induces a complex phase factor  $q = \exp(-i4\pi Q)$ .
5. For half-integer values of  $Q$  the algebra is commutative. For  $Q = M/N$ , where  $M$  and  $N$  have no common factors, only braided commutativity holds true for  $N \geq 3$  just as for quantum groups characterizing also Jones inclusions of HFFs. For  $N = 4$  anti-commutativity and associativity hold true. Charge fractionization would correspond to non-trivial braiding and presumably to non-standard values of Planck constant and coverings of  $M^4$  or  $CP_2$  depending on whether  $S^2$  corresponds to a sphere of light-cone boundary or homologically trivial geodesic sphere of  $CP_2$ .

#### 7.5.4 Finite-dimensional version of the fusion algebra

Algebraic discretization due to a finite measurement resolution is an essential part of quantum TGD. In this kind of situation the symplectic fields would be defined in a discrete set of  $N$  points of  $S^2$ : natural candidates are subsets of points of p-adic variants of  $S^2$ . Rational variant of  $S^2$  has as its points points for which trigonometric functions of  $\theta$  and  $\phi$  have rational values and there exists an entire hierarchy of algebraic extensions. The interpretation for the resulting breaking of the rotational symmetry would be a geometric correlate for the choice of quantization axes in quantum measurement and the book like structure of the imbedding space would be direct correlate for this symmetry breaking. This approach gives strong support for the category theory inspired philosophy in which the symplectic triangles are dictated by fusion rules.

#### General observations about the finite-dimensional fusion algebra

1. In this kind of situation one has an algebraic structure with a finite number of field values with integration over intermediate points in fusion rules replaced with a sum. The most natural option is that the sum is over all points involved. Associativity conditions reduce in this case to conditions for a finite set of structure constants vanishing when two indices are identical. The number  $M(N)$  of non-vanishing structure constants is obtained from the recursion formula  $M(N) = (N - 1)M(N - 1) + (N - 2)M(N - 2) + \dots + 3M(3) = NM(N - 1)$ ,  $M(3) = 1$  given  $M(4) = 4$ ,  $M(5) = 20$ ,  $M(6) = 120, \dots$  With a proper choice of the set of points associativity might be achieved. The structure constants are necessarily complex so that also the complex conjugate of the algebra makes sense.

2. These algebras resemble nilpotent algebras ( $x^n = 0$  for some  $n$ ) and Grassmann algebras ( $x^2 = 0$  always) in the sense that also the products of the generating elements satisfy  $x^2 = 0$  as one can find by using duality conditions on the square of a product  $x = yz$  of two generating elements. Also the products of more than  $N$  generating elements necessary vanish by braided commutativity so that nilpotency holds true. The interpretation in terms of measurement resolution is that partonic states and vertices can involve at most  $N$  fermions in this measurement resolution. Elements anti-commute for  $q = -1$  and commute for  $q = 1$  and the possibility to express the product of two generating elements as a sum of generating elements distinguishes these algebras from Grassman algebras. For  $q = -1$  these algebras resemble Lie-algebras with the difference that associativity holds true in this particular case.
3. I have not been able to find whether this kind of hierarchy of algebras corresponds to some well-known algebraic structure with commutativity and associativity possibly replaced with their braided counterparts. Certainly these algebras would be category theoretical generalization of ordinary algebras for which commutativity and associativity hold true in strict sense.
4. One could forget the representation of structure constants in terms of triangles and think these algebras as abstract algebras. The defining equations are  $x_i^2 = 0$  for generators plus braided commutativity and associativity. Probably there exists solutions to these conditions. One can also hope that one can construct braided algebras from commutative and associative algebras allowing matrix representations. Note that the solution the conditions allow scalings of form  $C_{klm} \rightarrow \lambda_k \lambda_l \lambda_m C_{klm}$  as symmetries.

#### Formulation and explicit solution of duality conditions in terms of inner product

Duality conditions can be formulated in terms of an inner product in the function space associated with  $N$  points and this allows to find explicit solutions to the conditions.

1. The idea is to interpret the structure constants  $C_{klm}$  as wave functions  $C_{kl}$  in a discrete space consisting of  $N$  points with the standard inner product

$$\langle C_{kl}, C_{mn} \rangle = \sum_r C_{klr} \overline{C_{mnr}} \quad . \quad (7.5.1)$$

2. The associativity conditions for a trivial braiding can be written in terms of the inner product as

$$\langle C_{kl}, \overline{C_{mn}} \rangle = \langle C_{km}, \overline{C_{ln}} \rangle = \langle C_{kn}, \overline{C_{ml}} \rangle \quad . \quad (7.5.2)$$

3. Irrespective of whether the braiding is trivial or not, one obtains for  $k = m$  the orthogonality conditions

$$\langle C_{kl}, \overline{C_{kn}} \rangle = 0 \quad . \quad (7.5.3)$$

For each  $k$  one has basis of  $N - 1$  wave functions labeled by  $l \neq k$ , and the conditions state that the elements of basis and conjugate basis are orthogonal so that conjugate basis is the dual of the basis. The condition that complex conjugation maps basis to a dual basis is very special and is expected to determine the structure constants highly uniquely.

4. One can also find explicit solutions to the conditions. The most obvious trial is based on orthogonality of function basis of circle providing representation for  $Z_{N-2}$  and is following:

$$C_{klm} = E_{klm} \times \exp(i\phi_k + \phi_l + \phi_m) \quad , \quad \phi_m = \frac{n(m)2\pi}{N-2} \quad . \quad (7.5.4)$$

Here  $E_{klm}$  is non-vanishing only if the indices have different values. The ansatz reduces the conditions to the form

$$\sum_r E_{klr} E_{mnr} \exp(i2\phi_r) = \sum_r E_{kmr} E_{lnr} \exp(i2\phi_r) = \sum_r E_{knr} E_{mlr} \exp(i2\phi_r) . \quad (7.5.5)$$

In the case of braiding one can allow overall phase factors. Orthogonality conditions reduce to

$$\sum_r E_{klr} E_{knr} \exp(i2\phi_r) = 0 . \quad (7.5.6)$$

If the integers  $n(m)$ ,  $m \neq k, l$  span the range  $(0, N - 3)$  orthogonality conditions are satisfied if one has  $E_{klr} = 1$  when the indices are different. This guarantees also duality conditions since the inner products involving  $k, l, m, n$  reduce to the same expression

$$\sum_{r \neq k, l, m, n} \exp(i2\phi_r) . \quad (7.5.7)$$

5. For a more general choice of phases the coefficients  $E_{klm}$  must have values differing from unity and it is not clear whether the duality conditions can be satisfied in this case.

### Do fusion algebras form little disk operad?

The improvement of measurement resolution means that one adds further points to an existing set of points defining a discrete fusion algebra so that a small disk surrounding a point is replaced with a little disk containing several points. Hence the hierarchy of fusion algebras might be regarded as a realization of a little disk operad [?] and there would be a hierarchy of homomorphisms of fusion algebras induced by the fusion. The inclusion homomorphism should map the algebra elements of the added points to the algebra element at the center of the little disk.

A more precise prescription goes as follows.

1. The replacement of a point with a collection of points in the little disk around it replaces the original algebra element  $\phi_{k_0}$  by a number of new algebra elements  $\phi_K$  besides already existing elements  $\phi_k$  and brings in new structure constants  $C_{KLM}$ ,  $C_{KLk}$  for  $k \neq k_0$ , and  $C_{Klm}$ .
2. The notion of improved measurement resolution allows to conclude

$$C_{KLk} = 0 , \quad k \neq k_0 , \quad C_{Klm} = C_{k_0lm} . \quad (7.5.8)$$

3. In the homomorphism of new algebra to the original one the new algebra elements and their products should be mapped as follows:

$$\begin{aligned} \phi_K &\rightarrow \phi_{k_0} , \\ \phi_K \phi_L &\rightarrow \phi_{k_0}^2 = 0 , \quad \phi_K \phi_l \rightarrow \phi_{k_0} \phi_l . \end{aligned} \quad (7.5.9)$$

Expressing the products in terms of structure constants gives the conditions

$$\sum_M C_{KLM} = 0 , \quad \sum_r C_{Klr} = \sum_r C_{k_0lr} = 0 . \quad (7.5.10)$$

The general ansatz for the structure constants based on roots of unity guarantees that the conditions hold true.

- Note that the resulting algebra is more general than that given by the basic ansatz since the improvement of the measurement resolution at a given point can correspond to different value of  $N$  as that for the original algebra given by the basic ansatz. Therefore the original ansatz gives only the basic building bricks of more general fusion algebras. By repeated local improvements of the measurement resolution one obtains an infinite hierarchy of algebras labeled by trees in which each improvement of measurement resolution means the splitting of the branch with arbitrary number  $N$  of branches. The number of improvements of the measurement resolution defining the height of the tree is one invariant of these algebras. The fusion algebra operad has a fractal structure since each point can be replaced by any fusion algebra.

### How to construct geometric representation of the discrete fusion algebra?

Assuming that solutions to the fusion conditions are found, one could try to find whether they allow geometric representations. Here the category theoretical philosophy shows its power.

- Geometric representations for  $C_{klm}$  would result as functions  $f(A_{klm})$  of the symplectic area for the symplectic triangles assignable to a set of  $N$  points of  $S^2$ .
- If the symplectic triangles can be chosen freely apart from the area constraint as the category theoretic philosophy implies, it should be relatively easy to check whether the fusion conditions can be satisfied. The phases of  $C_{klm}$  dictate the areas  $A_{klm}$  rather uniquely if one uses Bohm-Aharonov ansatz for a fixed the value of  $Q$ . The selection of the points  $s_k$  would be rather free for phases near unity since the area of the symplectic triangle associated with a given triplet of points can be made arbitrarily small. Only for the phases far from unity the points  $s_k$  cannot be too close to each other unless  $Q$  is very large. The freedom to chose the points rather freely conforms with the general view about the finite measurement resolution as the origin of discretization.
- The remaining conditions are on the moduli  $|f(A_{klm})|$ . In the discrete situation it is rather easy to satisfy the conditions just by fixing the values of  $f$  for the particular triangles involved:  $|f(A_{klm})| = |C_{klm}|$ . For the exact solution to the fusion conditions  $|f(A_{klm})| = 1$  holds true.
- Constraints on the functional form of  $|f(A_{klm})|$  for a fixed value of  $Q$  can be deduced from the correlation between the modulus and phase of  $C_{klm}$  without any reference to geometric representations. For the exact solution of fusion conditions there is no correlation.
- If the phase of  $C_{klm}$  has  $A_{klm}$  as its argument, the decomposition of the phase factor to a sum of phase factors means that the  $A_{klm}$  is sum of contributions labeled by the vertices. Also the symplectic area defined as a magnetic flux over the triangle is expressible as sum of the quantities  $\int A_\mu dx^\mu$  associated with the edges of the triangle. These fluxes should correspond to the fluxes assigned to the vertices deduced from the phase factors of  $\Psi(s_k)$ . The fact that vertices are ordered suggest that the phase of  $\Psi(s_j)$  fixes the value of  $\int A_\mu dx^\mu$  for an edge of the triangle starting from  $s_k$  and ending to the next vertex in the ordering. One must find edges giving a closed triangle and this should be possible. The option for which edges correspond to geodesics or to solutions of equations of motion for a charged particle in magnetic field is not flexible enough to achieve this purpose.
- The quantization of the phase angles as multiples of  $2\pi/(N-2)$  in the case of  $N$ -dimensional fusion algebra has a beautiful geometric correlate as a quantization of symplecto-magnetic fluxes identifiable as symplectic areas of triangles defining solid angles as multiples of  $2\pi/(N-2)$ . The generalization of the fusion algebra to p-adic case exists if one allows algebraic extensions containing the phase factors involved. This requires the allowance of phase factors  $\exp(i2\pi/p)$ ,  $p$  a prime dividing  $N-2$ . Only the exponents  $\exp(i \int A_\mu dx^\mu) = \exp(in2\pi/(N-2))$  exist p-adically. The p-adic counterpart of the curve defining the edge of triangle exists if the curve can be defined purely algebraically (say as a solution of polynomial equations with rational coefficients) so that p-adic variant of the curve satisfies same equations.

### Does a generalization to the continuous case exist?

The idea that a continuous fusion algebra could result as a limit of its discrete version does not seem plausible. The reason is that the spatial variation of the phase of the structure constants increases as the spatial resolution increases so that the phases  $\exp(i\phi(s))$  cannot be continuous at continuum limit. Also the condition  $E_{klm} = 1$  for  $k \neq l \neq m$  satisfied by the explicit solutions to fusion rules fails to have direct generalization to continuum case.

To see whether the continuous variant of fusion algebra can exist, one can consider an approximate generalization of the explicit construction for the discrete version of the fusion algebra by the effective replacement of points  $s_k$  with small disks which are not allowed to intersect. This would mean that the counterpart  $E(s_k, s_l, s_m)$  vanishes whenever the distance between two arguments is below a cutoff a small radius  $d$ . Puncturing corresponds physically to the cutoff implied by the finite measurement resolution.

1. The ansatz for  $C_{klm}$  is obtained by a direct generalization of the finite-dimensional ansatz:

$$C_{klm} = \kappa_{s_k, s_l, s_m} \Psi(s_k) \Psi(s_l) \Psi(s_m) . \quad (7.5.11)$$

where  $\kappa_{s_k, s_l, s_m}$  vanishes whenever the distance of any two arguments is below the cutoff distance and is otherwise equal to 1.

2. Orthogonality conditions read as

$$\Psi(s_k) \Psi(s_l) \int \kappa_{s_k, s_l, s_r} \kappa_{s_k, s_n, s_r} \Psi^2(s_m) d\mu(s_r) = \Psi(s_k) \Psi(s_l) \int_{S^2(s_k, s_l, s_n)} \Psi^2(s_r) d\mu(s_r) = 0 \quad (7.5.12)$$

The resulting condition reads as

$$\int_{S^2(s_k, s_l, s_n)} \Psi^2(s_r) d\mu(s_r) = 0 \quad (7.5.13)$$

This condition holds true for any pair  $s_k, s_l$  and this might lead to difficulties.

3. The general duality conditions are formally satisfied since the expression for all fusion products reduces to

$$\begin{aligned} X &= \Psi(s_k) \Psi(s_l) \Psi(s_m) \Psi(s_n) X , \\ X &= \int_{S^2} \kappa_{s_k, s_l, s_m, s_n} \Psi(s_r) d\mu(s_r) \\ &= \int_{S^2(s_k, s_l, s_m, s_n)} \Psi(s_m) d\mu(s_r) \\ &= - \int_{D^2(s_i)} \Psi^2(s_r) d\mu(s_r) , \quad i = k, l, s, m . \end{aligned} \quad (7.5.14)$$

These conditions state that the integral of  $\Psi^2$  any disk of fixed radius  $d$  is same: this result follows also from the orthogonality condition. This condition might be difficult to satisfy exactly and the notion of finite measurement resolution might be needed. For instance, it might be necessary to restrict the consideration to a discrete lattice of points which would lead back to a discretized version of algebra. Thus it seems that the continuum generalization of the proposed solution to fusion rules does not work.

## 7.6 Could operads allow the formulation of the generalized Feynman rules?

The previous discussion of symplectic fusion rules leaves open many questions.

1. How to combine symplectic and conformal fields to what might be called symplecto-conformal fields?
2. The previous discussion applies only in super-symplectic degrees of freedom and the question is how to generalize the discussion to super Kac-Moody degrees of freedom.
3. How four-momentum and its conservation in the limits of measurement resolution enters this picture?
4. At least two operads related to measurement resolution seem to be present: the operads formed by the symplecto-conformal fields and by generalized Feynman diagrams. For generalized Feynman diagrams causal diamond ( $CD$ ) is the basic object whereas disks of  $S^2$  are the basic objects in the case of symplecto-conformal QFT with a finite measurement resolution. These two different views about finite measurement resolution should be more or less equivalent and one should understand this equivalence at the level of details.
5. Is it possible to formulate generalized Feynman diagrammatics and improved measurement resolution algebraically?

### 7.6.1 How to combine conformal fields with symplectic fields?

The conformal fields of conformal field theory should be somehow combined with symplectic scalar field to form what might be called symplecto-conformal fields.

1. The simplest thing to do is to multiply ordinary conformal fields by a symplectic scalar field so that the fields would be restricted to a discrete set of points for a given realization of  $N$ -dimensional fusion algebra. The products of these symplecto-conformal fields at different points would define a finite-dimensional algebra and the products of these fields at same point could be assumed to vanish.
2. There is a continuum of geometric realizations of the symplectic fusion algebra since the edges of symplectic triangles can be selected rather freely. The integrations over the coordinates  $z_k$  (most naturally the complex coordinate of  $S^2$  transforming linearly under rotations around quantization axes of angular momentum) restricted to the circle appearing in the definition of simplest stringy amplitudes would thus correspond to the integration over various geometric realizations of a given  $N$ -dimensional symplectic algebra.

Fusion algebra realizes the notion of finite measurement resolution. One implication is that all  $n$ -point functions vanish for  $n > N$ . Second implication could be that the points appearing in the geometric realizations of  $N$ -dimensional symplectic fusion algebra have some minimal distance. This would imply a cutoff to the multiple integrals over complex coordinates  $z_k$  varying along circle giving the analogs of stringy amplitudes. This cutoff is not absolutely necessary since the integrals defining stringy amplitudes are well-defined despite the singular behavior of  $n$ -point functions. One can also ask whether it is wise to introduce a cutoff that is not necessary and whether fusion algebra provides only a justification for the  $1 + i\epsilon$  prescription to avoid poles used to obtain finite integrals.

The fixed values for the quantities  $\int A_\mu dx^\mu$  along the edges of the symplectic triangles could indeed pose a lower limit on the distance between the vertices of symplectic triangles. Whether this occurs depends on what one precisely means with symplectic triangle.

1. The conformally invariant condition that the angles between the edges at vertices are smaller than  $\pi$  for triangle and larger than  $\pi$  for its conjugate is not enough to exclude loopy edges and one would obtain ordinary stringy amplitudes multiplied by the symplectic phase factors. The outcome would be an integral over arguments  $z_1, z_2, \dots, z_n$  for standard stringy  $n$ -point amplitude multiplied by a symplectic phase factor which is piecewise constant in the integration domain.

2. The condition that the points at different edges of the symplectic triangle can be connected by a geodesic segment belonging to the interior of the triangle is much stronger and would induce a length scale cutoff since loops cannot be used to create large enough value of  $\int A_\mu dx^\mu$  for a given side of triangle. Symplectic invariance would be obtained for small enough symplectic transformations. How to realize this cutoff at the level of calculations is not clear. One could argue that this problem need not have any nice solution and since finite measurement resolution requires only finite calculational resolution, the approximation allowing loopy edges is acceptable.
3. The restriction of the edges of the symplectic triangle within a tubular neighborhood of a geodesic - more more generally an orbit of charged particle - with thickness determined by the length scale resolution in  $S^2$  would also introduce the length scale cutoff with symplectic invariance within measurement resolution.

Symplecto-conformal should form an operad. This means that the improvement of measurement resolution should correspond also to an algebra homomorphism in which super-symplectic symplecto-conformal fields in the original resolution are mapped by algebra homomorphism into fields which contain sum over products of conformal fields at different points: for the symplectic parts of field the products reduces always to a sum over the values of field. For instance, if the field at point  $s$  is mapped to an average of fields at points  $s_k$ , nilpotency condition  $x^2 = 0$  is satisfied.

### 7.6.2 Symplecto-conformal fields in Super-Kac-Moody sector

The picture described above is an over-simplification since it applies only in super-symplectic degrees of freedom. The vertices of generalized Feynman diagrams are absent from the description and  $CP_2$  Kähler form induced to space-time surface which is absolutely essential part of quantum TGD is nowhere visible in the treatment.

How should one bring in Super Kac-Moody (SKM) algebra representing the stringy degrees of freedom in the conventional sense of the world? The condition that the basic building bricks are same for the treatment of these degrees of freedom is a valuable guideline.

1. In the transition from super-symplectic to SKM degrees of freedom the light-cone boundary is replaced with the light-like 3-surface  $X^3$  representing the light-like random orbit of parton and serving as the basic dynamical object of quantum TGD. The sphere  $S^2$  of light-cone boundary is in turn replaced with a partonic 2-surface  $X^2$ . This suggests how to proceed.
2. In the case of SKM algebra the symplectic fusion algebra is represented geometrically as points of partonic 2-surface  $X^2$  by replacing the symplectic form of  $S^2$  with the induced  $CP_2$  symplectic form at the partonic 2-surface and defining  $U(1)$  gauge field. This gives similar hierarchy of symplecto-conformal fields as in the super-symplectic case. This also realizes the crucial aspects of the classical dynamics defined by Kähler action. In particular, for vacuum 2-surfaces symplectic fusion algebra trivializes since Kähler magnetic fluxes vanish identically and 2-surfaces near vacua require a large value of  $N$  for the dimension of the fusion algebra since the available Kähler magnetic fluxes are small.
3. In super-symplectic case the projection along light-like ray allows to map the points at the light-cone boundaries of  $CD$  to points of same sphere  $S^2$ . In the case of light-like 3-surfaces light-like geodesics representing braid strands allow to map the points of the partonic two-surfaces at the future and past light-cone boundaries to the partonic 2-surface representing the vertex. The earlier proposal was that the ends of strands meet at the partonic 2-surface so that braids would replicate at vertices. The properties of symplectic fields would however force identical vanishing of the vertices if this were the case. There is actually no reason to assume this condition and with this assumption vertices involving total number  $N$  of incoming and outgoing strands correspond to symplecto-conformal  $N$ -point function as is indeed natural. Also now Kähler magnetic flux induces cutoff distance.
4. SKM braids reside at light-like 3-surfaces representing lines of generalized Feynman diagrams. If super-symplectic braids are needed at all, they must be assigned to the two light-like boundaries of  $CD$  meeting each other at the sphere  $S^2$  at which future and past directed light-cones meet.



### 7.6.3 The treatment of four-momentum and other quantum numbers

Four-momentum enjoys a special role in super-symplectic and SKM representations in that it does not correspond to a quantum number assignable to the generators of these algebras. It would be nice if the somewhat mysterious phase factors associated with the representation of the symplectic algebra could code for the four-momentum - or rather the analogs of plane waves representing eigenstates of four-momentum at the points associated with the geometric representation of the symplectic fusion algebra. The situation is more complex as the following considerations show.

#### The representation of longitudinal momentum in terms of phase factors

1. The generalized coset representation for super-symplectic and SKM algebras implies Equivalence Principle in the generalized sense that the differences of the generators of two super Virasoro algebras annihilate the physical states. In particular, the four-momenta associated with super-symplectic *resp.* SKM degrees of freedom are identified as inertial *resp.* gravitational four-momenta and are equal by Equivalence Principle. The question is whether four-momentum could be coded in both algebras in terms of non-integrable phase factors appearing in the representations of the symplectic fusion algebras.
2. Four different phase factors are needed if all components of four-momentum are to be coded. Both number theoretical vision about quantum TGD and the realization of the hierarchy of Planck constants assign to each point of space-time surface the same plane  $M^2 \subset M^4$  having as the plane of non-physical polarizations. This condition allows to assign to a given light-like partonic 3-surface unique extremal of Kähler action defining the Kähler function as the value of Kähler action. Also p-adic mass calculations support the view that the physical states correspond to eigen states for the components of longitudinal momentum only (also the parton model for hadrons assumes this). This encourages to think that only  $M^2$  part of four-momentum is coded by the phase factors. Transversal momentum squared would be a well defined quantum number and determined from mass shell conditions for the representations of super-symplectic (or equivalently SKM) conformal algebra much like in string model.
3. The phase factors associated with the symplectic fusion algebra mean a deviation from conformal n-point functions, and the innocent question is whether these phase factors could be identified as plane-wave phase factors associated with the transversal part of the four-momentum so that the n-point functions would be strictly analogous with stringy amplitudes. In fact, the identification of the phase factors  $\exp(i \int A_\mu dx^\mu / \hbar)$  along a path as a phase factors  $\exp(ip_{L,k} \Delta m^k)$  defined by the ends of the path and associated with the longitudinal part of four-momentum would correspond to an integral form of covariant constancy condition  $\frac{dx^\mu}{ds} (\partial_\mu - iA_\mu) \Psi = 0$  along the edge of the symplectic triangle of more general path. Second phase factor would come from the integral along the (most naturally) light-like curve defining braid strand associated with the point in question. A geometric representation for the two projections of the gravitational four-momentum would thus result in SKM degrees of freedom and apart from the non-uniqueness related to the multiples of  $2\pi$  the components of  $M^2$  momentum could be deduced from the phase factors. If one is satisfied with the projection of momentum in  $M^2$ , this is enough.
4. The phase factors assignable to  $CP_2$  Kähler gauge potential are Lorentz invariant unlike the phase factors assignable to four-momentum. One can try to resolve the problem by noticing an important delicacy involved with the formulation of quantum TGD as almost topological QFT. In order to have a non-vanishing four-momentum it is necessary to assume that  $CP_2$  Kähler form has Kähler gauge potential having  $M^4$  projection, which is Lorentz invariant constant vector in the direction of the vector field defined by light-cone proper time. One cannot eliminate this part of Kähler gauge potential by a gauge transformation since the symplectic transformations of  $CP_2$  do not induce genuine gauge transformations but only symmetries of vacuum extremals of Kähler action. The presence of the  $M^4$  projection is necessary for having a non-vanishing gravitational mass in the fundamental theory relying on Chern-Simons action for light-like 3-surface and the magnitude of this vector brings gravitational constant into TGD as a fundamental constant and its value is dictated by quantum criticality.

5. Since the phase of the time-like phase factor is proportional to the increment of the proper time coordinate of light-cone, it is also Lorentz invariant! Since the selection of  $S^2$  fixes a rest frame, one can however argue that the representation in terms of phases is only for the rest energy in the case of massive particle. Also number theoretic approach selects a preferred rest frame by assigning time direction to the hyper-quaternionic real unit. In the case of massless particle this interpretation does not work since the vanishing of the rest mass implies that light-like 3-surface is piece of light-cone boundary and thus vacuum extremal. p-Adic thermodynamics predicting small mass even for massless particles can save the situation. Second possibility is that the phase factor defined by Kähler gauge potential is proportional to the Kähler charge of the particle and vanishes for massless particles.
6. This picture would mean that the phase factors assignable to the symplectic triangles have nothing to do with momentum. Because the space-like phase factor  $\exp(iS_z \Delta\phi/\hbar)$  associated with the edge of the symplectic triangle is completely analogous to that for momentum, one can argue that the symplectic triangulation should define a kind of spin network utilized in discretized approaches to quantum gravity. The interpretation raises the question about the interpretation of the quantum numbers assignable to the Lorentz invariant phase factors defined by the  $CP_2$  part of  $CP_2$  Kähler gauge potential.
7. By generalized Equivalence Principle one should have two phase factors also in super-symplectic degrees of freedom in order to characterize inertial four-momentum and spin. The inclusion of the phase factor defined by the radial integral along light-like radial direction of the light-cone boundary gives an additional phase factor if the gauge potential of the symplectic form of the light-cone boundary contains a gradient of the radial coordinate  $r_M$  varying along light-rays. Gravitational constant would characterize the scale of the "gauge parts" of Kähler gauge potentials both in  $M^4$  and  $CP_2$  degrees of freedom. The identity of inertial and gravitational four-momenta means that super-symplectic and SKM algebras represent one and same symplectic field in  $S^2$  and  $X^2$ .
8. Equivalence Principle in the generalized form requires that also the super-symplectic representation allows two additional Lorentz invariant phase factors. These phase factors are obtained if the Kähler gauge potential of the light-cone boundary has a gauge part also in  $CP_2$ . The invariance under  $U(2) \subset SU(3)$  fixes the choice the gauge part to be proportional to the gradient of the  $U(2)$  invariant radial distance from the origin of  $CP_2$  characterizing the radii of 3-spheres around the origin. Thus  $M^4 \times CP_2$  would deviate from a pure Cartesian product in a very delicate manner making possible to talk about almost topological QFT instead of only topological QFT.

### The quantum numbers associated with phase factors for $CP_2$ parts of Kähler gauge potentials

Suppose that it is possible to assign two independent and different phase factors to the same geometric representation, in other words have two independent symplectic fields with the same geometric representation. The product of two symplectic fields indeed makes sense and satisfies the defining conditions. One can define prime symplectic algebras and decompose symplectic algebras to prime factors. Since one can allow permutations of elements in the products it becomes possible to detect the presence of product structure experimentally by detecting different combinations for products of phases caused by permutations realized as different combinations of quantum numbers assigned with the factors. The geometric representation for the product of  $n$  symplectic fields would correspond to the assignment of  $n$  edges to any pair of points. The question concerns the interpretation of the phase factors assignable to the  $CP_2$  parts of Kähler gauge potentials of  $S^2$  and  $CP_2$  Kähler form.

1. The only reasonable interpretation for the two additional phase factors would be in terms of two quantum numbers having both gravitational and inertial variants and identical by Equivalence Principle. These quantum numbers should be Lorentz invariant since they are associated with the  $CP_2$  projection of the Kähler gauge potential of  $CP_2$  Kähler form.
2. Color hyper charge and isospin are mathematically completely analogous to the components of four-momentum so that a possible identification of the phase factors is as a representation of

these quantum numbers. The representation of plane waves as phase factors  $\exp(ip_k \Delta m^k / \hbar)$  generalizes to the representation  $\exp(iQ_A \Delta \Phi^A / \hbar)$ , where  $\Phi_A$  are the angle variables conjugate to the Hamiltonians representing color hyper charge and isospin. This representation depends on end points only so that the crucial symplectic invariance with respect to the symplectic transformations respecting the end points of the edge is not lost ( $U(1)$  gauge transformation is induced by the scalar  $j^k A_k$ , where  $j^k$  is the symplectic vector field in question).

3. One must be cautious with the interpretation of the phase factors as a representation for color hyper charge and isospin since a breaking of color gauge symmetry would result since the phase factors associated with different values of color isospin and hypercharge would be different and could not correspond to same edge of symplectic triangle. This is questionable since color group itself represents symplectic transformations. The construction of  $CP_2$  as a coset space  $SU(3)/U(2)$  identifies  $U(2)$  as the holonomy group of spinor connection having interpretation as electro-weak group. Therefore also the interpretation of the phase factors in terms of em charge and weak charge can be considered. In TGD framework electro-weak gauge potential indeed suffer a non-trivial gauge transformation under color rotations so that the correlation between electro-weak quantum numbers and non-integrable phase factors in Cartan algebra of the color group could make sense. Electro-weak symmetry breaking would have a geometric correlate in the sense that different values of weak isospin cannot correspond to paths with same values of phase angles  $\Delta \Phi^A$  between end points.
4. If the phase factors associated with the  $M^4$  and  $CP_2$  are assumed to be identical, the existence of geometric representation is guaranteed. This however gives constraints between rest mass, spin, and color (or electro-weak) quantum numbers.

### Some general comments

Some further comments about phase factors are in order.

1. By number theoretical universality the plane wave factors associated with four-momentum must have values coming as roots of unity (just as for a particle in box consisting of discrete lattice of points). At light-like boundary the quantization conditions reduce to the condition that the value of light-like coordinate is rational of form  $m/N$ , if  $N$ :th roots of unity are allowed.
2. In accordance with the finite measurement resolution of four-momentum, four-momentum conservation is replaced by a weaker condition stating that the products of phase factors representing incoming and outgoing four-momenta are identical. This means that positive and negative energy states at opposite boundaries of  $CD$  would correspond to complex conjugate representations of the fusion algebra. In particular, the product of phase factors in the decomposition of the conformal field to a product of conformal fields should correspond to the original field value. This would give constraints on the trees physically possible in the operad formed by the fusion algebras. Quite generally, the phases expressible as products of phases  $\exp(in\pi/p)$ , where  $p \leq N$  is prime must be allowed in a given resolution and this suggests that the hierarchy of p-adic primes is involved. At the limit of very large  $N$  exact momentum conservation should emerge.
3. Super-conformal invariance gives rise to mass shell conditions relating longitudinal and transversal momentum squared. The massivation of massless particles by Higgs mechanism and p-adic thermodynamics pose additional constraints to these phase factors.

#### 7.6.4 What does the improvement of measurement resolution really mean?

To proceed one must give a more precise meaning for the notion of measurement resolution. Two different views about the improvement of measurement resolution emerge. The first one relies on the replacement of braid strands with braids applies in SKM degrees of freedom and the homomorphism maps symplectic fields into their products. The homomorphism based on the averaging of symplectic fields over added points consistent with the extension of fusion algebra described in previous section is very natural in super-symplectic degrees of freedom. The directions of these two algebra homomorphisms are different. The question is whether both can be involved with both super-symplectic and SKM case. Since the end points of SKM braid strands correspond to both super-symplectic and SKM degrees of freedom, it seems that division of labor is the only reasonable option.

1. Quantum classical correspondence requires that measurement resolution has a purely geometric meaning. A purely geometric manner to interpret the increase of the measurement resolution is as a replacement of a braid strand with a braid in the improved resolution. If one assigns the phase factor assigned with the fusion algebra element with four-momentum, the conservation of the phase factor in the associated homomorphism is a natural constraint. The mapping of a fusion algebra element (strand) to a product of fusion algebra elements (braid) allows to realize this condition. Similar mapping of field value to a product of field values should hold true for conformal parts of the fields. There exists a large number equivalent geometric representations for a given symplectic field value so that one obtains automatically an averaging in conformal degrees of freedom. This interpretation for the improvement of measurement resolution looks especially natural for SKM degrees of freedom for which braids emerge naturally.
2. One can also consider the replacement of symplecto-conformal field with an average over the points becoming visible in the improved resolution. In super-symplectic degrees of freedom this looks especially natural since the assignment of a braid with light-cone boundary is not so natural as with light-like 3-surface. This map does not conserve the phase factor but this could be interpreted as reflecting the fact that the values of the light-like radial coordinate are different for points involved. The proposed extension of the symplectic algebra proposed in the previous section conforms with this interpretation.
3. In the super-symplectic case the improvement of measurement resolution means improvement of angular resolution at sphere  $S^2$ . In SKM sector it means improved resolution for the position at partonic 2-surface. For SKM algebra the increase of the measurement resolution related to the braiding takes place inside light-like 3-surface. This operation corresponds naturally to an addition of sub- $CD$  inside which braid strands are replaced with braids. This is like looking with a microscope a particular part of line of generalized Feynman graph inside  $CD$  and corresponds to a genuine physical process inside parton. In super-symplectic case the replacement of a braid strand with braid (at light-cone boundary) is induced by the replacement of the projection of a point of a partonic 2-surface to  $S^2$  with a collection of points coming from several partonic 2-surfaces. This replaces the point  $s$  of  $S^2$  associated with  $CD$  with a set of points  $s_k$  of  $S^2$  associated with sub- $CD$ . Note that the solid angle spanned by these points can be rather larger so that zoom-up is in question.
4. The improved measurement resolution means that a point of  $S^2$  ( $X^2$ ) at boundary of  $CD$  is replaced with a point set of  $S^2$  ( $X^2$ ) assignable to sub- $CD$ . The task is to map the point set to a small disk around the point. Light-like geodesics along light-like  $X^3$  defines this map naturally in both cases. In super-symplectic case this map means scaling down of the solid angle spanned by the points of  $S^2$  associated with sub- $CD$ .

### 7.6.5 How do the operads formed by generalized Feynman diagrams and symplecto-conformal fields relate?

The discussion above leads to following overall view about the situation. The basic operation for both symplectic and Feynman graph operads corresponds to an improvement of measurement resolution. In the case of planar disk operad this means to a replacement of a white region of a map with smaller white regions. In the case of Feynman graph operad this means better space-time resolution leading to a replacement of generalized Feynman graph with a new one containing new sub- $CD$  bringing new vertices into daylight. For braid operad the basic operation means looking a braid strand with a microscope so that it can resolve into a braid: braid becomes a braid of braids. The latter two views are equivalent if sub- $CD$  contains the braid of braids.

The disks  $D^2$  of the planar disk operad has natural counterparts in both super-symplectic and SKM sector.

1. For the geometric representations of the symplectic algebra the image points vary in continuous regions of  $S^2$  ( $X^2$ ) since the symplectic area of the symplectic triangle is a highly flexible constraint. Posing the condition that any point at the edges of symplectic triangle can be connected to any another edge excludes symplectic triangles with loopy sides so that constraint becomes non-trivial. In fact, since two different elements of the symplectic algebra cannot

correspond to the same point for a given geometric representation, each element must correspond to a connected region of  $S^2$  ( $X^2$ ). This allows a huge number of representations related by the symplectic transformations  $S^2$  in super-symplectic case and by the symplectic transformations of  $CP_2$  in SKM case. In the case of planar disk operad different representations are related by isotopies of plane.

This decomposition to disjoint regions naturally correspond to the decomposition of the disk to disjoint regions in the case of planar disk operad and Feynman graph operad (allowing zero energy insertions). Perhaps one might say that  $N$ -dimensional elementary symplectic algebra defines an  $N$ -coloring of  $S^2$  ( $S^2$ ) which is however not the same thing as the 2-coloring possible for the planar operad. TGD based view about Higgs mechanism leads to a decomposition of partonic 2-surface  $X^2$  (its light-like orbit  $X^3$ ) into conformal patches. Since also these decompositions correspond to effective discretizations of  $X^2$  ( $X^3$ ), these two decompositions would naturally correspond to each other.

2. In SKM sector disk  $D^2$  of the planar disk operad is replaced with the partonic 2-surface  $X^2$  and since measurement resolution is a local notion, the topology of  $X^2$  does not matter. The improvement of measurement resolution corresponds to the replacement of braid strand with braid and homomorphism is to the direction of improved spatial resolution.
3. In super-symplectic case  $D^2$  is replaced with the sphere  $S^2$  of light-cone boundary. The improvement of measurement resolution corresponds to introducing points near the original point and the homomorphism maps field to its average. For the operad of generalized Feynman diagrams  $CD$  defined by future and past directed light-cones is the basic object. Given  $CD$  can be indeed mapped to sphere  $S^2$  in a natural manner. The light-like boundaries of  $CD$ s are metrically spheres  $S^2$ . The points of light-cone boundaries can be projected to any sphere at light-cone boundary. Since the symplectic area of the sphere corresponds to solid angle, the choice of the representative for  $S^2$  does not matter. The sphere defined by the intersection of future and past light-cones of  $CD$  however provides a natural identification of points associated with positive and negative energy parts of the state as points of the same sphere. The points of  $S^2$  appearing in  $n$ -point function are replaced by point sets in a small disks around the  $n$  points.
4. In both super-symplectic and SKM sectors light-like geodesic along  $X^3$  mediate the analog of the map gluing smaller disk to a hole of a disk in the case of planar disk operad defining the decomposition of planar tangles. In super-symplectic sector the set of points at the sphere corresponding to a sub- $CD$  is mapped by SKM braid to the larger  $CD$  and for a typical braid corresponds to a larger angular span at sub- $CD$ . This corresponds to the gluing of  $D^2$  along its boundaries to a hole in  $D^2$  in disk operad. A scaling transformation allowed by the conformal invariance is in question. This scaling can have a non-trivial effect if the conformal fields have anomalous scaling dimensions.
5. Homomorphisms between the algebraic structures assignable to the basic structures of the operad (say tangles in the case of planar tangle operad) are an essential part of the power of the operad. These homomorphisms associated with super-symplectic and SKM sector code for two views about improvement of measurement resolution and might lead to a highly unique construction of M-matrix elements.

The operad picture gives good hopes of understanding how M-matrices corresponding to a hierarchy of measurement resolutions can be constructed using only discrete data.

1. In this process the  $n$ -point function defining M-matrix element is replaced with a superposition of  $n$ -point functions for which the number of points is larger:  $n \rightarrow \sum_{k=1, \dots, m} n_k$ . The numbers  $n_k$  vary in the superposition. The points are also obtained by downwards scaling from those of smaller  $S^2$ . Similar scaling accompanies the composition of tangles in the case of planar disk operad. Algebra homomorphism property gives constraints on the compositeness and should govern to a high degree how the improved measurement resolution affects the amplitude. In the lowest order approximation the M-matrix element is just an  $n$ -point function for conformal fields of positive and negative energy parts of the state at this sphere and one would obtain ordinary stringy amplitude in this approximation.

2. Zero energy ontology means also that each addition in principle brings in a new zero energy insertion as the resolution is improved. Zero energy insertions describe actual physical processes in shorter scales in principle affecting the outcome of the experiment in longer time scales. Since zero energy states can interact with positive (negative) energy particles, zero energy insertions are not completely analogous to vacuum bubbles and cannot be neglected. In an idealized experiment these zero energy states can be assumed to be absent. The homomorphism property must hold true also in the presence of the zero energy insertions. Note that the Feynman graph operad reduces to planar disk operad in absence of zero energy insertions.

## 7.7 Possible other applications of category theory

It is not difficult to imagine also other applications of category theory in TGD framework.

### 7.7.1 Categorification and finite measurement resolution

I read a very stimulating article by John Baez with title Categorification [?] about the basic ideas behind a process called categorification. The process starts from sets consisting of elements. In the following I describe the basic ideas and propose how categorification could be applied to realize the notion of finite measurement resolution in TGD framework.

#### What categorification is?

In categorification sets are replaced with categories and elements of sets are replaced with objects. Equations between elements are replaced with isomorphisms between objects: the right and left hand sides of equations are not the same thing but only related by an isomorphism so that they are not tautologies anymore. Functions between sets are replaced with functors between categories taking objects to objects and morphisms to morphisms and respecting the composition of morphisms. Equations between functions are replaced with natural isomorphisms between functors, which must satisfy certain coherence laws representable in terms of commuting diagrams expressing conditions such as commutativity and associativity.

The isomorphism between objects represents equation between elements of set replaces identity. What about isomorphisms themselves? Should also these be defined only up to an isomorphism of isomorphism? And what about functors? Should one continue this replacement ad infinitum to obtain a hierarchy of what might be called n-categories, for which the process stops after n:th level. This rather fuzzy business is what mathematicians like John Baez are actually doing.

#### Why categorification?

There are good motivations for the categorification. Consider the fact that natural numbers. Mathematically oriented person would think number '3' in terms of an abstract set theoretic axiomatization of natural numbers. One could also identify numbers as a series of digits. In the real life the representations of three-ness are more concrete involving many kinds of associations. For a child '3' could correspond to three fingers. For a mystic it could correspond to holy trinity. For a Christian "faith, hope, love". All these representations are isomorphic representation of threeness but as real life objects three sheep and three cows are not identical.

We have however performed what might be called decategorification: that is forgotten that the isomorphic objects are not equal. Decategorification was of course a stroke of mathematical genius with enormous practical implications: our information society represents all kinds of things in terms of numbers and simulates successfully the real world using only bit sequences. The dark side is that treating people as mere numbers can lead to a rather cold society.

Equally brilliant stroke of mathematical genius is the realization that isomorphic objects are not equal. Decategorization means a loss of information. Categorification brings back this information by bringing in consistency conditions known as coherence laws and finding these laws is the hard part of categorization meaning discovery of new mathematics. For instance, for braid groups commutativity modulo isomorphisms defines a highly non-trivial coherence law leading to an extremely powerful notion of quantum group having among other things applications in topological quantum computation.

The so called associahedrons [?] emerging in  $n$ -category theory could replace space-time and space as fundamental objects. Associahedrons are polygons used to represent geometrically associativity or its weaker form modulo isomorphism for the products of  $n$  objects bracketed in all possible manners. The polygon defines a hierarchy containing sub-polygons as its edges containing.... Associativity states the isomorphy of these polygons. Associahedrons and related geometric representations of category theoretical arrow complexes in terms of simplexes allow a beautiful geometric realization of the coherence laws. One could perhaps say that categories as discrete structures are not enough: only by introducing the continuum allowing geometric representations of the coherence laws things become simple.

No-one would have proposed categorification unless it were demanded by practical needs of mathematics. In many mathematical applications it is obvious that isomorphism does not mean identity. For instance, in homotopy theory all paths deformable to each other in continuous manner are homotopy equivalent but not identical. Isomorphism is now homotopy. These paths can be connected and form a groupoid. The outcome of the groupoid operation is determined up to homotopy. The deformations of closed path starting from a given point modulo homotopies form homotopy group and one can interpret the elements of homotopy group as copies of the point which are isomorphic. The replacement of the space with its universal covering makes this distinction explicit. One can form homotopies of homotopies and continue this process ad infinitum and obtain in this manner homotopy groups as characterizes of the topology of the space.

### Categorification as a manner to describe finite measurement resolution?

In quantum physics gauge equivalence represents a standard example about equivalence modulo isomorphisms which are now gauge transformations. There is a practical strategy to treat the situation: perform a gauge choice by picking up one representative amongst infinitely many isomorphic objects. At the level of natural numbers a very convenient gauge fixing would correspond the representation of natural number as a sequence of decimal digits rather than image of three cows.

In TGD framework a excellent motivation for categorification is the need to find an elegant mathematical realization for the notion of finite measurement resolution. Finite measurement resolutions (or cognitive resolutions) at various levels of information transfer hierarchy imply accumulation of uncertainties. Consider as a concrete example uncertainty in the determination of basic parameters of a mathematical model. This uncertainty is reflected to final outcome as via a long sequence of mathematical maps and additional uncertainties are produced by the approximations at each step of this process.

How could one describe the finite measurement resolution elegantly in TGD Universe? Categorification suggests a natural method. The points equivalent with measurement resolution are isomorphic with each other. A natural guess inspired by gauge theories is that one should perform a gauge choice as an analog of decategorification. This allows also to avoid continuum of objects connected by arrows not in spirit with the discreteness of category theoretical approach.

1. At space-time level gauge choice means discretization of partonic 2-surfaces replacing them with a discrete set points serving as representatives of equivalence classes of points equivalent under finite measurement resolution. An especially interesting choice of points is as rational points or algebraic numbers and emerges naturally in  $p$ -adicization process. One can also introduce what I have called symplectic triangulation of partonic 2-surfaces with the nodes of the triangulation representing the discretization and carrying quantum numbers of various kinds.
2. At the level of "world classical worlds" (WCW) this means the replacement of the sub-group if the symplectic group of  $\delta M^4 \times CP_2$  -call it  $G$  - permuting the points of the symplectic triangulation with its discrete subgroup obtained as a factor group  $G/H$ , where  $H$  is the normal subgroup of  $G$  leaving the points of the symplectic triangulation fixed. One can also consider subgroups of the permutation group for the points of the triangulation. One can also consider flows with these properties to get braided variant of  $G/H$ . It would seem that one cannot regard the points of triangulation as isomorphic in the category theoretical sense. This because, one can have quantum superpositions of states located at these points and the factor group acts as the analog of isometry group. One can also have many-particle states with quantum numbers at several points. The possibility to assign quantum numbers to a given point becomes the physical counterpart for the axiom of choice.

The finite measurement resolution leads to a replacement of the infinite-dimensional world of classical points with a discrete structure. Therefore operation like integration over entire "world of classical worlds" is replaced with a discrete sum.

3. What suggests itself strongly is a hierarchy of n-categories as a proper description for the finite measurement resolution. The increase of measurement resolution means increase for the number of braid points. One has also braids of braids of braids structure implied by the possibility to map infinite primes, integers, and rationals to rational functions of several variables and the conjecture possibility to represent the hierarchy of Galois groups involved as symplectic flows. If so the hierarchy of n-categories would correspond to the hierarchy of infinite primes having also interpretation in terms of repeated second quantization of an arithmetic SUSY such that many particle states of previous level become single particle states of the next level.

The finite measurement resolution has also a representation in terms of inclusions of hyperfinite factors of type  $II_1$  defined by the Clifford algebra generated by the gamma matrices of WCW [K82]

1. The included algebra represents finite measurement resolution in the sense that its action generates states which are cannot be distinguished from each other within measurement resolution used. The natural conjecture is that this indistinguishability corresponds to a gauge invariance for some gauge group and that TGD Universe is analogous to Turing machine in that almost any gauge group can be represented in terms of finite measurement resolution.
2. Second natural conjecture inspired by the fact that symplectic groups have enormous representable power is that these gauge symmetries allow representation as subgroups of the symplectic group of  $\delta M^4 \times CP_2$ . A nice article about universality of symplectic groups is the article The symplectification of science by Mark. J. Gotay [?].
3. An interesting question is whether there exists a finite-dimensional space, whose symplectomorphisms would allow a representation of any gauge group (or of all possible Galois groups as factor groups) and whether  $\delta M^4 \times CP_2$  could be a space of this kind with the smallest possible dimension.

### 7.7.2 Inclusions of HFFs and planar tangles

Finite index inclusions of HFFs are characterized by non-branched planar algebras for which only an even number of lines can emanate from a given disk. This makes possible a consistent coloring of the k-tangle by black and white by painting the regions separated by a curve using opposite colors. For more general algebras, also for possibly existing branched tangle algebras, the minimum number of colors is four by four-color theorem. For the description of zero energy states the 2-color assumption is not needed so that the necessity to have general branched planar algebras is internally consistent. The idea about the inclusion of positive energy state space into the space of negative energy states might be consistent with branched planar algebras and the requirement of four colors since this inclusion involves also conjugation and is thus not direct.

In [?] it was proposed that planar operads are associated with conformal field theories at sphere possessing defect lines separating regions with different color. In TGD framework and for branched planar algebras these defect lines would correspond to light-like 3-surfaces. For fermions one has single wormhole throat associated with topologically condensed  $CP_2$  type extremal and the signature of the induced metric changes at the throat. Bosons correspond to pairs of wormhole throats associated with wormhole contacts connecting two space-time sheets modellable as a piece of  $CP_2$  type extremal. Each boson thus corresponds to 2 lines within  $CP_2$  radius so that in purely bosonic case the planar algebra can correspond to that associated with an inclusion of HFFs.

### 7.7.3 2-plectic structures and TGD

Chris Rogers and Alex Hoffnung have demonstrated [?] that the notion of symplectic structure generalizes to n-plectic structure and in  $n = 2$  case leads to a categorification of Lie algebra to 2-Lie-algebra. In this case the generalization replaces the closed symplectic 2-form with a closed 3-form  $\omega$  and assigns to a subset of one-forms defining generalized Hamiltonians vector fields leaving the 3-form invariant.



There are two equivalent definitions of the Poisson bracket in the sense that these Poisson brackets differ only by a gradient, which does not affect the vector field assignable to the Hamiltonian one-form. The first bracket is simply the Lie-derivate of Hamiltonian one form  $G$  with respect to vector field assigned to  $F$ . Second bracket is contraction of Hamiltonian one-forms with the three-form  $\omega$ . For the first variant Jacobi identities hold true but Poisson bracket is antisymmetric only modulo gradient. For the second variant Jacobi identities hold true only modulo gradient but Poisson bracket is antisymmetric. This modulo property is in accordance with category theoretic thinking in which commutativity, associativity, antisymmetry,... hold true only up to isomorphism.

For 3-dimensional manifolds  $n=2$ -plectic structure has the very nice property that *all* one-forms give rise to Hamiltonian vector field. In this case any 3-form is automatically closed so that a large variety of 2-plectic structures exists. In TGD framework the natural choice for the 3-form  $\omega$  is as Chern-Simons 3-form defined by the projection of the Kähler gauge potential to the light-like 3-surface. Despite the fact the induced metric is degenerate, one can deduce the Hamiltonian vector field associated with the one-form using the general defining conditions

$$i_{v_F}\omega = dF \quad (7.7.1)$$

since the vanishing of the metric determinant appearing in the formal definition cancels out in the expression of the Hamiltonian vector field.

The explicit formula is obtained by writing  $\omega$  as

$$\begin{aligned} \omega &= K\epsilon_{\alpha\beta\gamma} \times \epsilon^{\mu\nu\delta} A_\mu J_{\nu\delta} \sqrt{g} = \epsilon_{\alpha\beta\gamma} \times C - S, \\ C - S &= KE^{\alpha\beta\gamma} A_\alpha J_{\beta\gamma}. \end{aligned} \quad (7.7.2)$$

Here  $E^{\alpha\beta\gamma} = \epsilon_{\alpha\beta\gamma}$  holds true numerically and metric determinant, which vanishes for light-like 3-surfaces, has disappeared.

The Hamiltonian vector field is the curl of  $F$  divided by the Chern-Simons action density  $C - S$ :

$$v_F^\alpha = \frac{1}{2} \times \frac{\epsilon^{\alpha\beta\gamma} (\partial_\beta F_\gamma - \partial_\gamma F_\beta) \sqrt{g}}{C - S \sqrt{g}} = \frac{1}{2} \times \frac{E^{\alpha\beta\gamma} (\partial_\beta F_\gamma - \partial_\gamma F_\beta)}{C - S}. \quad (7.7.3)$$

The Hamiltonian vector field multiplied by the dual of 3-form multiplied by the metric determinant has a vanishing divergence and is analogous to a vector field generating volume preserving flow. and the value of Chern Simons 3-form defines the analog of the metric determinant for light-like 3-surfaces. The generalized Poisson bracket for Hamiltonian 1-forms defined in terms of the action of Hamiltonian vector field on Hamiltonian as  $J_1^\beta D_\beta F_2 \alpha - J_2^\beta D_\beta H_2 \alpha$  is Hamiltonian 1-form. Here  $J_i$  denotes the Hamiltonian vector field associated with  $F_i$ . The bracketed unique apart from gradient. The corresponding vector field is the commutator of the Hamiltonian vector fields.

The objection is that gauge invariance is broken since the expression for the vector field assigned to the Hamiltonian one-form depends on gauge. In TGD framework there is no need to worry since Kähler gauge potential has unique natural expression and the  $U(1)$  gauge transformations of Kähler gauge potential induced by symplectic transformations of  $CP_2$  are not genuine gauge transformations but dynamical symmetries since the induced metric changes and space-time surface is deformed. Another important point is that Kähler gauge potential for a given CD has  $M^4$  part which is "pure gauge" constant Lorentz invariant vector and proportional to the inverse of gravitational constant  $G$ . Its ratio to  $CP_2$  radius squared is determined from electron mass by p-adic mass calculations and mathematically by quantum criticality fixing also the value of Kähler coupling strength.

#### 7.7.4 TGD variant for the category nCob

John Baez has suggested that quantum field theories could be formulated as functors from the category of n-cobordisms to the category of Hilbert spaces [?, ?]. In TGD framework light-like 3-surfaces containing the number theoretical braids define the analogs of 3-cobordisms and surface property brings in new structure. The motion of topological condensed 3-surfaces along 4-D space-time sheets brings in non-trivial topology analogous to braiding and not present in category nCob.

Intuitively it seems possible to speak about one-dimensional orbits of wormhole throats and -contacts (fermions and bosons) in background space-time (homological dimension). In this case linking or knotting are not possible since knotting is co-dimension 2 phenomenon and only objects whose homological dimensions sum up to  $D - 1$  can get linked in dimension  $D$ . String like objects could topologically condense along wormhole contact which is string like object. The orbits of closed string like objects are homologically co-dimension 2 objects and could get knotted if one does not allow space-time sheets describing un-knotting. The simplest examples are ordinary knots which are not allowed to evolve by forming self intersections. The orbits of point like wormhole contact and closed string like wormhole contact can get linked: a point particle moving through a closed string is basic dynamical example. There is no good reason preventing unknotting and unlinking in absolute sense.

### 7.7.5 Number theoretical universality and category theory

Category theory might be also a useful tool to formulate rigorously the idea of number theoretical universality and ideas about cognition. What comes into mind first are functors real to p-adic physics and vice versa. They would be obtained by composition of functors from real to rational physics and back to p-adic physics or vice versa. The functors from real to p-adic physics would provide cognitive representations and the reverse functors would correspond to the realization of intentional action. The functor mapping real 3-surface to p-adic 3-surfaces would be simple: interpret the equations of 3-surface in terms of rational functions with coefficients in some algebraic extension of rationals as equations in arbitrary number field. Whether this description applies or is needed for 4-D space-time surface is not clear.

At the Hilbert space level the realization of these functors would be quantum jump in which quantum state localized to p-adic sector tunnels to real sector or vice versa. In zero energy ontology this process is allowed by conservation laws even in the case that one cannot assign classical conserved quantities to p-adic states (their definition as integrals of conserved currents does not make sense since definite integral is not a well-defined concept in p-adic physics). The interpretation would be in terms of generalized M-matrix applying to cognition and intentionality. This M-matrix would have values in the field of rationals or some algebraic extension of rationals. Again a generalization of Connes tensor product is suggestive.

### 7.7.6 Category theory and fermionic parts of zero energy states as logical deductions

Category theory has natural applications to quantum and classical logic and theory of computation [?] . In TGD framework these applications are very closely related to quantum TGD itself since it is possible to identify the positive and negative energy pieces of fermionic part of the zero energy state as a pair of Boolean statements connected by a logical deduction, or rather- quantum superposition of them. An alternative interpretation is as rules for the behavior of the Universe coded by the quantum state of Universe itself. A further interpretation is as structures analogous to quantum computation programs with internal lines of Feynman diagram would represent communication and vertices computational steps and replication of classical information coded by number theoretical braids.

### 7.7.7 Category theory and hierarchy of Planck constants

Category theory might help to characterize more precisely the proposed geometric realization of the hierarchy of Planck constants explaining dark matter as phases with non-standard value of Planck constant. The situation is topologically very similar to that encountered for generalized Feynman diagrams. Singular coverings and factor spaces of  $M^4$  and  $CP_2$  are glued together along 2-D manifolds playing the role of object and space-time sheets at different vertices could be interpreted as arrows going through this object.

# Mathematics

- [A1] Gaussian Mersenne. <http://primes.utm.edu/glossary/xpage/GaussianMersenne.html>.
- [A2] Z. I. Borevich and I. R. Shafarevich. *Number Theory*. Academic Press, 1966.
- [A3] Eisenhart. *Riemannian Geometry*. Princeton University Press, 1964.
- [A4] C. N. Pope G. W. Gibbons.  $CP_2$  as gravitational instanton. *Comm. Math. Phys.*, 55, 1977.
- [A5] W. Hawking, S. and N. Pope, C. Generalized Spin Structures in Quantum Gravity. *Phys. Lett.*, (1), 1978.
- [A6] S. Helgason. *Differential Geometry and Symmetric Spaces*. Academic Press, New York, 1962.
- [A7] C. Itzykson and J-B. Zuber. *Quantum Field Theory*, volume 549. Mc Graw-Hill, New York, 1980.
- [A8] J. Milnor. *Topology form Differential Point of View*. The University Press of Virginia, Virginia, 1965.
- [A9] D. S. Moak. The q-analogue of the Laguerre polynomials. *J. Math. Anal. Appl.*, 81, 1981.
- [A10] N. Pope, C. Eigenfunctions and  $Spin^c$  Structures on  $CP_2$ , 1980.
- [A11] B. Shipman. The geometry of momentum mappings on generalized flag manifolds, connections with a dynamical system, quantum mechanics and the dance of honeybee. <http://math.cornell.edu/~oliver/Shipman.gif>, 1998.
- [A12] M. Spivak. *Differential Geometry I,II,III,IV*. Publish or Perish, Boston, 1970.
- [A13] J. Hanson T. Eguchi, B. Gilkey. *Phys. Rep.*, 66:1980, 1980.
- [A14] R. Thom. *Commentarii Math. Helvet.*, 28, 1954.
- [A15] Wallace. *Differential Topology*. W. A. Benjamin, New York, 1968.
- [A16] E. C. Zeeman. *Catastrophe Theory*. Addison-Wessley Publishing Company, 1977.



# Books related to TGD

- [K1] M. Pitkänen. 1983.
- [K2] M. Pitkänen. Is it Possible to Understand Coupling Constant Evolution at Space-Time Level? In *Towards M-Matrix*. Onlinebook. [http://tgdtheory.com/public\\_html/tgdquant/tgdquant.html#rgflow](http://tgdtheory.com/public_html/tgdquant/tgdquant.html#rgflow), 2006.
- [K3] M. Pitkänen. About Strange Effects Related to Rotating Magnetic Systems . In *TGD and Fringe Physics*. Onlinebook. [http://tgdtheory.com/public\\_html/freenergy/freenergy.html#Faraday](http://tgdtheory.com/public_html/freenergy/freenergy.html#Faraday), 2006.
- [K4] M. Pitkänen. About the New Physics Behind Qualia. In *Quantum Hardware of Living Matter*. Onlinebook. [http://tgdtheory.com/public\\_html/bioware/bioware.html#newphys](http://tgdtheory.com/public_html/bioware/bioware.html#newphys), 2006.
- [K5] M. Pitkänen. An Overview about Quantum TGD: Part I. In *Topological Geometrodynamics: Overview*. Onlinebook. [http://tgdtheory.com/public\\_html/tgdview/tgdview.html#evoII](http://tgdtheory.com/public_html/tgdview/tgdview.html#evoII), 2006.
- [K6] M. Pitkänen. An Overview about the Evolution of Quantum TGD. In *Topological Geometrodynamics: Overview*. Onlinebook. [http://tgdtheory.com/public\\_html/tgdview/tgdview.html#evoI](http://tgdtheory.com/public_html/tgdview/tgdview.html#evoI), 2006.
- [K7] M. Pitkänen. Anomalies Related to the Classical  $Z^0$  Force and Gravitation. In *TGD and Fringe Physics*. Onlinebook. [http://tgdtheory.com/public\\_html/freenergy/freenergy.html#Zanom](http://tgdtheory.com/public_html/freenergy/freenergy.html#Zanom), 2006.
- [K8] M. Pitkänen. Appendix A: Quantum Groups and Related Structures. In *Towards M-Matrix*. Onlinebook. [http://tgdtheory.com/public\\_html/tgdquant/tgdquant.html#bialgebra](http://tgdtheory.com/public_html/tgdquant/tgdquant.html#bialgebra), 2006.
- [K9] M. Pitkänen. Basic Extremals of Kähler Action. In *Physics in Many-Sheeted Space-Time*. Onlinebook. [http://tgdtheory.com/public\\_html/tgdclass/tgdclass.html#class](http://tgdtheory.com/public_html/tgdclass/tgdclass.html#class), 2006.
- [K10] M. Pitkänen. *Bio-Systems as Conscious Holograms*. Onlinebook. [http://tgdtheory.com/public\\_html/hologram/hologram.html](http://tgdtheory.com/public_html/hologram/hologram.html), 2006.
- [K11] M. Pitkänen. Bio-Systems as Conscious Holograms. In *Bio-Systems as Conscious Holograms*. Onlinebook. [http://tgdtheory.com/public\\_html/hologram/hologram.html#hologram](http://tgdtheory.com/public_html/hologram/hologram.html#hologram), 2006.
- [K12] M. Pitkänen. *Bio-Systems as Self-Organizing Quantum Systems*. Onlinebook. [http://tgdtheory.com/public\\_html/bioselforg/bioselforg.html](http://tgdtheory.com/public_html/bioselforg/bioselforg.html), 2006.
- [K13] M. Pitkänen. Bio-Systems as Super-Conductors: part I. In *Quantum Hardware of Living Matter*. Onlinebook. [http://tgdtheory.com/public\\_html/bioware/bioware.html#superc1](http://tgdtheory.com/public_html/bioware/bioware.html#superc1), 2006.
- [K14] M. Pitkänen. Bio-Systems as Super-Conductors: part II. In *Quantum Hardware of Living Matter*. Onlinebook. [http://tgdtheory.com/public\\_html/bioware/bioware.html#superc2](http://tgdtheory.com/public_html/bioware/bioware.html#superc2), 2006.
- [K15] M. Pitkänen. Configuration Space Spinor Structure. In *Quantum Physics as Infinite-Dimensional Geometry*. Onlinebook. [http://tgdtheory.com/public\\_html/tgdgeom/tgdgeom.html#cspin](http://tgdtheory.com/public_html/tgdgeom/tgdgeom.html#cspin), 2006.

- [K16] M. Pitkänen. Construction of elementary particle vacuum functionals. In *p-Adic Length Scale Hypothesis and Dark Matter Hierarchy*. Onlinebook. [http://tgdtheory.com/public\\_html/paddark/paddark.html#elvafu](http://tgdtheory.com/public_html/paddark/paddark.html#elvafu), 2006.
- [K17] M. Pitkänen. Construction of Quantum Theory: M-matrix. In *Towards M-Matrix*. Onlinebook. [http://tgdtheory.com/public\\_html/tgdquant/tgdquant.html#towards](http://tgdtheory.com/public_html/tgdquant/tgdquant.html#towards), 2006.
- [K18] M. Pitkänen. Cosmic Strings. In *Physics in Many-Sheeted Space-Time*. Onlinebook. [http://tgdtheory.com/public\\_html/tgdclass/tgdclass.html#cstrings](http://tgdtheory.com/public_html/tgdclass/tgdclass.html#cstrings), 2006.
- [K19] M. Pitkänen. Crop Circles and Life at Parallel Space-Time Sheets. In *Magnetospheric Consciousness*. Onlinebook. [http://tgdtheory.com/public\\_html/magnconsc/magnconsc.html#crop1](http://tgdtheory.com/public_html/magnconsc/magnconsc.html#crop1), 2006.
- [K20] M. Pitkänen. Crop Circles and Life at Parallel Space-Time Sheets. In *Magnetospheric Consciousness*. Onlinebook. [http://tgdtheory.com/public\\_html/magnconsc/magnconsc.html#crop2](http://tgdtheory.com/public_html/magnconsc/magnconsc.html#crop2), 2006.
- [K21] M. Pitkänen. Dark Forces and Living Matter. In *p-Adic Length Scale Hypothesis and Dark Matter Hierarchy*. Onlinebook. [http://tgdtheory.com/public\\_html/paddark/paddark.html#darkforces](http://tgdtheory.com/public_html/paddark/paddark.html#darkforces), 2006.
- [K22] M. Pitkänen. Dark Matter Hierarchy and Hierarchy of EEGs. In *TGD and EEG*. Onlinebook. [http://tgdtheory.com/public\\_html/tgdeeg/tgdeeg.html#eegdark](http://tgdtheory.com/public_html/tgdeeg/tgdeeg.html#eegdark), 2006.
- [K23] M. Pitkänen. Dark Nuclear Physics and Condensed Matter. In *p-Adic Length Scale Hypothesis and Dark Matter Hierarchy*. Onlinebook. [http://tgdtheory.com/public\\_html/paddark/paddark.html#exonuclear](http://tgdtheory.com/public_html/paddark/paddark.html#exonuclear), 2006.
- [K24] M. Pitkänen. DNA as Topological Quantum Computer. In *Genes and Memes*. Onlinebook. [http://tgdtheory.com/public\\_html/genememe/genememe.html#dnatqc](http://tgdtheory.com/public_html/genememe/genememe.html#dnatqc), 2006.
- [K25] M. Pitkänen. Does TGD Predict the Spectrum of Planck Constants? In *Towards M-Matrix*. Onlinebook. [http://tgdtheory.com/public\\_html/tgdquant/tgdquant.html#Planck](http://tgdtheory.com/public_html/tgdquant/tgdquant.html#Planck), 2006.
- [K26] M. Pitkänen. Evolution in Many-Sheeted Space-Time. In *Genes and Memes*. Onlinebook. [http://tgdtheory.com/public\\_html/genememe/genememe.html#prebio](http://tgdtheory.com/public_html/genememe/genememe.html#prebio), 2006.
- [K27] M. Pitkänen. General Ideas about Many-Sheeted Space-Time: Part I. In *Physics in Many-Sheeted Space-Time*. Onlinebook. [http://tgdtheory.com/public\\_html/tgdclass/tgdclass.html#topcond](http://tgdtheory.com/public_html/tgdclass/tgdclass.html#topcond), 2006.
- [K28] M. Pitkänen. General Theory of Qualia. In *Bio-Systems as Conscious Holograms*. Onlinebook. [http://tgdtheory.com/public\\_html/hologram/hologram.html#qualia](http://tgdtheory.com/public_html/hologram/hologram.html#qualia), 2006.
- [K29] M. Pitkänen. *Genes and Memes*. Onlinebook. [http://tgdtheory.com/public\\_html/genememe/genememe.html](http://tgdtheory.com/public_html/genememe/genememe.html), 2006.
- [K30] M. Pitkänen. Genes and Memes. In *Genes and Memes*. Onlinebook. [http://tgdtheory.com/public\\_html/genememe/genememe.html#genememec](http://tgdtheory.com/public_html/genememe/genememe.html#genememec), 2006.
- [K31] M. Pitkänen. Homeopathy in Many-Sheeted Space-Time. In *Bio-Systems as Conscious Holograms*. Onlinebook. [http://tgdtheory.com/public\\_html/hologram/hologram.html#homeoc](http://tgdtheory.com/public_html/hologram/hologram.html#homeoc), 2006.
- [K32] M. Pitkänen. Macro-Temporal Quantum Coherence and Spin Glass Degeneracy. In *Bio-Systems as Conscious Holograms*. Onlinebook. [http://tgdtheory.com/public\\_html/hologram/hologram.html#macro](http://tgdtheory.com/public_html/hologram/hologram.html#macro), 2006.
- [K33] M. Pitkänen. Macroscopic Quantum Coherence and Quantum Metabolism as Different Sides of the Same Coin. In *Bio-Systems as Conscious Holograms*. Onlinebook. [http://tgdtheory.com/public\\_html/hologram/hologram.html#metab](http://tgdtheory.com/public_html/hologram/hologram.html#metab), 2006.

- [K34] M. Pitkänen. Macroscopic Quantum Phenomena and  $CP_2$  Geometry. In *Physics in Many-Sheeted Space-Time*. Onlinebook. [http://tgdtheory.com/public\\_html/tgdclass/tgdclass.html#super](http://tgdtheory.com/public_html/tgdclass/tgdclass.html#super), 2006.
- [K35] M. Pitkänen. Magnetic Sensory Canvas Hypothesis. In *TGD and EEG*. Onlinebook. [http://tgdtheory.com/public\\_html//tgdeeg/tgdeeg/tgdeeg.html#mec](http://tgdtheory.com/public_html//tgdeeg/tgdeeg/tgdeeg.html#mec), 2006.
- [K36] M. Pitkänen. *Magnetospheric Consciousness*. Onlinebook. [http://tgdtheory.com/public\\_html/magnconsc/magnconsc.html](http://tgdtheory.com/public_html/magnconsc/magnconsc.html), 2006.
- [K37] M. Pitkänen. Magnetospheric Sensory Representations. In *Magnetospheric Consciousness*. Onlinebook. [http://tgdtheory.com/public\\_html/magnconsc/magnconsc.html#srepress](http://tgdtheory.com/public_html/magnconsc/magnconsc.html#srepress), 2006.
- [K38] M. Pitkänen. Many-Sheeted DNA. In *Genes and Memes*. Onlinebook. [http://tgdtheory.com/public\\_html/genememe/genememe.html#genecodec](http://tgdtheory.com/public_html/genememe/genememe.html#genecodec), 2006.
- [K39] M. Pitkänen. Massless states and particle massivation. In *p-Adic Length Scale Hypothesis and Dark Matter Hierarchy*. Onlinebook. [http://tgdtheory.com/public\\_html/paddark/paddark.html#mless](http://tgdtheory.com/public_html/paddark/paddark.html#mless), 2006.
- [K40] M. Pitkänen. *Mathematical Aspects of Consciousness Theory*. Onlinebook. [http://tgdtheory.com/public\\_html/mathconsc/mathconsc.html](http://tgdtheory.com/public_html/mathconsc/mathconsc.html), 2006.
- [K41] M. Pitkänen. Matter, Mind, Quantum. In *TGD Inspired Theory of Consciousness*. Onlinebook. [http://tgdtheory.com/public\\_html/tgdconsc/tgdconsc.html#conscic](http://tgdtheory.com/public_html/tgdconsc/tgdconsc.html#conscic), 2006.
- [K42] M. Pitkänen. Negentropy Maximization Principle. In *TGD Inspired Theory of Consciousness*. Onlinebook. [http://tgdtheory.com/public\\_html/tgdconsc/tgdconsc.html#nmpc](http://tgdtheory.com/public_html/tgdconsc/tgdconsc.html#nmpc), 2006.
- [K43] M. Pitkänen. New Particle Physics Predicted by TGD: Part I. In *p-Adic Length Scale Hypothesis and Dark Matter Hierarchy*. Onlinebook. [http://tgdtheory.com/public\\_html/paddark/paddark.html#mass4](http://tgdtheory.com/public_html/paddark/paddark.html#mass4), 2006.
- [K44] M. Pitkänen. Nuclear String Hypothesis. In *p-Adic Length Scale Hypothesis and Dark Matter Hierarchy*. Onlinebook. [http://tgdtheory.com/public\\_html/paddark/paddark.html#nuclstring](http://tgdtheory.com/public_html/paddark/paddark.html#nuclstring), 2006.
- [K45] M. Pitkänen. *p-Adic length Scale Hypothesis and Dark Matter Hierarchy*. Onlinebook. [http://tgdtheory.com/public\\_html/paddark/paddark.html](http://tgdtheory.com/public_html/paddark/paddark.html), 2006.
- [K46] M. Pitkänen. p-Adic Particle Massivation: Hadron Masses. In *p-Adic Length Scale Hypothesis and Dark Matter Hierarchy*. Onlinebook. [http://tgdtheory.com/public\\_html/paddark/paddark.html#mass3](http://tgdtheory.com/public_html/paddark/paddark.html#mass3), 2006.
- [K47] M. Pitkänen. p-Adic Physics as Physics of Cognition and Intention. In *TGD Inspired Theory of Consciousness*. Onlinebook. [http://tgdtheory.com/public\\_html/tgdconsc/tgdconsc.html#cognic](http://tgdtheory.com/public_html/tgdconsc/tgdconsc.html#cognic), 2006.
- [K48] M. Pitkänen. *Physics in Many-Sheeted Space-Time*. Onlinebook. [http://tgdtheory.com/public\\_html/tgdclass/tgdclass.html](http://tgdtheory.com/public_html/tgdclass/tgdclass.html), 2006.
- [K49] M. Pitkänen. Quantum Antenna Hypothesis. In *Quantum Hardware of Living Matter*. Onlinebook. [http://tgdtheory.com/public\\_html/bioware/bioware.html#tubuc](http://tgdtheory.com/public_html/bioware/bioware.html#tubuc), 2006.
- [K50] M. Pitkänen. Quantum Astrophysics. In *Physics in Many-Sheeted Space-Time*. Onlinebook. [http://tgdtheory.com/public\\_html/tgdclass/tgdclass.html#qastro](http://tgdtheory.com/public_html/tgdclass/tgdclass.html#qastro), 2006.
- [K51] M. Pitkänen. Quantum Control and Coordination in Bio-systems: Part I. In *Bio-Systems as Self-Organizing Quantum Systems*. Onlinebook. [http://tgdtheory.com/public\\_html/bioselforg/bioselforg.html#qcococI](http://tgdtheory.com/public_html/bioselforg/bioselforg.html#qcococI), 2006.
- [K52] M. Pitkänen. Quantum Control and Coordination in Bio-Systems: Part II. In *Bio-Systems as Self-Organizing Quantum Systems*. Onlinebook. [http://tgdtheory.com/public\\_html/bioselforg/bioselforg.html#qcococII](http://tgdtheory.com/public_html/bioselforg/bioselforg.html#qcococII), 2006.

- [K53] M. Pitkänen. *Quantum Hardware of Living Matter*. Onlinebook. [http://tgdtheory.com/public\\_html/bioware/bioware.html](http://tgdtheory.com/public_html/bioware/bioware.html), 2006.
- [K54] M. Pitkänen. Quantum Model for Hearing. In *TGD and EEG*. Onlinebook. [http://tgdtheory.com/public\\_html//tgdeeg/tgdeeg/tgdeeg.html#hearing](http://tgdtheory.com/public_html//tgdeeg/tgdeeg/tgdeeg.html#hearing), 2006.
- [K55] M. Pitkänen. Quantum Model for Nerve Pulse. In *TGD and EEG*. Onlinebook. [http://tgdtheory.com/public\\_html//tgdeeg/tgdeeg/tgdeeg.html#pulse](http://tgdtheory.com/public_html//tgdeeg/tgdeeg/tgdeeg.html#pulse), 2006.
- [K56] M. Pitkänen. Quantum Model for Paranormal Phenomena. In *TGD Inspired Theory of Consciousness*. Onlinebook. [http://tgdtheory.com/public\\_html/tgdconsc/tgdconsc.html#parac](http://tgdtheory.com/public_html/tgdconsc/tgdconsc.html#parac), 2006.
- [K57] M. Pitkänen. Quantum Model for Sensory Representations. In *TGD Inspired Theory of Consciousness*. Onlinebook. [http://tgdtheory.com/public\\_html/tgdconsc/tgdconsc.html#expc](http://tgdtheory.com/public_html/tgdconsc/tgdconsc.html#expc), 2006.
- [K58] M. Pitkänen. Quantum Model of EEG. In *TGD and EEG*. Onlinebook. [http://tgdtheory.com/public\\_html/tgdeeg/tgdeeg.html#eegII](http://tgdtheory.com/public_html/tgdeeg/tgdeeg.html#eegII), 2006.
- [K59] M. Pitkänen. Quantum Model of Memory. In *TGD Inspired Theory of Consciousness*. Onlinebook. [http://tgdtheory.com/public\\_html/tgdconsc/tgdconsc.html#memoryc](http://tgdtheory.com/public_html/tgdconsc/tgdconsc.html#memoryc), 2006.
- [K60] M. Pitkänen. *Quantum Physics as Infinite-Dimensional Geometry*. Onlinebook. [http://tgdtheory.com/public\\_html/tgdgeom/tgdgeom.html](http://tgdtheory.com/public_html/tgdgeom/tgdgeom.html), 2006.
- [K61] M. Pitkänen. *Quantum TGD*. Onlinebook. [http://tgdtheory.com/public\\_html/tgdquant/tgdquant.html](http://tgdtheory.com/public_html/tgdquant/tgdquant.html), 2006.
- [K62] M. Pitkänen. Quantum Theory of Self-Organization. In *Bio-Systems as Self-Organizing Quantum Systems*. Onlinebook. [http://tgdtheory.com/public\\_html/bioselforg/bioselforg.html#selforgac](http://tgdtheory.com/public_html/bioselforg/bioselforg.html#selforgac), 2006.
- [K63] M. Pitkänen. Semi-trance, Mental Illness, and Altered States of Consciousness. In *Magnetospheric Consciousness*. Onlinebook. [http://tgdtheory.com/public\\_html/magnconsc/magnconsc.html#semitrancec](http://tgdtheory.com/public_html/magnconsc/magnconsc.html#semitrancec), 2006.
- [K64] M. Pitkänen. Semitrance, Language, and Development of Civilization. In *Magnetospheric Consciousness*. Onlinebook. [http://tgdtheory.com/public\\_html/magnconsc/magnconsc.html#langsoc](http://tgdtheory.com/public_html/magnconsc/magnconsc.html#langsoc), 2006.
- [K65] M. Pitkänen. TGD and Astrophysics. In *Physics in Many-Sheeted Space-Time*. Onlinebook. [http://tgdtheory.com/public\\_html/tgdclass/tgdclass.html#astro](http://tgdtheory.com/public_html/tgdclass/tgdclass.html#astro), 2006.
- [K66] M. Pitkänen. TGD and Cosmology. In *Physics in Many-Sheeted Space-Time*. Onlinebook. [http://tgdtheory.com/public\\_html/tgdclass/tgdclass.html#cosmo](http://tgdtheory.com/public_html/tgdclass/tgdclass.html#cosmo), 2006.
- [K67] M. Pitkänen. *TGD and EEG*. Onlinebook. [http://tgdtheory.com/public\\_html/tgdeeg/tgdeeg.html](http://tgdtheory.com/public_html/tgdeeg/tgdeeg.html), 2006.
- [K68] M. Pitkänen. *TGD and Fringe Physics*. Onlinebook. [http://tgdtheory.com/public\\_html/freenergy/freenergy.html](http://tgdtheory.com/public_html/freenergy/freenergy.html), 2006.
- [K69] M. Pitkänen. TGD and Nuclear Physics. In *p-Adic Length Scale Hypothesis and Dark Matter Hierarchy*. Onlinebook. [http://tgdtheory.com/public\\_html/paddark/paddark.html#padnucl](http://tgdtheory.com/public_html/paddark/paddark.html#padnucl), 2006.
- [K70] M. Pitkänen. *TGD as a Generalized Number Theory*. Onlinebook. [http://tgdtheory.com/public\\_html/tgdnumber/tgdnumber.html](http://tgdtheory.com/public_html/tgdnumber/tgdnumber.html), 2006.
- [K71] M. Pitkänen. TGD as a Generalized Number Theory: p-Adicization Program. In *TGD as a Generalized Number Theory*. Onlinebook. [http://tgdtheory.com/public\\_html/tgdnumber/tgdnumber.html#visiona](http://tgdtheory.com/public_html/tgdnumber/tgdnumber.html#visiona), 2006.



- [K72] M. Pitkänen. TGD as a Generalized Number Theory: Quaternions, Octonions, and their Hyper Counterparts. In *TGD as a Generalized Number Theory*. Onlinebook. [http://tgdtheory.com/public\\_html/tgdnumber/tgdnumber.html#visionb](http://tgdtheory.com/public_html/tgdnumber/tgdnumber.html#visionb), 2006.
- [K73] M. Pitkänen. TGD Based Model for OBEs. In *TGD Inspired Theory of Consciousness*. Onlinebook. [http://tgdtheory.com/public\\_html/tgdconsc/tgdconsc.html#OBE](http://tgdtheory.com/public_html/tgdconsc/tgdconsc.html#OBE), 2006.
- [K74] M. Pitkänen. *TGD Inspired Theory of Consciousness*. Onlinebook. [http://tgdtheory.com/public\\_html/tgdconsc/tgdconsc.html](http://tgdtheory.com/public_html/tgdconsc/tgdconsc.html), 2006.
- [K75] M. Pitkänen. TGD Inspired Theory of Consciousness. In *Topological Geometrodynamics: Overview*. Onlinebook. [http://tgdtheory.com/public\\_html/tgdview/tgdview.html#tgdconsc2010](http://tgdtheory.com/public_html/tgdview/tgdview.html#tgdconsc2010), 2006.
- [K76] M. Pitkänen. The Notion of Free Energy and Many-Sheeted Space-Time Concept. In *TGD and Fringe Physics*. Onlinebook. [http://tgdtheory.com/public\\_html/freenergy/freenergy.html#freenergy](http://tgdtheory.com/public_html/freenergy/freenergy.html#freenergy), 2006.
- [K77] M. Pitkänen. The Relationship Between TGD and GRT. In *Physics in Many-Sheeted Space-Time*. Onlinebook. [http://tgdtheory.com/public\\_html/tgdclass/tgdclass.html#tgdgrt](http://tgdtheory.com/public_html/tgdclass/tgdclass.html#tgdgrt), 2006.
- [K78] M. Pitkänen. Three new physics realizations of the genetic code and the role of dark matter in bio-systems. In *Genes and Memes*. Onlinebook. [http://tgdtheory.com/public\\_html/genememe/genememe.html#dnatqccodes](http://tgdtheory.com/public_html/genememe/genememe.html#dnatqccodes), 2006.
- [K79] M. Pitkänen. Time, Spacetime and Consciousness. In *Bio-Systems as Conscious Holograms*. Onlinebook. [http://tgdtheory.com/public\\_html/hologram/hologram.html#time](http://tgdtheory.com/public_html/hologram/hologram.html#time), 2006.
- [K80] M. Pitkänen. *Topological Geometrodynamics: an Overview*. Onlinebook. [http://tgdtheory.com/public\\_html/tgdview/tgdview.html](http://tgdtheory.com/public_html/tgdview/tgdview.html), 2006.
- [K81] M. Pitkänen. Topological Quantum Computation in TGD Universe. In *Genes and Memes*. Onlinebook. [http://tgdtheory.com/public\\_html/genememe/genememe.html#tqc](http://tgdtheory.com/public_html/genememe/genememe.html#tqc), 2006.
- [K82] M. Pitkänen. Was von Neumann Right After All. In *Towards M-Matrix*. Onlinebook. [http://tgdtheory.com/public\\_html/tgdquant/tgdquant.html#vNeumann](http://tgdtheory.com/public_html/tgdquant/tgdquant.html#vNeumann), 2006.
- [K83] M. Pitkänen. Wormhole Magnetic Fields. In *Quantum Hardware of Living Matter*. Onlinebook. [http://tgdtheory.com/public\\_html/bioware/bioware.html#wormc](http://tgdtheory.com/public_html/bioware/bioware.html#wormc), 2006.



# Articles about TGD

- [L1] M. Pitkänen. Macro-temporal quantum coherence, quantum spin glass degeneracy, and number theoretic information concept. <http://www.emergentmind.org/journal.htm>, 2003.
- [L2] M. Pitkänen. Time, Space-Time, and Consciousness. <http://www.emergentmind.org/journal.htm>, 2003.
- [L3] M. Pitkänen. Further Progress in Nuclear String Hypothesis. <http://tgdtheory.com/articles/nuclstring.pdf>, 2007.
- [L4] M. Pitkänen. TGD based solution of Fermi paradox. <http://www.physics.helsinki.fi/~matpitka/articles/fermieng.pdf>, 2007.



Part III

**TWISTORS, BOSONIC  
EMERGENCE, SPACE-TIME  
SUPERSYMMETRY**



## Chapter 8

# Twistors, $N = 4$ Super-Conformal Symmetry, and Quantum TGD

### 8.1 Introduction

Twistors - a notion discovered by Penrose [?] - have provided a fresh approach to the construction of perturbative scattering amplitudes in Yang-Mills theories and in  $N = 4$  supersymmetric Yang-Mills theory. This approach was pioneered by Witten [?] . The latest step in the progress was the proposal by Nima Arkani-Hamed and collaborators [?] that super Yang Mills and super gravity amplitudes might be formulated in 8-D twistor space possessing real metric signature  $(4, 4)$ . The questions considered below are following.

1. Could twistor space provide a natural realization of  $N = 4$  super-conformal theory requiring critical dimension  $D = 8$  and signature metric  $(4, 4)$ ? Could string like objects in TGD sense be understood as strings in twistor space? More concretely, could one in some sense lift quantum TGD from  $M^4 \times CP_2$  to 8-D twistor space  $T$  so that one would have three equivalent descriptions of quantum TGD.
2. Could one construct the preferred extremals of Kähler action in terms of twistors -may be by mimicking the construction of hyper-quaternionic *resp.* co-hyper-quaternionic surfaces in  $M^8$  as surfaces having hyper-quaternionic tangent space *resp.* normal space at each point with the additional property that one can assign to each point  $x$  a plane  $M^2(x) \subset M^4$  as sub-space or as sub-space defined by light-like tangent vector in  $M^4$ . Could one mimic this construction by assigning to each point of  $X^4$  regarded as a 4-surface in  $T$  a 4-D plane of twistor space satisfying some conditions making possible the interpretation as a tangent plane and guaranteeing the existence of a map of  $X^4$  to a surface in  $M^4 \times CP_2$ . Could twistor formalism help to resolve the integrability conditions involved?
3. Could one define 8-D counterpart of twistors in order to avoid the problems posed by the description of massive states by regarding them as massless states in 8-D context. Could the octonionic realization of 8-D gamma matrices allow to define twistors in 8-D framework? Could associativity constraint reducing twistors to quaternionic twistors locally imply effective reduction to four-dimensional twistors.
4. Are 8-D counterparts of twistors needed at all? Could the reduction of the dynamics to that for 4-D surfaces and effective 2-dimensionality have twistorial counterparts in the sense that 4-D twistors or their suitable generalization or even 2-D twistors could make sense at the fundamental level? Number theoretical vision based on the requirement of not only associativity but also of commutativity would suggest a reduction to  $M^2$ -valued momenta having description in terms of 2-D twistors. The preferred  $M^2 \subset M^4$  identified as hyper-complex plane plays also a key role in the realization of the zero energy ontology and hierarchy of Planck constants.

The arguments of this chapter suggest that some these questions might have affirmative answers. It must be of course emphasized that all considerations are highly speculative first thoughts of an

innocent novice. The proposals to be discussed do not form a single coherent picture but are just alternatives between which one might choose in the lack of anything better. In the next chapter [?] a proposal for the realization of twistor program inspired by the Yangian symmetry [?] to the twistor Grassmannian program [?] and looks much more realistic. I have however decided to keep this chapter as a document about the development of ideas.

### 8.1.1 Twistors and classical TGD

Consider first the twistorialization at the classical space-time level.

1. One can assign twistors to only 4-D Minkowski space (also to other than Lorentzian signature). One of the challenges of the twistor program is how to define twistors in the case of a general curved space-time. In TGD framework the structure of the imbedding space allows to circumvent this problem.
2. The lifting of classical TGD to twistor space level is a natural idea. Consider space-time surfaces representable as graphs of maps  $M^4 \rightarrow CP_2$ . At classical level the Hamilton-Jacobi structure [K9] required by the number theoretic compactification means dual slicings of the  $M^4$  projection of the space-time surface  $X^4$  by stringy world sheets and partonic two-surfaces. Stringy slicing allows to assign to each point of the projection of  $X^4$  two light-like tangent vectors  $U$  and  $V$  parallel to light-like Hamilton-Jacobi coordinate curves. These vectors define components  $\tilde{\mu}$  and  $\lambda$  of a projective twistor, and twistor equation assigns to this pair a point  $m$  of  $M^4$ . The conjecture is that for preferred extremals of Kähler action this point corresponds to the  $M^4$  projection of the point in the natural  $M^4$  coordinates associated with the upper or lower tip of causal diamond  $CD$ . If this conjecture is correct one can lift the  $M^4$  projection of the space-time surface in  $CD \times CP_2 \subset M^4 \times CP_2$  to a surface in  $PT \times CP_2$ , where  $CP_3$  is projective twistor space  $PT = CP_3$ . Also induced spinor fields and induced gauge fields can be lifted to twistor space.
3. If one can fix the scales of the tangent vectors  $U$  and  $V$  and fix the phase of spinor  $\lambda$  one can consider also the lifting to 8-D twistor space  $T$  rather than 6-D projective twistor space  $PT$ . Kind of symmetry breaking would be in question. The proposal for how to achieve this relies on the notion of finite measurement resolution. The scale of  $V$  at partonic 2-surface  $X^2 \subset \delta CD \times X_l^3$  would naturally correlate with the energy of the massless particle assignable to the light-like curve beginning from that point and thus fix the scale of  $V$  coordinate. Symplectic triangulation discussed in [?] in turn allows to assign a phase factor to each strand of the number theoretic braid as the Kähler magnetic flux associated with the triangle having the point at its center. This allows to lift the stringy world sheets associated with number theoretic braids to their twistor variants but not the entire space-time surface. String model in twistor space is obtained in accordance with the fact that  $N = 4$  super-conformal invariance is realized as a string model in a target space with  $(4, 4)$  signature of metric. Note however that  $CP_2$  defines additional degrees of freedom for the target space so that 12-D space is actually in question.
4. One can consider also a more general problem of identifying the counterparts for the preferred extremals of Kähler action with arbitrary dimensions of  $M^4$  and  $CP_2$  projections in 10-D space  $PT \times CP_2$ . The key idea is the reduction of field equations to holomorphy as in Penrose's twistor representation of solutions of positive and negative frequency parts of free fields in  $M^4$ . A very helpful observation is that  $CP_2$  as a sub-manifold of  $PT$  corresponds to the 2-D space of null rays of the complexified Minkowski space  $M_c^4$ . For the 5-D space  $N \subset PT$  of null twistors this 2-D space contains 1-dimensional light ray in  $M^4$  so that  $N$  parameterizes the light-rays of  $M^4$ . The idea is to consider holomorphic surfaces in  $PT_{\pm} \times CP_2$  ( $\pm$  correlates with positive and negative energy parts of zero energy state) having dimensions  $D = 6, 8, 10$ ; restrict them to  $N \times CP_2$ , select a sub-manifold of light-rays from  $N$ , and select from each light-ray subset of points which can be discrete or portion of the light-ray in order to get a 4-D space-time surface. If integrability conditions for the resulting distribution of light-like vectors  $U$  and  $V$  can be satisfied (in other words they are gradients), a good candidate for a preferred extremal of Kähler action is obtained. Note that this construction raises light-rays to a role of fundamental geometric object.



### 8.1.2 Twistors and Feynman diagrams

The recent successes of twistor concept in the understanding of 4-D gauge theories and  $N = 4$  SYM motivate the question of how twistorialization could help to understand construction of  $M$ -matrix in terms of Feynman diagrammatics or its generalization.

1. One of the basic problems of twistor program is how to treat massive particles. Massive four-momentum can be described in terms of two twistors but their choice is uniquely only modulo  $SO(3)$  rotation. This is ugly and one can consider several cures to the situation.
  - (a) Number theoretic compactification and hierarchy of Planck constants leading to a generalization of the notion of imbedding space assign to each sector of configuration space defined by a particular  $CD$  a unique plane  $M^2 \subset M^4$  defining quantization axes. The line connecting the tips of the  $CD$  selects also unique rest frame (time axis). The representation of a light-like four-momentum as a sum of four-momentum in this plane and second light-like momentum is unique and same is true for the spinors  $\lambda$  apart from the phase factors (the spinor associated with  $M^2$  corresponds to spin up or spin down eigen state).
  - (b) The tangent vectors of braid strands define light-like vectors in  $H$  and their  $M^4$  projection is time-like vector allowing a representation as a combination of  $U$  and  $V$ . Could also massive momenta be represented as unique combinations of  $U$  and  $V$ ?
  - (c) One can consider also the possibility to represent massive particles as bound states of massless particles.

It will be found that one can lift ordinary Feynman diagrams to spinor diagrams and integrations over loop momenta correspond to integrations over the spinors characterizing the momentum.

2. One assign to ordinary momentum eigen states spinor  $\lambda$  but it is not clear how to identify the spinor  $\tilde{\mu}$  needed for a twistor.
  - (a) Could one assign  $\tilde{\mu}$  to spin polarization or perhaps to the spinor defined by the light-like  $M^2$  part of the massive momentum? Or could  $\lambda$  and  $\tilde{\mu}$  correspond to the vectors proportional to  $V$  and  $U$  needed to represent massive momentum?
  - (b) Or is something more profound needed? The notion of light-ray is central for the proposed construction of preferred extremals. Should momentum eigen states be replaced with light ray momentum eigen states with a complete localization in degrees of freedom transversal to light-like momentum? This concept is favored both by the notion of number theoretic braid and by the massless extremals (MEs) representing "topological light rays" as analogs of laser beams and serving as space-time correlates for photons represented as wormhole contacts connecting two parallel MEs. The transversal position of the light ray would bring in  $\tilde{\mu}$ . This would require a modification of the perturbation theory and the introduction of the ray analog of Feynman propagator. This generalization would be  $M^4$  counterpart for the highly successful twistor diagrammatics relying on twistor Fourier transform but making sense only for the (2,2) signature of Minkowski space.

### 8.1.3 Massive particles and the generalization of twistors to 8-D case

The basic problem of the twistor approach is that one cannot represent massive momenta in terms of twistors in elegant manner. This problem might be circumvented.

1. In quantum TGD massive states in  $M^4$  can be regarded as massless states in  $M^8$  and  $CP_2$  (recall  $M^8 - H$  duality), and one can map any massive  $M^4$  momentum to a light-like  $M^8$  momentum and hope that this association could be made in a unique manner.
2. One should assign to a massless 8-momentum an 8-dimensional spinor of fixed chirality. The spinor assigned with the light-like four-momentum is not unique without additional conditions. The existence of covariantly constant right-handed neutrino in  $CP_2$  degrees generating the super-conformal symmetries could allow to eliminate the non-uniqueness. 8-dimensional twistor in  $M^8$  would be a pair of this kind of spinors fixing the momentum of massless particle and the point

through which the corresponding light-geodesic goes through: the set of these points forms 8-D light-cone and one can assign to each point a spinor. In  $M^4 \times CP_2$  definitions makes also in the case of  $M^4 \times CP_2$  and twistor space would also now be a lifting of the space of light-like geodesics.

3. The possibility to interpret  $M^8$  as hyperoctonionic space suggests also the possibility to define the 8-D counterparts of sigma matrices to hyperoctonions to obtain a representation of sigma matrix algebra which is not a matrix representation. The mapping of gamma matrices to this representation allows to define a notion of hyper-quaternionicity in terms of the modified gamma matrices both in  $M^8$  and  $H$ . In this case however hyper-quaternionic 4-plane associated with a given point of  $X^4$  is not tangent plane in the general case. This approach allows to deduce an ansatz to the modified Dirac equation working also in the general case.

### 8.1.4 Twistors and electric-magnetic duality

The vision involves the notions of bosonic emergence, the identification of virtual states as pairs of on mass shell states assignable to wormhole throats inspired by zero energy ontology and the associated realization of Cutkosky rules in terms of manifestly finite Feynman diagrammatics, and as the latest and most important piece the weak form of electric-magnetic duality and the notion of  $M^2$ -valued pseudo-momentum associated with the generalized eigen states of the Chern-Simons Dirac operator. There must be a correlation between pseudo-momenta and real momenta and the identification of the difference of pseudo-momenta of wormhole throats representing virtual particle as the difference of corresponding on-mass-shell momenta is what gives a connection between ordinary virtual momenta and pseudo-momenta. One would obtain not only 4-D twistors but much simpler 2-D twistors with a discrete pseudo-momentum spectrum containing possibly only a finite number of momenta.

To sum up, the ideas about twistors are just ideas and it takes years to transform them to a genuine theory. At this moment the simplest and most promising approach is the one inspired by zero energy ontology combined with the implications of electric-magnetic duality and the combination of this approach with the twistor Grassmannian program discussed in the next chapter looks much more realistic than the considerations of this chapter.

## 8.2 Could the target space be identified in terms of twistors?

The problem of quantum theory in  $(2, 2)$  signature and corresponding real twistors is that a spacetime with this metric signature does not conform with the standard view about causality. The challenge is to find a physical interpretation consistent with the metric signature of Minkowski space: somehow  $M^4$  or at least light-cone boundary should be lifted to twistor space. The  $(2,2)$  *resp.*  $(4,4)$  signature of the metric of the target space is a problem of also  $N = 2$  *resp.*  $N = 4$  super-conformal string theories, and  $N = 4$  super-conformal string theory could be relevant for quantum TGD since TGD has  $N = 4$  superconformal symmetries as broken symmetries. The identification of the target space of  $N = 4$  theory as twistor space  $T$  looks natural.

Number theoretical compactification implies dual slicings of the space-time surface to string world sheets and partonic 2-surfaces. Finite measurement resolution reduces light-like 3-surfaces to braids defining boundaries of string world sheets. String model in  $T$  is obtained if one can lift the string world sheets from  $CD \times CP_2$  to  $T$ . It turns out that this is possible and one can also find an interpretation for the phases associated with the spinors defining the twistor.

A physically attractive realization of the braids - and more generally- of slicings of space-time surface by 3-surfaces and string world sheets, is discussed in [?] by starting from the observation that TGD defines an almost topological QFT of braids, braid cobordisms, and 2-knots. The boundaries of the string world sheets at the space-like 3-surfaces at boundaries of  $CD$ s and wormhole throats would define space-like and time-like braids uniquely.

The idea relies on a rather direct translation of the notions of singular surfaces and surface operators used in gauge theory approach to knots [?] to TGD framework. It leads to the identification of slicing by three-surfaces as that induced by the inverse images of  $r = \text{constant}$  surfaces of  $CP_2$ , where  $r$  is  $U(2)$  invariant radial coordinate of  $CP_2$  playing the role of Higgs field vacuum expectation value in gauge theories.  $r = \infty$  surfaces correspond to geodesic spheres and define analogs of fractionally magnetically charged Dirac strings identifiable as preferred string world sheets. The union of these

sheets labelled by subgroups  $U(2) \subset SU(3)$  would define the slicing of space-time surface by string world sheets. The choice of  $U(2)$  relates directly to the choice of quantization axes for color quantum numbers characterizing  $CD$  and would have the choice of braids and string world sheets as a space-time correlate.

### 8.2.1 General remarks

Some remarks are in order before considering a detailed proposal for how to achieve the above described goal.

1. Penrose ends up with the notion of twistor by expressing Pauli-Lubanski vector and four-momentum vector of massless particle in terms of two spinors and their conjugates. Twistor  $Z^A$  consists of a pair  $(\tilde{\mu}^{\dot{a}}, \lambda_a)$  of spinors in representations  $(1/2, 0)$  and  $(0, 1/2)$  of Lorentz group. The antisymmetric tensor  $\epsilon^{ab}$  defines Kähler form in the space of 2-spinors and  $i\epsilon^{ab}$  defines Kähler metric which reduces to the  $(1, 1, -1, -1)$  diagonal form in real representation. The hermitian matrix defined by the tensor product of  $\lambda_{\dot{a}}$  and its conjugate characterizes the four-momentum of massless particle in the representation  $p^a \sigma_a$  using Pauli's sigma matrices. In Penrose's original approach  $\tilde{\mu}^{\dot{a}}$  characterizes the angular momentum of the particle: spin is given by  $s = Z^\alpha \bar{Z}_\alpha$ . The representation is not unique since  $\lambda_a$  is fixed only apart from a phase factor, which might be called "twist". The phases of two spinors are completely correlated.
2. This interpretation is not equivalent with that discussed mostly in [?] and [?]. Scattering amplitudes are not functions of momenta and polarizations but of a spinor, its conjugate defining light-like momentum, and helicity having values  $\pm 1$ . In Minkowski space with Lorentz signature the momentum as kinematic variable is replaced with spinor and its conjugate and spinor is defined apart from a phase factor. In the latter article the signature of Minkowski space is taken to be  $(2, 2)$  so that the situation changes dramatically. Light rays assignable to twistors are 2-D light-like light-like surfaces and the spinor associated with light-like point decomposes to two independent real spinors replacing light-like momentum as a kinematic variable. The phase factor as an additional kinematic variable is replaced by a real scaling factors  $t$  and  $1/t$  for the two spinors. Fourier transform with respect to the real spinor or its conjugate is possible and gives scattering amplitude as a function of a twistor variable. In Lorentz signature the twistor Fourier transform in this sense is not possible so one cannot replace spinor and its conjugate by a twistor.
3. The space of 2-spinors has a Hermitian metric with real signature  $(2, 2)$  since the Lorentz invariant Hermitian metric  $i\epsilon^{ab}$  has diagonal form  $(1, -1)$  in complex coordinates. Twistors consist of two spinors and the 8-D twistor space -call it  $T$ - has Kähler metric with complex metric signature  $(2, 2)$  and real metric signature  $(4, 4)$ , and could correspond to the target space of  $N = 4$  super-conformally symmetric theory and might define the target space of  $N = 4$  super-conformally symmetric string theory with strings identified as  $T$  lifts of the string world sheets having braid strands at their ends. The minimum requirement is that one can assign to each point of string world sheet a twistor.

### 8.2.2 What twistor Fourier transform could mean in TGD framework?

For the existence of twistor Fourier transform the reality and independence of the spinors  $\lambda$  and  $\tilde{\mu}$  is essential and are satisfied for  $(2, 2)$  signature. In Lorentzian signature these conditions fail. The question is whether TGD framework could allow to construct twistor amplitudes.

1. From Witten's paper [?] one learns that twistor-space scattering amplitudes obtained as Fourier-transforms with respect to the real conjugate spinor in Minkowski space with  $(2, 2)$  signature correspond to incoming and outgoing states for which the wave functions are not plane waves but are located to 2-D sub-spaces of Minkowski space defined by the equation

$$\tilde{\mu}_{\dot{a}} + x_{\dot{a}a} \lambda^a = 0 . \quad (8.2.1)$$

In a more familiar notation one has  $x^\mu \sigma_\mu \lambda = \tilde{\mu}$ . This condition follows directly from twistor Fourier transform.

2. In Lorentz signature similar equation is obtained from Penrose transform relating the solutions of free wave equations for various spins to the elements of sheaf cohomology assignable to projective twistor space (see the appendix of [?]). In this case the solution is unique apart from the shift  $x^\mu \rightarrow x^\mu + k p^\mu$ , where  $p^\mu$  is the light-like momentum associated with  $\lambda$  identified as a solution of massless Dirac equation. Hence twistor corresponds to a wave function localized at light ray.
3. If the equivalent of twistor Fourier transform exists in some sense in Lorentz signature, the geometric interpretation would be as a decomposition of massless plane wave to a superposition of wave functions localized to light-like rays in the direction of momentum. Uncertainty Principle does not deny the existence of this kind of wave functions. These highly singular wave functions would be labeled by momentum and one point at the light ray or equivalently (apart from the phase factor) by  $\lambda_a$  and  $\tilde{\mu}^{\dot{a}}$  defining the twistor. The wave functions would be constant at the rays and thus wave functions in a 3-dimensional sub-manifold of  $M^4$  labeling the light rays. This sub-manifold could be taken light-cone boundary as is easy to see so that the overlap of wave function with different direction of 3-momentum would take place only at the tip of the light-cone. Fields in twistor space would be fields in the space of light-rays characterized by a wave vector.
4. Light-likeness fixes  $x$  and  $\mu$  for given  $\lambda$  uniquely if one assumes that  $\mu$  is in the plane  $M^2$  defined by  $\lambda$  and thus light-like dual of the momentum vector satisfying  $x \cdot p = -1$ . Clearly, momentum conservation gives to conservation of  $x$  and one can interpret  $x$  as a geometric representation of momentum analogous to the representation momentum increment in X-ray scattering at "heavenly sphere". Quantum classical correspondence encourages to consider at least half seriously this kind of coding of momentum to a position of braid point at light-cone boundary. Since twistor Fourier transform does not work, one must invent some other manner to introduce these wave functions. Here the lifting of space-time surface to twistor space suggests itself.
5. The basic challenge is to assign to space-time surface or to each point of space-time surface a momentum like quantity. If this is achieved one can assign to the point also  $\lambda$  and  $\tilde{\mu}$ .
  - (a) One can assign to space-time sheet a conserved four-momentum identifiable by quantum classical correspondence as its quantal variant. This option would fix  $\lambda$  to be same at each point of the space-time surface about from a possible phase factor depending on space-time point. The resulting surfaces in twistor space would be rather boring.
  - (b) Hamilton-Jacobi coordinates [K9] suggest the possibility of defining  $\lambda$  as a quantity depending on space-time point. The two light-like  $M^4$  coordinates  $u, v$  define preferred coordinates for the string world sheets  $Y^2$  appearing in the slicing of  $X^4(X_i^3)$ , and the light-like tangent vectors  $U$  and  $V$  of these curves define a pair  $(\lambda, \tilde{\mu})$  of spinors defining twistor  $Z$ . The vector  $V$  defining the tangent vector of the braid strand is analogous to four-momentum. Twistor equation defines a point  $m$  of  $M^4$  apart from a shift along the light ray defined by  $V$  and the consistency implying that the construction is not mere triviality is that  $m$  corresponds to the projection of space-time point to  $M^4$  in coordinates having origin at the tip of  $CD$ . One could distinguish between negative and positive energy extremals according to whether the tip is upper or lower one. One can assign to  $\lambda$  and  $\tilde{\mu}$  also two polarization vectors by a standard procedure [?] to be discussed later having identification as tangent vectors of coordinate curves of transversal Hamilton-Jacobi coordinates. This would give additional consistency conditions.
6. In this manner space-time surface representable as a graph of a map from  $M^4$  to  $CP_2$  would be mapped to a 4-surface in twistor space apart from the non-uniqueness related to the phase factor of  $\lambda$ . Also various field quantities, in particular induced spinor fields at space-time surface, could be lifted to fields restricted to a 4-dimensional surface of the twistor space so that the classical dynamics in twistor space would be induced from that in imbedding space.

7. This mapping would induce also a mapping of the string world sheets  $Y^2 \subset P_{M^4}(X^4(X_l^3))$  to twistor space.  $V$  would determine  $\lambda$  and  $U$  -taking the role of light-cone point  $m$  - would determine  $\tilde{\mu}$  in terms of the twistor equation. 2-surfaces in twistor space would be defined as images of the 2-D string world sheets if the integrability of the distribution for  $(U, V)$  pairs implies the integrability of  $(\lambda, \tilde{\mu})$  pairs.
8. Twistor scattering amplitude would describe the scattering of a set of incoming light-rays to a set of outgoing light-rays so that the non-locality of interactions is obvious. Discretization of partonic 2-surfaces to discrete point sets would indeed suggest wave functions localized at light-like rays going through the braid points at the ends of  $X_l^3$  as a proper basis so that problems with Uncertainty Principle would be overcome. The incoming and outgoing twistor braid points would be determined by  $M^4$  projections of the braid points at the ends of  $X_l^3$ . By quantum classical correspondence the conservation law of classical four-momentum would apply to the total classical four-momentum although for individual braid strands classical four-momenta would not be conserved. The interpretation would be in terms of interactions. The orbits of stringy curves connecting braid points would give string like objects in  $T$  required by  $N = 4$  super-conformal field theory.

### 8.2.3 Could one define the phase factor of the twistor uniquely?

The proposed construction says nothing about the phase of the spinors assigned to the tangent vectors  $V$  and  $U$ . One can consider two possible interpretations.

1. Since the tangent vectors  $U$  and  $V$  are determined only apart from overall scaling the phase indeterminacy could be interpreted by saying that projective twistors are in question.
2. If one can fix the absolute magnitude of  $U$  and  $V$  -say by fixing the scale of Hamilton Jacobi coordinates by some physical argument- then the map is to twistors and one should be able to fix the phase.

It turns out that the twistor formulation of field equations taking into account also  $CP_2$  degrees of freedom to be discussed later favors the first option. The reason why the following argument deserves a consideration is that it would force braid picture and thus replacement of space-time sheets by string world sheets in twistor formulation.

1. The phase of the spinor  $\lambda_a$  associated with the light-like four-momentum and light-like point of  $\delta M_{\pm}^4$  should represent genuine physical information giving the twistor its "twist". Algebraically twist corresponds to a  $U(1)$  rotation along closed orbit with a physical significance, possibly a gauge rotation. Since the induced  $CP_2$  Kähler form plays a central role in the construction of quantum TGD, the "twist" could correspond to the non-integrable phase factor defined as the exponent of Kähler magnetic flux (to achieve symplectic invariance and thus zero mode property) through an area bounded by some closed curve assignable with the point of braid strand at  $X^2$ . Both  $CP_2$  and  $\delta M_{\pm}^4$  Kähler forms define fluxes of this kind so that two kinds of phase factors are available but  $CP_2$  Kähler flux looks more natural.
2. The symplectic triangulation defined by  $CP_2$  Kähler form allows to identify the closed curve as the triangle defined by the nearest three vertices to which the braid point is connected by edges. Since each point of  $X^4(X_l^3)$  belongs to a unique partonic 2-surface  $X^2$ , this identification can be made for the braid strands contained by any light-like 3-surface  $Y_l^3$  parallel to  $X_l^3$  so that phase factors can be assigned to all points of string world sheets having braid strands as their ends. One cannot assign phases to all points of  $X^4(X_l^3)$ . The exponent of this phase factor is proportional to the coupling of Kähler gauge potential to fermion and distinguishes between quarks and leptons.
3. The phase factor associated with the light-like four-momentum defined by  $V$  could be identified as the non-integrable phase factor defined by -say-  $CP_2$  Kähler form. The basic condition would fix the phase of  $\tilde{\mu}$ . The phases could be permuted but the assignment of  $\delta M_{\pm}^4$  Kähler form with  $m$  is natural. Note that the phases of the twistors are symplectic invariants and not subject to quantum fluctuations in the sense that they would contribute to the line element of the metric of the world of classical worlds. This conforms with the interpretation as kinematical variables.

4. Rather remarkably, this construction can assign the non-integrable phase factor only to the points of the number theoretic braid for each  $Y_l^3$  parallel to  $X_l^3$  so that one obtains only a union of string world sheets in  $T$  rather than lifting of the entire  $X^4(X_l^3)$  to  $T^2$ . The phases of the twistors would code for non-local information about space-time surface coded by the tangent space of  $X^4(X_l^3)$  at the points of string curves.

### 8.3 Could one regard space-time surfaces as surfaces in twistor space?

Twistors are used to construct solutions of free wave equations with given spin and self-dual solutions of both YM theories and Einstein's equations [?]. Twistor analyticity plays a key role in the construction of construction of solutions of free field equations. In General Relativity the problem of the twistor approach is that twistor space does not make sense for a general space-time metric [?]. In TGD framework this problem disappears and one can ask how twistors could possibly help to construct preferred extremals. In particular, one can ask whether it might be possible to interpret space-time surfaces as surfaces - not necessarily four-dimensional - in twistor space.

#### 8.3.1 How $M^4 \times CP_2$ emerges in twistor context?

The finding that  $CP_2$  emerges naturally in twistor space considerations is rather encouraging.

1. Twistor space allows two kinds of 2-planes in complexified  $M^4$  known as  $\alpha$ - and  $\beta$ -planes and assigned to twistor and its dual [?]. This reflects the fundamental duality of the twistor geometry stating that the points  $Z$  of  $PT$  label also complex planes ( $CP_2$ ) of  $PT$  via the condition

$$Z_a W^a = 0 . \quad (8.3.1)$$

To the twistor  $Z$  one can assign via twistor equation complex  $\alpha$ -plane, which contains only null vectors and correspond to the plane defined by the twistors intersecting at  $Z$ .

For null twistors (5-D sub-space  $N$  of  $PT$ ) satisfying  $Z^a \tilde{Z}_a = 0$  and identifiable as the space of light-like geodesics of  $M^4$   $\alpha$ -plane contains single real light-ray.  $\beta$ -planes in turn correspond to dual twistors which define 2-D null plane  $CP_2$  in twistor space via the equation  $Z_a W^a = 0$  and containing the point  $W = \tilde{Z}$ . Since all lines  $CP_1$  of  $CP_2$  intersect, also they parameterize a 2-D null plane of complexified  $M^4$ . The  $\beta$ -planes defined by the duals of null twistors  $Z$  contain single real light-like geodesic and intersection of two  $CP_2$ :s defined by two points of line of  $N$  define  $CP_1$  coding for a point of  $M^4$ .

2. The natural appearance of  $CP_2$  in twistor context suggests a concrete conjecture concerning the solutions of field equations. Light rays of  $M^4$  are in 1-1 correspondence with the 5-D space  $N \subset P$  of null twistors. Compactified  $M^4$  corresponds to the real projective space  $PN$ . The dual of the null twistor  $Z$  defines 2-plane  $CP_2$  of  $PT$ .
3. This suggests the interpretation of the counterpart of  $M^4 \times CP_2$  as a bundle like structure with total space consisting of complex 2-planes  $CP_2$  determined by the points of  $N$ . Fiber would be  $CP_2$  and base space 5-D space of light-rays of  $M^4$ . The fact that  $N$  does not allow holomorphic structure suggests that one should extend the construction to  $PT$  and restrict it to  $N$ . The twistor counterparts of space-time surfaces in  $T$  would be holomorphic surfaces of  $PT \times CP_2$  or possibly of  $PT_{\pm}$  (twistor analogs of lower and upper complex plane and assignable to positive and negative frequency parts of classical and quantum fields) restricted to  $N \times CP_2$ .

#### 8.3.2 How to identify twistorial surfaces in $PT \times CP_2$ and how to map them to $M^4 \times CP_2$ ?

The question is whether and how one could construct the correspondence between the points of  $M^4$  and  $CP_2$  defining space-time surface from a holomorphic correspondence between points of  $PT$  and  $CP_2$  restricted to  $N$ .

1. The basic constraints are that space-time surfaces with varying values for dimensions of  $M^4$  and  $CP_2$  projections are possible and that these surfaces should result by a restriction from  $PT \times CP_2$  to  $N \times CP_2$  followed by a map from  $N$  to  $M^4$  either by selecting some points from the light ray or by identifying entire light rays or their portions as sub-manifolds of  $X^4$ .
2. Quantum classical correspondence would suggest that surfaces holomorphic only in  $PT_+$  or  $PT_-$  should be used so that one could say that positive and negative energy states have space-time correlates. This would mean an analogy with the construction of positive and negative energy solutions of free massless fields. The corresponding space-time surfaces would emerge from the lower and upper light-like boundaries of the causal diamond  $CD$ .
3. A rather general approach is based on an assignment of a sub-manifold of  $CP_2$  to each light ray in  $PT_{\pm}$  in holomorphic manner that is by  $n$  equations of form

$$F_i(\xi^1, \xi^2, Z) = 0, \quad i = 1, \dots, n \leq 2. \quad (8.3.2)$$

The dimension of this kind of surface in  $PT \times CP_2$  is  $D = 10 - 2n$  and equals to 6, 8 or 10 so that a connection or at least analogy with M-theory and branes is suggestive. For  $n = 0$  entire  $CP_2$  is assigned with the point  $Z$  ( $CP_2$  type vacuum extremals with constant  $M^4$  coordinates): this is obviously a trivial case. For  $n = 1$  8-D manifold is obtained. In the case that  $Z$  is expressible as a function of  $CP_2$  coordinates, one could obtain  $CP_2$  type vacuum extremals or their deformations. Cosmic strings could be obtained in the case that there is no  $Z$  dependence. For  $n = 4$  discrete set of points of  $CP_2$  are assigned with  $Z$  and this would correspond to field theory limit, in particular massless extremals. If the dimension of  $CP_2$  projection for fixed  $Z$  is  $n$ , one must construct  $4 - n$ -dimensional subset of  $M^4$  for given point of  $CP_2$ .

4. If one selects a discrete subset of points from each light ray, one must consider a  $4 - n$ -dimensional subset of light rays. The selection of points of  $M^4$  must be carried out in a smooth manner in this set. The light rays of  $M^4$  with given direction can be parameterized by the points of light-cone boundary having a possible interpretation as a surface from which the light rays emerge (boundary of  $CD$ ).
5. One could also select entire light rays or portions of them. In this case a  $4 - n - 1$ -dimensional subset of light rays must be selected. This option could be relevant for the simplest massless extremals representing propagation along light-like geodesics (in a more general case the first option must be considered). The selection of the subset of light rays could correspond to a choice of  $4 - n - 1$ -dimensional sub-manifold of light-cone boundary identifiable as part of the boundary of  $CD$  in this case. In this case one could worry about the intersections of selected light rays. Generically the intersections occur in a discrete set of points of  $H$  so that this problem does not seem to be acute. The lines of generalized Feynman diagrams interpreted as space-time surfaces meet at 3-D vertex surfaces and in this case one must pose the condition that  $CP_2$  projections at the 3-D vertices are identical.
6. The use of light rays as the basic building bricks in the construction of space-time surfaces would be the space-time counterpart for the idea that light ray momentum eigen states are more fundamental than momentum eigen states.

$M^8 - H$  duality is Kähler isometry in the sense that both induced metric and induced Kähler form are identical in  $M^8$  and  $M^4 \times CP_2$  representations of the space-time surface. In the recent case this would mean that the metric induced to the space-time surface by the selection of the subset of light-rays in  $N$  and subsets of points at them has the same property. This might be true trivially in the recent case.

### 8.3.3 How to code the basic parameters of preferred extremals in terms of twistors?

One can proceed by trying to code what is known about preferred extremals to the twistor language.

1. A very large class of preferred extremals assigns to a given point of  $X^4$  two light-like vectors  $U$  and  $V$  of  $M^4$  and two polarization vectors defining the tangent vectors of the coordinate lines of Hamilton-Jacobi coordinates of  $M^4$  [K9]. As already noticed, given null-twistor defines via  $\lambda$  and  $\tilde{\mu}$  two light-like directions  $V$  and  $U$  and twistor equation defines  $M^4$  coordinate  $m$  apart from a shift in the direction of  $V$ . The polarization vectors  $\epsilon_i$  in turn can be defined in terms of  $U$  and  $V$ .  $\lambda = \mu$  corresponds to a degenerate case in which  $U$  and  $V$  are conjugate light-like vectors in plane  $M^2$  and polarization vector is also light-like. This could correspond to the situation for  $CP_2$  type vacuum extremals. For the simplest massless extremals light-like vector  $U$  is constant and the solution depends on  $U$  and transverse polarization  $\epsilon$  vector only. More generally, massless extremals depend only on two  $M^4$  coordinates defined by  $U$  coordinate and the coordinate varying in the direction of local polarization vector  $\epsilon$ .
2. Integrable distribution of these light-like vectors and polarization vectors required. This means that these vectors are gradients of corresponding Hamilton-Jacobi coordinate variables. This poses conditions on the selection of the subset of light rays and the selection of  $M^4$  points at them. Hyper-quaternionic and co-hyper-quaternionic surfaces of  $M^8$  are also defined by fixing an integrable distribution of 4-D tangent planes, which are parameterized by points of  $CP_2$  provided one can assign to the tangent plane  $M^2(x)$  either as a sub-space or via the assignment of light-like tangent vector of  $x$ .
3. Positive (negative) helicity polarization vector [?] can be constructed by taking besides  $\lambda$  arbitrary spinor  $\mu_a$  and defining

$$\epsilon_{a\dot{a}} = \frac{\lambda_a \tilde{\mu}_{\dot{a}}}{[\tilde{\lambda}, \tilde{\mu}]}, \quad [\tilde{\lambda}, \tilde{\mu}] \equiv \epsilon_{\dot{a}b} \lambda^{\dot{a}} \mu^b \quad (8.3.3)$$

for negative helicity and

$$\epsilon_{a\dot{a}} = \frac{\mu_a \tilde{\lambda}_{\dot{a}}}{\langle \lambda, \mu \rangle}, \quad \langle \lambda, \mu \rangle \equiv \epsilon_{ab} \mu^a \lambda^b \quad (8.3.4)$$

for positive helicity. Real polarization vectors correspond to sums and differences of these vectors. In the recent case a natural identification of  $\mu$  would be as the second light-like vector defining point of  $m$ . One should select one light-like vector and one real polarization vector at each point and find the corresponding Hamilton-Jacobi coordinates. These vectors could also code for directions of tangents of coordinate curves in transversal degrees of freedom.

The proposed construction seems to be consistent with the proposed lifting of preferred extremals representable as a graph of some map  $M^4 \rightarrow CP_2$  to surfaces in twistor space. What was done in one variant of the construction was to assign to the light-like tangent vectors  $U$  and  $V$  spinors  $\tilde{\mu}$  and  $\lambda$  assuming that twistor equation gives the  $M^4$  projection  $m$  of the point of  $X^4(X_l^3)$ . This is the inverse of the process carried out in the recent construction and would give  $CP_2$  coordinates as functions of the twistor variable in a 4-D subset of  $N$  determined by the lifting of the space-time surface. The facts that tangent vectors  $U$  and  $V$  are determined only apart from overall scaling factor and the fact that twistor is determined up to a phase, imply that projective twistor space  $PT$  is in question. This excludes the interpretation of the phase of the twistor as a local Kähler magnetic flux. The next steps would be extension to entire  $N$  and a further continuation to holomorphic field in  $PT$  or  $PT_{\pm}$ .

To summarize, although these arguments are far from final or convincing and are bound to reflect my own rather meager understanding of twistors, they encourage to think that twistors are indeed natural approach in TGD framework. If the recent picture is correct, they code only for a distribution of tangent vectors of  $M^4$  projection and one must select both a subset of light rays and a set of  $M^4$  points from each light-ray in order to construct the space-time surface. What remains open is how to solve the integrability conditions and show that solutions of field equations are in question. The possibility to characterize preferred extremal property in terms of holomorphy and integrability conditions would mean analogy with both free field equations in  $M^4$  and minimal surfaces. For known extremals holomorphy in fact guarantees the extremal property.



### 8.3.4 Hyper-quaternionic and co-hyper-quaternionic surfaces and twistor duality

In TGD framework space-time surface decomposes into two kinds of regions corresponding to hyper-quaternionic and co-hyper-quaternionic regions of the space-time surface in  $M^8$  (hyper-quaternionic regions were considered in preceding arguments). The regions of space-time with  $M^4$  (Euclidian) signature of metric are identified tentatively as the counterparts of hyper-quaternionic (co-hyper-quaternionic) space-time regions. Pieces  $CP_2$  type vacuum extremals representing generalized Feynman diagrams and having light-like random curve as  $M^4$  projection represent the basic example here. Also these space-time regions should have any twistorial counterpart and one can indeed assign to  $M^4$  projection of  $CP_2$  type vacuum extremal a spinor  $\lambda$  as its tangent vector and spinor  $\mu$  via twistor equation once  $M^4$  projection is known.

The first guess would be the correspondence hyper-quaternionic  $\leftrightarrow \alpha$  and co-hyper-quaternionic  $\leftrightarrow \beta$ . Previous arguments in turn suggest that hyper-quaternionic space-time surfaces are mapped to surfaces for which two null twistors are assigned with given point of  $M^4$  whereas co-hyper-quaternionic space-time surfaces are mapped to the surfaces for which only single twistor corresponds to a given  $M^4$  point.

## 8.4 Could one lift Feynman diagrams to twistor space?

In [?] the possibility of twistor diagrammatics is considered and it is interesting to look this from TGD perspective where standard beliefs about what quantum theory is must be given up.

1. The arguments start from ordinary momentum space perturbation theory. The amplitudes for the scattering of massless particles are expressed in terms of twistors after which one performs twistor Fourier transform obtaining amazingly simple expressions for the amplitudes. For instance, the 4-point one loop amplitude in N=4 SYM is extremely simple in twistor space having only values '1' and '0' in twistor space and vanishes for generic momenta.
2. Also IR divergences are absent in twistor transform of the scattering amplitude but are generated by the transform to the momentum space. Since plane waves are replaced with light rays, it is not surprising that the IR divergences coming from transversal degrees of freedom are absent. Interestingly, TGD description of massless particles as wormhole throats connecting two massless extremals extends ideal light-ray to massless extremal having finite transversal thickness so that IR cutoff emerges purely dynamically.
3. This approach fails at the level of loops unless one just uses the already calculated loops. The challenge would be a generalization of the ordinary perturbation theory so that loops could be calculated in twistor space formulation.

The vision about lifting TGD from 8-D  $M^4 \times CP_2$  to 8-D twistor space suggests that it should be possible to lift also ordinary  $M^4$  propagators to propagators to twistor space. The first problem is that the momenta of massive virtual particles do not allow any obvious unique representation in terms of twistors. Second problem relates to massive incoming momenta necessarily encountered in stringy picture even if one forgets massivation of light states by p-adic thermodynamics.

### 8.4.1 The treatment of massive case in terms of twistors

Massive incoming momenta and loop momenta are problematic from the point of view of twistor description. TGD suggests two alternative approaches to the problem.

1. One can express arbitrary four-momentum as a sum of two light-like momenta. What makes this representation inelegant is its non-uniqueness. For time-like momentum the two light-like momenta in opposite directions can have any direction so that sphere  $SO(3)/SO(2) = S^2$  labels the degeneracy and for space-like case the degeneracy corresponds to the hyperboloid  $SL(2, R)/SO(2)$  of  $M^3$ . This degeneracy has no obvious physical meaning unless virtual momentum corresponds physically to a pair of light-like momenta which can have also opposite

signs of energy. This would however mean effectively introduction of two light-like loop momenta instead of one and therefore doubling of the loop. A possible interpretation would be as an introduction of an additional braid strand.

2. Also massive particles should be treated in practical approach. The existence of preferred  $M^2 \subset M^4$  forced both by the number theoretic compactification and by the hierarchy of Planck constants would allow to express massive four-momenta uniquely as sums of two light-like momenta, with second momentum in the plane  $M^2$ . This would bring in two twistors with second twistor corresponding to a spin  $\pm 1/2$  spinor depending on the direction of the momentum. Whether it is possible to interpret the momentum in terms of a genuine composition to a state of two massless particles with second particle moving in the preferred plane  $M^2$  remains an open question. This would allow also to treat massive particles by assuming that loop momenta are on shell momenta. For both stringy excitations and particles receiving their mass by p-adic thermodynamics this might be an appropriate approach.
3. From the twistor point of view a more satisfactory description would be the identification of the massive states as bound states of massless fermions associated with braid strands. If braid strands carry light-like momenta which are not parallel, one can obtain massive off mass shell momenta. For conformal excitations it would be natural to assign the action of the Kac-Moody generators and corresponding Virasoro generators creating the state to separate braid strands. In QCD description of hadrons in terms of massless partons this kind of description is of course already applied.
4. A further possibility making sense in massless theories is the restriction of the momenta rotating in loops to be light-like. This idea turned out to be short lived but led to a first quantitatively precise proposal for how QFT like Feynman diagrammatics could emerge from TGD framework.

### 8.4.2 Purely twistorial formulation of Feynman graphs

In the following twistorial formulation of Feynman diagrammatics in TGD framework is considered. If only light-like loop momenta are allowed one can lift the 3-dimensional integral  $d^3k/2E$  appearing in the propagators to an integral over twistor variables, which means that complete twistorialization of Feynman diagrams is possible if the loop integrals involve only light-like momenta. This formulation generalizes to the case when loop momenta are massive but requires the introduction of an auxiliary twistor corresponding to momenta restricted to the preferred plane  $M^2 \subset M^4$  predicted by the number theoretical compactification and hierarchy of Planck constants.

1. It is convenient to introduce double cylindrical coordinates  $\lambda_i = \rho_i \exp(i(\phi \pm \psi))$  in twistor space. The integration over overall phase  $\phi$  gives only a  $2\pi$  factor since ordinary Feynman amplitude has no dependence on this variable so that the non-redundant variables are  $\rho_1, \rho_2, \psi$ .
2. The condition is that the integral measure  $d^4uX$  of the spinor space with a suitable weight function  $X$  is equivalent with the measure  $d^3k/2E$  in cylindrical coordinates. This gives

$$d^4uX = d\phi \frac{d^3k}{2E} \quad (8.4.1)$$

when the integrand does not depend on  $\phi$ .

3. In cylindrical coordinates this gives

$$2\rho_1\rho_2 d\rho_1 d\rho_2 d\psi X \delta(U - k_z) \delta(V - k_x) \delta(W - k_y) = 1, \quad (8.4.2)$$

$$U = \frac{\rho_1^2 - \rho_2^2}{2}, \quad V = \frac{\rho_1 \rho_2 \cos(\psi)}{2}, \quad W = \frac{\rho_1 \rho_2 \sin(\psi)}{2}.$$

Here the functions  $U$ ,  $V$ , and  $W$  are obtained from the representations of  $k_z, k_x, k_y$  in terms of spinor and its conjugate.

4. Taking  $U, V, W$  as integration variables one has

$$2\rho_1\rho_2 \frac{\partial(\rho_1, \rho_2, \psi)}{\partial(U, V, W)} X = 1 \quad . \quad (8.4.3)$$

5. The calculation of the Jacobian gives  $X = (\rho_1^2 + \rho_2^2)/4 = E/2$  so that one has the equivalence

$$\frac{1}{4\pi} d^4u \leftrightarrow \frac{d^3k}{2E} \quad . \quad (8.4.4)$$

6. Similar lifting can be carried out for the integration measure defined at light-cone boundary in  $M^4$ . If the integrations in generalized Feynman diagrams are over amplitudes depending on light-like momenta and coordinates of the light-like boundaries of CDs in given length scales coming as  $T_n = 2^n T_0$  or  $T_p = p T_0$  the integrals of momentum space and light-one can be transformed to integrals over twistor space in given length scale. Twistorialization requirement obviously gives a justification for the basic assumption of zero ontology that all transition amplitudes can be formulated in terms of data at the intersections of light-like 3-surfaces with the boundaries of CDs.

7. It should be emphasized that there is no need to keep the phase angle  $\phi$  as a redundant variable is the interpretation as Kähler magnetic flux is accepted. In fact, Kähler magnetic fluxes are expected to appear as zero modes define external parameters in the amplitudes.

One can carry out similar calculation for  $d^4k$  assuming the representation of  $p$  as a sum of two light-like momenta  $k_1$  and  $k_2$  with another one lying in the preferred plane  $M^2$ . The representation is unique and given by

$$\begin{aligned} p &= k_1 + k \quad , \\ k_1 &= (|p_T| \cosh(\eta), |p_T| \sinh(\eta), p_T) \quad , \quad k = |k|(1, \epsilon, 0, 0) \quad , \quad \epsilon = \pm 1 \quad , \\ \exp(\eta) &= \left[ \frac{|p_T|}{p_0 - \epsilon p_z} \right]^\epsilon \quad , \\ |k| &= p_0 - |p_T| \cosh(\eta) \quad . \end{aligned} \quad (8.4.5)$$

Both signs of  $\epsilon = k_2^0/k_2^z$  are needed and correspond to spin up and spin down spinor  $\mu$  with an indefinite phase whereas  $k_1$  corresponds to  $\lambda$  as in previous example. The 6-dimensional volume element in the space of the spinors is

$$dV = \rho_1 \rho_2 \rho_3 d\rho_1 d\rho_2 d\rho_3 d\Psi d\Phi_1 d\Phi_2 \quad . \quad (8.4.6)$$

$\Phi_1$  and  $\Phi_2$  represent the phases of the spinors  $\lambda$  and  $\mu$  and are redundant variables in the momentum integration. The expression for  $d^4k$  in terms of spinor variables reads as

$$d^4k = \frac{1}{16\pi^2} [\rho_1^2(1 - \epsilon) + \rho_2^2(1 + \epsilon)] \times dV \quad . \quad (8.4.7)$$

Here the redundant integral over  $d\Phi_i$  is included. The integration measure does not have so nice structure as in the case of light-cone. Whether one might combine the spinors to single twistor is an interesting question: conformal invariance does not encourage this. Second option is to combine spinors and their complex conjugates to twistors.

### 8.4.3 What could be the propagator in twistor space?

The mere lifting of Feynman diagrams is probably not enough since the propagator in momentum space corresponds to momentum eigen states whereas in TGD framework a more natural notion is the propagator in the space of light-rays, which correspond to states totally localized in the direction of light-like momentum and thus could be seen as superpositions of momentum eigen states with virtual momentum components in transversal directions so that all momenta would be actually space-like in standard sense. Topological light rays (massless extremals) are the direct space-time correlate for this picture and also braid picture and direct physical intuition about what particles are support the idea about ray propagator.

What could propagation mean assuming that one allows only the propagation of light-like momenta in loops in order to achieve an elegant expression of loop diagrams in terms of spinors  $\lambda$ ?

1. The points of  $M^4$  are effectively replaced with parallel light-rays for given four-momentum and so that it does not make sense to speak about propagation in the direction of light-like four-momentum. Rather, the propagation would be in the space defined by transversal degrees of freedom which can be parameterized by the points of light-cone.  $x$  is fixed uniquely if one assumes it to lie in the plane defined by  $p$  as dual of  $p$  and conservation  $p$  gives rise to conservation of  $x$  with the already suggests interpretation as a geometric representation of momentum. One could construct oscillator operators basis creating light-ray states. The task is to guess an expression for the commutators  $[a^\dagger(p_1, m_1), a(p_2, m_2)]$ .

If one accepts the parametrization of the space of parallel light rays in terms of points  $m_1$  and  $m_2$  of light-cone, one can argue that only the complete overlap of light rays occurring for  $m_1 = m_2$  should contribute to the commutator. This would give

$$[a^\dagger(p_1, m_1), a(p_2, m_2)] = i2E_1 \times 2|m_1^0| \times \delta^3(p_1 - p_2)\delta^3(m_1 - m_2) .$$

This picture is consistent with the classical intuitive picture and also with the idea that signals propagate only along light-rays. In twistor space this would give commutation relations which are completely local and there would be no propagation. Note the complete symmetry between momentum space and x-space.

2. This would give for the counterpart of massless scalar propagator  $G_-$  allowing only the propagation of light-like virtual momenta the expression

$$G_-(p_1, p_2, m_1, m_2) = i\delta^3(p_1 - p_2)\delta^3(m_1 - m_2)4E_1 \times |m_1^0| . \quad (8.4.8)$$

3. From this one can construct the counterpart of  $G_-$  in the twistor space. This would give

$$G_-(\lambda_1, \tilde{\mu}_1, \lambda_2, \tilde{\mu}_2) = i\delta(\lambda_1\tilde{\lambda}_1 - \lambda_2\tilde{\lambda}_2)\delta(\mu_1\tilde{\mu}_1 - \mu_2\tilde{\mu}_2) \times 4E|m_1^0| . \quad (8.4.9)$$

Note that  $m_1$  and therefore also  $m_1^0$  can be fixed uniquely from the basic twistor equation by using the constraint that  $m_1 \equiv x$  is light-like so that one has  $x_{ab} = \mu_a\tilde{\mu}_b$  if  $\mu_a\lambda^a = 1$  is satisfied.

4. One can express the momentum conserving delta function in terms of delta function  $\delta^4(\lambda_1 - \lambda_2)$  if one assumes that the irrelevant phase  $\exp(i\phi)$  of  $\lambda$  (as far as ordinary Feynman diagrams are considered) is conserved. The alternative is the the propagator does not depend at all on the phase difference  $\phi_1 - \phi_2$ . The proposed interpretation of the phase in terms of Kähler magnetic flux which can be interpreted as non-quantum fluctuating zero mode given for all points of braids as classical variable would suggest that it does not make sense to speak about correlation function for  $\phi$  in quantal sense. Going to the cylindrical coordinates  $(\rho_1, \rho_2, \psi, \phi)$  repeating the calculation of the Jacobian for the transformations  $\lambda \rightarrow (\rho_1, \rho_2, \psi, \phi) \rightarrow (k_1, k_2, k_3, \phi)$  and its variant for  $m$  coordinate, one obtains that for massless virtual states the propagator for the two options is apart from normalization constants equal to

$$G_-(\lambda_1, \tilde{\mu}_1, \lambda_2, \tilde{\mu}_2) = i \frac{\delta^4(\lambda_1 - \lambda_2) \delta^4(\tilde{\mu}_1 - \tilde{\mu}_2)}{\delta(\phi_1 - \phi_2) \delta(\phi_1 - \phi_2)}. \quad (8.4.10)$$

The division by  $\delta(\phi_1 - \phi_2)$  symbolizes the assumption of that  $\phi$  is not quantum fluctuating variable. Consider next the twistor counterpart of Feynman propagator

$$G_F(p_1, p_2) = i \delta^4(p_1 - p_2) \frac{1}{p_1^2 + i\epsilon}. \quad (8.4.11)$$

$p_1$  can be expressed as a sum of  $p_1 = p_{1a} + p_{1b}$  of light-like momenta expressible in terms of  $\lambda_{1a}$  and  $\lambda_{2a}$ . One can assign to  $p_{1a}$  and  $p_{1b}$  also light-cone points  $m_{1a}$  and  $m_{1b}$  as their duals and thus also  $\tilde{\mu}_{1\dot{a}}$  and  $\mu_{2\dot{a}}$ . Note that the momentum defined by  $m$  would be conserved and provide a geometric space-time representation for the real momentum.

It is however not clear whether twistor space counterpart of Feynman propagator makes sense. Should one assume that the two light-like momenta propagate independently so that the ray propagator would be proportional to the product of delta functions  $\delta(m_{1a} - m_{2a})\delta(m_{1b} - m_{2b})$  and  $\delta(p_{1a} - p_{2a})\delta(p_{1b} - p_{2b})$ ? These expressions could be translated to delta functions in twistor degrees of freedom just as above and the only difference would be the presence of  $1/p_1^2$  factor. One could perhaps say that effectively the off mass shell particle is a state of two massless particles with correlation between them characterized by the  $1/p_1^2$  factor.

#### 8.4.4 What to do with the perturbation theory?

The basic question is whether one should replace the perturbation theory based on momentum eigenstates with a perturbation theory relying on ray momentum eigen states completely localized in transverse degrees of freedom and allowing only light-like loop momenta or just restrict the loop momenta of ordinary Feynman diagrams to be light-like? Depending on answer to this question one ends up with different scenarios raising further questions.

1. Suppose that one uses ordinary momentum eigen states. The minimum option of the ordinary perturbation theory or of its stringy variant in TGD framework means the replacement of loop momenta with light-like momenta using  $G_-$  instead of  $G_F$ . In this approach spinors  $\lambda$  are enough and one can do without  $\mu$  and  $m$ . One could of course introduce them but  $m$  would be simply the light-like dual of  $p$  in the minimal scenario and completely constrained.
2. If one introduces ray eigen states, then also  $m$  and  $\tilde{\mu}$  emerge naturally. In TGD based perturbation theory  $m$  can be assumed to reside at light-cone boundary (at  $\delta CD$ ). Since braid points at  $X^2$  vary it seems that one must allow  $m$  to be dynamical so that  $\mu$  is also dynamical. If  $m$  and  $p$  are duals then braid points come representatives of momenta and  $m$  and  $\mu$  disappear again from the theory. This hypothesis is however ad hoc and un-necessary. For this option the naive generalization of Feynman diagrammatics is not enough. A possible guess for the generalization has been already proposed.

### 8.5 Could one generalize the notion of twistor to 8-D case?

The basic problem of the twistor approach is that one cannot represent massive momenta in terms of twistors in elegant manner. I have proposed a possible representation of massive states based on the existence of preferred plane of  $M^2$  in the basic definition of theory allowing to express four-momentum as some of two light-like momenta allowing twistor description. One could however ask whether some more elegant representation of massive  $M^4$  momenta might be possible by generalizing the notion of twistor -perhaps by starting from the number theoretic vision.

The basic idea is obvious: in quantum TGD massive states in  $M^4$  can be regarded as massless states in  $M^8$  and  $CP_2$  (recall  $M^8 - H$  duality). One can therefore map any massive  $M^4$  momentum to a light-like  $M^8$  momentum and hope that this association could be made in a unique manner. One should

assign to a massless 8-momentum an 8-dimensional spinor of fixed chirality. The spinor assigned with the light-like four-momentum is not unique without additional conditions. The existence of covariantly constant right-handed neutrino in  $CP_2$  degrees generating the super-conformal symmetries could allow to eliminate the non-uniqueness. 8-dimensional twistor in  $M^8$  would be a pair of this kind of spinors fixing the momentum of massless particle and the point through which the corresponding light-geodesic goes through: the set of these points forms 8-D light-cone and one can assign to each point a spinor. In  $M^4 \times CP_2$  definitions makes also in the case of  $M^4 \times CP_2$  and twistor space would also now be a lifting of the space of light-like geodesics.

The possibility to interpret  $M^8$  as hyperoctonionic space suggests also the possibility to define the 8-D counterparts of sigma matrices to hyperoctonions to obtain a representation of sigma matrix algebra which is not a matrix representation. The mapping of gamma matrices to this representation allows to define a notion of hyper-quaternionicity in terms of the modified gamma matrices both in  $M^8$  and  $H$ .

### 8.5.1 Octo-twistors defined in terms of ordinary spinors

It is possible to define octo-twistors in terms of ordinary spinors of  $M^8$  or  $H$ .

1. The condition for the octo-twistor makes sense also for ordinary spinors and the explicit representation can be obtained by using triality. The ansatz is  $p^k = \bar{\Psi}\gamma^k\Psi$ . The condition  $p^k p_k = 0$  gives Dirac equation  $p^k \gamma_k \Psi = 0$  and its conjugate solved by  $\Psi = p^k \gamma_k \Psi_0$ . The expression of  $p^k$  in turn gives the normalization condition  $\bar{\Psi}_0 \gamma^k p_k \Psi_0 = 1/2$ .
2. Without further conditions almost any  $\Psi_0$  not annihilated by  $\gamma^k p_k$  is possible solution. One can map the spinor basis to hyper-octonion basis and assume  $\Psi_0 \rightarrow 1 = \sigma_0$ . This would give octo-twistor spinors as  $\Psi = p^k \gamma_k \Psi_0$  and its conjugate and there would be natural mapping to  $p^k \sigma_k$  so that  $\Psi$  and  $p^k$  would correspond to each other in 1-1 manner apart from the phase factor of  $\Psi$ .
3. A highly unique choice for  $\Psi_0$  is the covariantly constant (with respect to  $CP_2$  coordinates) right-handed neutrino spinor of  $M^4 \times CP_2$  since the Dirac operators of  $M^8$ ,  $H$ , and  $X^4$  reduce to free Dirac operator when acting on it in both  $M^8$  and  $H$  and giving also rise to super-conformal symmetry. The choice is unique apart from  $SO(3)$  rotation but the condition that spin eigen state is in question for the choice of quantization axis fixed by the choice of hyper-octonion units and also by the definition of the hierarchy of Planck constants fixes  $\Psi_0$  apart from the sign of the spin if reality is assumed. When  $p^k \gamma_k \Psi_0 = 0$  holds true for fixed  $\Psi_0$ , the ansatz fails so that the gauge choice is not global. There are two gauge patches corresponding to the two signs of the spin of  $\Psi_0$ . Right handed neutrino spinor reflects directly the homological magnetic monopole character of the Kähler form of  $CP_2$  so that the monopole property is in well defined sense transferred from  $CP_2$  to  $M^4$ . Note that this argument fails for quark spinors which do not allow any covariantly constant spinor.
4. For ordinary twistors the existence of the antisymmetric tensor  $\epsilon$  acting as Kähler form in the space of spinors is what allows to define second spinor and these spinors together form twistor. Ordinary twistors are pairs of spinors and also in the recent case one would have pairs of octo-spinors. The geometric interpretation would be as a light-like geodesic of  $M^8$  or tangent vector of light-like geodesic of  $M^4 \times CP_2$  and the two spinors would code for the momentum associated with the ray and the transverse position of the ray expressible in terms of a light-like vector. This would double the dimension to  $D=16$  which happens to be the dimension of complexified octonions. The standard definition of twistors would suggest that one has 2 triplets of this kind so that Dirac equation and above argument would reduce the situation to 16-dimensional one. Twistors space would be  $C^8$  and 14-D projective twistor space would correspond to  $CP_7$ .
5. 2-D spinor and its conjugate as independent representations of Lorentz group define twistor. In an analogous manner  $M^8$  vector,  $M^8$ -spinor, and its conjugate define a triplet as independent representations. One can therefore ask whether a triplet of these independent representations could define octo-twistor so that two triplets would not be needed. Together they would form an entity with 24 components when the overall complex phase is eliminated and if no gauge choice fixing  $\Psi_0$  is made apart from the assumption  $\Psi_0$  has real components. If the overall

phase is allowed, the number of components is 26 (the momentum constraint of course reduces the number of degrees of freedom to 8). It seems that the magic dimensions of string models are unavoidable! Perhaps it might be possible to reduce 26-D string theory to 8-D theory by posing triality symmetry and additional gauge symmetry. The problem of this identification is that one does not have a geometric interpretation as a lifting of the space of light-like geodesics. One could of course define octo-twistors as a pair of triplets with the members of triplet obtained from each other via triality symmetry.

### 8.5.2 Could right handed neutrino spinor modes define octo-twistors?

There is no absolute need to interpret induced spinor fields as parts of octo-twistors. One can however ask whether this might make sense for the solutions of the modified Dirac equation  $D\Psi = 0$  representing right-handed neutrino and expressible as  $\Psi = D\Psi_0$ .

1. In the modified Dirac equation gamma matrices are replaced by the modified gamma matrices defined by the variation of Kähler action and the massless momentum  $p^k\sigma_k$  is replaced with the modified Dirac operator  $D$ . In plane wave basis the derivatives in  $D$  reduce to algebraic multiplication operators in the case of right handed neutrino since right-handed neutrino has no gauge couplings.
2. A non-trivial consistency condition comes from the condition  $D^2\Psi_0 = 0$  giving sum of two terms.
  - (a) The first term is the analog of scalar d'Alembertian and given by

$$G^{\mu\nu} D_\mu D_\nu \Psi_0, \quad G^{\mu\nu} = h_{kl} T^{\mu k} T^{\nu l}, \quad T^{\mu k} = \frac{\partial L_K}{\partial h_\alpha^k},$$

and has quantum numbers of right handed neutrino as it should.

- (b) Second term is given by

$$T^{\mu k} D_\mu T^{\nu l} \Sigma_{kl} D_\nu \Psi_0,$$

and in the general case contains charged components. Only electromagnetically neutral  $CP_2$  sigma matrices having right handed neutrino as eigen state are allowed if one wants twistor interpretation. This is not true in the general case but might be implied by the preferred extremal property.

- (c) This property would allow to choose the induced spinor fields to be eigenstates of electromagnetic charge globally and would be therefore physically very attractive. After all, one of the basic interpretational problems has been the fact that classical  $W$  fields seem to induce mixing of quarks and leptons with different electro-magnetic charges. If this is the case one could assign to each point of the space-time surface octo-twistor like abstract entity as the triplet  $(\bar{\Psi}_0 D, D, D\Psi_0)$ . This would map space-time sheet to a 4-D surface (in real sense) in the space of 8-D (in complex sense) leptonic spinors.

### 8.5.3 Octo-twistors and modified Dirac equation

Classical number fields define one vision about quantum TGD. This vision about quantum TGD has evolved gradually and involves several speculative ideas.

1. The hard core of the vision is that space-time surfaces as preferred extremals of Kähler action can be identified as what I have called hyper-quaternionic surfaces of  $M^8$  or  $M^4 \times CP_2$ . This requires only the mapping of the modified gamma matrices to octonions or to a basis of subspace of complexified octonions. This means also the mapping of spinors to octonionic spinors. There is no need to assume that imbedding space-coordinates are octonionic.
2. I have considered also the idea that quantum TGD might emerge from the mere associativity.

- (a) Consider Clifford algebra of WCW. Treat "vibrational" degrees of freedom in terms second quantized spinor fields and add center of mass degrees of freedom by replacing 8-D gamma matrices with their octonionic counterparts - which can be constructed as tensor products of octonions providing alternative representation for the basis of 7-D Euclidian gamma matrix algebra - and of 2-D sigma matrices. Spinor components correspond to tensor products of octonions with 2-spinors: different spin states for these spinors correspond to leptons and baryons.
- (b) Construct a local Clifford algebra by considering Clifford algebra elements depending on point of  $M^8$  or  $H$ . The octonionic 8-D Clifford algebra and its local variant are non-associative. Associative sub-algebra of 8-D Clifford algebra is obtained by restricting the elements so any quaternionic 4-plane. Doing the same for the local algebra means restriction of the Clifford algebra valued functions to any 4-D hyper-quaternionic sub-manifold of  $M^8$  or  $H$  which means that the gamma matrices span complexified quaternionic algebra at each point of space-time surface. Also spinors must be quaternionic.
- (c) The assignment of the 4-D gamma matrix sub-algebra at each point of space-time surface can be done in many manners. If the gamma matrices correspond to the tangent space of space-time surface, one obtains just induced gamma matrices and the standard definition of quaternionic sub-manifold. In this case induced 4-volume is taken as the action principle. If Kähler action defines the space-time dynamics, the modified gamma matrices do not span the tangent space in general.
- (d) An important additional element is involved. If the  $M^4$  projection of the space-time surface contains a preferred subspace  $M^2$  at each point, the quaternionic planes are labeled by points of  $CP_2$  and one can equivalently regard the surfaces of  $M^8$  as surfaces of  $M^4 \times CP_2$  (number-theoretical "compactification"). This generalizes:  $M^2$  can be replaced with a distribution of planes of  $M^4$  which integrates to a 2-D surface of  $M^4$  (for instance, for string like objects this is necessarily true). The presence of the preferred local plane  $M^2$  corresponds to the fact that octonionic spin matrices  $\Sigma_{AB}$  span 14-D Lie-algebra of  $G_2 \subset SO(7)$  rather than that 28-D Lie-algebra of  $SO(7,1)$  whereas octonionic imaginary units provide 7-D fundamental representation of  $G_2$ . Also spinors must be quaternionic and this is achieved if they are created by the Clifford algebra defined by induced gamma matrices from two preferred spinors defined by real and preferred imaginary octonionic unit. Therefore the preferred plane  $M^3 \subset M^4$  and its local variant has direct counterpart at the level of induced gamma matrices and spinors.
- (e) This framework implies the basic structures of TGD and therefore leads to the notion of world of classical worlds (WCW) and from this one ends up with the notion WCW spinor field and WCW Clifford algebra and also hyper-finite factors of type  $II_1$  and  $III_1$ . Note that  $M^8$  is exceptional: in other dimensions there is no reason for the restriction of the local Clifford algebra to lower-dimensional sub-manifold to obtain associative algebra.

The above line of ideas leads naturally to (hyper-)quaternionic sub-manifolds and to basic quantum TGD (note that the "hyper" is un-necessary if one accepts just the notion of quaternionic sub-manifold formulated in terms of modified gamma matrices). One can pose some further questions.

1. Quantum TGD reduces basically to the second quantization of the induced spinor fields. Could it be that the theory is integrable only for 4-D hyper-quaternionic space-time surfaces in  $M^8$  (equivalently in  $M^4 \times CP_2$ ) in the sense than one can solve the modified Dirac equation exactly only in these cases?
2. The construction of quantum TGD -including the construction of vacuum functional as exponent of Kähler function reducing to Kähler action for a preferred extremal - should reduce to the modified Dirac equation defined by Kähler action. Could it be that the modified Dirac equation can be solved exactly only for Kähler action.
3. Is it possible to solve the modified Dirac equation for the octonionic gamma matrices and octonionic spinors and map the solution as such to the real context by replacing gamma matrices and sigma matrices with their standard counterparts? Could the associativity conditions for octospinors and modified Dirac equation allow to pin down the form of solutions to such a high degree that the solution can be constructed explicitly?



4. Octonionic gamma matrices provide also a non-associative representation for 8-D version of Pauli sigma matrices and encourage the identification of 8-D twistors as pairs of octonionic spinors conjectured to be highly relevant also for quantum TGD. Does the quaternionicity condition imply that octo-twistors reduce to something closely related to ordinary twistors as the fact that 2-D sigma matrices provide a matrix representation of quaternions suggests?

In the following I will try to answer these questions by developing a detailed view about the octonionic counterpart of the modified Dirac equation and proposing explicit solution ansätze for the modes of the modified Dirac equation.

### The replacement of $SO(7, 1)$ with $G_2$

The basic implication of octonionization is the replacement of  $SO(7, 1)$  as the structure group of spinor connection with  $G_2$ . This has some rather unexpected consequences.

#### 1. Octonionic representation of 8-D gamma matrices

Consider first the representation of 8-D gamma matrices in terms of tensor products of 7-D gamma matrices and 2-D Pauli sigma matrices.

1. The gamma matrices are given by

$$\gamma^0 = 1 \times \sigma_1 \quad , \quad \gamma^i = \gamma^i \otimes \sigma_2 \quad , \quad i = 1, \dots, 7 \quad . \quad (8.5.1)$$

7-D gamma matrices in turn can be expressed in terms of 6-D gamma matrices by expressing  $\gamma^7$  as

$$\gamma_{i+1}^{(7)} = \gamma_i^{(6)} \quad , \quad i = 1, \dots, 6 \quad , \quad \gamma_1^{(7)} = \gamma_7^{(6)} = \prod_{i=1}^6 \gamma_i^{(6)} \quad . \quad (8.5.2)$$

2. The octonionic representation is obtained as

$$\gamma_0 = 1 \times \sigma_1 \quad , \quad \gamma_i = e_i \otimes \sigma_2 \quad . \quad (8.5.3)$$

where  $e_i$  are the octonionic units.  $e_i^2 = -1$  guarantees that the  $M^4$  signature of the metric comes out correctly. Note that  $\gamma_7 = \prod \gamma_i$  is the counterpart for choosing the preferred octonionic unit and plane  $M^2$ .

3. The octonionic sigma matrices are obtained as commutators of gamma matrices:

$$\Sigma_{0i} = e_i \times \sigma_3 \quad , \quad \Sigma_{ij} = f_{ij}^k e_k \otimes 1 \quad . \quad (8.5.4)$$

These matrices span  $G_2$  algebra having dimension 14 and rank 2 and having imaginary octonion units and their conjugates as the fundamental representation and its conjugate. The Cartan algebra for the sigma matrices can be chosen to be  $\Sigma_{01}$  and  $\Sigma_{23}$  and belong to a quaternionic sub-algebra.

4. The lower dimension of the  $G_2$  algebra means that some combinations of sigma matrices vanish. All left or right handed generators of the algebra are mapped to zero: this explains why the dimension is halved from 28 to 14. From the octonionic triangle expressing the multiplication rules for octonion units [?] one finds  $e_4e_5 = e_1$  and  $e_6e_7 = -e_1$  and analogous expressions for the cyclic permutations of  $e_4, e_5, e_6, e_7$ . From the expression of the left handed sigma matrix  $I_L^3 = \sigma_{23} + \sigma^{30}$  representing left handed weak isospin (see the Appendix about the geometry of  $CP_2$  [?], [?]) one can conclude that this particular sigma matrix and left handed sigma matrices in general are mapped to zero. The quaternionic sub-algebra  $SU(2)_L \times SU(2)_R$  is mapped to that for the rotation group  $SO(3)$  since in the case of Lorentz group one cannot speak of a decomposition to left and right handed subgroups. The elements of the complement of the quaternionic sub-algebra are expressible in terms of  $\Sigma_{ij}$  in the quaternionic sub-algebra.

### 2. Some physical implications of $SO(7, 1) \rightarrow G_2$ reduction

This has interesting physical implications if one believes that the octonionic description is equivalent with the standard one.

1. If  $SU(2)_L$  is mapped to zero only the right-handed parts of electro-weak gauge field survive octonization. The right handed part is neutral containing only photon and  $Z^0$  so that the gauge field becomes Abelian.  $Z^0$  and photon fields become proportional to each other ( $Z^0 \rightarrow \sin^2(\theta_W)\gamma$ ) so that classical  $Z^0$  field disappears from the dynamics, and one would obtain just electrodynamics. This might provide a deeper reason for why electrodynamics is an excellent description of low energy physics and of classical physics. This is consistent with the fact that  $CP_2$  coordinates define 4 field degrees of freedom so that single Abelian gauge field should be enough to describe classical physics. This would remove also the interpretational problems caused by the transitions changing the charge state of fermion induced by the classical  $W$  boson fields.

Also the realization of  $M^8 - H$  duality led to the conclusion  $M^8$  spinor connection should have only neutral components. The isospin matrix associated with the electromagnetic charge is  $e_1 \times 1$  and represents the preferred imaginary octonionic unit so that that the image of the electro-weak gauge algebra respects associativity condition. An open question is whether octonization is part of  $M^8$ -H duality or defines a completely independent duality. The objection is that information is lost in the mapping so that it becomes questionable whether the same solutions to the modified Dirac equation can work as a solution for ordinary Clifford algebra.

2. If  $SU(2)_R$  were mapped to zero only left handed parts of the gauge fields would remain. All classical gauge fields would remain in the spectrum so that information would not be lost. The identification of the electro-weak gauge fields as three covariantly constant quaternionic units would be possible in the case of  $M^8$  allowing Hyper-Kähler structure [?], which has been speculated to be a hidden symmetry of quantum TGD at the level of WCW. This option would lead to difficulties with associativity since the action of the charged gauge potentials would lead out from the local quaternionic subspace defined by the octonionic spinor.
3. The gauge potentials and gauge fields defined by  $CP_2$  spinor connection are mapped to fields in  $SO(2) \subset SU(2) \times U(1)$  in quaternionic sub-algebra which in a well-defined sense corresponds to  $M^4$  degrees of freedom! Since the resulting interactions are of gravitational character, one might say that electro-weak interactions are mapped to manifestly gravitational interactions. Since  $SU(2)$  corresponds to rotational group one cannot say that spinor connection would give rise only to left or right handed couplings, which would be obviously a disaster.

### 3. Octo-spinors and their relation to ordinary imbedding space spinors

Octo-spinors are identified as octonion valued 2-spinors with basis

$$\begin{aligned} \Psi_{L,i} &= e_i \begin{pmatrix} 1 \\ 0 \end{pmatrix}, \\ \Psi_{q,i} &= e_i \begin{pmatrix} 0 \\ 1 \end{pmatrix}. \end{aligned} \tag{8.5.5}$$

One obtains quark and lepton spinors and conjugation for the spinors transforms quarks to leptons. Note that octospinors can be seen as 2-dimensional spinors with components which have values in the space of complexified octonions.

The leptonic spinor corresponding to real unit and preferred imaginary unit  $e_1$  corresponds naturally to the two spin states of the right handed neutrino. In quark sector this would mean that right handed U quark corresponds to the real unit. The octonions decompose as  $1 + 1 + 3 + \bar{3}$  as representations of  $SU(3) \subset G_2$ . The concrete representations are given by

$$\begin{aligned} \{1 \pm ie_1\} &, & e_R \text{ and } \nu_R \text{ with spin } 1/2 &, \\ \{e_2 \pm ie_3\} &, & e_R \text{ and } \nu_L \text{ with spin } -1/2 &, \\ \{e_4 \pm ie_5\} &, & e_L \text{ and } \nu_L \text{ with spin } 1/2 &, \\ \{e_6 \pm ie_7\} &, & e_L \text{ and } \nu_L \text{ with spin } 1/2 &. \end{aligned} \tag{8.5.6}$$

Instead of spin one could consider helicity. All these spinors are eigenstates of  $e_1$  (and thus of the corresponding sigma matrix) with opposite values for the sign factor  $\epsilon = \pm$ . The interpretation is in terms of vectorial isospin. States with  $\epsilon = 1$  can be interpreted as charged leptons and D type quarks and those with  $\epsilon = -1$  as neutrinos and U type quarks. The interpretation would be that the states with vanishing color isospin correspond to right handed fermions and the states with non-vanishing SU(3) isospin (to be not confused with QCD color isospin) and those with non-vanishing SU(3) isospin to left handed fermions. The only difference between quarks and leptons is that the induced Kähler gauge potentials couple to them differently.

The importance of this identification is that it allows a unique map of the candidates for the solutions of the octonionic modified Dirac equation to those of ordinary one. There are some delicacies involved due to the possibility to chose the preferred unit  $e_1$  so that the preferred subspace  $M^2$  can corresponds to a sub-manifold  $M^2 \subset M^4$ .

### Octonionic counterpart of the modified Dirac equation

The solution ansatz for the octonionic counterpart of the modified Dirac equation discussed below makes sense also for ordinary modified Dirac equation which raises the hope that the same ansatz, and even same solution could provide a solution in both cases.

#### 1. The general structure of the modified Dirac equation

In accordance with quantum holography and the notion of generalized Feynman diagram, the modified Dirac equation involves two equations which must be consistent with each other.

1. There is 3-dimensional generalized eigenvalue equation for which the modified gamma matrices are defined by Chern-Simons action defined by the sum  $J_{tot} = J + J_1$  of Kähler forms of  $S^2$  and  $CP_2$  [K15, ?].

$$\begin{aligned} D_3 \Psi &= [D_{C-S} + Q_{C-S}] \Psi = \lambda^k \gamma_k \Psi , \\ Q_{C-S} &= Q_\alpha \hat{\Gamma}_{C-S}^\alpha , \quad Q_\alpha = Q_A g^{AB} j_{B\alpha} . \end{aligned} \tag{8.5.7}$$

The gamma matrices  $\gamma_k$  are  $M^4$  gamma matrices in standard Minkowski coordinates and thus constant. Given eigenvalue  $\lambda_k$  defines pseudo momentum which is some function of the genuine momenta  $p_k$  and other quantum numbers via the boundary conditions associated with the generalized eigenvalue equation.

The charges  $Q_A$  correspond to real four-momentum and charges in color Cartan algebra. The term  $Q$  can be rather general since it provides a representation for the measurement interaction by mapping observables to Cartan algebra of isometry group and to the infinite hierarchy of conserved currents implied by quantum criticality. The operator  $O$  characterizes the quantum critical conserved current. The surface  $Y_l^3$  can be chosen to be any light-like 3-surface "parallel" to the wormhole throat in the slicing of  $X^4$ : this means an additional symmetry. Formally the

measurement interaction term can be regarded as an addition of a gauge term to the Kähler gauge potential associated with the Kähler form  $J_{tot}$  of  $S^2 \times CP_2$ .

The square of the equation gives the spinor analog of d'Alembert equation and generalized eigenvalue as the analog of mass squared. The propagator associated with the wormhole throats is formally massless Dirac propagator so that standard twistor formalism applies also without the octonionic representation of the gamma matrices although the physical particles propagating along the opposite wormhole throats are massive on mass shell particles with both signs of energy [?] .

2. Second equation is the 4-D modified Dirac equation defined by Kähler action.

$$D_K \Psi = 0 . \quad (8.5.8)$$

The dimensional reduction of this operator to a sum corresponding to  $D_{K,3}$  acting on light-like 3-surfaces and 1-D operator  $D_{K,1}$  acting on the coordinate labeling the 3-D light-like 3-surfaces in the slicing would allow to assign eigenvalues to  $D_{K,3}$  as analogs of energy eigenvalues for ordinary Schrödinger equation. One proposal has been that Dirac determinant could be identified as the product of these eigen values. Another and more plausible identification is as the product of pseudo masses assignable to  $D_3$  defined by Chern-Simons action [?] . It must be however made clear that the identification of the exponent of the Kähler function to Chern-Simons term makes the identification as Dirac determinant un-necessary.

3. There are two options depending on whether one requires that the eigenvalue equation applies only on the wormhole throats and at the ends of the space-time surface or for all 3-surfaces in the slicing of the space-time surface by light-like 3-surfaces. In the latter case the condition that the pseudo four-momentum is same for all the light-like 3-surfaces in the slicing gives a consistency condition stating that the commutator of the two Dirac operators vanishes for the solutions in the case of preferred extremals, which depend on the momentum and color quantum numbers also:

$$[D_K, D_3] \Psi = 0 . \quad (8.5.9)$$

This condition is quite strong and there is no deep reason for it since  $\lambda_k$  does not correspond to the physical conserved momentum so that its spectrum could depend on the light-like 3-surface in the slicing. On the other hand, if the eigenvalues of  $D_3$  belong to the preferred hyper-complex plane  $M^2$ ,  $D_3$  effectively reduces to a 2-dimensional algebraic Dirac operator  $\lambda^k \gamma_k$  commuting with  $D_K$ : the values of  $\lambda^k$  cannot depend on slice since this would mean that  $D_K$  does not commute with  $D_3$ .

### 2. About the hyper-octonionic variant of the modified Dirac equation

What gives excellent hopes that the octonionic variant of modified Dirac equation could lead to a provide precise information about the solution spectrum of modified Dirac equation is the condition that everything in the equation should be associative. Hence the terms which are by there nature non-associative should vanish automatically.

1. The first implication is that the besides octonionic gamma matrices also octonionic spinors should belong to the local quaternionic plane at each point of the space-time surface. Spinors are also generated by quaternionic Clifford algebra from two preferred spinors defining a preferred plane in the space of spinors. Hence spinorial dynamics seems to mimic very closely the space-time dynamics and one might even hope that the solutions of the modified Dirac action could be seen as maps of the space-time surface to surfaces of the spinor space. The reduction to quaternionic sub-algebra suggest that some variant of ordinary twistors emerges in this manner in matrix representation.

2. The octonionic sigma matrices span  $G_2$  where as ordinary sigma matrices define  $SO(7, 1)$ . On the other hand, the holonomies are identical in the two cases if right-handed charge matrices are mapped to zero so that there are indeed hopes that the solutions of the octonionic Dirac equation cannot be mapped to those of ordinary Dirac equation. If left-handed charge matrices are mapped to zero, the resulting theory is essentially the analog of electrodynamics coupled to gravitation at classical level but it is not clear whether this physically acceptable. It is not clear whether associativity condition leaves only this option under consideration.
3. The solution ansatz to the modified Dirac equation is expected to be of the form  $\Psi = D_K(\Psi_0 u_0 + \Psi_1 u_1)$ , where  $u_0$  and  $u_1$  are constant spinors representing real unit and the preferred unit  $e_1$ . Hence constant spinors associated with right handed electron and neutrino and right-handed  $d$  and  $u$  quark would appear in  $\Psi$  and  $\Psi_i$  could correspond to scalar coefficients of spinors with different charge. This ansatz would reduce the modified Dirac equation to  $D_K^2 \Psi_i = 0$  since there are no charged couplings present. The reduction of a d'Alembert type equation for single scalar function coupling to  $U(1)$  gauge potential and  $U(1)$  "gravitation" would obviously mean a dramatic simplification raising hopes about integrable theory.
4. The condition  $D_K^2 \Psi = 0$  involves products of three octonions and involves derivatives of the modified gamma matrices which might belong to the complement of the quaternionic sub-space. The restriction of  $\Psi$  to the preferred hyper-complex plane  $M^2$  simplifies the situation dramatically but  $(D_K^2)D_K \Psi = D_K(D_K^2)\Psi = 0$  could still fail. The problem is that the action of  $D_K$  is not algebraic so that one cannot treat reduce the associativity condition to  $(AA)A = A(AA)$ .

#### Could the notion of octo-twistor make sense?

Twistors have led to dramatic successes in the understanding of Feynman diagrammatics of gauge theories,  $N = 4$  SUSYs, and  $N = 8$  supergravity [?, ?, ?]. This motivated the question whether they might be applied in TGD framework too [?] - at least in the description of the QFT limit. The basic problem of the twistor program is how to overcome the difficulties caused by particle massivation and TGD framework suggests possible clues in this respect.

1. In TGD it is natural to regard particles as massless particles in 8-D sense and to introduce 8-D counterpart of twistors by relying on the geometric picture in which twistors correspond to a pair of spinors characterizing light-like momentum ray and a point of  $M^8$  through which the ray traverses. Twistors would consist of a pair of spinors and quark and lepton spinors define the natural candidate for the spinors in question. This approach would allow to handle massive on-mass-shell states but cannot cope with virtual momenta massive in 8-D sense.
2. The emergence of pseudo momentum  $\lambda_k$  from the generalized eigenvalue equation for  $D_{C-S}$  suggest a dramatically simpler solution to the problem. Since propagators are effectively massless propagators for pseudo momenta, which are functions of physical on shell momenta (with both signs of energy in zero energy ontology) and of other quantum numbers, twistor formalism can be applied in its standard form. An attractive assumption is that also  $\lambda^k$  are conserved in the vertices but a good argument justifying this is lacking. One can ask whether also  $N = 4$  SUSY,  $N = 8$  super-gravity, and even QCD could have similar interpretation.

This picture should apply also in the case of octotwistors with minor modifications and one might hope that octotwistors could provide new insights about what happens in the real case.

1. In the case of ordinary Clifford algebra unit matrix and six-dimensional gamma matrices  $\gamma_i$ ,  $i = 1, \dots, 6$  and  $\gamma_7 = \prod_i \gamma_i$  would define the variant of Pauli sigma matrices as  $\sigma_0 = 1$ ,  $\sigma_k = \gamma_k$ ,  $k = 1, \dots, 7$ . The problem is that masslessness condition does not correspond to the vanishing of the determinant for the matrix  $p_k \sigma^k$ .
2. In the case of octo-twistors Pauli sigma matrices  $\sigma^k$  would correspond to hyper-octonion units  $\{\sigma_0, \sigma_k\} = \{1, ie^k\}$  and one could assign to  $p_k \sigma^k$  a matrix by the linear map defined by the multiplication with  $P = p_k \sigma^k$ . The matrix is of form  $P_{mn} = p^k f_{kmn}$ , where  $f_{kmn}$  are the structure constants characterizing multiplication by hyper-octonion. The norm squared for octonion is the fourth root for the determinant of this matrix. Since  $p_k \sigma^k$  maps its octonionic

conjugate to zero so that the determinant must vanish (as is easy to see directly by reducing the situation to that for hyper-complex numbers by considering the hyper-complex plane defined by  $P$ ).

3. Associativity condition for the octotwistors requires that the gamma matrix basis appearing in the generalized eigenvalue equation for Chern-Simons Dirac operator must differ by a local  $G_2$  rotation from the standard hyper-quaternionic gamma matrix for  $M^4$  so that it is always in the local hyper-quaternionic plane. This suggests that octo-twistor can be mapped to an ordinary twistor by mapping the basis of hyper-quaternions to Pauli sigma matrices. A stronger condition guaranteeing the commutativity of  $D_3$  with  $\lambda^k \gamma_k$  is that  $\lambda_k$  belongs to a preferred hyper-complex plane  $M^2$  assignable to a given  $CD$ . Also the two spinors should belong to this plane for the proposed solution ansatz for the modified Dirac equation. Quaternionization would also allow to assign momentum to the spinors in standard manner.

The spectrum of pseudo-momenta would be 2-dimensional (continuum at worst) and this should certainly improve dramatically the convergence properties for the sum over the non-conserved pseudo-momenta in propagators which in the worst possible of worlds might destroy the manifest finiteness of the theory based on the generalized Feynman diagrams with the throats of wormholes carrying always on mass shell momenta. This effective 2-dimensionality should apply also in the real case and would have no catastrophic consequences since pseudo momenta are in question.

As a matter fact, the assumption the decomposition of quark momenta to longitudinal and transversal parts in perturbative QCD might have interpretation in terms of pseudo-momenta if they are conserved.

4.  $M^8 - H$  duality suggests a possible interpretation of the pseudo-momenta as  $M^8$  momenta which by purely number theoretical reasons must be commutative and thus belong to  $M^2$  hyper-complex plane. One ends up with the similar outcome as one constructs a representation for the quantum states defined by WCW spinor fields as superpositions of real units constructed as ratios of infinite hyper-octonionic integers with precisely defined number theoretic anatomy and transformation properties under standard model symmetries having number theoretic interpretation [?] .

### 8.5.4 What one really means with a virtual particle?

Massive particles are the basic problem of the twistor program. The twistorialization of massive particles does not seem to be a problem in TGD framework thanks to the possibility to interpret them as massless particles in 8-D sense but the situation is unsatisfactory for virtual particles.

The ideas possibly allowing to circumvent this problem emerged from a totally unexpected direction. The inspiration came from the finding of Martin Grusenick [?] who discovered that a Mickelson-Morley interferometer rotating in plane gives rise a non-trivial interference pattern when the plane is orthogonal to the Earth's surface but no effect when parallel to the Earth's surface. The effect could be due to a contraction of the system in the vertical direction caused by the own weight of the system and would thus involve no new physics. If not, then one must try to find General Relativistic explanation for it. Schwarzschild metric predicts this kind of effect but it is by a factor  $10^{-4}$  too small.

In TGD framework one can however consider an explanation of the effect [K77] .

1. By relaxing the empty space assumption to the assumption that only the energy density (that is  $G^{tt}$ ) vanishes but the other diagonal components of Einstein tensor in Schwarzschild coordinates can be non-vanishing allows to explain the effect in terms of the deviation of the radial component  $g_{rr}$  of the metric from Schwarzschild metric. The predicted deviation decreases as  $1/r$  and does not affect planetary orbits appreciably even if present for all astrophysical objects. The value of  $G$  determined from radial acceleration at the surface of Earth is predicted to deviate from the actual value as a consequence. The deviation of the metric from empty space metric could also explain the known surprisingly large variation in the measured values of  $G$  since nearby gravitational fields are involved.
2. The Einstein tensor in regions with vanishing energy density would obviously correspond to a tachyonic matter. This led to a series of ideas allowing to sharpen the physical meaning of

Einstein's equations in TGD framework. The basic result would be the extension of quantum classical correspondence. The Einstein tensor in matter free regions would describe the presence of virtual particles and would fail to satisfy causality constraint since it corresponds to the space-like momentum exchange of the system with the external world (space-likeness follows if the scattering is elastic).

3. It is difficult to understand how the energy momentum tensor of matter could behave like  $G^{\alpha\beta}$  does if the latter describes tachyons. The resolution of the problem could be very simple in zero energy ontology. In zero energy ontology bosons (and their super counterparts) correspond to wormhole contacts carrying fermion and antifermion numbers at the light-like wormhole throats and having opposite signs of energy. This allows the possibility that the fermions at the throats are on mass shell and the sum of their momenta gives rise to off mass shell momentum which can be also space-like. In zero energy ontology  $G^{\alpha\beta}$  would naturally correspond to the sum of on mass shell energy energy momentum tensors  $T_{\pm}^{\alpha\beta}$  associated with positive and negative energy fermions and their super-counterparts. Note that for the energy momentum tensor  $T^{\alpha\beta} = (\rho + p)u^{\alpha}u^{\beta} - pg^{\alpha\beta}$  of fluid with  $u^{\alpha}u_{\alpha} = 1$  constraint stating on mass shell condition the allowance of virtual particles would mean giving up the condition  $u^{\alpha}u_{\alpha} = 1$  for the velocity field.

### Could virtual particles be regarded as pairs of on mass shell particles with opposite energies?

This identification suggests a concrete identification of virtual particle as pairs of positive and negative energy on mass shell particles allowing an elegant formulation of the twistor program in the case of virtual particles [?, ?].

1. The basic idea is that massive on mass shell states can be regarded as massless states in 8-dimensional sense so that twistor program generalizes to the case of massive on mass shell states associated with the representations of super-conformal algebras. One has however allow now also off mass shell states, in particular those with space-like momenta, and the question is how to describe them in terms of generalized twistors. In the case of wormhole contacts the answer looks obvious. Bosons and their super partners could correspond to pairs of positive and negative energy on mass shell states and could be described using a pair of twistors associated with composite momenta massless in 8-D sense.
2. It took some time to realize that the most elegant identification of the on mass shall bosons would be as wormhole contacts for which both throats have either positive or negative energy. This would imply automatically on-mass shell property. The basic objection against this has been that one cannot construct massless spin 1 states in this manner. Dirac equation in  $M^4$  implies that the momenta are parallel and for fermion and antifermion the helicities are therefore opposite and only longitudinal polarization representing pure gauge degree of freedom is possible. It is amazing how long time it required to realize that I had swallowed this objection completely uncritically. After all, the first thing that I learned from the Dirac equation for massless induced spinors is that it mixes unavoidably  $M^4$  chiralities except for very special vacuum extremals like canonically imbedded  $M^4$ . Same applies to the modified Dirac equation. Therefore there is no problem! Of course, also the p-adic mass calculations involve imbedding spaced spinors for which  $M^4$  helicities are mixed strongly since only covariantly constant right handed neutrino is massless and possesses a well defined  $M^4$  helicity. At space-time level a pair of massless extremals (topological light rays) with same (opposite) energies and connected by wormhole contacts could serve as a space-time correlate for on (off) mass shell boson.
3. How can one then identify virtual fermions and their super-counterparts? These particles have been assumed to consist of single wormhole throat associated with a deformation of  $CP_2$  vacuum extremal so that the proposed definition would allow only on mass shell states. A possible resolution of the problem is the identification of also virtual fermions and their super-counterparts as wormhole contacts in the sense that the second wormhole throats is fermionic Fock vacuum carrying purely bosonic quantum numbers and corresponds to a state generated by purely bosonic generators of the super-symplectic algebra whose elements are in 1-1 correspondence

with Hamiltonians of  $\delta M_{\pm}^4 \times CP_2$ . Thus the distinction between on mass shell and off mass shell states would be purely topological for fermions and their super partners.

4. The concrete physical interpretation would be that particle scattering event involves at least two parallel space-time sheets. Incoming (outgoing) fermion is topologically condensed at positive energy (negative energy) sheet and corresponds to single throat. In the interaction region fermionic space-time sheet touches with a high probably the large space-time sheet since the distance between sheets is about  $10^4$  Planck lengths. The touching (topological sum) generates a second wormhole throat with a spherical topology and carrying no fermion number but having on mass shell momentum. Virtual fermions would be interacting fermions. Since only topological sum contacts are formed, also virtual fermions are labeled by the genus  $g$  of the 2-D wormhole throat whereas bosons are labeled by the pair  $(g_1, g_2)$  of the genera of two wormhole throats. This classification is consistent with the mechanism giving rise to virtual bosons.

The proposed identification of virtual and on mass shell particles is beautiful but it is of course far from obvious whether it really make sense. Bosonic emergence means that the fundamental loop integrals are for fermionic loops. One could in principle get rid of bosonic loop integrals by using generalized Cutkosky rules [?, ?] but it would be highly satisfying to have a concrete physical interpretation for the loops. It interesting to see whether the proposed picture works in practice. Bosonic emergence means that one path integrates first over fermions to get bosonic action as radiative corrections. Only 3-vertices (or rather, 3 momenta are associated with the vertex [?]) are involved at the fermion level whereas at the bosonic level arbitrary high vertices appear.

### How to treat the new degrees of freedom?

The identification of off mass shell states as on mass shell states of positive and negative energy throats brings in new degrees of freedom. Let us first look what happens if the momenta of the two throats of wormhole contact are completely uncorrelated apart from the condition  $p_1 - p_2 = p$  coming from the energy conservation in the 3-vertex. Here  $p_1$  ( $-p_2$ ) is the momentum of on mass shell positive (negative) energy throat and  $p$  is the momentum of outgoing (incoming) wormhole contact. On mass shell conditions eliminate two degrees of freedom so that in absence of correlations the 4-D integral over loop momenta should be extended to a 6-D integral. For a given time-like virtual momentum  $p$  these degrees of freedom corresponds to 2-dimensional sphere as one finds by looking the situation in the rest system of  $p$  (the direction of  $\bar{p}_1 = -\bar{p}_2$  is arbitrary) so that additional loop integration is finite. For light-like  $p$  the additional degrees of freedom correspond to 2-D light-cone boundary  $\delta M_+^3$  defined by the condition  $t^2 - x^2 - y^2 = 0$ :  $\delta M_+^3$   $SO(1, 2)$  invariant 2-volume does not exist. This is not a catastrophe since massless momenta define lower-dimensional sub-manifold of the momentum space. For space-like  $p$  one has hyperboloid  $t^2 - x^2 - y^2 = -1$  and the 2-D loop integral would be infinite in absence of additional constraints.

A 2-dimensional integral appears at each line of Feynman diagram and if the only constraint comes from  $p_1 - p_2 = p$  one obtains new divergences for space-like momenta  $p$ . One can imagine several approaches to the problem.

1. The most conservative approach assumes that the freedom to select the decomposition  $p = p_1 + p_2$  is completely analogous to a gauge symmetry. This is the case if the propagators are just the usual ones. Although this decomposition would take place it would not have any physical consequences since scattering amplitudes do not depend on the choices of these decompositions. For each line the integral over the decompositions normalized by the volume of  $S^2$  or hyperboloid would give the same result as an arbitrary gauge choice fixing the decompositions.
2. For the second option the new degrees of freedom would be present for each line of the generalized Feynman diagram in a non-trivial manner, and the dependence of the emission vertices on the decompositions should allow to avoid the infinities for space-like  $p$ . The vertices would depend on Lorentz invariant quantities such as  $k \cdot p_1$  and  $k \cdot p_2$ , where  $k$  denotes the momentum of any line coming to the vertex, and in an optimist mood one could ask whether this dependence could allow to smooth out also the standard loop divergences by bringing in the effective momentum cutoff through the new momentum degrees of freedom. In twistorial description this kind of dependence could allow especially elegant realization. Note that also a sum over mass shells is involved and can cause divergences.



3. For the third option the new degrees of freedom would be eliminated by some physical mechanism fixing the direction of the projection of  $p_1$  (and  $p_2$ ) in the hyperplane normal to  $p$ . The minimum option would eliminate the additional 2-dimensional integral but would not pose conditions on the loop momenta  $p_1$  and  $p_2$ . One should be able to fix the direction of the projection of  $p_1$  in the hyperplane  $P(p)$  whose normal is  $p$  by some rule having a physical justification. As a matter of fact, this option would be special case of the first one.

Bosonic sector (with super partners included) poses additional conditions. N-boson vertices are defined by fermionic loops and N-boson vertices with arbitrary large value of  $N$  are possible. Bosonic propagators emerge as inverses of 2-boson vertices defined by fermionic loops. Let  $p_B = p_1 + p_2$  denote the sought for decomposition to on mass shell momenta. For the first and second options there are no obvious problems in the bosonic sector. For the third option there is a serious difficulty involved the decompositions  $p_B = p_1 + p_2$  defined by the vertices at the opposite ends of the boson line are not in general consistent. This kind of conditions lead to a hopelessly clumsy formalism.

### Could additional degrees of freedom allow natural cutoff in loop integrals?

Second option involving two new degrees of freedom for each internal line deserves a more detailed discussion. The masses assignable to on mass shell throats define an inherent momentum cutoff allowing to get rid of infinities without giving up conformal invariance. Of course, mass squared cutoff comes also from the breakdown of the QFT limit at  $CP_2$  length scale but one might hope that this cutoff is not actually needed.

1. To see what is involved, consider a BFF vertex with the fermionic momenta  $p_1 = p_{11} + p_{12}$  and  $p_2 = p_{21} + p_{22}$ , and bosonic momentum  $p_3 = p_{31} + p_{32}$ . As a concrete example, one might consider the calculation of bosonic propagator as the inverse of the bosonic 2-vertex involving fermion loop for which a model was discussed in [?]. For definiteness restrict the consideration to the decomposition of the fermionic momentum  $p_1$ . The natural direction in the orthogonal complement  $P(p_1)$  of  $p_1$  is defined by  $p_2$  (equivalently by  $p_3$ ). The corresponding momentum projections

$$P_{i1} = p_i - \frac{p_i \cdot p_1 p_1}{p_1^2}, \quad i = 2, 3$$

are the same.  $P_{i1}$  in general diverges for  $p_1^2 = 0$ .

2. Conformal invariance allows only dimensionless Lorentz invariants constructed from the momenta. Strong form of the conformal invariance does not allow dependence on the masses of the throats. For time-like (space-like)  $p_1$  the dimensionless variable

$$c_{12} \equiv \frac{p_{11} \cdot P_{21}}{\sqrt{p_{11}^2} \sqrt{P_{21}^2}} = c_{13}$$

describes the cosine (hyperbolic cosine) of the angle (hyperbolic angle) between  $p_{11}$  and  $P_{21}$ . The corresponding sine (hyperbolic sine)  $s_{i,i+1}$  vanishes when  $p_{11}$  is parallel to the projection of  $p_2$  ( $p_3$ ) in  $P(p_1)$ . Similar variables can be assigned to  $p_2$  and  $p_3$ . Together with the three analogous variables

$$c_{i,i} = \frac{p_{i1} \cdot p_i}{\sqrt{p_{i1}^2} \sqrt{p_i^2}}$$

measuring the hyperbolic angle between between  $p_{i1}$  and  $p_i$ , one has 6 variables.  $p_{i1}^2$  and  $p_i^2$  can have both signs and also vanish and this might lead difficulties if one wants Gaussians and analyticity.

3. The on mass shell property for throats allows to consider a milder form of conformal invariance for which one has variables

$$C_{12} \equiv \frac{p_{11} \cdot P_{21}}{m_1 m_2} = C_{13} \quad ,$$

where  $m_i$ ,  $i = 1, 2$  denote that throat masses. This introduces a cutoff in  $P_{21}$  when  $p_1$  is space-like. These variables have infinite values for massless throats so that massless throats cannot appear as building bricks of the virtual particles. The assumption that on mass-shell bosons involve massless wormhole throat would distinguish them from virtual bosons in a unique manner.

4. One can also identify dimensionless quantities formed from the loop momenta. Strong form of conformal invariance allows only

$$d_{ij} = \frac{p_i \cdot p_j}{\sqrt{p_i^2} \sqrt{p_j^2}}$$

possible also for ordinary loops. These variables give hope about cutoff with respect to Lorentz boost for  $p_i$  in the rest system of  $p_j$  but again the signs are problematic. The weaker form of conformal invariance allows also the variables

$$D_{ij} = \frac{p_i \cdot p_j}{m_i m_j}$$

not plagued by the sign problems and giving hopes also about mass squared cutoff. Indeed, if on mass shell throats are present they should take a key role in the physics of the virtual particles.

The following two simple examples give an idea about what might be involved.

1. Consider first a vertex factor which is a Gaussian of form  $\exp(-\sum_{ij} S_{ij}^2) = \exp(-2\sum_i (S_{i,i+1})^2 - \sum_i S_{i,i}^2)$  suppressing the the momenta  $p_{i1}$  for which the projections in  $P(p_i)$  are not parallel to those of  $p_j$  and also large boosts of  $p_{i1}$  in the rest system of  $p_i$ . Massless throats would not appear at all in internal lines. The additional 2-D integrals together with the correlation between  $p_k$  and  $p_{i1}$  do not probably smooth out the standard loop divergences in momentum squared and hyperbolic angle. The replacement of  $S_{ij}$  with  $s_{ij}$  together with analyticity leads to difficulties since  $s_{ij}$  does not have a definite sign.
2. The exponential  $\exp(-\sum_{i \neq j} D_{ij}^2)$  forces the decoupling of massless throats from virtual states, is free of the sign difficulties, and allows a stronger hyperbolic cutoff as well as mass scale cutoff. The replacement of  $D_{ij}$  with  $d_{ij}$  leads to the same problems as encountered in the first example. The simple model for the hyperbolic cutoff discussed in [?] could allow a more refined formulation in this framework. It is however important to realize that this kind of cutoffs look rather adhoc for the generalization of supersymmetric action for fermions [?]. They might be present in the radiatively generated bosonic action.

### Could quantum classical correspondence fix the correct option?

Concerning the dynamics in the new degrees of freedom the above argument lead two options under consideration. The first option assumes  $M^2$  gauge invariance and can be criticized as being somewhat ad hoc unless one can find a convincing interpretation for the restriction of the momenta  $p_1$  and  $p_2$  to  $M^2 \cap P(p)$ , where  $M^2$  denotes a sub-space of  $M^4$  defining the space of non-physical polarizations and  $P(p)$  is the orthogonal complement of  $p = p_1 + p_2$ . For both options one can argue that the decomposition  $p = p_1 + p_2$  should have same space-time correlate.

1. Preferred extremals of Kähler action are characterized by a local choice of  $M^2(x) \subset M^4$  in such a manner that the subspaces  $M^2(x)$  integrate to a 2-D surface in  $M^4$ .  $M^2(x)$  has a physical interpretation as the sub-space of non-physical polarizations. Number theoretical interpretation is as a hyper-complex plane of complexified octonions. In the generalized Feynman diagrammatics only the choice of  $M^2(x)$  at the 2-D partonic 2-surfaces  $X^2$  identified as the ends the 3-D light-like wormhole throats  $X_l^3$  matters. For a given line one can also restrict the consideration

to single point  $x$  of  $X^2$  since fermion numbers is carried by a light-like curve along  $X_l^3$ : the is an integral over possible choices of course. The additional degrees of freedom would therefore have a concrete interpretation in terms of space-time surfaces. The effective two-dimensionality states that  $M$ -matrix depends only the partonic 2-surfaces and their 4-D tangent spaces containing  $M^2(x)$  at the ends of the lines of generalized Feynman diagrams.

2. The first option would mean a complete independence on  $M^2(x)$  at partonic 2-surface implied by the first option would mean actual 2-dimensionality instead of only effective one. This is not quite in spirit of quantum TGD although it might make sense at QFT limit.
3. For the second option preferred extremals would reflect in their properties the decomposition  $p = p_1 + p_2$  for the internal lines and the dependence of vertices on the decomposition could correspond to the value of the vacuum functional for a given distribution of the planes  $M^2(x)$ . The locality of the choice  $M^2(x)$  would mean that  $p_1$  and  $p_2$  are not separately conserved during the propagation along the internal line and physical picture suggests that the choice  $M^2(x)$  is constant for light-like 3-surfaces representing lines of the generalized Feynman diagrams.

### Could the formulation of SUSY limit of TGD allow the new view about off mass shell particles?

Could the proposed heuristic ideas about off mass shell particles and diagram-wise finiteness of the perturbation theory, the suggested manner to fix the direction of the projections of  $p_1$  and  $p_2$  in  $P(p)$  in terms of the preferred polarization plane  $M^2 \subset M^4$  characterizing a given line of Feynman diagram, and the formulation of super-symmetric QFT limit of TGD [?] be consistent with each other?

1. There are good arguments that the generalized SUSY based on bosonic emergence and the generalization of super field concept guarantees the cancelation of divergences associated with particles and their super-partners. The new view about off mass shell particles encourages a dream about the finiteness of the individual diagrams justifying the motivations for the primitive model of [?] .
2. The description of bosons and their superpartners as wormhole throats requires at the fundamental level the introduction of new degrees of freedom associated with  $p = p_1 - p_2$  decomposition. On mass shell property is possible and would realize twistorial dreams. If one keeps the original view about virtual fermions and their super-partners as single throated objects, there is no need to describe virtual fermions as wormhole contacts.
3. Quantum classical correspondence suggests that the projections of  $p_1$  and  $p_2$  into  $P(p)$  lie in the intersection  $M^2 \cap P(p)$ , where  $M^2$  characterizes the line of the generalized Feynman diagram. If so, then the new degrees of freedom mean integral over the planes  $M^2$  labeled by the points of  $s \in S^2$ . If also virtual fermions correspond to wormhole contacts, BFF-vertices would contain an amplitude  $f(\alpha, s_1, s_2, s_3)$  with  $s_i$  characterizing the lines. The parameters  $\alpha$  would code information about the momenta of virtual particles, about the masses of on mass shell particles comprising the virtual particles, and also about the dynamics of Kähler action involving exponent of Kähler function for the extremal in question. If virtual fermions are single throated, one has  $f(\alpha, s)$  with  $s$  characterizing the bosonic line. The generalization would require a characterization of the form factor  $f(\alpha, s_1, s_2, s_3)$  or  $f(\alpha, s)$  in principle predicted by TGD proper but probably only modelable at QFT limit. The view about preferred extremals allows the possibility that  $s_i$  is not conserved along line. If the values of  $s_i$  at the ends of the line are not correlated, the integral over  $s_i$  gives a form factor  $F(\alpha)$ .
4. The propagators for the generalized chiral super-field describing fermions would not be affected, and the effects of  $f$  would be only seen at the level of propagators and vertices for bosons and their super-partners.  $f$  could in principle guarantee the finiteness of individual contributions to both fermionic and bosonic loops without the need for Wick rotation.

### Trying to sum up

The proposed replacement of virtual particles as a convenient mathematical abstraction with something very real suggests that the black box of the loop integrals could be opened and one might even

construct concrete models for off mass shell particles using twistorial formulation. The conservative approach would interpret the non-uniqueness of the decomposition of the loop momenta to on mass shell momenta in terms of gauge invariance. A more radical approach would assign two additional degrees of freedom to each line of generalized Feynman diagram and allow vertices to depend on the decomposition. This would give even hopes about the smoothing out of the standard divergences. As a matter fact, this idea was followed already in the chapter about bosonic emergence [?], where it was proposed that natural physical cutoffs on mass squared and hyperbolic angle characterizing the energy of virtual particle could guarantee the finiteness of fermionic loops. The construction of the super-symmetric QFT limit of TGD [?] however suggests that the cancelation of infinities takes place by super-symmetry even without cutoffs. One interpretation is that this cancelation justifies the neglect of the physical cutoff as an excellent approximation. An interesting question is whether the loop integrals could make sense even without Wick rotation.

## 8.6 Does weak form of electric-magnetic duality lead to a twistorial description?

This section summarizes an further vision about how twistors might emerge from quantum TGD. It is only loosely related to the other visions and is certainly the simplest one and also very closely related to the recent picture about generalized Feynman diagrams. Of course, it is bound to be speculative just like all other considerations of this chapter and one cannot take the details of the proposal too seriously.

### 8.6.1 The simplest vision about how twistors might emerge from TGD

The vision involves the notions of bosonic emergence, the identification of virtual states as pairs of on mass shell states assignable to wormhole throats inspired by zero energy ontology and associated realization of Cutkosky rules in terms of manifestly finite Feynman diagrammatics, and as the latest piece the weak form of electric-magnetic duality and the notion of pseudo-momentum emerging from the generalized eigenstates of the Chern-Simons Dirac operator. There must be a correlation between pseudo-momenta and real momenta and the identification of the difference of pseudo-momenta of wormhole throats as the difference of corresponding on mass shell momenta is what gives a connection between ordinary virtual momenta and corresponding pseudo-momenta.

1. The weak form of electric-magnetic duality [?] has led to several developments in basic TGD. One important breakthrough was the improved understanding of the generalized eigenvalue spectrum of the Chern-Simons Dirac operator. The generalized eigenvalues have interpretation as pseudo-momenta reducing to the preferred plane  $M^2 \subset M^4$  assignable to  $CD$ . There are good arguments in favor of a discrete spectrum. There are several options between which one must choose. For the simplest option the pseudo-momenta have interpretation as hyper-complex primes and possibly also their powers. The number of the allowed momenta is finite for this option. One can consider also a scenario in which integer multiples of a finite number of hyper-complex primes and their powers are allowed.

The summation over pseudo-momenta has nothing to do with the integration over the ordinary loop momenta. If one accepts the proposed connection with infinite hyper-octonionic (and hyper-complex) primes and corresponding arithmetic quantum field theory, one has separate conservation law for them for each hypercomplex prime defining this kind of pseudo-momentum. In arithmetic QFT the conservation law states that the number of bosons and fermions characterized by given prime is conserved in vertex. This conservation law can be interpreted also in terms of a hierarchy of Planck constants as a conservation law correlating the geometries of the partonic orbits entering the vertex and stating that the number of sheets of the covering of  $CD \times CP_2$  assigned to a given prime is conserved in the vertex although it can be shared between outgoing particles. Therefore pseudo-momenta for the modes of the modified Dirac operator would code for geometric data. This is in accordance with quantum classical correspondence.

2. By bosonic emergence [?] fermionic propagators are the fundamental objects in quantum TGD. The basic implication is that the fermionic propagators reduce to what is formally like a massless fermion propagator for the discrete  $M^2$ -valued pseudo-momenta. The close analogy with

massless theory encourages to consider a possibility of a discrete number theoretic variant of the twistor formalism with  $M^4$  twistors reducing to  $M^2$  twistors. Whether this formalism has any practical value is of course an open question. Irrespective of whether the twistor philosophy is accepted, massless pseudo-momenta should characterize on mass shell states appearing in incoming lines. They would correspond to hyper-complex integers of form  $n \times (1, 1)$  with vanishing norm forming an ideal in the algebra of hyper-complex integers. These integers are expressible as powers of  $(1, 1)$  which therefore defines a prime like object.

3. One can assign to the lines of generalized Feynman diagrams also ordinary momenta and in loops also integrations over ordinary four-momenta are possible. In zero energy ontology however virtual momenta correspond to pairs of in general non-parallel on-mass-shell momenta, which can have also opposite signs of energy. On mass shell property for these momenta implies extremely strong kinematical constraints and only the simplest loops such as self energy loops remain. Super-symmetry gives good hopes that the bosonic and fermionic contributions to these loops vanish by the basic sign difference coming from fermionic statistics since momentum integrals are identical and only pseudo-momentum summations can distinguish between the diagrams.
4. Unitarity poses a crucial constraint on the perturbative approach. One would like to have unitarity in the form of generalized Cutkosky rules [?] . If one assigns ordinary momenta with the lines of the generalized Feynman diagram and if ordinary propagators are replaced with those involving pseudo-momenta, this is however far from obvious. What comes first in mind is that propagators defined by the pseudo-momenta are replaced with their sums with the ordinary on mass shell propagators. Unless pseudo-momentum is massless this modification is trivial. If pseudo-momentum becomes massless the propagator reduces to ordinary massless propagator and the  $i\epsilon$  description might allow to have the correct analytic structure.
5. One can argue that would be somewhat frustrating to have two separate loop momentum summations/integrals and that a more concrete connection between real momenta and pseudo-momenta should therefore exist. One possibility is that the sum or difference of on-mass-shell momenta associated with the wormhole throats defining the loop momentum is equal or at least proportional to the sum or difference of the corresponding pseudo-momenta. Since incoming lines must correspond to massless pseudo-momenta, the sum or difference of ordinary momenta associated with the wormhole throats must be massless. In the case of massive particles this condition makes sense only for the difference of the throat momenta. Hence pseudo-momenta must correspond to the differences of throat momenta.

In this manner the Cutkosky rules would emerge in a more convincing manner from the theory. The restriction of the net loop momenta to plane  $M^2$  and discretization would imply a spontaneous breaking of Lorentz invariance for a given  $CD$  bringing in mind the description of quarks and gluons in terms of longitudinal momenta. This restriction would also improve dramatically the UV behavior and imply finiteness of self energy diagrams even without super-symmetry. It is not clear whether the number theoretic constraints on difference of throat momenta are consistent with the momentum conservation in vertices and it might be that a more general option for which pseudo-momenta are identified as  $M^2$  projections of hyper-octonionic primes must be allowed.

In the following the basic arguments supporting this still speculative picture are described.

### 8.6.2 Generalized eigen modes for the modified Chern-Simons Dirac equation and hydrodynamical picture

Hydrodynamical picture and the reduction of TGD to almost topological QFT discussed in detail in [?] helps to understand also the construction of generalized eigen modes of 3-D Chern-Simons Dirac equation.

### 8.6.3 Generalized Feynman diagrams at fermionic and momentum space level

Negative energy ontology has already led to the idea of interpreting the virtual particles as pairs of positive and negative energy wormhole throats. Hitherto I have taken it as granted that ordinary Feynman diagrammatics generalizes more or less as such. It is however far from clear what really happens in the vertices of the generalized Feynmann diagrams. The safest approach relies on the requirement that unitarity realized in terms of Cutkosky rules in ordinary Feynman diagrammatics allows a generalization. This requires loop diagrams. In particular, photon-photon scattering can take place only via a fermionic square loop so that it seems that loops must be present at least in the topological sense.

One must be however ready for the possibility that something unexpectedly simple might emerge. For instance, the vision about algebraic physics allows naturally only finite sums for diagrams and does not favor infinite perturbative expansions. Hence the true believer on algebraic physics might dream about finite number of diagrams for a given reaction type. For simplicity generalized Feynman diagrams without the complications brought by the magnetic confinement since by the previous arguments the generalization need not bring in anything essentially new.

The basic idea of duality in early hadronic models was that the lines of the dual diagram representing particles are only re-arranged in the vertices. This however does not allow to get rid of off mass shell momenta. Zero energy ontology encourages to consider a stronger form of this principle in the sense that the virtual momenta of particles could correspond to pairs of on mass shell momenta of particles. If also interacting fermions are pairs of positive and negative energy throats in the interaction region the idea about reducing the construction of Feynman diagrams to some kind of lego rules might work.

#### Virtual particles as pairs of on mass shell particles in ZEO

The first thing is to try to define more precisely what generalized Feynman diagrams are. The direct generalization of Feynman diagrams implies that both wormhole throats and wormhole contacts join at vertices.

1. A simple intuitive picture about what happens is provided by diagrams obtained by replacing the points of Feynman diagrams (wormhole contacts) with short lines and imagining that the throats correspond to the ends of the line. At vertices where the lines meet the incoming on mass shell quantum numbers would sum up to zero. This approach leads to a straightforward generalization of Feynman diagrams with virtual particles replaced with pairs of on mass shell throat states of type  $++$ ,  $--$ , and  $+-$ . Incoming lines correspond to  $++$  type lines and outgoing ones to  $--$  type lines. The first two line pairs allow only time like net momenta whereas  $+-$  line pairs allow also space-like virtual momenta. The sign assigned to a given throat is dictated by the the sign of the on mass shell momentum on the line. The condition that Cutkosky rules generalize as such requires  $++$  and  $--$  type virtual lines since the cut of the diagram in Cutkosky rules corresponds to on mass shell outgoing or incoming states and must therefore correspond to  $++$  or  $--$  type lines.
2. The basic difference as compared to the ordinary Feynman diagrammatics is that loop integrals are integrals over mass shell momenta and that all throats carry on mass shell momenta. In each vertex of the loop mass incoming on mass shell momenta must sum up to on mass shell momentum. These constraints improve the behavior of loop integrals dramatically and give excellent hopes about finiteness. It does not however seem that only a finite number of diagrams contribute to the scattering amplitude besides tree diagrams. The point is that if a the reactions  $N_1 \rightarrow N_2$  and  $N_2 \rightarrow N_3$ , where  $N_i$  denote particle numbers, are possible in a common kinematical region for  $N_2$ -particle states then also the diagrams  $N_1 \rightarrow N_2 \rightarrow N_2 \rightarrow N_3$  are possible. The virtual states  $N_2$  include all all states in the intersection of kinematically allow regions for  $N_1 \rightarrow N_2$  and  $N_2 \rightarrow N_3$ . Hence the dream about finite number possible diagrams is not fulfilled if one allows massless particles. If all particles are massive then the particle number  $N_2$  for given  $N_1$  is limited from above and the dream is realized.
3. For instance, loops are not possible in the massless case or are highly singular (bringing in mind twistor diagrams) since the conservation laws at vertices imply that the momenta are parallel.

In the massive case and allowing mass spectrum the situation is not so simple. As a first example one can consider a loop with three vertices and thus three internal lines. Three on mass shell conditions are present so that the four-momentum can vary in 1-D subspace only. For a loop involving four vertices there are four internal lines and four mass shell conditions so that loop integrals would reduce to discrete sums. Loops involving more than four vertices are expected to be impossible.

4. The proposed replacement of the elementary fermions with bound states of elementary fermions and monopoles  $X_{\pm}$  brings in the analog of stringy diagrammatics. The 2-particle wave functions in the momentum degrees of freedom of fermions and  $X_{\pm}$  might allow more flexibility and allow more loops. Note however that there are excellent hopes about the finiteness of the theory also in this case.

**Loop integrals are manifestly finite**

One can make also more detailed observations about loops.

1. The simplest situation is obtained if only 3-vertices are allowed. In this case conservation of momentum however allows only collinear momenta although the signs of energy need not be the same. Particle creation and annihilation is possible and momentum exchange is possible but is always light-like in the massless case. The scattering matrices of supersymmetric YM theories would suggest something less trivial and this raises the question whether something is missing. Magnetic monopoles are an essential element of also these theories as also massivation and symmetry breaking and this encourages to think that the formation of massive states as fermion  $X_{\pm}$  pairs is needed. Of course, in TGD framework one has also high mass excitations of the massless states making the scattering matrix non-trivial.
2. In YM theories on mass shell lines would be singular. In TGD framework this is not the case since the propagator is defined as the inverse of the 3-D dimensional reduction of the modified Dirac operator  $D$  containing also coupling to four-momentum (this is required by quantum classical correspondence and guarantees stringy propagators),

$$\begin{aligned}
 D &= i\hat{\Gamma}^{\alpha}p_{\alpha} + \hat{\Gamma}^{\alpha}D_{\alpha} \ , \\
 p_{\alpha} &= p_k\partial_{\alpha}h^k \ .
 \end{aligned}
 \tag{8.6.1}$$

The propagator does not diverge for on mass shell massless momenta and the propagator lines are well-defined. This is of course of essential importance also in general case. Only for the incoming lines one can consider the possibility that 3-D Dirac operator annihilates the induced spinor fields. All lines correspond to generalized eigenstates of the propagator in the sense that one has  $D_3\Psi = \lambda\gamma\Psi$ , where  $\gamma$  is modified gamma matrix in the direction of the stringy coordinate emanating from light-like surface and  $D_3$  is the 3-dimensional dimensional reduction of the 4-D modified Dirac operator. The eigenvalue  $\lambda$  is analogous to energy. Note that the eigenvalue spectrum depends on 4-momentum as a parameter.

3. Massless incoming momenta can decay to massless momenta with both signs of energy. The integration measure  $d^2k/2E$  reduces to  $dx/x$  where  $x \geq 0$  is the scaling factor of massless momentum. Only light-like momentum exchanges are however possible and scattering matrix is essentially trivial. The loop integrals are finite apart from the possible delicacies related to poles since the loop integrands for given massless wormhole contact are proportional to  $dx/x^3$  for large values of  $x$ .
4. Irrespective of whether the particles are massless or not, the divergences are obtained only if one allows too high vertices as self energy loops for which the number of momentum degrees of freedom is  $3N - 4$  for  $N$ -vertex. The construction of SUSY limit of TGD in [?] led to the conclusion that the parallelly propagating  $N$  fermions for given wormhole throat correspond to a product of  $N$  fermion propagators with same four-momentum so that for fermions and ordinary bosons one has the standard behavior but for  $N > 2$  non-standard so that these excitations are

not seen as ordinary particles. Higher vertices are finite only if the total number  $N_F$  of fermions propagating in the loop satisfies  $N_F > 3N - 4$ . For instance, a 4-vertex from which  $N = 2$  states emanate is finite.

### Taking into account magnetic confinement

What has been said above is not quite enough. The weak form of electric-magnetic duality [?] leads to the picture about elementary particles as pairs of magnetic monopoles inspiring the notions of weak confinement based on magnetic monopole force. Also color confinement would have magnetic counterpart. This means that elementary particles would behave like string like objects in weak boson length scale. Therefore one must also consider the stringy case with wormhole throats replaced with fermion- $X_{\pm}$  pairs ( $X_{\pm}$  is electromagnetically neutral and  $\pm$  refers to the sign of the weak isospin opposite to that of fermion) and their super partners.

1. The simplest assumption in the stringy case is that fermion- $X_{\pm}$  pairs behave as coherent objects, that is scatter elastically. In more general case only their higher excitations identifiable in terms of stringy degrees of freedom would be created in vertices. The massivation of these states makes possible non-collinear vertices. An open question is how the massivation fermion- $X_{\pm}$  pairs relates to the existing TGD based description of massivation in terms of Higgs mechanism and modified Dirac operator.
2. Mass renormalization could come from self energy loops with negative energy lines as also vertex normalization. By very general arguments supersymmetry implies the cancellation of the self energy loops but would allow non-trivial vertex renormalization [?] .
3. If only 3-vertices are allowed, the loops containing only positive energy lines are possible if on mass shell fermion- $X_{\pm}$  pair (or its superpartner) can decay to a pair of positive energy pair particles of same kind. Whether this is possible depends on the masses involved. For ordinary particles these decays are not kinematically possible below intermediate boson mass scale (the decays  $F_1 \rightarrow F_2 + \gamma$  are forbidden kinematically or by the absence of flavor changing neutral currents whereas intermediate gauge bosons can decay to on mass shell fermion-antifermion pair).
4. The introduction of IR cutoff for 3-momentum in the rest system associated with the largest  $CD$  (causal diamond) looks natural as scale parameter of coupling constant evolution and p-adic length scale hypothesis favors the inverse of the size scale of  $CD$  coming in powers of two. This parameter would define the momentum resolution as a discrete parameter of the p-adic coupling constant evolution. This scale does not have any counterpart in standard physics. For electron,  $d$  quark, and  $u$  quark the proper time distance between the tips of  $CD$  corresponds to frequency of 10 Hz, 1280 Hz, and 160 Hz: all these frequencies define fundamental bio-rhythms [K22] .

These considerations have left completely untouched one important aspect of generalized Feynman diagrams: the necessity to perform a functional integral over the deformations of the partonic 2-surfaces at the ends of the lines- that is integration over WCW. Number theoretical universality requires that WCW and these integrals make sense also p-adically and in the following these aspects of generalized Feynman diagrams are discussed.

### The general form of generalized eigenvalue equation for Chern-Simons Dirac action

Consider first the the general form and interpretation of the generalized eigenvalue equation assigned with the modified Dirac equation for Chern-Simons action [K15] . This is of course only an approximation since an additional contribution to the modified gamma matrices from the Lagrangian multiplier term guaranteing the weak form of electric-magnetic duality must be included.

1. The modified Dirac equation for  $\Psi$  is consistent with that for its conjugate if the coefficient of the instanton term is real and one uses the Dirac action  $\bar{\Psi}(D^{\rightarrow} - D^{\leftarrow})\Psi$  giving modified Dirac equation as

$$D_{C-S}\Psi + \frac{1}{2}(D_{\alpha}\hat{\Gamma}_{C-S}^{\alpha})\Psi = 0 . \quad (8.6.2)$$



As noticed, the divergence  $D_\alpha \hat{\Gamma}_{C-S}^\alpha$  does not contain second derivatives in the case of Chern-Simons action. In the case of Kähler action they occur unless field equations equivalent with the vanishing of the divergence term are satisfied. The extremals of Chern-Simons action provide a natural manner to define effective 2-dimensionality.

Also the fermionic current is conserved in this case, which conforms with the idea that fermions flow along the light-like 3-surfaces. If one uses the action  $\bar{\Psi} D \rightarrow \Psi$ ,  $\bar{\Psi}$  does not satisfy the Dirac equation following from the variational principle and fermion current is not conserved.

2. The generalized eigen modes of  $D_{C-S}$  should be such that one obtains the counterpart of Dirac propagator which is purely algebraic and does not therefore depend on the coordinates of the throat. This is satisfied if the generalized eigenvalues are expressible in terms of covariantly constant combinations of gamma matrices and here only  $M^4$  gamma matrices are possible. Therefore the eigenvalue equation would read as

$$D\Psi = \lambda^k \gamma_k \Psi, \quad D = D_{C-S} + \frac{1}{2} D_\alpha \hat{\Gamma}_{C-S}^\alpha, \quad D_{C-S} = \hat{\Gamma}_{C-S}^\alpha D_\alpha. \tag{8.6.3}$$

Here the covariant derivatives  $D_\alpha$  contain the measurement interaction term as an apparent gauge term. For extremals one has

$$D = D_{C-S}. \tag{8.6.4}$$

Covariant constancy allows to take the square of this equation and one has

$$(D^2 + [D, \lambda^k \gamma_k])\Psi = \lambda^k \lambda_k \Psi. \tag{8.6.5}$$

The commutator term is analogous to magnetic moment interaction.

3. The generalized eigenvalues correspond to  $\lambda = \sqrt{\lambda^k \lambda_k}$  and Dirac determinant is defined as a product of the eigenvalues and conjecture to give the exponent of Kähler action reducing to Chern-Simons term.  $\lambda$  is completely analogous to mass.  $\lambda_k$  cannot be however interpreted as ordinary four-momentum: for instance, number theoretic arguments suggest that  $\lambda_k$  must be restricted to the preferred plane  $M^2 \subset M^4$  interpreted as a commuting hyper-complex plane of complexified quaternions. For incoming lines this mass would vanish so that all incoming particles irrespective their actual quantum numbers would be massless in this sense and the propagator is indeed that for a massless particle. Note that the eigen-modes define the boundary values for the solutions of  $D_K \Psi = 0$  so that the values of  $\lambda$  indeed define the counterpart of the momentum space.

This transmutation of massive particles to effectively massless ones might make possible the application of the twistor formalism as such in TGD framework [?] .  $N = 4$  SUSY is one of the very few gauge theory which might be UV finite but it is definitely unphysical due to the masslessness of the basic quanta. Could the resolution of the interpretational problems be that the four-momenta appearing in this theory do not directly correspond to the observed four-momenta?

**Inclusion of the constraint term**

As already noticed one must include also the constraint term due to the weak form of electric-magnetic duality and this changes somewhat the above simple picture.

1. At the 3-dimensional ends of the space-time sheet and at wormhole throats the 3-dimensionality allows to introduce a coordinate varying along the flow lines of Kähler magnetic field  $B = *J$ . In this case the integrability conditions state that the flow is Beltrami flow. Note that the value of  $B^\alpha$  along the flow line defining magnetic flux appearing in anti-commutation relations is constant. This suggests that the generalized eigenvalue equation for the Chern-Simons action reduces to a collection of ordinary apparently independent differential equations associated with the flow lines beginning from the partonic 2-surface. This indeed happens when the  $CP_2$  projection is 2-dimensional. In this case it however seems that the basis  $u_n$  is not of much help.
2. The conclusion is wrong: the variations of Chern-Simons action are subject to the constraint that electric-magnetic duality holds true expressible in terms of Lagrange multiplier term

$$\int \Lambda_\alpha (J^{n\alpha} - K \epsilon^{n\alpha\beta\gamma} J_{\beta\gamma}) \sqrt{g_4} d^3 x . \quad (8.6.6)$$

This gives a constraint force to the field equations and also a dependence on the induced 4-metric so that one has only almost topological QFT. This term also guarantees the  $M^4$  part of WCW Kähler metric is non-trivial. The condition that the ends of space-time sheet and wormhole throats are extrema of Chern-Simons action subject to the electric-magnetic duality constraint is strongly suggested by the effective 2-dimensionality. Without the constraint term Chern-Simons action would vanish for its extremals so that Kähler function would be identically zero.

This term implies also an additional contribution to the modified gamma matrices besides the contribution coming from Chern-Simons action so that the first guess for the modified Dirac operator would not be quite correct. This contribution is of exactly of the same general form as the contribution for any general general coordinate invariant action. The dependence of the induced metric on  $M^4$  degrees of freedom guarantees that also  $M^4$  gamma matrices are present. In the following this term will not be considered.

3. When the contribution of the constraint term to the modified gamma matrices is neglected, the explicit expression of the modified Dirac operator  $D_{C-S}$  associated with the Chern-Simons term is given by

$$\begin{aligned} D &= \hat{\Gamma}^\mu D_\mu + \frac{1}{2} D_\mu \hat{\Gamma}^\mu , \\ \hat{\Gamma}^\mu &= \frac{\partial L_{C-S}}{\partial_\mu h^k} \Gamma_k = \epsilon^{\mu\alpha\beta} [2J_{kl} \partial_\alpha h^l A_\beta + J_{\alpha\beta} A_k] \Gamma^k D_\mu , \\ D_\mu \hat{\Gamma}^\mu &= B_K^\alpha (J_{k\alpha} + \partial_\alpha A_k) , \\ B_K^\alpha &= \epsilon^{\alpha\beta\gamma} J_{\beta\gamma} , \quad J_{k\alpha} = J_{kl} \partial_\alpha s^l , \quad \hat{\epsilon}^{\alpha\beta\gamma} = \epsilon^{\alpha\beta\gamma} \sqrt{g_3} . \end{aligned} \quad (8.6.7)$$

For the extremals of Chern-Simons action one has  $D_\alpha \hat{\Gamma}^\alpha = 0$ . Analogous condition holds true when the constraining contribution to the modified gamma matrices is added.

### Generalized eigenvalue equation for Chern-Simons Dirac action

Consider now the Chern-Simons Dirac equation in more detail assuming that the inclusion of the constraint contribution to the modified gamma matrices does not induce any complications. Assume also extremal property for Chern-Simons action with constraint term and Beltrami flow property.

1. For the extremals the Chern-Simons Dirac operator (constraint term not included) reduces to a one-dimensional Dirac operator

$$D_{C-S} = \hat{\epsilon}^{r\alpha\beta} [2J_{k\alpha} A_\beta + J_{\alpha\beta} A_k] \Gamma^k D_r . \quad (8.6.8)$$

Constraint term implies only a modification of the modified gamma matrices but the form of the operator remains otherwise same when extrema are in question so that one has  $D_\alpha \hat{\Gamma}^\alpha = 0$ .

2. For the extremals of Chern-Simons action the general solution of the modified Chern-Simons Dirac equation ( $\lambda^k = 0$ ) is covariantly constant with respect to the coordinate  $r$ :

$$D_r \Psi = 0 . \tag{8.6.9}$$

The solution to this condition can be written immediately in terms of a non-integrable phase factor  $P \exp(i \int A_r dr)$ , where integration is along curve with constant transversal coordinates. If  $\hat{\Gamma}^v$  is light-like vector field also  $\hat{\Gamma}^v \Psi_0$  defines a solution of  $D_{C-S}$ . This solution corresponds to a zero mode for  $D_{C-S}$  and does not contribute to the Dirac determinant (suggested to give rise to the exponent of Kähler function identified as Kähler action). Note that the dependence of these solutions on transversal coordinates of  $X_i^3$  is arbitrary which conforms with the hydrodynamic picture. The solutions of Chern-Simons-Dirac are obtained by similar integration procedure also when extremals are not in question.

The formal solution associated with a general eigenvalue  $\lambda$  can be constructed by integrating the eigenvalue equation separately along all coordinate curves. This makes sense if  $r$  indeed assigned to possibly light-like flow lines of  $B^\alpha$  or more general Beltrami field possible induced by the constraint term. There are very strong consistency conditions coming from the conditions that  $\Psi$  in the interior is constant along the flow lines of Kähler current and continuous at the ends and throats (call them collectively boundaries), where  $\Psi$  has a non-trivial variation along the flow lines of  $B^\alpha$ .

1. This makes sense only if the flow lines of the Kähler current are transversal to the boundaries so that the spinor modes at boundaries dictate the modes of the spinor field in the interior. Effective 2-dimensionality means that the spinor modes in the interior can be calculated either by starting from the throats or from the ends so that the data at either upper or lower partonic 2-surfaces dictates everything in accordance with zero energy ontology.
2. This gives an infinite number of commuting diagrams stating that the flow-line time evolution along flow lines along wormhole throats from lower partonic 2-surface to the upper one is equivalent with the flow-line time evolution along the lower end of space-time surface to interior, then along interior to the upper end of the space-time surface and then back to the upper partonic 2-surface. If the space-time surface allows a slicing by partonic 2-surfaces these conditions can be assumed for any pair of partonic 2-surfaces connected by Chern-Simons flow evolution.
3. Since the time evolution along interior keeps the spinor field as constant in the proper gauge and since the flow evolutions at the lower and upper ends are in a reverse direction, there is a strong attemptation to assume that the spinor field at the ends of the of the flow lines of Kähler magnetic field are identical apart from a gauge transformation. This leads to a particle-in-box quantization of the values of the pseudo-mass (periodic boundary conditions). These conditions will be assumed in the sequel.

These assumptions lead to the following picture about the generalized eigen modes.

1. By choosing the gauge so that covariant derivative reduces to ordinary derivative and using the constancy of  $\hat{\Gamma}^r$ , the solution of the generalized eigenvalue equation can be written as

$$\begin{aligned} \Psi &= \exp(iL(r)\hat{\Gamma}^r \lambda^k \Gamma_k) \Psi_0 , \\ L(r) &= \int_0^r \frac{1}{\sqrt{\hat{g}^{rr}}} dr . \end{aligned} \tag{8.6.10}$$

$L(r)$  can be regarded as the along flux line as defined by the effective metric defined by modified gamma matrices. If  $\lambda_k$  is linear combination of  $\Gamma^0$  and  $\Gamma^{r_M}$  it anti-commutes with  $\Gamma^r$  which contains only  $CP_2$  gamma matrices so that the pseudo-momentum is a priori arbitrary.

2. When the constraint term taking care of the electric-magnetic duality is included, also  $M^4$  gamma matrices are present. If they are in the orthogonal complement of a preferred plane  $M^2 \subset M^4$ , anti-commutativity is achieved. This assumption cannot be fully justified yet but conforms with the general physical vision. There is an obvious analogy with the condition that polarizations are in a plane orthogonal to  $M^2$ . The condition indeed states that only transversal deformations define quantum fluctuating WCW degrees of freedom contributing to the WCW Kähler metric. In  $M^8-H$  duality the preferred plane  $M^2$  is interpreted as a hyper-complex plane belonging to the tangent space of the space-time surface and defines the plane of non-physical polarizations. Also a generalization of this plane to an integrable distribution of planes  $M^2(x)$  has been proposed and one must consider also now the possibility of a varying plane  $M^2(x)$  for the pseudo-momenta. The scalar function  $\Phi$  appearing in the general solution ansatz for the field equations satisfies massless d'Alembert equation and its gradient defines a local light-like direction at space-time-level and hence a 2-D plane of the tangent space. Maybe the projection of this plane to  $M^4$  could define the preferred  $M^2$ . The minimum condition is that these planes are defined only at the ends of space-time surface and at wormhole throats.
3. If one accepts this hypothesis, one can write

$$\begin{aligned}\Psi &= \left[ \cos(L(r)\lambda) + i \sin(\lambda(r)) \hat{\Gamma}^r \lambda^k \Gamma_k \right] \Psi_0, \\ \lambda &= \sqrt{\lambda_k \lambda^k}.\end{aligned}\tag{8.6.11}$$

4. Boundary conditions should fix the spectrum of masses. If the the flow lines of Kähler current coincide with the flow lines of Kähler magnetic field or more general Beltrami current at wormhole throats one ends up with difficulties since the induced spinor fields must be constant along flow lines and only trivial eigenvalues are possible. Hence it seems that the two Beltrami fields must be transversal. This requires that at the partonic 2-surfaces the value of the induced spinor mode in the interior coincides with its value at the throat. Since the induced spinor fields in interior are constant along flow lines, one must have

$$\exp(i\lambda L_{(max)}) = 1.\tag{8.6.12}$$

This implies that one has essentially particle in a box with size defined by the effective metric

$$\lambda_n = \frac{n2\pi}{L(r_{max})}.\tag{8.6.13}$$

5. This condition cannot however hold true simultaneously for all points of the partonic 2-surfaces since  $L(r_{max})$  depends on the point of the surface. In the most general case one can consider only a subset consisting of the points for which the values of  $L(r_{max})$  are rational multiples of the value of  $L(r_{max})$  at one of the points -call it  $L_0$ . This implies the notion of number theoretical braid. Induced spinor fields are localized to the points of the braid defined by the flow lines of the Kähler magnetic field (or equivalently, any conserved current- this resolves the longstanding issue about the identification of number theoretical braids). The number of the included points depends on measurement resolution characterized somehow by the number rationals which are allowed. Only finite number of harmonics and sub-harmonics of  $L_0$  are possible so that for integer multiples the number of points is finite. If  $n_{max}L_0$  and  $L_0/n_{min}$  are the largest and smallest lengths involved, one can argue that the rationals  $n_{max}/n$ ,  $n = 1, \dots, n_{max}$  and  $n/n_{min}$ ,  $n = 1, \dots, n_{min}$  are the natural ones.

6. One can consider also algebraic extensions for which  $L_0$  is scaled from its reference value by an algebraic number so that the mass scale  $m$  must be scaled up in similar manner. The spectrum comes also now in integer multiples. p-Adic mass calculations predicts mass scales to the inverses of square roots of prime and this raises the expectation that  $\sqrt{n}$  harmonics and sub-harmonics of  $L_0$  might be necessary. Notice however that pseudo-momentum spectrum is in question so that this argument is on shaky grounds.

There is also the question about the allowed values of  $(\lambda_0, \lambda_3)$  for a given value of  $\lambda$ . This issue will be discussed in the next section devoted to the attempt to calculate the Dirac determinant assignable to this spectrum: suffice it to say that integer valued spectrum is the first guess implying that the pseudo-momenta satisfy  $n_0^2 - n_3^2 = n^2$  and therefore correspond to Pythagorean triangles. What is remarkable that the notion of number theoretic braid pops up automatically from the Beltrami flow hypothesis.

### 8.6.4 Hyper-octonionic primes

Before detailed discussion of the hyper-octonionic option it is good to consider the basic properties of hyper-octonionic primes.

1. Hyper-octonionic primes are of form

$$\Pi_p = (n_0, n_3, n_1, n_2, \dots, n_7) , \quad \Pi_p^2 = n_0^2 - \sum_i n_i^2 = p \text{ or } p^2 . \tag{8.6.14}$$

2. Hyper-octonionic primes have a standard representation as hyper-complex primes. The Minkowski norm squared factorizes into a product as

$$n_0^2 - n_3^2 = (n_0 + n_3)(n_0 - n_3) . \tag{8.6.15}$$

If one has  $n_3 \neq 0$ , the prime property implies  $n_0 - n_3 = 1$  so that one obtains  $n_0 = n_3 + 1$  and  $2n_3 + 1 = p$  giving

$$(n_0, n_3) = ((p + 1)/2, (p - 1)/2) . \tag{8.6.16}$$

Note that one has  $(p + 1)/2$  odd for  $p \text{ mod } 4 = 1$  and  $(p + 1)/2$  even for  $p \text{ mod } 4 = 3$ . The difference  $n_0 - n_3 = 1$  characterizes prime property.

If  $n_3$  vanishes the prime property implies equivalence with ordinary prime and one has  $n_0^2 = p^2$ . These hyper-octonionic primes represent particles at rest.

3. The action of a discrete subgroup  $G(p)$  of the octonionic automorphism group  $G_2$  generates form hyper-complex primes with  $n_3 \neq 0$  further hyper-octonionic primes  $\Pi(p, k)$  corresponding to the same value of  $n_0$  and  $p$  and for these the integer valued projection to  $M^2$  satisfies  $n_0^2 - n_3^2 = n > p$ . It is also possible to have a state representing the system at rest with  $(n_0, n_3) = ((p + 1)/2, 0)$  so that the pseudo-mass varies in the range  $[\sqrt{p}, (p + 1)/2]$ . The subgroup  $G(n_0, n_3) \subset SU(3)$  leaving invariant the projection  $(n_0, n_3)$  generates the hyper-octonionic primes corresponding to the same value of mass for hyper-octonionic primes with same Minkowskian length  $p$  and pseudo-mass  $\lambda = n \geq \sqrt{p}$ .
4. One obtains two kinds of primes corresponding to the lengths of pseudo-momenta equal to  $p$  or  $\sqrt{p}$ . The first kind of particles are always at rest whereas the second kind of particles can be brought at rest only if one interprets the pseudo-momentum as  $M^2$  projection. This brings in mind the secondary p-adic length scales assigned to causal diamonds (CDs) and the primary p-adic lengths scales assigned to particles.

If the  $M^2$  projections of hyper-octonionic primes with length  $\sqrt{p}$  characterize the allowed basic momenta,  $\zeta_D$  is sum of zeta functions associated with various projections which must be in the limits dictated by the geometry of the orbit of the partonic surface giving upper and lower bounds  $L_{max}$  and  $L_{min}$  on the length  $L$ .  $L_{min}$  is scaled up to  $\sqrt{n_0^2 - n_3^2} L_{min}$  for a given projection  $(n_0, n_3)$ . In general a given  $M^2$  projection  $(n_0, n_3)$  corresponds to several hyper-octonionic primes since  $SU(3)$  rotations give a new hyper-octonionic prime with the same  $M^2$  projection. This leads to an inconsistency unless one has a good explanation for why some basic momentum can appear several times. One might argue that the spinor mode is degenerate due to the possibility to perform discrete color rotations of the state. For hyper complex representatives there is no such problem and it seems favored. In any case, one can look how the degeneracy factors for given projection can be calculated.

1. To calculate the degeneracy factor  $D(n)$  associated with given pseudo-mass value  $\lambda = n$  one must find all hyper-octonionic primes  $\Pi$ , which can have projection in  $M^2$  with length  $n$  and sum up the degeneracy factors  $D(n, p)$  associated with them:

$$\begin{aligned} D(n) &= \sum_p D(n, p) \ , \\ D(n, p) &= \sum_{n_0^2 - n_3^2 = p} D(p, n_0, n_3) \ , \\ n_0^2 - n_3^2 &= n \ , \quad \Pi_p^2(n_0, n_3) = n_0^2 - n_3^2 - \sum_i n_i^2 = n - \sum_i n_i^2 = p \ . \end{aligned} \quad (8.6.17)$$

2. The condition  $n_0^2 - n_3^2 = n$  allows only Pythagorean triangles and one must find the discrete subgroup  $G(n_0, n_3) \subset SU(3)$  producing hyper-octonions with integer valued components with length  $p$  and components  $(n_0, n_3)$ . The points at the orbit satisfy the condition

$$\sum_i n_i^2 = p - n \ . \quad (8.6.18)$$

The degeneracy factor  $D(p, n_0, n_3)$  associated with given mass value  $n$  is the number of elements of in the coset space  $G(n_0, n_3, p)/H(n_0, n_3, p)$ , where  $H(n_0, n_3, p)$  is the isotropy group of given hyper-octonionic prime obtained in this manner. For  $n_0^2 - n_3^2 = p^2$   $D(n_0, n_3, p)$  obviously equals to unity.

### 8.6.5 Generalized Feynman diagrams at fermionic and momentum space level

Negative energy ontology has already led to the idea of interpreting the virtual particles as pairs of positive and negative energy wormhole throats. Hitherto I have taken it as granted that ordinary Feynman diagrammatics generalizes more or less as such. It is however far from clear what really happens in the vertices of the generalized Feynmann diagrams. The safest approach relies on the requirement that unitarity realized in terms of Cutkosky rules in ordinary Feynman diagrammatics allows a generalization. This requires loop diagrams. In particular, photon-photon scattering can take place only via a fermionic square loop so that it seems that loops must be present at least in the topological sense.

One must be however ready for the possibility that something unexpectedly simple might emerge. For instance, the vision about algebraic physics allows naturally only finite sums for diagrams and does not favor infinite perturbative expansions. Hence the true believer on algebraic physics might dream about finite number of diagrams for a given reaction type. For simplicity generalized Feynman diagrams without the complications brought by the magnetic confinement since by the previous arguments the generalization need not bring in anything essentially new.

The basic idea of duality in early hadronic models was that the lines of the dual diagram representing particles are only re-arranged in the vertices. This however does not allow to get rid of off

mass shell momenta. Zero energy ontology encourages to consider a stronger form of this principle in the sense that the virtual momenta of particles could correspond to pairs of on mass shell momenta of particles. If also interacting fermions are pairs of positive and negative energy throats in the interaction region the idea about reducing the construction of Feynman diagrams to some kind of lego rules might work.

### Virtual particles as pairs of on mass shell particles in ZEO

The first thing is to try to define more precisely what generalized Feynman diagrams are. The direct generalization of Feynman diagrams implies that both wormhole throats and wormhole contacts join at vertices.

1. A simple intuitive picture about what happens is provided by diagrams obtained by replacing the points of Feynman diagrams (wormhole contacts) with short lines and imagining that the throats correspond to the ends of the line. At vertices where the lines meet the incoming on mass shell quantum numbers would sum up to zero. This approach leads to a straightforward generalization of Feynman diagrams with virtual particles replaced with pairs of on mass shell throat states of type  $++$ ,  $--$ , and  $+-$ . Incoming lines correspond to  $++$  type lines and outgoing ones to  $--$  type lines. The first two line pairs allow only time like net momenta whereas  $+-$  line pairs allow also space-like virtual momenta. The sign assigned to a given throat is dictated by the the sign of the on mass shell momentum on the line. The condition that Cutkosky rules generalize as such requires  $++$  and  $--$  type virtual lines since the cut of the diagram in Cutkosky rules corresponds to on mass shell outgoing or incoming states and must therefore correspond to  $++$  or  $--$  type lines.
2. The basic difference as compared to the ordinary Feynman diagrammatics is that loop integrals are integrals over mass shell momenta and that all throats carry on mass shell momenta. In each vertex of the loop mass incoming on mass shell momenta must sum up to on mass shell momentum. These constraints improve the behavior of loop integrals dramatically and give excellent hopes about finiteness. It does not however seem that only a finite number of diagrams contribute to the scattering amplitude besides tree diagrams. The point is that if a the reactions  $N_1 \rightarrow N_2$  and  $N_2 \rightarrow N_3$ , where  $N_i$  denote particle numbers, are possible in a common kinematical region for  $N_2$ -particle states then also the diagrams  $N_1 \rightarrow N_2 \rightarrow N_2 \rightarrow N_3$  are possible. The virtual states  $N_2$  include all all states in the intersection of kinematically allow regions for  $N_1 \rightarrow N_2$  and  $N_2 \rightarrow N_3$ . Hence the dream about finite number possible diagrams is not fulfilled if one allows massless particles. If all particles are massive then the particle number  $N_2$  for given  $N_1$  is limited from above and the dream is realized.
3. For instance, loops are not possible in the massless case or are highly singular (bringing in mind twistor diagrams) since the conservation laws at vertices imply that the momenta are parallel. In the massive case and allowing mass spectrum the situation is not so simple. As a first example one can consider a loop with three vertices and thus three internal lines. Three on mass shell conditions are present so that the four-momentum can vary in 1-D subspace only. For a loop involving four vertices there are four internal lines and four mass shell conditions so that loop integrals would reduce to discrete sums. Loops involving more than four vertices are expected to be impossible.
4. The proposed replacement of the elementary fermions with bound states of elementary fermions and monopoles  $X_{\pm}$  brings in the analog of stringy diagrammatics. The 2-particle wave functions in the momentum degrees of freedom of fermions and  $X_{\pm}$  might allow more flexibility and allow more loops. Note however that there are excellent hopes about the finiteness of the theory also in this case.

### Loop integrals are manifestly finite

One can make also more detailed observations about loops.

1. The simplest situation is obtained if only 3-vertices are allowed. In this case conservation of momentum however allows only collinear momenta although the signs of energy need not be

the same. Particle creation and annihilation is possible and momentum exchange is possible but is always light-like in the massless case. The scattering matrices of supersymmetric YM theories would suggest something less trivial and this raises the question whether something is missing. Magnetic monopoles are an essential element of also these theories as also massivation and symmetry breaking and this encourages to think that the formation of massive states as fermion  $X_{\pm}$  pairs is needed. Of course, in TGD framework one has also high mass excitations of the massless states making the scattering matrix non-trivial.

2. In YM theories on mass shell lines would be singular. In TGD framework this is not the case since the propagator is defined as the inverse of the 3-D dimensional reduction of the modified Dirac operator  $D$  containing also coupling to four-momentum (this is required by quantum classical correspondence and guarantees stringy propagators),

$$\begin{aligned} D &= i\hat{\Gamma}^{\alpha}p_{\alpha} + \hat{\Gamma}^{\alpha}D_{\alpha} \ , \\ p_{\alpha} &= p_k\partial_{\alpha}h^k \ . \end{aligned} \tag{8.6.19}$$

The propagator does not diverge for on mass shell massless momenta and the propagator lines are well-defined. This is of course of essential importance also in general case. Only for the incoming lines one can consider the possibility that 3-D Dirac operator annihilates the induced spinor fields. All lines correspond to generalized eigenstates of the propagator in the sense that one has  $D_3\Psi = \lambda\gamma\Psi$ , where  $\gamma$  is modified gamma matrix in the direction of the stringy coordinate emanating from light-like surface and  $D_3$  is the 3-dimensional dimensional reduction of the 4-D modified Dirac operator. The eigenvalue  $\lambda$  is analogous to energy. Note that the eigenvalue spectrum depends on 4-momentum as a parameter.

3. Massless incoming momenta can decay to massless momenta with both signs of energy. The integration measure  $d^2k/2E$  reduces to  $dx/x$  where  $x \geq 0$  is the scaling factor of massless momentum. Only light-like momentum exchanges are however possible and scattering matrix is essentially trivial. The loop integrals are finite apart from the possible delicacies related to poles since the loop integrands for given massless wormhole contact are proportional to  $dx/x^3$  for large values of  $x$ .
4. Irrespective of whether the particles are massless or not, the divergences are obtained only if one allows too high vertices as self energy loops for which the number of momentum degrees of freedom is  $3N - 4$  for  $N$ -vertex. The construction of SUSY limit of TGD in [?] led to the conclusion that the parallelly propagating  $N$  fermions for given wormhole throat correspond to a product of  $N$  fermion propagators with same four-momentum so that for fermions and ordinary bosons one has the standard behavior but for  $N > 2$  non-standard so that these excitations are not seen as ordinary particles. Higher vertices are finite only if the total number  $N_F$  of fermions propagating in the loop satisfies  $N_F > 3N - 4$ . For instance, a 4-vertex from which  $N = 2$  states emanate is finite.

### Taking into account magnetic confinement

What has been said above is not quite enough. The weak form of electric-magnetic duality [?] leads to the picture about elementary particles as pairs of magnetic monopoles inspiring the notions of weak confinement based on magnetic monopole force. Also color confinement would have magnetic counterpart. This means that elementary particles would behave like string like objects in weak boson length scale. Therefore one must also consider the stringy case with wormhole throats replaced with fermion- $X_{\pm}$  pairs ( $X_{\pm}$  is electromagnetically neutral and  $\pm$  refers to the sign of the weak isospin opposite to that of fermion) and their super partners.

1. The simplest assumption in the stringy case is that fermion- $X_{\pm}$  pairs behave as coherent objects, that is scatter elastically. In more general case only their higher excitations identifiable in terms of stringy degrees of freedom would be created in vertices. The massivation of these states makes possible non-collinear vertices. An open question is how the massivation fermion- $X_{\pm}$  pairs relates to the existing TGD based description of massivation in terms of Higgs mechanism and modified Dirac operator.



2. Mass renormalization could come from self energy loops with negative energy lines as also vertex normalization. By very general arguments supersymmetry implies the cancellation of the self energy loops but would allow non-trivial vertex renormalization [?] .
3. If only 3-vertices are allowed, the loops containing only positive energy lines are possible if on mass shell fermion- $X_{\pm}$  pair (or its superpartner) can decay to a pair of positive energy pair particles of same kind. Whether this is possible depends on the masses involved. For ordinary particles these decays are not kinematically possible below intermediate boson mass scale (the decays  $F_1 \rightarrow F_2 + \gamma$  are forbidden kinematically or by the absence of flavor changing neutral currents whereas intermediate gauge bosons can decay to on mass shell fermion-antifermion pair).
4. The introduction of IR cutoff for 3-momentum in the rest system associated with the largest  $CD$  (causal diamond) looks natural as scale parameter of coupling constant evolution and p-adic length scale hypothesis favors the inverse of the size scale of  $CD$  coming in powers of two. This parameter would define the momentum resolution as a discrete parameter of the p-adic coupling constant evolution. This scale does not have any counterpart in standard physics. For electron,  $d$  quark, and  $u$  quark the proper time distance between the tips of  $CD$  corresponds to frequency of 10 Hz, 1280 Hz, and 160 Hz: all these frequencies define fundamental bio-rhythms [K22] .

These considerations have left completely untouched one important aspect of generalized Feynman diagrams: the necessity to perform a functional integral over the deformations of the partonic 2-surfaces at the ends of the lines- that is integration over WCW. Number theoretical universality requires that WCW and these integrals make sense also p-adically and in the following these aspects of generalized Feynman diagrams are discussed.

### 8.6.6 Three basic options for the pseudo-momentum spectrum

The calculation of the scaling factor of the Kähler function requires the knowledge of the degeneracies of the mass squared eigen values. There are three options to consider.

#### First option: all pseudo-momenta are allowed

If the degeneracy for pseudo-momenta in  $M^2$  is same for all mass values- and formally characterizable by a number  $N$  telling how many 2-D pseudo-momenta reside on mass shell  $n_0^2 - n_3^2 = m^2$ . In this case zeta function would be proportional to a sum of Riemann Zetas with scaled arguments corresponding to scalings of the basic mass  $m$  to  $m/q$ .

$$\zeta_D(s) = N \sum_q \zeta(\log(qx)s) , \quad x = \frac{L_{min}}{R} . \tag{8.6.20}$$

This option provides no idea about the possible values of  $1 \leq q \leq L_{max}/L_{min}$ . The number  $N$  is given by the integral of relativistic density of states  $\int dk/2\sqrt{k^2 + m^2}$  over the hyperbola and is logarithmically divergent so that the normalization factor  $N$  of the Kähler function would be infinite.

#### Second option: All integer valued pseudomomenta are allowed

Second option is inspired by number theoretic vision and assumes integer valued components for the momenta using  $m_{max} = 2\pi/L_{min}$  as mass unit. p-Adicization motivates also the assumption that momentum components using  $m_{max}$  as mass scale are integers. This would restrict the choice of the number theoretical braids.

Integer valuedness together with masses coming as integer multiples of  $m_{max}$  implies  $(\lambda_0, \lambda_3) = (n_0, n_3)$  with on mass shell condition  $n_0^2 - n_3^2 = n^2$ . Note that the condition is invariant under scaling. These integers correspond to Pythagorean triangles plus the degenerate situation with  $n_3 = 0$ . There exists a finite number of pairs  $(n_0, n_3)$  satisfying this condition as one finds by expressing  $n_0$  as  $n_0 = n_3 + k$  giving  $2n_3k + k^2 = p^2$  giving  $n_3 < n^2/2, n_0 < n^2/2 + 1$ . This would be enough to have a finite degeneracy  $D(n) \geq 1$  for a given value of mass squared and  $\zeta_D$  would be well defined.  $\zeta_D$  would be a modification of Riemann zeta given by

$$\zeta_D = \sum_q \zeta_1(\log(qx)s) , \quad x = \frac{L_{min}}{R} ,$$

$$\zeta_1(s) = \sum g_n n^{-s} , \quad g_n \geq 1 . \quad (8.6.21)$$

For generalized Feynman diagrams this option allows conservation of pseudo-momentum and for loops no divergences are possible since the integral over two-dimensional virtual momenta is replaced with a sum over discrete mass shells containing only a finite number of points. This option looks thus attractive but requires a regularization. On the other hand, the appearance of a zeta function having a strong resemblance with Riemann zeta could explain the finding that Riemann zeta is closely related to the description of critical systems. This point will be discussed later.

### Third option: Infinite primes code for the allowed mass scales

According to the proposal of [?] , [?] the hyper-complex parts of hyper-octonionic primes appearing in their infinite counterparts correspond to the  $M^2$  projections of real four-momenta. This hypothesis suggests a very detailed map between infinite primes and standard model quantum numbers and predicts a universal mass spectrum [?] . Since pseudo-momenta are automatically restricted to the plane  $M^2$ , one cannot avoid the question whether they could actually correspond to the hyper-octonionic primes defining the infinite prime. These interpretations need not of course exclude each other. This option allows several variants and at this stage it is not possible to exclude any of these options.

1. One must choose between two alternatives for which pseudo-momentum corresponds to hyper-complex prime serving as a canonical representative of a hyper-octonionic prime or a projection of hyper-octonionic prime to  $M^2$ .
2. One must decide whether one allows a) only the momenta corresponding to hyper-complex primes, b) also their powers (p-adic fractality), or c) all their integer multiples ("Riemann option").

One must also decide what hyper-octonionic primes are allowed.

1. The first guess is that all hyper-complex/hyper-octonionic primes defining length scale  $\sqrt{p}L_{min} \leq L_{max}$  or  $pL_{min} \leq L_{max}$  are allowed. p-Adic fractality suggests that also the higher p-adic length scales  $p^{n/2}L_{min} < L_{max}$  and  $p^n L_{min} < L_{max}$ ,  $n \geq 1$ , are possible.

It can however happen that no primes are allowed by this criterion. This would mean vanishing Kähler function which is of course also possible since Kähler action can vanish (for instance, for massless extremals). It seems therefore safer to allow also the scale corresponding to the trivial prime  $(n_0, n_3) = (1, 0)$  (1 is formally prime because it is not divisible by any prime different from 1) so that at least  $L_{min}$  is possible. This option also allows only rather small primes unless the partonic 2-surface contains vacuum regions in which case  $L_{max}$  is infinite: in this case all primes would be allowed and the exponent of Kähler function would vanish.

2. The hypothesis that only the hyper-complex or hyper-octonionic primes appearing in the infinite hyper-octonionic prime are possible looks more reasonable since large values of  $p$  would be possible and could be identified in terms of the p-adic length scale hypothesis. All hyper-octonionic primes appearing in infinite prime would be possible and the geometry of the orbit of the partonic 2-surface would define an infinite prime. This would also give a concrete physical interpretation for the earlier hypothesis that hyper-octonionic primes appearing in the infinite prime characterize partonic 2-surfaces geometrically. One can also identify the fermionic and purely bosonic primes appearing in the infinite prime as braid strands carrying fermion number and purely bosonic quantum numbers. This option will be assumed in the following.

# Mathematics

- [A1] Gaussian Mersenne. <http://primes.utm.edu/glossary/xpage/GaussianMersenne.html>.
- [A2] Z. I. Borevich and I. R. Shafarevich. *Number Theory*. Academic Press, 1966.
- [A3] Eisenhart. *Riemannian Geometry*. Princeton University Press, 1964.
- [A4] C. N. Pope G. W. Gibbons.  $CP_2$  as gravitational instanton. *Comm. Math. Phys.*, 55, 1977.
- [A5] W. Hawking, S. and N. Pope, C. Generalized Spin Structures in Quantum Gravity. *Phys. Lett.*, (1), 1978.
- [A6] S. Helgason. *Differential Geometry and Symmetric Spaces*. Academic Press, New York, 1962.
- [A7] C. Itzykson and J-B. Zuber. *Quantum Field Theory*, volume 549. Mc Graw-Hill, New York, 1980.
- [A8] J. Milnor. *Topology form Differential Point of View*. The University Press of Virginia, Virginia, 1965.
- [A9] D. S. Moak. The q-analogue of the Laguerre polynomials. *J. Math. Anal. Appl.*, 81, 1981.
- [A10] N. Pope, C. Eigenfunctions and  $Spin^c$  Structures on  $CP_2$ , 1980.
- [A11] B. Shipman. The geometry of momentum mappings on generalized flag manifolds, connections with a dynamical system, quantum mechanics and the dance of honeybee. <http://math.cornell.edu/~oliver/Shipman.gif>, 1998.
- [A12] M. Spivak. *Differential Geometry I,II,III,IV*. Publish or Perish, Boston, 1970.
- [A13] J. Hanson T. Eguchi, B. Gilkey. *Phys. Rep.*, 66:1980, 1980.
- [A14] R. Thom. *Commentarii Math. Helvet.*, 28, 1954.
- [A15] Wallace. *Differential Topology*. W. A. Benjamin, New York, 1968.
- [A16] E. C. Zeeman. *Catastrophe Theory*. Addison-Wessley Publishing Company, 1977.



# Theoretical Physics

- [B1] J. Björken and S. Drell. *Relativistic Quantum Fields*. Mc Graw-Hill, New York, 1965.
- [B2] K. Huang. *Quarks, Leptons & Gauge Fields*. World Scientific, 1982.
- [B3] R. Kiehn. Electromagnetic waves in vacuum with torsion and spin. <http://www22.pair.com/csdc/pdf/helical6.pdf>.
- [B4] G. Parisi. *Field Theory, Disorder and Simulations*. World Scientific, 1992.
- [B5] A. Zee. *The Unity of Forces in the Universe*. World Science Press, Singapore, 1982.



# Cosmology and Astro-Physics

- [E1] Age of the universe. [http://en.wikipedia.org/wiki/Age\\_of\\_the\\_universe](http://en.wikipedia.org/wiki/Age_of_the_universe).
- [E2] Allais effect. [http://en.wikipedia.org/wiki/Allais\\_effect](http://en.wikipedia.org/wiki/Allais_effect).
- [E3] Cavendish experiment. [http://en.wikipedia.org/wiki/Cavendish\\_experiment](http://en.wikipedia.org/wiki/Cavendish_experiment).
- [E4] French Nobel Laureate turns back clock. [http://science.nasa.gov/newhome/headlines/ast12oct99\\_1.htm](http://science.nasa.gov/newhome/headlines/ast12oct99_1.htm).
- [E5] French Nobel Laureate turns back clock: Marshall's global experiment, von Braun memories evoked during August 11 solar eclipse. [http://science.nasa.gov/newhome/headlines/ast12oct99\\_1.htm](http://science.nasa.gov/newhome/headlines/ast12oct99_1.htm).
- [E6] Rings of Saturn. [http://en.wikipedia.org/wiki/Rings\\_of\\_Saturn](http://en.wikipedia.org/wiki/Rings_of_Saturn).
- [E7] Saturn. <http://en.wikipedia.org/wiki/Saturn>.
- [E8] Saturnus. <http://en.wikipedia.org/wiki/Saturn>.
- [E9] M. Allais. Should the Laws of Gravitation be modified?: Part I -Abnormalities in the Motion of a Paraconical Pendulum with Anisotropic Support. *Aero/Space Engineering*, 1959, 1959.
- [E10] M. Allais. Should the Laws of Gravitation be modified?: Part II -Experiments in Connection with the Abnormalities the Motion of a Paraconical Pendulum with an Isotropic Support. *Aero/Space Engineering*, October 1959.
- [E11] M. Allais. Should the Laws of Gravitation Be Reconsidered: Part I,II,III? <http://home.t01.itscom.net/allais/blackprior/allais/lawgravit/lawgrav-one.pdf>, 1959.
- [E12] C. Charbonnel and F. Primas. The lithium content of the Galactic Halo stars. <http://arxiv.org/abs/astro-ph/0505247>, 2005.
- [E13] A. E. Nelson E. G. Adelberger, B. R. Heckel. Tests of Gravitational Inverse-Square Law. <http://www.npl.washington.edu/eotwash/pdf/review.pdf>, 2005.
- [E14] J. A. Eddy and A. A. Boornazian. Secular decrease in the solar diameter. *Bulletin of the American Astronomical Society*, 11(437):1863–1953, 1979.
- [E15] I. Mihaila et al. A new confirmation of the Allais effect during the solar eclipse of 31 2003 May. <http://home.t01.itscom.net/allais/blackprior/mihaila/2003/mihaila2003.pdf>, 2003.
- [E16] Qian-Shen Wang et al. Precise measurement of gravity variations during a total solar eclipse. *Phys. Rev. D*. <http://home.t01.itscom.net/allais/blackprior/wang/wangetal.pdf>, 62, 2000.
- [E17] S. E. Shnoll et al. Realization of discrete fluctuations in macroscopic processes. *Physics-Uspekhi*. <http://home.t01.itscom.net/allais/blackprior/shnoll/shnoll-1.pdf>, 41(10):1025–1035, 1998.
- [E18] G. I. Rusu G. T. Jeverdan and V. Antonescu. Experiments using the Foucault pendulum during the solar eclipse of 15 February, 1961. *Biblical Astronomer*, 1(55), 1981.

- [E19] G. T. Gilles. *American J. of Physics*, 58, 1990.
- [E20] R. L. Gilliland. Solar radius variations over the past 265 years. *Astrophysical Journal*, 248:1155, 1981.
- [E21] Gia Dvali Nima Arkani-Hamed, Savas Dimopoulos. The Hierarchy Problem and New Dimensions at a Millimeter. <http://arxiv.org/abs/hep-ph/9803315>, 1998.
- [E22] M. Holman R. Malhotra and T. Ito. Chaos and stability of the solar system. *Proc. Natl. Acad. Sci. USA*. <http://www.pubmedcentral.nih.gov/articlerender.fcgi?artid=60054>, 98:12342–12343, October 2001.
- [E23] D. Da Roacha and L. Nottale. Gravitational Structure Formation in Scale Relativity. <http://arxiv.org/abs/astro-ph/0310036>, 2003.
- [E24] R. N. Tran U. E. Kruse. Cavendish experiment. <http://www.ccsr.uiuc.edu/~alfred/Ph101/Notes.htm/cavendish/index.html>, 1995.
- [E25] D. Olenici V. A. Popescu. A confirmation of the Allais and Jeverdan-Rusu-Antonescu effects during the solar eclipse from 22 September 2006, and the quantization behavior of pendulum. <http://www.hessdalen.org/sse/program/Articol.pdf>, 2007.



# Books related to TGD

- [K1] M. Pitkänen. 1983.
- [K2] M. Pitkänen. Is it Possible to Understand Coupling Constant Evolution at Space-Time Level? In *Towards M-Matrix*. Onlinebook. [http://tgdtheory.com/public\\_html/tgdquant/tgdquant.html#rgflow](http://tgdtheory.com/public_html/tgdquant/tgdquant.html#rgflow), 2006.
- [K3] M. Pitkänen. About Strange Effects Related to Rotating Magnetic Systems . In *TGD and Fringe Physics*. Onlinebook. [http://tgdtheory.com/public\\_html/freenergy/freenergy.html#Faraday](http://tgdtheory.com/public_html/freenergy/freenergy.html#Faraday), 2006.
- [K4] M. Pitkänen. About the New Physics Behind Qualia. In *Quantum Hardware of Living Matter*. Onlinebook. [http://tgdtheory.com/public\\_html/bioware/bioware.html#newphys](http://tgdtheory.com/public_html/bioware/bioware.html#newphys), 2006.
- [K5] M. Pitkänen. An Overview about Quantum TGD: Part I. In *Topological Geometrodynamics: Overview*. Onlinebook. [http://tgdtheory.com/public\\_html/tgdview/tgdview.html#evoII](http://tgdtheory.com/public_html/tgdview/tgdview.html#evoII), 2006.
- [K6] M. Pitkänen. An Overview about the Evolution of Quantum TGD. In *Topological Geometrodynamics: Overview*. Onlinebook. [http://tgdtheory.com/public\\_html/tgdview/tgdview.html#evoI](http://tgdtheory.com/public_html/tgdview/tgdview.html#evoI), 2006.
- [K7] M. Pitkänen. Anomalies Related to the Classical  $Z^0$  Force and Gravitation. In *TGD and Fringe Physics*. Onlinebook. [http://tgdtheory.com/public\\_html/freenergy/freenergy.html#Zanom](http://tgdtheory.com/public_html/freenergy/freenergy.html#Zanom), 2006.
- [K8] M. Pitkänen. Appendix A: Quantum Groups and Related Structures. In *Towards M-Matrix*. Onlinebook. [http://tgdtheory.com/public\\_html/tgdquant/tgdquant.html#bialgebra](http://tgdtheory.com/public_html/tgdquant/tgdquant.html#bialgebra), 2006.
- [K9] M. Pitkänen. Basic Extremals of Kähler Action. In *Physics in Many-Sheeted Space-Time*. Onlinebook. [http://tgdtheory.com/public\\_html/tgdclass/tgdclass.html#class](http://tgdtheory.com/public_html/tgdclass/tgdclass.html#class), 2006.
- [K10] M. Pitkänen. *Bio-Systems as Conscious Holograms*. Onlinebook. [http://tgdtheory.com/public\\_html/hologram/hologram.html](http://tgdtheory.com/public_html/hologram/hologram.html), 2006.
- [K11] M. Pitkänen. Bio-Systems as Conscious Holograms. In *Bio-Systems as Conscious Holograms*. Onlinebook. [http://tgdtheory.com/public\\_html/hologram/hologram.html#hologram](http://tgdtheory.com/public_html/hologram/hologram.html#hologram), 2006.
- [K12] M. Pitkänen. *Bio-Systems as Self-Organizing Quantum Systems*. Onlinebook. [http://tgdtheory.com/public\\_html/bioselforg/bioselforg.html](http://tgdtheory.com/public_html/bioselforg/bioselforg.html), 2006.
- [K13] M. Pitkänen. Bio-Systems as Super-Conductors: part I. In *Quantum Hardware of Living Matter*. Onlinebook. [http://tgdtheory.com/public\\_html/bioware/bioware.html#superc1](http://tgdtheory.com/public_html/bioware/bioware.html#superc1), 2006.
- [K14] M. Pitkänen. Bio-Systems as Super-Conductors: part II. In *Quantum Hardware of Living Matter*. Onlinebook. [http://tgdtheory.com/public\\_html/bioware/bioware.html#superc2](http://tgdtheory.com/public_html/bioware/bioware.html#superc2), 2006.
- [K15] M. Pitkänen. Configuration Space Spinor Structure. In *Quantum Physics as Infinite-Dimensional Geometry*. Onlinebook. [http://tgdtheory.com/public\\_html/tgdgeom/tgdgeom.html#cspin](http://tgdtheory.com/public_html/tgdgeom/tgdgeom.html#cspin), 2006.

- [K16] M. Pitkänen. Construction of elementary particle vacuum functionals. In *p-Adic Length Scale Hypothesis and Dark Matter Hierarchy*. Onlinebook. [http://tgdtheory.com/public\\_html/paddark/paddark.html#elvafu](http://tgdtheory.com/public_html/paddark/paddark.html#elvafu), 2006.
- [K17] M. Pitkänen. Construction of Quantum Theory: M-matrix. In *Towards M-Matrix*. Onlinebook. [http://tgdtheory.com/public\\_html/tgdquant/tgdquant.html#towards](http://tgdtheory.com/public_html/tgdquant/tgdquant.html#towards), 2006.
- [K18] M. Pitkänen. Cosmic Strings. In *Physics in Many-Sheeted Space-Time*. Onlinebook. [http://tgdtheory.com/public\\_html/tgdclass/tgdclass.html#cstrings](http://tgdtheory.com/public_html/tgdclass/tgdclass.html#cstrings), 2006.
- [K19] M. Pitkänen. Crop Circles and Life at Parallel Space-Time Sheets. In *Magnetospheric Consciousness*. Onlinebook. [http://tgdtheory.com/public\\_html/magnconsc/magnconsc.html#crop1](http://tgdtheory.com/public_html/magnconsc/magnconsc.html#crop1), 2006.
- [K20] M. Pitkänen. Crop Circles and Life at Parallel Space-Time Sheets. In *Magnetospheric Consciousness*. Onlinebook. [http://tgdtheory.com/public\\_html/magnconsc/magnconsc.html#crop2](http://tgdtheory.com/public_html/magnconsc/magnconsc.html#crop2), 2006.
- [K21] M. Pitkänen. Dark Forces and Living Matter. In *p-Adic Length Scale Hypothesis and Dark Matter Hierarchy*. Onlinebook. [http://tgdtheory.com/public\\_html/paddark/paddark.html#darkforces](http://tgdtheory.com/public_html/paddark/paddark.html#darkforces), 2006.
- [K22] M. Pitkänen. Dark Matter Hierarchy and Hierarchy of EEGs. In *TGD and EEG*. Onlinebook. [http://tgdtheory.com/public\\_html/tgdeeg/tgdeeg.html#eegdark](http://tgdtheory.com/public_html/tgdeeg/tgdeeg.html#eegdark), 2006.
- [K23] M. Pitkänen. Dark Nuclear Physics and Condensed Matter. In *p-Adic Length Scale Hypothesis and Dark Matter Hierarchy*. Onlinebook. [http://tgdtheory.com/public\\_html/paddark/paddark.html#exonuclear](http://tgdtheory.com/public_html/paddark/paddark.html#exonuclear), 2006.
- [K24] M. Pitkänen. DNA as Topological Quantum Computer. In *Genes and Memes*. Onlinebook. [http://tgdtheory.com/public\\_html/genememe/genememe.html#dnatqc](http://tgdtheory.com/public_html/genememe/genememe.html#dnatqc), 2006.
- [K25] M. Pitkänen. Does TGD Predict the Spectrum of Planck Constants? In *Towards M-Matrix*. Onlinebook. [http://tgdtheory.com/public\\_html/tgdquant/tgdquant.html#Planck](http://tgdtheory.com/public_html/tgdquant/tgdquant.html#Planck), 2006.
- [K26] M. Pitkänen. Evolution in Many-Sheeted Space-Time. In *Genes and Memes*. Onlinebook. [http://tgdtheory.com/public\\_html/genememe/genememe.html#prebio](http://tgdtheory.com/public_html/genememe/genememe.html#prebio), 2006.
- [K27] M. Pitkänen. General Ideas about Many-Sheeted Space-Time: Part I. In *Physics in Many-Sheeted Space-Time*. Onlinebook. [http://tgdtheory.com/public\\_html/tgdclass/tgdclass.html#topcond](http://tgdtheory.com/public_html/tgdclass/tgdclass.html#topcond), 2006.
- [K28] M. Pitkänen. General Theory of Qualia. In *Bio-Systems as Conscious Holograms*. Onlinebook. [http://tgdtheory.com/public\\_html/hologram/hologram.html#qualia](http://tgdtheory.com/public_html/hologram/hologram.html#qualia), 2006.
- [K29] M. Pitkänen. *Genes and Memes*. Onlinebook. [http://tgdtheory.com/public\\_html/genememe/genememe.html](http://tgdtheory.com/public_html/genememe/genememe.html), 2006.
- [K30] M. Pitkänen. Genes and Memes. In *Genes and Memes*. Onlinebook. [http://tgdtheory.com/public\\_html/genememe/genememe.html#genememec](http://tgdtheory.com/public_html/genememe/genememe.html#genememec), 2006.
- [K31] M. Pitkänen. Homeopathy in Many-Sheeted Space-Time. In *Bio-Systems as Conscious Holograms*. Onlinebook. [http://tgdtheory.com/public\\_html/hologram/hologram.html#homeoc](http://tgdtheory.com/public_html/hologram/hologram.html#homeoc), 2006.
- [K32] M. Pitkänen. Macro-Temporal Quantum Coherence and Spin Glass Degeneracy. In *Bio-Systems as Conscious Holograms*. Onlinebook. [http://tgdtheory.com/public\\_html/hologram/hologram.html#macro](http://tgdtheory.com/public_html/hologram/hologram.html#macro), 2006.
- [K33] M. Pitkänen. Macroscopic Quantum Coherence and Quantum Metabolism as Different Sides of the Same Coin. In *Bio-Systems as Conscious Holograms*. Onlinebook. [http://tgdtheory.com/public\\_html/hologram/hologram.html#metab](http://tgdtheory.com/public_html/hologram/hologram.html#metab), 2006.

- [K34] M. Pitkänen. Macroscopic Quantum Phenomena and  $CP_2$  Geometry. In *Physics in Many-Sheeted Space-Time*. Onlinebook. [http://tgdtheory.com/public\\_html/tgdclass/tgdclass.html#super](http://tgdtheory.com/public_html/tgdclass/tgdclass.html#super), 2006.
- [K35] M. Pitkänen. Magnetic Sensory Canvas Hypothesis. In *TGD and EEG*. Onlinebook. [http://tgdtheory.com/public\\_html//tgdeeg/tgdeeg/tgdeeg.html#mec](http://tgdtheory.com/public_html//tgdeeg/tgdeeg/tgdeeg.html#mec), 2006.
- [K36] M. Pitkänen. *Magnetospheric Consciousness*. Onlinebook. [http://tgdtheory.com/public\\_html/magnconsc/magnconsc.html](http://tgdtheory.com/public_html/magnconsc/magnconsc.html), 2006.
- [K37] M. Pitkänen. Magnetospheric Sensory Representations. In *Magnetospheric Consciousness*. Onlinebook. [http://tgdtheory.com/public\\_html/magnconsc/magnconsc.html#srepress](http://tgdtheory.com/public_html/magnconsc/magnconsc.html#srepress), 2006.
- [K38] M. Pitkänen. Many-Sheeted DNA. In *Genes and Memes*. Onlinebook. [http://tgdtheory.com/public\\_html/genememe/genememe.html#genecodec](http://tgdtheory.com/public_html/genememe/genememe.html#genecodec), 2006.
- [K39] M. Pitkänen. Massless states and particle massivation. In *p-Adic Length Scale Hypothesis and Dark Matter Hierarchy*. Onlinebook. [http://tgdtheory.com/public\\_html/paddark/paddark.html#mless](http://tgdtheory.com/public_html/paddark/paddark.html#mless), 2006.
- [K40] M. Pitkänen. *Mathematical Aspects of Consciousness Theory*. Onlinebook. [http://tgdtheory.com/public\\_html/mathconsc/mathconsc.html](http://tgdtheory.com/public_html/mathconsc/mathconsc.html), 2006.
- [K41] M. Pitkänen. Matter, Mind, Quantum. In *TGD Inspired Theory of Consciousness*. Onlinebook. [http://tgdtheory.com/public\\_html/tgdconsc/tgdconsc.html#conscic](http://tgdtheory.com/public_html/tgdconsc/tgdconsc.html#conscic), 2006.
- [K42] M. Pitkänen. Negentropy Maximization Principle. In *TGD Inspired Theory of Consciousness*. Onlinebook. [http://tgdtheory.com/public\\_html/tgdconsc/tgdconsc.html#nmpc](http://tgdtheory.com/public_html/tgdconsc/tgdconsc.html#nmpc), 2006.
- [K43] M. Pitkänen. New Particle Physics Predicted by TGD: Part I. In *p-Adic Length Scale Hypothesis and Dark Matter Hierarchy*. Onlinebook. [http://tgdtheory.com/public\\_html/paddark/paddark.html#mass4](http://tgdtheory.com/public_html/paddark/paddark.html#mass4), 2006.
- [K44] M. Pitkänen. Nuclear String Hypothesis. In *p-Adic Length Scale Hypothesis and Dark Matter Hierarchy*. Onlinebook. [http://tgdtheory.com/public\\_html/paddark/paddark.html#nuclstring](http://tgdtheory.com/public_html/paddark/paddark.html#nuclstring), 2006.
- [K45] M. Pitkänen. *p-Adic length Scale Hypothesis and Dark Matter Hierarchy*. Onlinebook. [http://tgdtheory.com/public\\_html/paddark/paddark.html](http://tgdtheory.com/public_html/paddark/paddark.html), 2006.
- [K46] M. Pitkänen. p-Adic Particle Massivation: Hadron Masses. In *p-Adic Length Scale Hypothesis and Dark Matter Hierarchy*. Onlinebook. [http://tgdtheory.com/public\\_html/paddark/paddark.html#mass3](http://tgdtheory.com/public_html/paddark/paddark.html#mass3), 2006.
- [K47] M. Pitkänen. p-Adic Physics as Physics of Cognition and Intention. In *TGD Inspired Theory of Consciousness*. Onlinebook. [http://tgdtheory.com/public\\_html/tgdconsc/tgdconsc.html#cognic](http://tgdtheory.com/public_html/tgdconsc/tgdconsc.html#cognic), 2006.
- [K48] M. Pitkänen. *Physics in Many-Sheeted Space-Time*. Onlinebook. [http://tgdtheory.com/public\\_html/tgdclass/tgdclass.html](http://tgdtheory.com/public_html/tgdclass/tgdclass.html), 2006.
- [K49] M. Pitkänen. Quantum Antenna Hypothesis. In *Quantum Hardware of Living Matter*. Onlinebook. [http://tgdtheory.com/public\\_html/bioware/bioware.html#tubuc](http://tgdtheory.com/public_html/bioware/bioware.html#tubuc), 2006.
- [K50] M. Pitkänen. Quantum Astrophysics. In *Physics in Many-Sheeted Space-Time*. Onlinebook. [http://tgdtheory.com/public\\_html/tgdclass/tgdclass.html#qastro](http://tgdtheory.com/public_html/tgdclass/tgdclass.html#qastro), 2006.
- [K51] M. Pitkänen. Quantum Control and Coordination in Bio-systems: Part I. In *Bio-Systems as Self-Organizing Quantum Systems*. Onlinebook. [http://tgdtheory.com/public\\_html/bioselforg/bioselforg.html#qcococI](http://tgdtheory.com/public_html/bioselforg/bioselforg.html#qcococI), 2006.
- [K52] M. Pitkänen. Quantum Control and Coordination in Bio-Systems: Part II. In *Bio-Systems as Self-Organizing Quantum Systems*. Onlinebook. [http://tgdtheory.com/public\\_html/bioselforg/bioselforg.html#qcococII](http://tgdtheory.com/public_html/bioselforg/bioselforg.html#qcococII), 2006.

- [K53] M. Pitkänen. *Quantum Hardware of Living Matter*. Onlinebook. [http://tgdtheory.com/public\\_html/bioware/bioware.html](http://tgdtheory.com/public_html/bioware/bioware.html), 2006.
- [K54] M. Pitkänen. Quantum Model for Hearing. In *TGD and EEG*. Onlinebook. [http://tgdtheory.com/public\\_html//tgdeeg/tgdeeg/tgdeeg.html#hearing](http://tgdtheory.com/public_html//tgdeeg/tgdeeg/tgdeeg.html#hearing), 2006.
- [K55] M. Pitkänen. Quantum Model for Nerve Pulse. In *TGD and EEG*. Onlinebook. [http://tgdtheory.com/public\\_html//tgdeeg/tgdeeg/tgdeeg.html#pulse](http://tgdtheory.com/public_html//tgdeeg/tgdeeg/tgdeeg.html#pulse), 2006.
- [K56] M. Pitkänen. Quantum Model for Paranormal Phenomena. In *TGD Inspired Theory of Consciousness*. Onlinebook. [http://tgdtheory.com/public\\_html/tgdconsc/tgdconsc.html#parac](http://tgdtheory.com/public_html/tgdconsc/tgdconsc.html#parac), 2006.
- [K57] M. Pitkänen. Quantum Model for Sensory Representations. In *TGD Inspired Theory of Consciousness*. Onlinebook. [http://tgdtheory.com/public\\_html/tgdconsc/tgdconsc.html#expc](http://tgdtheory.com/public_html/tgdconsc/tgdconsc.html#expc), 2006.
- [K58] M. Pitkänen. Quantum Model of EEG. In *TGD and EEG*. Onlinebook. [http://tgdtheory.com/public\\_html/tgdeeg/tgdeeg.html#eegII](http://tgdtheory.com/public_html/tgdeeg/tgdeeg.html#eegII), 2006.
- [K59] M. Pitkänen. Quantum Model of Memory. In *TGD Inspired Theory of Consciousness*. Onlinebook. [http://tgdtheory.com/public\\_html/tgdconsc/tgdconsc.html#memoryc](http://tgdtheory.com/public_html/tgdconsc/tgdconsc.html#memoryc), 2006.
- [K60] M. Pitkänen. *Quantum Physics as Infinite-Dimensional Geometry*. Onlinebook. [http://tgdtheory.com/public\\_html/tgdgeom/tgdgeom.html](http://tgdtheory.com/public_html/tgdgeom/tgdgeom.html), 2006.
- [K61] M. Pitkänen. *Quantum TGD*. Onlinebook. [http://tgdtheory.com/public\\_html/tgdquant/tgdquant.html](http://tgdtheory.com/public_html/tgdquant/tgdquant.html), 2006.
- [K62] M. Pitkänen. Quantum Theory of Self-Organization. In *Bio-Systems as Self-Organizing Quantum Systems*. Onlinebook. [http://tgdtheory.com/public\\_html/bioselforg/bioselforg.html#selforgac](http://tgdtheory.com/public_html/bioselforg/bioselforg.html#selforgac), 2006.
- [K63] M. Pitkänen. Semi-trance, Mental Illness, and Altered States of Consciousness. In *Magnetospheric Consciousness*. Onlinebook. [http://tgdtheory.com/public\\_html/magnconsc/magnconsc.html#semitrancec](http://tgdtheory.com/public_html/magnconsc/magnconsc.html#semitrancec), 2006.
- [K64] M. Pitkänen. Semitrance, Language, and Development of Civilization. In *Magnetospheric Consciousness*. Onlinebook. [http://tgdtheory.com/public\\_html/magnconsc/magnconsc.html#langsoc](http://tgdtheory.com/public_html/magnconsc/magnconsc.html#langsoc), 2006.
- [K65] M. Pitkänen. TGD and Astrophysics. In *Physics in Many-Sheeted Space-Time*. Onlinebook. [http://tgdtheory.com/public\\_html/tgdclass/tgdclass.html#astro](http://tgdtheory.com/public_html/tgdclass/tgdclass.html#astro), 2006.
- [K66] M. Pitkänen. TGD and Cosmology. In *Physics in Many-Sheeted Space-Time*. Onlinebook. [http://tgdtheory.com/public\\_html/tgdclass/tgdclass.html#cosmo](http://tgdtheory.com/public_html/tgdclass/tgdclass.html#cosmo), 2006.
- [K67] M. Pitkänen. *TGD and EEG*. Onlinebook. [http://tgdtheory.com/public\\_html/tgdeeg/tgdeeg.html](http://tgdtheory.com/public_html/tgdeeg/tgdeeg.html), 2006.
- [K68] M. Pitkänen. *TGD and Fringe Physics*. Onlinebook. [http://tgdtheory.com/public\\_html/freenergy/freenergy.html](http://tgdtheory.com/public_html/freenergy/freenergy.html), 2006.
- [K69] M. Pitkänen. TGD and Nuclear Physics. In *p-Adic Length Scale Hypothesis and Dark Matter Hierarchy*. Onlinebook. [http://tgdtheory.com/public\\_html/paddark/paddark.html#padnucl](http://tgdtheory.com/public_html/paddark/paddark.html#padnucl), 2006.
- [K70] M. Pitkänen. *TGD as a Generalized Number Theory*. Onlinebook. [http://tgdtheory.com/public\\_html/tgdnumber/tgdnumber.html](http://tgdtheory.com/public_html/tgdnumber/tgdnumber.html), 2006.
- [K71] M. Pitkänen. TGD as a Generalized Number Theory: p-Adicization Program. In *TGD as a Generalized Number Theory*. Onlinebook. [http://tgdtheory.com/public\\_html/tgdnumber/tgdnumber.html#visiona](http://tgdtheory.com/public_html/tgdnumber/tgdnumber.html#visiona), 2006.

- [K72] M. Pitkänen. TGD as a Generalized Number Theory: Quaternions, Octonions, and their Hyper Counterparts. In *TGD as a Generalized Number Theory*. Onlinebook. [http://tgdtheory.com/public\\_html/tgdnumber/tgdnumber.html#visionb](http://tgdtheory.com/public_html/tgdnumber/tgdnumber.html#visionb), 2006.
- [K73] M. Pitkänen. TGD Based Model for OBEs. In *TGD Inspired Theory of Consciousness*. Onlinebook. [http://tgdtheory.com/public\\_html/tgdconsc/tgdconsc.html#OBE](http://tgdtheory.com/public_html/tgdconsc/tgdconsc.html#OBE), 2006.
- [K74] M. Pitkänen. *TGD Inspired Theory of Consciousness*. Onlinebook. [http://tgdtheory.com/public\\_html/tgdconsc/tgdconsc.html](http://tgdtheory.com/public_html/tgdconsc/tgdconsc.html), 2006.
- [K75] M. Pitkänen. TGD Inspired Theory of Consciousness. In *Topological Geometrodynamics: Overview*. Onlinebook. [http://tgdtheory.com/public\\_html/tgdview/tgdview.html#tgdconsc2010](http://tgdtheory.com/public_html/tgdview/tgdview.html#tgdconsc2010), 2006.
- [K76] M. Pitkänen. The Notion of Free Energy and Many-Sheeted Space-Time Concept. In *TGD and Fringe Physics*. Onlinebook. [http://tgdtheory.com/public\\_html/freenergy/freenergy.html#freenergy](http://tgdtheory.com/public_html/freenergy/freenergy.html#freenergy), 2006.
- [K77] M. Pitkänen. The Relationship Between TGD and GRT. In *Physics in Many-Sheeted Space-Time*. Onlinebook. [http://tgdtheory.com/public\\_html/tgdclass/tgdclass.html#tgdgrt](http://tgdtheory.com/public_html/tgdclass/tgdclass.html#tgdgrt), 2006.
- [K78] M. Pitkänen. Three new physics realizations of the genetic code and the role of dark matter in bio-systems. In *Genes and Memes*. Onlinebook. [http://tgdtheory.com/public\\_html/genememe/genememe.html#dnatqccodes](http://tgdtheory.com/public_html/genememe/genememe.html#dnatqccodes), 2006.
- [K79] M. Pitkänen. Time, Spacetime and Consciousness. In *Bio-Systems as Conscious Holograms*. Onlinebook. [http://tgdtheory.com/public\\_html/hologram/hologram.html#time](http://tgdtheory.com/public_html/hologram/hologram.html#time), 2006.
- [K80] M. Pitkänen. *Topological Geometrodynamics: an Overview*. Onlinebook. [http://tgdtheory.com/public\\_html/tgdview/tgdview.html](http://tgdtheory.com/public_html/tgdview/tgdview.html), 2006.
- [K81] M. Pitkänen. Topological Quantum Computation in TGD Universe. In *Genes and Memes*. Onlinebook. [http://tgdtheory.com/public\\_html/genememe/genememe.html#tqc](http://tgdtheory.com/public_html/genememe/genememe.html#tqc), 2006.
- [K82] M. Pitkänen. Was von Neumann Right After All. In *Towards M-Matrix*. Onlinebook. [http://tgdtheory.com/public\\_html/tgdquant/tgdquant.html#vNeumann](http://tgdtheory.com/public_html/tgdquant/tgdquant.html#vNeumann), 2006.
- [K83] M. Pitkänen. Wormhole Magnetic Fields. In *Quantum Hardware of Living Matter*. Onlinebook. [http://tgdtheory.com/public\\_html/bioware/bioware.html#wormc](http://tgdtheory.com/public_html/bioware/bioware.html#wormc), 2006.



# Articles about TGD

- [L1] M. Pitkänen. Macro-temporal quantum coherence, quantum spin glass degeneracy, and number theoretic information concept. <http://www.emergentmind.org/journal.htm>, 2003.
- [L2] M. Pitkänen. Time, Space-Time, and Consciousness. <http://www.emergentmind.org/journal.htm>, 2003.
- [L3] M. Pitkänen. Further Progress in Nuclear String Hypothesis. <http://tgdtheory.com/articles/nuclstring.pdf>, 2007.
- [L4] M. Pitkänen. TGD based solution of Fermi paradox. <http://www.physics.helsinki.fi/~matpitka/articles/fermieng.pdf>, 2007.





## Chapter 9

# Yangian Symmetry, Twistors, and TGD

### 9.1 Introduction

Lubos [?] told for some time ago about last impressive steps in the understanding of  $\mathcal{N} = 4$  maximally supersymmetric YM theory (SYM) possessing 4-D super-conformal symmetry. This theory is related by AdS/CFT duality to certain string theory in  $AdS_5 \times S^5$  background. Second stringy representation was discovered by Witten and based on 6-D Calabi-Yau manifold defined by twistors. In the following I will discuss briefly the notion of Yangian symmetry and suggest its generalization in TGD framework by replacing conformal algebra with appropriate super-conformal algebras. Also a possible realization of twistor approach and the construction of scattering amplitudes in terms of Yangian invariants defined by Grassmannian integrals is considered in TGD framework and based on the idea that in zero energy ontology one can represent massive states as bound states of massless particles. There is also a proposal for a physical interpretation of the Cartan algebra of Yangian algebra allowing to understand at the fundamental level how the mass spectrum of n-particle bound states could be understood in terms of the n-local charges of the Yangian algebra. The study of modified Dirac equation leads to a detailed proposal for the generators of Yangian algebras [?]: the proposal is discussed also in this chapter.

Twistors were originally introduced by Penrose to characterize the solutions of Maxwell's equations. Kähler action is Maxwell action for the induced Kähler form of  $CP_2$ . The preferred extremals allow a very concrete interpretation in terms of modes of massless non-linear field. Both conformally compactified Minkowski space identifiable as so called causal diamond and  $CP_2$  allow a description in terms of twistors. These observations inspire the proposal that a generalization of Witten's twistor string theory relying on the identification of twistor string world sheets with certain holomorphic surfaces assigned with Feynman diagrams could allow a formulation of quantum TGD in terms of 3-dimensional holomorphic surfaces of  $CP_3 \times CP_3$  mapped to 6-surfaces dual  $CP_3 \times CP_3$ , which are sphere bundles so that they are projected in a natural manner to 4-D space-time surfaces. Very general physical and mathematical arguments lead to a highly unique proposal for the holomorphic differential equations defining the complex 3-surfaces conjectured to correspond to the preferred extremals of Kähler action.

#### 9.1.1 Background

I am outsider as far as concrete calculations in  $\mathcal{N} = 4$  SUSY are considered and the following discussion of the background probably makes this obvious. My hope is that the reader had patience to not care about this and try to see the big pattern.

The developments began from the observation of Parke and Taylor [?] that n-gluon tree amplitudes with less than two negative helicities vanish and those with two negative helicities have unexpectedly simple form when expressed in terms of spinor variables used to represent light-like momentum. In fact, in the formalism based on Grassmannian integrals the reduced tree amplitude for two negative helicities is just "1" and defines Yangian invariant. The article *Perturbative Gauge Theory As a*

*String Theory In Twistor Space* [?] by Witten led to so called Britto-Cachazo-Feng-Witten (BCFW) recursion relations for tree level amplitudes [?, ?, ?] allowing to construct tree amplitudes using the analogs of Feynman rules in which vertices correspond to maximally helicity violating tree amplitudes (2 negative helicity gluons) and propagator is massless Feynman propagator for boson. The progress inspired the idea that the theory might be completely integrable meaning the existence of infinite-dimensional un-usual symmetry. This symmetry would be so called Yangian symmetry [?] assigned to the super counterpart of the conformal group of 4-D Minkowski space.

Drumond, Henn, and Plefka represent in the article *Yangian symmetry of scattering amplitudes in  $\mathcal{N} = 4$  super Yang-Mills theory* [?] an argument suggesting that the Yangian invariance of the scattering amplitudes ins an intrinsic property of planar  $\mathcal{N} = 4$  super Yang Mills at least at tree level.

The latest step in the progress was taken by Arkani-Hamed, Bourjaily, Cachazo, Carot-Huot, and Trnka and represented in the article *Yangian symmetry of scattering amplitudes in  $\mathcal{N} = 4$  super Yang-Mills theory* [?]. At the same day there was also the article of Rutger Boels entitled *On BCFW shifts of integrands and integrals* [?] in the archive. Arkani-Hamed *et al* argue that a full Yangian symmetry of the theory allows to generalize the BCFW recursion relation for tree amplitudes to all loop orders at planar limit (planar means that Feynman diagram allows imbedding to plane without intersecting lines). On mass shell scattering amplitudes are in question.

### 9.1.2 Yangian symmetry

The notion equivalent to that of Yangian was originally introduced by Faddeev and his group in the study of integrable systems. Yangians are Hopf algebras which can be assigned with Lie algebras as the deformations of their universal enveloping algebras. The elegant but rather cryptic looking definition is in terms of the modification of the relations for generating elements [?]. Besides ordinary product in the enveloping algebra there is co-product  $\Delta$  which maps the elements of the enveloping algebra to its tensor product with itself. One can visualize product and co-product is in terms of particle reactions. Particle annihilation is analogous to annihilation of two particle so single one and co-product is analogous to the decay of particle to two.  $\Delta$  allows to construct higher generators of the algebra.

Lie-algebra can mean here ordinary finite-dimensional simple Lie algebra, Kac-Moody algebra or Virasoro algebra. In the case of SUSY it means conformal algebra of  $M^4$ - or rather its super counterpart. Witten, Nappi and Dolan have described the notion of Yangian for super-conformal algebra in very elegant and and concrete manner in the article *Yangian Symmetry in  $D=4$  superconformal Yang-Mills theory* [?]. Also Yangians for gauge groups are discussed.

In the general case Yangian resembles Kac-Moody algebra with discrete index  $n$  replaced with a continuous one. Discrete index poses conditions on the Lie group and its representation (adjoint representation in the case of  $\mathcal{N} = 4$  SUSY). One of the conditions conditions is that the tensor product  $R \otimes R^*$  for representations involved contains adjoint representation only once. This condition is non-trivial. For  $SU(n)$  these conditions are satisfied for any representation. In the case of  $SU(2)$  the basic branching rule for the tensor product of representations implies that the condition is satisfied for the product of any representations.

Yangian algebra with a discrete basis is in many respects analogous to Kac-Moody algebra. Now however the generators are labelled by non-negative integers labeling the light-like incoming and outgoing momenta of scattering amplitude whereas in in the case of Kac-Moody algebra also negative values are allowed. Note that only the generators with non-negative conformal weight appear in the construction of states of Kac-Moody and Virasoro representations so that the extension to Yangian makes sense.

The generating elements are labelled by the generators of ordinary conformal transformations acting in  $M^4$  and their duals acting in momentum space. These two sets of elements can be labelled by conformal weights  $n = 0$  and  $n = 1$  and and their mutual commutation relations are same as for Kac-Moody algebra. The commutators of  $n = 1$  generators with themselves are however something different for a non-vanishing deformation parameter  $h$ . Serre's relations characterize the difference and involve the deformation parameter  $h$ . Under repeated commutations the generating elements generate infinite-dimensional symmetric algebra, the Yangian. For  $h = 0$  one obtains just one half of the Virasoro algebra or Kac-Moody algebra. The generators with  $n > 0$  are  $n + 1$ -local in the sense that they involve  $n + 1$ -forms of local generators assignable to the ordered set of incoming particles of

the scattering amplitude. This non-locality generalizes the notion of local symmetry and is claimed to be powerful enough to fix the scattering amplitudes completely.

## 9.2 How to generalize Yangian symmetry in TGD framework?

As far as concrete calculations are considered, I have nothing to say. I am just perplexed. It is however possible to keep discussion at general level and still say something interesting (as I hope!). The key question is whether it could be possible to generalize the proposed Yangian symmetry and geometric picture behind it to TGD framework.

1. The first thing to notice is that the Yangian symmetry of  $\mathcal{N} = 4$  SUSY in question is quite too limited since it allows only single representation of the gauge group and requires massless particles. One must allow all representations and massive particles so that the representation of symmetry algebra must involve states with different masses, in principle arbitrary spin and arbitrary internal quantum numbers. The candidates are obvious: Kac-Moody algebras [?] and Virasoro algebras [?] and their super counterparts. Yangians indeed exist for arbitrary super Lie algebras. In TGD framework conformal algebra of Minkowski space reduces to Poincare algebra and its extension to Kac-Moody allows to have also massive states.
2. The formal generalization looks surprisingly straightforward at the formal level. In zero energy ontology one replaces point like particles with partonic two-surfaces appearing at the ends of light-like orbits of wormhole throats located to the future and past light-like boundaries of causal diamond ( $CD \times CP_2$  or briefly  $CD$ ). Here  $CD$  is defined as the intersection of future and past directed light-cones. The polygon with light-like momenta is naturally replaced with a polygon with more general momenta in zero energy ontology and having partonic surfaces as its vertices. Non-point-likeness forces to replace the finite-dimensional super Lie-algebra with infinite-dimensional Kac-Moody algebras and corresponding super-Virasoro algebras assignable to partonic 2-surfaces.
3. This description replaces disjoint holomorphic surfaces in twistor space with partonic 2-surfaces at the boundaries of  $CD \times CP_2$  so that there seems to be a close analogy with Cachazo-Svrcek-Witten picture. These surfaces are connected by either light-like orbits of partonic 2-surface or space-like 3-surfaces at the ends of  $CD$  so that one indeed obtains the analog of polygon.

What does this then mean concretely (if this word can be used in this kind of context)?

1. At least it means that ordinary Super Kac-Moody and Super Virasoro algebras associated with isometries of  $M^4 \times CP_2$  annihilating the scattering amplitudes must be extended to a co-algebras with a non-trivial deformation parameter. Kac-Moody group is thus the product of Poincare and color groups. This algebra acts as deformations of the light-like 3-surfaces representing the light-like orbits of particles which are extremals of Chern-Simon action with the constraint that weak form of electric-magnetic duality holds true. I know so little about the mathematical side that I cannot tell whether the condition that the product of the representations of Super-Kac-Moody and Super-Virasoro algebras contains adjoint representation only once, holds true in this case. In any case, it would allow all representations of finite-dimensional Lie group in vertices whereas  $\mathcal{N} = 4$  SUSY would allow only the adjoint.
2. Besides this ordinary kind of Kac-Moody algebra there is the analog of Super-Kac-Moody algebra associated with the light-cone boundary which is metrically 3-dimensional. The finite-dimensional Lie group is in this case replaced with infinite-dimensional group of symplectomorphisms of  $\delta M_{+/-}^4$  made local with respect to the internal coordinates of the partonic 2-surface. A coset construction is applied to these two Virasoro algebras so that the differences of the corresponding Super-Virasoro generators and Kac-Moody generators annihilate physical states. This implies that the corresponding four-momenta are same: this expresses the equivalence of gravitational and inertial masses. A generalization of the Equivalence Principle is in question. This picture also justifies p-adic thermodynamics applied to either symplectic or isometry Super-Virasoro and giving thermal contribution to the vacuum conformal and thus to mass squared.

3. The construction of TGD leads also to other super-conformal algebras and the natural guess is that the Yangians of all these algebras annihilate the scattering amplitudes.
4. Obviously, already the starting point symmetries look formidable but they still act on single partonic surface only. The discrete Yangian associated with this algebra associated with the closed polygon defined by the incoming momenta and the negatives of the outgoing momenta acts in multi-local manner on scattering amplitudes. It might make sense to speak about polygons defined also by other conserved quantum numbers so that one would have generalized light-like curves in the sense that state are massless in 8-D sense.

### 9.2.1 Is there any hope about description in terms of Grassmannians?

At technical level the successes of the twistor approach rely on the observation that the amplitudes can be expressed in terms of very simple integrals over sub-manifolds of the space consisting of  $k$ -dimensional planes of  $n$ -dimensional space defined by delta function appearing in the integrand. These integrals define super-conformal Yangian invariants appearing in twistorial amplitudes and the belief is that by a proper choice of the surfaces of the twistor space one can construct all invariants. One can construct also the counterparts of loop corrections by starting from tree diagrams and annihilating pair of particles by connecting the lines and quantum entangling the states at the ends in the manner dictated by the integration over loop momentum. These operations can be defined as operations for Grassmannian integrals in general changing the values of  $n$  and  $k$ . This description looks extremely powerful and elegant and -most importantly- involves only the external momenta.

The obvious question is whether one could use similar invariants in TGD framework to construct the momentum dependence of amplitudes.

1. The first thing to notice is that the super algebras in question act on infinite-dimensional representations and basically in the world of classical worlds assigned to the partonic 2-surfaces correlated by the fact that they are associated with the same space-time surface. This does not promise anything very practical. On the other hand, one can hope that everything related to other than  $M^4$  degrees of freedom could be treated like color degrees of freedom in  $\mathcal{N} = 4$  SYM and would boil down to indices labeling the quantum states. The Yangian conditions coming from isometry quantum numbers, color quantum numbers, and electroweak quantum numbers are of course expected to be highly non-trivial and could fix the coefficients of various singlets resulting in the tensor product of incoming and outgoing states.
2. The fact that incoming particles can be also massive seems to exclude the use of the twistor space. The following observation however raises hopes. The Dirac propagator for wormhole throat is massless propagator but for what I call pseudo momentum. It is still unclear how this momentum relates to the actual four-momentum. Could it be actually equal to it? The recent view about pseudo-momentum does not support this view but it is better to keep mind open. In any case this finding suggests that twistorial approach could work in in more or less standard form. What would be needed is a representation for massive incoming particles as bound states of massless partons. In particular, the massive states of super-conformal representations should allow this kind of description.

Could zero energy ontology allow to achieve this dream?

1. As far as divergence cancellation is considered, zero energy ontology suggests a totally new approach producing the basic nice aspects of QFT approach, in particular unitarity and coupling constant evolution. The big idea related to zero energy ontology is that all virtual particle particles correspond to wormhole throats, which are pairs of on mass shell particles. If their momentum directions are different, one obtains time-like continuum of virtual momenta and if the signs of energy are opposite one obtains also space-like virtual momenta. The on mass shell property for virtual partons (massive in general) implies extremely strong constraints on loops and one expect that only very few loops remain and that they are finite since loop integration reduces to integration over much lower-dimensional space than in the QFT approach. There are also excellent hopes about Cutkoski rules.

2. Could zero energy ontology make also possible to construct massive incoming particles from massless ones? Could one construct the representations of the super conformal algebras using only massless states so that at the fundamental level incoming particles would be massless and one could apply twistor formalism and build the momentum dependence of amplitudes using Grassmannian integrals.

One could indeed construct on mass shell massive states from massless states with momenta along the same line but with three-momenta at opposite directions. Mass squared is given by  $M^2 = 4E^2$  in the coordinate frame, where the momenta are opposite and of same magnitude. One could also argue that partonic 2-surfaces carrying quantum numbers of fermions and their superpartners serve as the analogs of point like massless particles and that topologically condensed fermions and gauge bosons plus their superpartners correspond to pairs of wormhole throats. Stringy objects would correspond to pairs of wormhole throats at the same space-time sheet in accordance with the fact that space-time sheet allows a slicing by string worlds sheets with ends at different wormhole throats and defining time like braiding.

The weak form of electric magnetic duality indeed supports this picture. To understand how, one must explain a little bit what the weak form of electric magnetic duality means.

1. Elementary particles correspond to light-like orbits of partonic 2-surfaces identified as 3-D surfaces at which the signature of the induced metric of space-time surface changes from Euclidian to Minkowskian and 4-D metric is therefore degenerate. The analogy with black hole horizon is obvious but only partial. Weak form of electric-magnetic duality states that the Kähler electric field at the wormhole throat and also at space-like 3-surfaces defining the ends of the space-time surface at the upper and lower light-like boundaries of the causal diamond is proportional to Kähler magnetic field so that Kähler electric flux is proportional Kähler magnetic flux. This implies classical quantization of Kähler electric charge and fixes the value of the proportionality constant.
2. There are also much more profound implications. The vision about TGD as almost topological QFT suggests that Kähler function defining the Kähler geometry of the "world of classical worlds" (WCW) and identified as Kähler action for its preferred extremal reduces to the 3-D Chern-Simons action evaluated at wormhole throats and possible boundary components. Chern-Simons action would be subject to constraints. Wormhole throats and space-like 3-surfaces would represent extremals of Chern-Simons action restricted by the constraint force stating electric-magnetic duality (and realized in terms of Lagrange multipliers as usual).

If one assumes that Kähler current and other conserved currents are proportional to current defining Beltrami flow whose flow lines by definition define coordinate curves of a globally defined coordinate, the Coulombic term of Kähler action vanishes and it reduces to Chern-Simons action if the weak form of electric-magnetic duality holds true. One obtains almost topological QFT. The absolutely essential attribute "almost" comes from the fact that Chern-Simons action is subject to constraints. As a consequence, one obtains non-vanishing four-momenta and WCW geometry is non-trivial in  $M^4$  degrees of freedom. Otherwise one would have only topological QFT not terribly interesting physically.

Consider now the question how one could understand stringy objects as bound states of massless particles.

1. The observed elementary particles are not Kähler monopoles and there much exist a mechanism neutralizing the monopole charge. The only possibility seems to be that there is opposite Kähler magnetic charge at second wormhole throat. The assumption is that in the case of color neutral particles this throat is at a distance of order intermediate gauge boson Compton length. This throat would carry weak isospin neutralizing that of the fermion and only electromagnetic charge would be visible at longer length scales. One could speak of electro-weak confinement. Also color confinement could be realized in analogous manner by requiring the cancellation of monopole charge for many-parton states only. What comes out are string like objects defined by Kähler magnetic fluxes and having magnetic monopoles at ends. Also more general objects with three strings branching from the vertex appear in the case of baryons. The natural guess

is that the partons at the ends of strings and more general objects are massless for incoming particles but that the 3-momenta are in opposite directions so that stringy mass spectrum and representations of relevant super-conformal algebras are obtained. This description brings in mind the description of hadrons in terms of partons moving in parallel apart from transversal momentum about which only momentum squared is taken as observable.

2. Quite generally, one expects for the preferred extremals of Kähler action the slicing of space-time surface with string world sheets with stringy curves connecting wormhole throats. The ends of the stringy curves can be identified as light-like braid strands. Note that the strings themselves define a space-like braiding and the two braidings are in some sense dual. This has a concrete application in TGD inspired quantum biology, where time-like braiding defines topological quantum computer programs and the space-like braidings induced by it its storage into memory. Stringlike objects defining representations of super-conformal algebras must correspond to states involving at least two wormhole throats. Magnetic flux tubes connecting the ends of magnetically charged throats provide a particular realization of stringy on mass shell states. This would give rise to massless propagation at the parton level. The stringy quantization condition for mass squared would read as  $4E^2 = n$  in suitable units for the representations of super-conformal algebra associated with the isometries. For pairs of throats of the same wormhole contact stringy spectrum does not seem plausible since the wormhole contact is in the direction of  $CP_2$ . One can however expect generation of small mass as deviation of vacuum conformal weight from half integer in the case of gauge bosons.

If this picture is correct, one might be able to determine the momentum dependence of the scattering amplitudes by replacing free fermions with pairs of monopoles at the ends of string and topologically condensed fermions gauge bosons with pairs of this kind of objects with wormhole throat replaced by a pair of wormhole throats. This would mean suitable number of doublings of the Grassmannian integrations with additional constraints on the incoming momenta posed by the mass shell conditions for massive states.

### 9.2.2 Could zero energy ontology make possible full Yangian symmetry?

The partons in the loops are on mass shell particles have a discrete mass spectrum but both signs of energy are possible for opposite wormhole throats. This implies that in the rules for constructing loop amplitudes from tree amplitudes, propagator entanglement is restricted to that corresponding to pairs of partonic on mass shell states with both signs of energy. As emphasized in [?], it is the Grassmannian integrands and leading order singularities of  $\mathcal{N} = 4$  SYM, which possess the full Yangian symmetry. The full integral over the loop momenta breaks the Yangian symmetry and brings in IR singularities. Zero energy ontologist finds it natural to ask whether QFT approach shows its inadequacy both via the UV divergences and via the loss of full Yangian symmetry. The restriction of virtual partons to discrete mass shells with positive or negative sign of energy imposes extremely powerful restrictions on loop integrals and resembles the restriction to leading order singularities. Could this restriction guarantee full Yangian symmetry and remove also IR singularities?

### 9.2.3 Could Yangian symmetry provide a new view about conserved quantum numbers?

The Yangian algebra has some properties which suggest a new kind of description for bound states. The Cartan algebra generators of  $n = 0$  and  $n = 1$  levels of Yangian algebra commute. Since the co-product  $\Delta$  maps  $n = 0$  generators to  $n = 1$  generators and these in turn to generators with high value of  $n$ , it seems that they commute also with  $n \geq 1$  generators. This applies to four-momentum, color isospin and color hyper charge, and also to the Virasoro generator  $L_0$  acting on Kac-Moody algebra of isometries and defining mass squared operator.

Could one identify total four momentum and Cartan algebra quantum numbers as sum of contributions from various levels? If so, the four momentum and mass squared would involve besides the local term assignable to wormhole throats also n-local contributions. The interpretation in terms of n-parton bound states would be extremely attractive. n-local contribution would involve interaction energy. For instance, string like object would correspond to  $n = 1$  level and give  $n = 2$ -local contribution to the momentum. For baryonic valence quarks one would have 3-local contribution corresponding

to  $n = 2$  level. The Yangian view about quantum numbers could give a rigorous formulation for the idea that massive particles are bound states of massless particles.

### 9.2.4 What about the selection of preferred $M^2 \subset M^4$ ?

The puzzling aspect of the proposed picture is the restriction of the pseudo-momenta to  $M^2$  and quite generally the the selection of preferred plane  $M^2 \subset M^4$ . This selection is one the key aspects of TGD but is not too well understood. Also the closely related physical interpretation of the 2-D pseudo-momenta in  $M^2$  is unclear.

#### The avatars of $M^2 \subset M^4$ in quantum TGD

The choice of preferred plane  $M^2 \subset M^4$  pops u again and again in quantum TGD.

1. There are very strong reasons to believe that the solutions of field equations for the preferred extremals assign  $M^2$  to each point of space-time surface and the interpretation is as the plane of non-physical polarizations. One can also consider the possibility that  $M^2$  depends on the point of space-time surface but that the different choices integrate to 2-D surface analogous to string world sheet - very naturally projection of stringy worlds sheets defining the slicing of the space-time surface.
2. The number theoretic vision- in particular  $M^8 - H$  duality ( $H = M^4 \times CP_2$ ) providing a purely number theoretic interpretation for the choice  $H = M^4 \times CP_2$  - involves also the selection of preferred  $M^2$ . The duality states that the surfaces in  $H$  can be regarded equivalently as surfaces in  $M^8$ . The induced metric and Kähler form are identical as also the value of Kähler function. The description of the duality is following.
  - (a) The points of space-time surface in  $M^8 = M^4 \times E^4$  in  $M^8$  are mapped to points of space-time surface in  $M^4 \times CP_2$ . The  $M^4$  part of the map is just a projection.
  - (b)  $CP_2$  part of the map is less trivial. The idea is that  $M^8$  is identified as a subspace of complexified octonions obtained by adding commutative imaginary unit, I call this sub-space hyper-octonionic. Suppose that space-time surface is hyper-quaternionic (in appropriate sense meaning that one can attach to its each point a hyper-quaternionic plane, not necessary tangent plane). Assume that it also contains a preferred hypercomplex plane  $M^2$  of  $M^8$  at each point -or more generally a varying plane  $M^2$  planes whose distribution however integrates to form 2-surface analogous to string world sheet. The interpretation is as a preferred plane of non-physical polarizations so that basic aspect of gauge symmetry would have a number theoretic interpretation. Note that one would thus have a local hierarchy of octonionic, quaternionic, and complex planes.
  - (c) Under these assumptions the tangent plane (if action is just the four-volume or its generalization in the case of Kähler action) is characterized by a point of  $CP_2 = SU(3)/U(2)$  where  $SU(3)$  is automorphism group of octonions respecting preferred plane  $M^2$  of polarizations and  $U(2)$  is automorphism group acting in the hyper-quaternionic plane. This point can be identified as a point of  $CP_2$  so that one obtains the duality.
3. Also the definition of  $CD$ s and the proposed construction of the hierarchy of Planck constants involve a choice of preferred  $M^2$ , which corresponds to the choice of rest frame and quantization axis of angular momentum physically. Therefore the choice of quantization axis would have direct correlates both at the level of  $CD$ s and space-time surface. The vector between the tips of  $CD$  indeed defines preferred direction of time and thus rest system. Similar considerations apply in the case of  $CP_2$ .
4. Preferred  $M^2$  -but now at this time at momentum space level - appears as the plane of pseudo-momenta associated with the generalized eigen modes of the modified Dirac equation associated with Chern-Simons action. Internally consistency requires a restriction to this plane. This looks somewhat mysterious since this would mean that all exchanged virtual momenta would be in  $M^2$  if the choice is same for all lines of the generalized Feynman graph. This would restrict momentum exchanges in particle reactions to single dimension and does not make sense. One

must however notice that in the description of hadronic reactions in QCD picture one makes a choice of longitudinal momentum direction and considers only longitudinal momenta. It would seem that the only possibility is that the planes  $M^2$  are independent for independent exchanged momenta. For instance, in  $2 \rightarrow 2$  scattering the exchange would be in plane defined by the initial and final particles of the vertex. There are also good arguments for a number theoretic quantization of the momenta in  $M^2$ .

The natural expectation from  $M^8 - H$  duality is that the selection of preferred  $M^2$  implies a reduction of symmetries to those of  $M^2 \times E^6$  and  $M^2 \times E^2 \times CP_2$ . Could the equivalence of  $M^8$  and  $H$  descriptions force the reduction of  $M^4$  momentum to  $M^2$  momentum implied also by the generalized eigen value equation for the modified Dirac operator at wormhole throats?

### The moduli space associated with the choice of $M^2$

Lorentz invariance requires that one must have moduli space of  $CDs$  with fixed tips defined as  $SO(3,1)/SO(1) \times SO(2)$  characterizing different choices of  $M^2$ . Maximal Lorentz invariance requires the association of this moduli space to all lines of the generalized Feynman graph. It is easy to deduce that this space is actually the hyperboloid of 5-D Minkowski space. The moduli space is 4-dimensional and has Euclidian signature of the metric. This follows from the fact that  $SO(3,1)$  has Euclidian signature as a surface in the four-fold Cartesian power  $H(1,3)^4$  of Lobatchevski space with points identified as four time-like unit vectors defining rows of the matrix representing Lorentz transformation. This surface is defined by the 6 orthogonality conditions for the rows of the Lorentz transformation matrix constraints stating the orthogonality of the 4 unit vectors. The Euclidian signature fixes the identification of the moduli space as  $H(1,5)$  having Euclidian signature of metric. The 10-D isometry group  $SO(1,5)$  of the moduli space acts as symmetries of 5-D Minkowski space (note that the conformal group of  $M^4$  is  $SO(2,4)$ ). The non-compactness of this space does not favor the idea of wave function in moduli degrees of freedom.

Concerning the interpretation of pseudo-momenta it is best to be cautious and make only questions. Should one assume that  $M^2$  for the exchanged particle is fixed by the initial and final momenta of the particle emitting it? How to fix in this kind of situation a unique coordinate frame in which the number theoretic quantization of exchanged momenta takes place? Could it be the rest frame for the initial state of the emitting particle so that one should allow also boosts of the number theoretically preferred momenta? Should one only assume the number theoretically preferred mass values for the exchanged particle but otherwise allow the hyperbolic angle characterizing the energy vary freely?

### 9.2.5 Does $M^8 - H$ duality generalize the duality between twistor and momentum twistor descriptions?

$M^8 - H$  duality is intuitively analogous to the duality of elementary wave mechanics meaning that one can use either x-space or momentum space to describe particles.  $M^8$  is indeed the tangent space of  $H$  and one could say that  $M^8 - H$  duality assigns to a 4-surface in  $H$  its "momentum" or tangent as a 4-surface in  $M^8$ . The more concrete identification of  $M^8$  as cotangent bundle of  $H$  so that its points would correspond to 8-momenta: this very naive picture is of course not correct.

$M^8 - H$  duality suggests that the descriptions using isometry groups of  $M^4 \times E^4$  and  $M^4 \times CP_2$  -or as the special role of  $M^2$  suggests - those of  $M^2 \times E^6$  and  $M^2 \times E^2 \times CP_2$  should be equivalent. The interpretation in hadron physics context would be that  $SO(4)$  is the counterpart of color group in low energy hadron physics acting on strong isospin degrees of freedom and  $SU(3)$  that of QCD description useful at high energies.  $SO(4)$  is indeed used in old fashioned hadron physics when quarks and gluons had not yet been introduced. Skyrme model is one example.

The obvious question is whether the duality between descriptions based on twistors and momentum space twistors generalizes to  $M^8 - H$  duality. The basic objection is that the charges and their duals should correspond to the same Lie algebra- or rather Kac-Moody algebra. This is however not the case. For the massless option one has  $SO(2) \times SU(3)$  at H-side and  $SO(2) \times SO(4)$  or  $SO(6)$  and  $M^8$  side. This suggests that  $M^8 - H$  duality is analogous to the duality between descriptions using twistors and momentum space twistors and transforms the local currents  $J_0$  to non-local currents  $J_1$  and vice versa. This duality would be however be more general in the sense that would relate Yangian symmetries with different Kac-Moody groups transforming locality to non-locality and vice versa. This interpretation is consistent with the fact that the groups  $SO(2) \times SO(4)$ ,  $SO(6)$  and



$SO(2) \times SU(3)$  have same rank and the standard construction of Kac-Moody generators in terms of exponentials of the Cartan algebra involves only different weights in the exponentials.

If  $M^8 - H$  duality has something to do with the duality between descriptions using twistors and momentum space twistors involved with Yangian symmetry, it should be consistent with the basic aspects of the latter duality. The following arguments provide support for this.

1.  $SO(4)$  should appear as a dynamical symmetry at  $M^4 \times CP_2$  side and  $SU(3)$  at  $M^8$  side (where it indeed appears as both subgroup of isometries and as tangent space group respecting the choice of  $M^2$ . One could consider the breaking of  $SO(4)$  to the subgroup corresponding to vectorial transformations and interpreted in terms of electroweak vectorial  $SU(2)$ : this would conform with conserved vector current hypothesis and partially conserved axial current hypothesis. The  $U(1)$  factor assignable to Kähler form is also present and allows Kac-Moody variant and an extension to Yangian.
2. The heuristics of twistorial approach suggests that the roles of currents  $J_0$  and their non-local duals  $J_1$  in Minkowski space are changed in the transition from  $H$  description to  $M^8$  description in the sense that the non-local currents  $J_1$  in  $H$  description become local currents in 8-momentum space (or 4-momentum +strong isospin) in  $M^8$  description and  $J_0$  becomes non-local one. In the case of hadron physics the non-local charges assignable to hadrons as collections of partons would become local charges meaning that one can assign them to partonic 2-surfaces at boundaries of  $CDs$  assigned to  $M^8$ : this says that hadrons are the only possible final states of particle reactions. By the locality it would be impossible to decompose momentum and strong isospin to a collection of momenta and strong isospins assigned to partons.
3. In  $H$  description it would be impossible to do decompose quantum numbers to those of quarks and gluons at separate uncorrelated partonic 2-surfaces representing initial and final states of particle reaction. A possible interpretation would be in terms of monopole confinement accompanying electroweak and color confinement: single monopole is not a particle. In  $M^4 \times E^4$  monopoles must be also present since induced Kähler forms are identical. The Kähler form represents magnetic monopole in  $E^4$  and breaks its translational symmetry and also selects unique  $M^4 \times E^4$  decomposition.
4. Since the physics should not depend on its description, color should be confined also now. Indeed, internal quantum numbers should be assigned in  $M^8$  picture to a wave function in  $M^2 \times E^6$  and symmetries would correspond to  $SO(1,1) \times SO(6)$  or - if broken- to those of  $SO(1,1) \times G$ ,  $G = SO(2) \times SO(4)$  or  $G = SO(3) \times SO(3)$ . Color would be completely absent in accordance with the idea that fundamental observable objects are color singlets. Instead of color one would have  $SO(4)$  quantum numbers and  $SO(4)$  confinement: note that the rank of this group crucial for Kac-Moody algebra construction is same as that of  $SU(3)$ .

It is not clear whether the numbers of particle states should be same for  $SO(4)$  and  $SU(3)$ . If so, quark triplet should correspond to doublet and singlet for strong vectorial isospin in  $M^8$  picture. Gluons would correspond to  $SU(2)_V$  multiplets contained by color octet and would therefore contain also other representations than adjoint. This could make sense in composite particle interpretation.

5. For  $M^2 \times E^2$  longitudinal momentum and helicity would make sense and one could speak of massless strong isospin at  $M^8$  side and massless color at  $H$ -side: note that massless color is the only possibility. For  $M^2 \times SO(6)$  option one would have 15-D adjoint representation of  $SO(6)$  decomposing as  $3 \times 3 + 3 \times 1 + 1 \times 3$  under  $SO(3) \times SO(3)$ . This could be interpreted in terms of spin and vectorial isospin for massive particles so that the multiplets would relate to weak gauge bosons and Higgs boson singlet and triplet plus its pseudoscalar variant. For 4-D representation of  $SO(6)$  one would have  $2 \times 2$  decomposition having interpretation in terms of spin and vectorial isospin.

Massive spin would be associated as a local notion with  $M^2 \times E^3$  and would be essentially 5-D concept. At  $H$  side massive particle would make sense only as a non-local notion with four-momentum and mass represented as a non-local operator.

These arguments indeed encourage to think that  $M^8 - H$  duality could be the analog for the duality between the descriptions in terms of twistors and momentum twistors. In this case the Kac-Moody algebras are however not identical since the isometry groups are not identical.

### 9.3 Some mathematical details about Grassmannian formalism

In the following I try to summarize my amateurish understanding about the mathematical structure behind the Grassmann integral approach. The representation summarizes what I have gathered from the articles of Arkani-Hamed and collaborators [?, ?]. These articles are rather sketchy and the article of Bullimore provides additional details [?] related to soft factors. The article of Mason and Skinner provides excellent introduction to super-twistors [?] and dual super-conformal invariance. I apologize for unavoidable errors.

Before continuing a brief summary about the history leading to the articles of Arkani-Hamed and others is in order. This summary covers only those aspects which I am at least somewhat familiar with and leaves out many topics about existence which I am only half-conscious.

1. It is convenient to start by summarizing the basic facts about bi-spinors and their conjugates allowing to express massless momenta as  $p^{aa'} = \lambda_a \tilde{\lambda}_{a'}$  with  $\tilde{\lambda}$  defined as complex conjugate of  $\lambda$  and having opposite chirality. When  $\lambda$  is scaled by a complex number  $\tilde{\lambda}$  suffers an opposite scaling. The bi-spinors allow the definition of various inner products

$$\begin{aligned} \langle \lambda, \mu \rangle &= \epsilon_{ab} \lambda^a \mu^b, \\ [\tilde{\lambda}, \tilde{\mu}] &= \epsilon_{a'b'} \lambda^{a'} \mu^{b'}, \\ p \cdot q &= \langle \lambda, \mu \rangle [\tilde{\lambda}, \tilde{\mu}], \quad (q_{aa'} = \mu_a \tilde{\mu}_{a'}). \end{aligned} \quad (9.3.1)$$

If the particle has spin one can assign it a positive or negative helicity  $h = \pm 1$ . Positive helicity can be represented by introducing arbitrary negative (positive) helicity bispinor  $\mu_a$  ( $\mu_{a'}$ ) not parallel to  $\lambda_a$  ( $\mu_{a'}$ ) so that one can write for the polarization vector

$$\begin{aligned} \epsilon_{aa'} &= \frac{\mu_a \tilde{\lambda}_{a'}}{\langle \mu, \lambda \rangle}, \quad \text{positive helicity}, \\ \epsilon_{aa'} &= \frac{\lambda_a \tilde{\mu}_{a'}}{[\tilde{\mu}, \tilde{\lambda}]}, \quad \text{negative helicity}. \end{aligned} \quad (9.3.2)$$

In the case of momentum twistors the  $\mu$  part is determined by different criterion to be discussed later.

2. Tree amplitudes are considered and it is convenient to drop the group theory factor  $Tr(T_1 T_2 \cdots T_n)$ . The starting point is the observation that tree amplitude for which more than  $n - 2$  gluons have the same helicity vanish. MHV amplitudes have exactly  $n - 2$  gluons of same helicity- taken by a convention to be negative- have extremely simple form in terms of the spinors and reads as

$$A_n = \frac{\langle \lambda_x, \lambda_y \rangle^4}{\prod_{i=1}^n \langle \lambda_i, \lambda_{i+1} \rangle} \quad (9.3.3)$$

When the sign of the helicities is changed  $\langle \dots \rangle$  is replaced with  $[\dots]$ .

3. The article of Witten [?] proposed that twistor approach could be formulated as a twistor string theory with string world sheets "living" in 6-dimensional  $CP_3$  possessing Calabi-Yau structure and defining twistor space. In this article Witten introduced what is known as half Fourier transform allowing to transform momentum integrals over light-cone to twistor integrals. This operation makes sense only in space-time signature  $(2, 2)$ . Witten also demonstrated that maximal helicity violating (MHV) twistor amplitudes (two gluons with negative helicity) with  $n$  particles with  $k + 2$  negative helicities and  $l$  loops correspond in this approach to holomorphic 2-surfaces defined by polynomials of degree  $D = k - 1 + l$ , where the genus of the surface satisfies  $g \leq l$ . AdS/CFT duality provides a second stringy approach to  $\mathcal{N} = 4$  theory allowing to understand the scattering amplitudes in terms of Wilson loops with light-like edges: about this I have nothing to say. In any case, the generalization of twistor string theory to TGD context is highly attractive idea and will be considered later.
4. In the article [?] Cachazo, Svrcek, and Witten propose the analog of Feynman diagrammatics in which MHV amplitudes can be used as analogs of vertices and ordinary  $1/P^2$  propagator as propagator to construct tree diagrams with arbitrary number of negative helicity gluons. This approach is not symmetric with respect to the change of the sign of helicities since the amplitudes with two positive helicities are constructed as tree diagrams. The construction is non-trivial because one must analytically continue the on mass shell tree amplitudes to off mass shell momenta. The problem is how to assign a twistor to these momenta. This is achieved by introducing an arbitrary twistor  $\eta^{a'}$  and defining  $\lambda_a$  as  $\lambda_a = p_{aa'}\eta^{a'}$ . This works for both massless and massive case. It however leads to a loss of the manifest Lorentz invariance. The paper however argues and the later paper [?, ?] shows rigorously that the loss is only apparent. In this paper also BCFW recursion formula is introduced allowing to construct tree amplitudes recursively by starting from vertices with 2 negative helicity gluons. Also the notion which has become known as BCFW bridge representing the massless exchange in these diagrams is introduced. The tree amplitudes are not tree amplitudes in gauge theory sense where correspond to leading singularities for which 4 or more lines of the loop are massless and therefore collinear. What is important that the very simple MHV amplitudes become the building blocks of more complex amplitudes.
5. The next step in the progress was the attempt to understand how the loop corrections could be taken into account in the construction BCFW formula. The calculation of loop contributions to the tree amplitudes revealed the existence of dual super-conformal symmetry which was found to be possessed also by BCFW tree amplitudes besides conformal symmetry. Together these symmetries generate infinite-dimensional Yangian symmetry [?].
6. The basic vision of Arkani-Hamed and collaborators is that the scattering amplitudes of  $\mathcal{N} = 4$  SYM are constructible in terms of leading order singularities of loop diagrams. These singularities are obtained by putting maximum number of momenta propagating in the lines of the loop on mass shell. The non-leading singularities would be induced by the leading singularities by putting smaller number of momenta on mass shell are dictated by these terms. A related idea serving as a starting point in [?] is that one can define loop integrals as residue integrals in momentum space. If I have understood correctly, this means that one can imagine the possibility that the loop integral reduces to a lower dimensional integral for on mass shell particles in the loops: this would resemble the approach to loop integrals based on unitarity and analyticity. In twistor approach these momentum integrals defined as residue integrals transform to residue integrals in twistor space with twistors representing massless particles. The basic discovery is that one can construct leading order singularities for  $n$  particle scattering amplitude with  $k + 2$  negative helicities as Yangian invariants  $Y_{n,k}$  for momentum twistors and invariants constructed from them by canonical operations changing  $n$  and  $k$ . The correspondence  $k = l$  does not hold true for the more general amplitudes anymore.

### 9.3.1 Yangian algebra and its super counterpart

The article of Witten [?] gives a nice discussion of the Yangian algebra and its super counterpart. Here only basic formulas can be listed and the formulas relevant to the super-conformal case are given.

### Yangian algebra

Yangian algebra  $Y(G)$  is associative Hopf algebra. The elements of Yangian algebra are labelled by non-negative integers so that there is a close analogy with the algebra spanned by the generators of Virasoro algebra with non-negative conformal weight. The Yangian symmetry algebra is defined by the following relations for the generators labeled by integers  $n = 0$  and  $n = 1$ . The first half of these relations discussed in very clear manner in [?] follows uniquely from the fact that adjoint representation of the Lie algebra is in question

$$[J^A, J^B] = f_C^{AB} J^C \quad , \quad [J^A, J^{(1)B}] = f_C^{AB} J^{(1)C} \quad . \quad (9.3.4)$$

Besides this Serre relations are satisfied. These have more complex and read as

$$\begin{aligned} & [J^{(1)A}, [J^{(1)B}, J^C]] + [J^{(1)B}, [J^{(1)C}, J^A]] + [J^{(1)C}, [J^{(1)A}, J^B]] \\ & \quad = \frac{1}{24} f^{ADK} f^{BEL} f^{CFM} f_{KLM} \{J_D, J_E, J_F\} \quad , \\ & [[J^{(1)A}, J^{(1)B}], [J^C, J^{(1)D}]] + [[J^{(1)C}, J^{(1)D}], [J^A, J^{(1)B}]] \\ & \quad = \frac{1}{24} f^{AGL} f^{BEM} f_K^{CD} \\ & \quad + f^{CGL} f^{DEM} f_K^{AB} f^{KFN} f_{LMN} \{J_G, J_E, J_F\} \quad . \end{aligned} \quad (9.3.5)$$

The indices of the Lie algebra generators are raised by invariant, non-degenerate metric tensor  $g_{AB}$  or  $g^{AB}$ .  $\{A, B, C\}$  denotes the symmetrized product of three generators.

Repeated commutators allow to generate the entire algebra whose elements are labeled by non-negative integer  $n$ . The generators obtain in this manner are  $n$ -local operators arising in  $(n - 1)$ -commutator of  $J^{(1)}$ :s. For  $SU(2)$  the Serre relations are trivial. For other cases the first Serre relation implies the second one so the relations are redundant. Why Witten includes it is for the purposed of demonstrating the conditions for the existence of Yangians associated with discrete one-dimensional lattices (Yangians exists also for continuum one-dimensional index).

Discrete one-dimensional lattice provides under certain consistency conditions a representation for the Yangian algebra. One assumes that each lattice point allows a representation  $R$  of  $J^A$  so that one has  $J^A = \sum_i J_i^A$  acting on the infinite tensor power of the representation considered. The expressions for the generators  $J^{1A}$  are given as

$$J^{(1)A} = f_{BC}^A \sum_{i < j} J_i^B J_j^C \quad . \quad (9.3.6)$$

This formula gives the generators in the case of conformal algebra. This representation exists if the adjoint representation of  $G$  appears only one in the decomposition of  $R \otimes R$ . This is the case for  $SU(N)$  if  $R$  is the fundamental representation or is the representation of by  $k^{th}$  rank completely antisymmetric tensors.

This discussion does not apply as such to  $\mathcal{N} = 4$  case the number of lattice points is finite and corresponds to the number of external particles so that cyclic boundary conditions are needed guarantee that the number of lattice points reduces effectively to a finite number. Note that the Yangian in color degrees of freedom does not exist for  $SU(N)$  SYM.

As noticed, Yangian algebra is a Hopf algebra and therefore allows co-product. The co-product  $\Delta$  is given by

$$\begin{aligned} \Delta(J^A) & = J^A \otimes 1 + 1 \otimes J^A \quad , \\ \Delta(J^{(1)A}) & = J^{(1)A} \otimes 1 + 1 \otimes J^{(1)A} + f_{BC}^A J^B \otimes J^C \quad per, \end{aligned} \quad (9.3.7)$$

$\Delta$  allows to imbed Lie algebra to the tensor product in non-trivial manner and the non-triviality comes from the addition of the dual generator to the trivial co-product. In the case that the single spin representation of  $J^{(1)A}$  is trivial, the co-product gives just the expression of the dual generator using the ordinary generators as a non-local generator. This is assumed in the recent case and also for the generators of the conformal Yangian.

**Super-Yangian**

Also the Yangian extensions of Lie super-algebras make sense. From the point of physics especially interesting Lie super-algebras are  $SU(m|m)$  and  $U(m|m)$ . The reason is that  $PSU(2, 2|4)$  ( $P$  refers to "projective") acting as super-conformal symmetries of  $\mathcal{N} = 4$  SYM and this super group is a real form of  $PSU(4|4)$ . The main point of interest is whether this algebra allows Yangian representation and Witten demonstrated that this is indeed the case [?].

These algebras are  $Z_2$  graded and decompose to bosonic and fermionic parts which in general correspond to  $n$ - and  $m$ -dimensional representations of  $U(n)$ . The representation associated with the fermionic part dictates the commutation relations between bosonic and fermionic generators. The anticommutator of fermionic generators can contain besides identity also bosonic generators if the symmetrized tensor product in question contains adjoint representation. This is the case if fermions are in the fundamental representation and its conjugate. For  $SU(3)$  the symmetrize tensor product of adjoint representations contains adjoint (the completely symmetric structure constants  $d_{abc}$ ) and this might have some relevance for the super  $SU(3)$  symmetry.

The elements of these algebras in the matrix representation (no Grassmann parameters involved) can be written in the form

$$x = \begin{pmatrix} a & b \\ c & d \end{pmatrix} .$$

$a$  and  $d$  representing the bosonic part of the algebra are  $n \times n$  matrices and  $m \times m$  matrices corresponding to the dimensions of bosonic and fermionic representations.  $b$  and  $c$  are fermionic matrices are  $n \times m$  and  $m \times n$  matrices, whose anticommutator is the direct sum of  $n \times n$  and  $n \times n$  matrices. For  $n = m$  bosonic generators transform like Lie algebra generators of  $SU(n) \times SU(n)$  whereas fermionic generators transform like  $n \otimes \bar{n} \oplus \bar{n} \otimes n$  under  $SU(n) \times SU(n)$ . Supertrace is defined as  $Str(x) = Tr(a) - Tr(b)$ . The vanishing of Str defines  $SU(n|m)$ . For  $n \neq m$  the super trace condition removes identity matrix and  $PU(n|m)$  and  $SU(n|m)$  are same. That this does not happen for  $n = m$  is an important delicacy since this case corresponds to  $\mathcal{N} = 4$  SYM. If any two matrices differing by an additive scalar are identified (projective scaling as now physical effect) one obtains  $PSU(n|n)$  and this is what one is interested in.

Witten shows that the condition that adjoint is contained only once in the tensor product  $R \otimes \bar{R}$  holds true for the physically interesting representations of  $PSU(2, 2|4)$  so that the generalization of the bilinear formula can be used to define the generators of  $J^{(1)A}$  of super Yangian of  $PU(2, 2|4)$ . The defining formula for the generators of the Super Yangian reads as

$$\begin{aligned} J_C^{(1)} &= g_{CC'} J^{(1)C'} = g_{CC'} f_{AB}^{C'} \sum_{i < j} J_i^A J_j^B \\ &= g_{CC'} f_{AB}^{C'} g^{AA'} g^{BB'} \sum_{i < j} J_{A'}^i J_{B'}^j . \end{aligned} \tag{9.3.8}$$

Here  $g_{AB} = Str(J_A J_B)$  is the metric defined by super trace and distinguishes between  $PSU(4|4)$  and  $PSU(2, 2|4)$ . In this formula both generators and super generators appear.

**Generators of super-conformal Yangian symmetries**

The explicit formula for the generators of super-conformal Yangian symmetries in terms of ordinary twistors is given by

$$\begin{aligned}
j_B^A &= \sum_{i=1}^n Z_i^A \partial_{Z_i^B} , \\
j_B^{(1)A} &= \sum_{i<j} (-1)^C \left[ Z_i^A \partial_{Z_j^C} Z_j^C \partial_{Z_j^B} \right] .
\end{aligned} \tag{9.3.9}$$

This formula follows from completely general formulas for the Yangian algebra discussed above and allowing to express the dual generators  $j_N^{(1)}$  as quadratic expression of  $j_N$  involving structures constants. In this rather sketchy formula twistors are ordinary twistors. Note however that in the recent case the lattice is replaced with its finite cutoff corresponding to the external particles of the scattering amplitude. This probably corresponds to the assumption that for the representations considered only finite number of lattice points correspond to non-trivial quantum numbers or to cyclic symmetry of the representations.

In the expression for the amplitudes the action of transformations is on the delta functions and by partial integration one finds that a total divergence results. This is easy to see for the linear generators but not so for the quadratic generators of the dual super-conformal symmetries. A similar formula but with  $j_B^A$  and  $j_B^{(1)A}$  interchanged applies in the representation of the amplitudes as Grassmann integrals using ordinary twistors. The verification of the generalization of Serre formula is also straightforward.

### 9.3.2 Twistors and momentum twistors and super-symmetrization

In [?] the basics of twistor geometry are summarized. Despite this it is perhaps good to collect the basic formulas here.

#### Conformally compactified Minkowski space

Conformally compactified Minkowski space can be described as  $SO(2, 4)$  invariant (Klein) quadric

$$T^2 + V^2 - W^2 - X^2 - Y^2 - Z^2 = 0 . \tag{9.3.10}$$

The coordinates  $(T, V, W, X, Y, Z)$  define homogenous coordinates for the real projective space  $RP^5$ . One can introduce the projective coordinates  $X_{\alpha\beta} = -X_{\beta\alpha}$  through the formulas

$$\begin{aligned}
X_{01} &= W - V , & X_{02} &= Y + iX , & X_{03} &= \frac{i}{\sqrt{2}}T - Z , \\
X_{12} &= -\frac{i}{\sqrt{2}}(T + Z) , & X_{13} &= Y - iX , & X_{23} &= \frac{1}{2}(V + W) .
\end{aligned} \tag{9.3.11}$$

The motivation is that the equations for the quadric defining the conformally compactified Minkowski space can be written in a form which is manifestly conformally invariant:

$$\epsilon^{\alpha\beta\gamma\delta} X_{\alpha\beta} X_{\gamma\delta} = 0 . \tag{9.3.12}$$

The points of the conformally compactified Minkowski space are null separated if and only if the condition

$$\epsilon^{\alpha\beta\gamma\delta} X_{\alpha\beta} Y_{\gamma\delta} = 0 \tag{9.3.13}$$

holds true.

### Correspondence with twistors and infinity twistor

One ends up with the correspondence with twistors by noticing that the condition is equivalent with the possibility to expression  $X_{\alpha\beta}$  as

$$X_{\alpha\beta} = A_{[\alpha}B_{\beta]} \ , \quad (9.3.14)$$

where brackets refer to antisymmetrization. The complex vectors  $A$  and  $B$  define a point in twistor space and are defined only modulo scaling and therefore define a point of twistor space  $CP_3$  defining a covering of 6-D Minkowski space with metric signature  $(2, 4)$ . This corresponds to the fact that the Lie algebras of  $SO(2, 4)$  and  $SU(2, 2)$  are identical. Therefore the points of conformally compactified Minkowski space correspond to lines of the twistor space defining spheres  $CP_1$  in  $CP_3$ .

One can introduce a preferred scale for the projective coordinates by introducing what is called infinity twistor (actually a pair of twistors is in question) defined by

$$I_{\alpha\beta} = \begin{pmatrix} \epsilon^{A'B'} & 0 \\ 0 & 0 \end{pmatrix} \ . \quad (9.3.15)$$

Infinity twistor represents the projective line for which only the coordinate  $X_{01}$  is non-vanishing and chosen to have value  $X_{01} = 1$ .

One can define the contravariant form of the infinite twistor as

$$I^{\alpha\beta} = \epsilon^{\alpha\beta\gamma\delta} I_{\gamma\delta} = \begin{pmatrix} 0 & 0 \\ 0 & \epsilon^{AB} \end{pmatrix} \ . \quad (9.3.16)$$

Infinity twistor defines a representative for the conformal equivalence class of metrics at the Klein quadric and one can express Minkowski distance as

$$(x - y)^2 = \frac{X^{\alpha\beta} Y_{\alpha\beta}}{I_{\alpha\beta} X^{\alpha\beta} I_{\mu\nu} Y^{\mu\nu}} \ . \quad (9.3.17)$$

Note that the metric is necessary only in the denominator. In twistor notation the distance can be expressed as

$$(x - y)^2 = \frac{\epsilon(A, B, C, D)}{\langle AB \rangle \langle CD \rangle} \ . \quad (9.3.18)$$

Infinite twistor  $I_{\alpha\beta}$  and its contravariant counterpart project the twistor to its primed and unprimed parts usually denoted by  $\mu^{A'}$  and  $\lambda^A$  and defined spinors with opposite chiralities.

### Relationship between points of $M^4$ and twistors

In the coordinates obtained by putting  $X_{01} = 1$  the relationship between space-time coordinates  $x^{AA'}$  and  $X^{\alpha\beta}$  is

$$X_{\alpha\beta} = \begin{pmatrix} -\frac{1}{2}\epsilon^{A'B'}x^2 & -ix_{B'}^{A'} \\ ix_A^{B'} & \epsilon_{A,B} \end{pmatrix} \ , \quad X^{\alpha\beta} = \begin{pmatrix} \epsilon_{A'B'}x^2 & -ix_{A'}^B \\ ix_{B'}^A & -\frac{1}{2}\epsilon^{AB}x^2 \end{pmatrix} \ , \quad (9.3.19)$$

If the point of Minkowski space represents a line defined by twistors  $(\mu_U, \lambda_U)$  and  $(\mu_V, \lambda_V)$ , one has

$$x^{AC'} = i \frac{(\mu_V \lambda_U - \mu_U \lambda_V)^{AC'}}{\langle UV \rangle} \quad (9.3.20)$$

The twistor  $\mu$  for a given point of Minkowski space in turn is obtained from  $\lambda$  by the twistor formula by

$$\mu^{A'} = -ix^{AA'} \lambda_A \ . \quad (9.3.21)$$

### Generalization to the super-symmetric case

This formalism has a straightforward generalization to the super-symmetric case.  $CP_3$  is replaced with  $CP_{3|4}$  so that Grassmann parameters have four components. At the level of coordinates this means the replacement  $[W_I] = [W_\alpha, \chi_\alpha]$ . Twistor formula generalizes to

$$\mu^{A'} = -ix^{AA'} \lambda_A \ , \quad \chi_\alpha = \theta_\alpha^A \lambda_A \ . \quad (9.3.22)$$

The relationship between the coordinates of chiral super-space and super-twistors generalizes to

$$(x, \theta) = \left( i \frac{(\mu_V \lambda_U - \mu_U \lambda_V)}{\langle UV \rangle}, \frac{(\chi_V \lambda_U - \chi_U \lambda_V)}{\langle UV \rangle} \right) \quad (9.3.23)$$

The above summarized formulas can be applied to super-symmetric variants of momentum twistors to deduce the relationship between region momenta  $x$  assigned with edges of polygons and twistors assigned with the ends of the light-like edges. The explicit formulas are represented in [?] . The geometric picture is following. The twistors at the ends of the edge define the twistor pair representing the region momentum as a line in twistor space and the intersection of the twistor lines assigned with the region momenta define twistor representing the external momenta of the graph in the intersection of the edges.

### Basic kinematics for momentum twistors

The supersymmetrization involves replacement of multiplets with super-multiplets

$$\Phi(\lambda, \tilde{\lambda}, \eta) = G^+(\lambda, \tilde{\lambda}) + \eta_i \Gamma^a \lambda, \tilde{\lambda} + \dots + \epsilon_{abcd} \eta^a \eta^b \eta^c \eta^d G^-(\lambda, \tilde{\lambda}) \ . \quad (9.3.24)$$

Momentum twistors are dual to ordinary twistors and were introduced by Hodges. The light-like momentum of external particle  $a$  is expressed in terms of the vertices of the closed polygon defining the twistor diagram as

$$p_i^\mu = x_i^\mu - x_{i+1}^\mu = \lambda_i \tilde{\lambda}_i \ , \quad \theta_i - \theta_{i+1} = \lambda_i \eta_i \ . \quad (9.3.25)$$

One can say that massless momenta have a conserved super-part given by  $\lambda_i \eta_i$ . The dual of the super-conformal group acts on the region momenta exactly as the ordinary conformal group acts on space-time and one can construct twistor space for dual region momenta.

Super-momentum conservation gives the constraints

$$\sum p_i = 0 \ , \quad \sum \lambda_i \eta_i = 0 \ . \quad (9.3.26)$$

The twistor diagrams correspond to polygons with edges with lines carrying region momenta and external massless momenta emitted at the vertices.

This formula is invariant under overall shift of the region momenta  $x_a^\mu$ . A natural interpretation for  $x_a^\mu$  is as the momentum entering to the vertex where  $p_a$  is emitted. Overall shift would have interpretation as a shift in the loop momentum.  $x_a^\mu$  in the dual coordinate space is associated with the line  $Z_{a-1} Z_a$  in the momentum twistor space. The lines  $Z_{a-1} Z_a$  and  $Z_a Z_{a+1}$  intersect at  $Z_a$  representing a light-like momentum vector  $p_a^\mu$ .

The brackets  $\langle abcd \rangle \equiv \epsilon_{IJKL} Z_a^I Z_b^J Z_c^K Z_d^L$  define fundamental bosonic conformal invariants appearing in the tree amplitudes as basic building blocks. Note that  $Z_a$  define points of 4-D complex twistor space to be distinguished from the projective twistor space  $CP_3$ .  $Z_a$  define projective coordinates for  $CP_3$  and one of the four complex components of  $Z_a$  is redundant and one can take  $Z_a^0 = 1$  without a loss of generality.



### 9.3.3 Brief summary of the work of Arkani-Hamed and collaborators

The following comments are an attempt to summarize my far from complete understanding about what is involved with the representation as contour integrals. After that I shall describe in more detail my impressions about what has been done.

#### Limitations of the approach

Consider first the limitations of the approach.

1. The basis idea is that the representation for tree amplitudes generalizes to loop amplitudes. On other words, the amplitude defined as a sum of Yangian invariants expressed in terms of Grassmann integrals represents the sum of loops up to some maximum loop number. The problem is here that shifts of the loop momenta are essential in the UV regularization procedure. Fixing the coordinates  $x_1, \dots, x_n$  having interpretation as momenta associated with lines in the dual coordinate space allows to eliminate the non-uniqueness due to the common shift of these coordinates.
2. It is not however not possible to identify loop momentum as a loop momentum common to different loop integrals unless one restricts to planar loops. Non-planar diagrams are obtained from a planar diagram by permuting the coordinates  $x_i$  but this means that the unique coordinate assignment is lost. Therefore the representation of loop integrands as Grassmann integrals makes sense only for planar diagrams. From TGD point of view one could argue that this is one good reason for restricting the loops so that they are for on mass shell particles with non-parallel on mass shell four-momenta and possibly different sign of energies for given wormhole contact representing virtual particle.
3. IR regularization is needed even in  $\mathcal{N} = 4$  for SYM given by "moving out on the Coulomb branch theory" so that IR singularities remain the problem of the theory.

#### What has been done?

The article proposes a generalization of the BCFW recursion relation for tree diagrams of  $\mathcal{N} = 4$  for SYM so that it applies to planar diagrams with a summation over an arbitrary number of loops.

1. The basic goal of the article is to generalize the recursion relations of tree amplitudes so that they would apply to loop amplitudes. The key idea is following. One can formally represent loop integrand as a contour integral in complex plane whose coordinate parameterizes the deformations  $Z_n \rightarrow Z_n + \epsilon Z_{n-1}$  and re-interpret the integral as a contour integral with oppositely oriented contour surrounding the rest of the complex plane which can be imagined also as being mapped to Riemann sphere. What happens only the poles which correspond to lower number of loops contribute this integral. One obtains a recursion relation with respect to loop number. This recursion seems to be the counterpart for the recursive construction of the loops corrections in terms of absorptive parts of amplitudes with smaller number of loop using unitarity and analyticity.
2. The basic challenge is to deduce the Grassmann integrands as Yangian invariants. From these one can deduce loop integrals by integration over the four momenta associated with the lines of the polygonal graph identifiable as the dual coordinate variables  $x_a$ . The integration over loop momenta can induce infrared divergences breaking Yangian symmetry. The big idea here is that the operations described above allow to construct loop amplitudes from the Yangian invariants defining tree amplitudes for a larger number of particles by removing external particles by fusing them to form propagator lines and by using the BCFW bridge to fuse lower-dimensional invariants. Hence the usual iterative procedure (bottom-up) used to construct scattering amplitudes is replaced with a recursive procedure (top-down). Of course, once lower amplitudes has been constructed they can be used to construct amplitudes with higher particle number.
3. The first guess is that the recursion formula involves the same lower order contributions as in the case of tree amplitudes. These contributions have interpretation as factorization of channels involving single particle intermediate states. This would however allow to reduce loop amplitudes

to 3-particle loop amplitudes which vanish in  $\mathcal{N} = 4$  SYM by the vanishing of coupling constant renormalization. The additional contribution is necessary and corresponds to a source term identifiable as a "forward limit" of lower loop integrand. These terms are obtained by taking an amplitude with two additional particles with opposite four-momenta and forming a state in which these particles are entangled with respect to momentum and other quantum numbers. Entanglement means integral over the massless momenta on one hand. The insertion brings in two momenta  $x_a$  and  $x_b$  and one can imagine that the loop is represented by a branching of propagator line. The line representing the entanglement of the massless states with massless momentum define the second branch of the loop. One can of course ask whether only massless momentum in the second branch. A possible interpretation is that this state is expressible by unitarity in terms of the integral over light-like momentum.

4. The recursion formula for the loop amplitude  $M_{n,k,l}$  involves two terms when one neglects the possibility that particles can also suffer trivial scattering (cluster decomposition). This term basically corresponds to the Yangian invariance of  $n$  arguments identified as Yangian invariant of  $n - 1$  arguments with the same value of  $k$ .
  - (a) The first term corresponds to single particle exchange between particle groups obtained by splitting the polygon at two vertices and corresponds to the so called BCFW bridge for tree diagrams. There is a summation over different splittings as well as a sum over loop numbers and dimensions  $k$  for the Grassmann planes. The helicities in the two groups are opposite.
  - (b) Second term is obtained from an amplitude obtained by adding of two massless particles with opposite momenta and corresponds to  $n + 2, k + 1, l - 1$ . The integration over the light-like momentum together with other operations implies the reduction  $n + 2 \rightarrow n$ . Note that the recursion indeed converges. Certainly the allowance of added zero energy states with a finite number of particles is necessary for the convergence of the procedure.

### 9.3.4 The general form of Grassmannian integrals

If the recursion formula proposed in [?] is correct, the calculations reduce to the construction of  $N^k MHV$  (super) amplitudes.  $MHV$  refers to maximal helicity violating amplitudes with 2 negative helicity gluons. For  $N^k MHV$  amplitude the number of negative helicities is by definition  $k + 2$  [?] . Note that the total right handed R-charge assignable to 4 super-coordinates  $\eta_i$  of negative helicity gluons can be identified as  $R = 4k$ . BCFW recursion formula [?, ?] allows to construct from MHV amplitudes with arbitrary number of negative helicities.

The basic object of study are the leading singularities of color-stripped  $n$ -particle  $N^k MHV$  amplitudes. The discovery is that these singularities are expressible in terms Yangian invariants  $Y_{n,k}(Z_1, \dots, Z_n)$ , where  $Z_i$  are momentum super-twistors. These invariants are defined by residue integrals over the compact  $nk - 1$ -dimensional complex space  $G(n, k) = U(n)/U(k) \times U(n - k)$  of  $k$ -planes of complex  $n$ -dimensional space.  $n$  is the number of external massless particles,  $k$  is the number negative helicity gluons in the case of  $N^k MHV$  amplitudes, and  $Z_a, i = 1, \dots, n$  denotes the projective 4-coordinate of the super-variant  $CP^{3|4}$  of the momentum twistor space  $CP_3$  assigned to the massless external particles is following.  $Gl(n)$  acts as linear transformations in the  $n$ -fold Cartesian power of twistor space. Yangian invariant  $Y_{n,k}$  is a function of twistor variables  $Z^a$  having values in super-variant  $CP_{3|3}$  of momentum twistor space  $CP_3$  assigned to the massless external particles being simple algebraic functions of the external momenta.

It is also possible to define  $N^k MHV$  amplitudes in terms of Yangian invariants  $L_{n,k+2}(W_1, \dots, W_n)$  by using ordinary twistors  $W_a$  and identical defining formula. The two invariants are related by the formula  $L_{n,k+2}(W_1, \dots, W_n) = M_{MHV}^{tree} \times Y_{n,k}(Z_1, \dots, Z_n)$ . Here  $M_{MHV}^{tree}$  is the tree contribution to the maximally helicity violating amplitude for the scattering of  $n$  particles: recall that these amplitudes contain two negative helicity gluons whereas the amplitudes containing a smaller number of them vanish [?] . One can speak of a factorization to a product of  $n$ -particle amplitudes with  $k - 2$  and 2 negative helicities as the origin of the duality. The equivalence between the descriptions based on ordinary and momentum twistors states the dual conformal invariance of the amplitudes implying Yangian symmetry. It has been conjectured that Grassmannian integrals generate all Yangian invariants.

The formulas for the Grassmann integrals for twistors and momentum twistors appearing in the expressions of  $N^k MHV$  amplitudes are given by following expressions.

1. The integrals  $L_{n,k}(W_1, \dots, W_n)$  associated with  $N^{k-2} MHV$  amplitudes in the description based on ordinary twistors correspond to  $k$  negative helicities and are given by

$$\begin{aligned}
 L_{n,k}(W_1, \dots, W_n) &= \frac{1}{Vol(GL(2))} \int \frac{d^{k \times n} C_{\alpha a}}{(1 \dots k)(2 \dots k+1) \dots (n1 \dots k-1)} \times \\
 &\times \prod_{\alpha=1}^k d^{4|4} Y_{\alpha} \prod_{i=1}^n \delta^{4|4}(W_i - C_{\alpha i} Y_{\alpha}) .
 \end{aligned}
 \tag{9.3.27}$$

Here  $C_{\alpha a}$  denote the  $n \times k$  coordinates used to parametrize the points of  $G_{k,n}$ .

2. The integrals  $Y_{n,k}(W_1, \dots, W_n)$  associated with  $N^k MHV$  amplitudes in the description based on momentum twistors are defined as

$$Y_{n,k}(Z_1, \dots, Z_n) = \frac{1}{Vol(GL(k))} \times \int \frac{d^{k \times n} C_{\alpha a}}{(1 \dots k)(2 \dots k+1) \dots (n1 \dots k-1)} \times \prod_{\alpha=1}^k \delta^{4|4}(C_{\alpha a} Z_a) .
 \tag{9.3.28}$$

The possibility to select  $Z_a^0 = 1$  implies  $\sum_k C_{\alpha k} = 0$  allowing to eliminate  $C_{\alpha n}$  so that the actual number of coordinates Grassman coordinates is  $nk-1$ . As already noticed,  $L_{n,k+2}(W_1, \dots, W_n) = M_{MHV}^{tree} \times Y_{n,k}(Z_1, \dots, Z_n)$ . Momentum twistors are obviously computationally easier since the value of  $k$  is smaller by two units.

The  $4k$  delta functions reduce the number of integration variables of contour integrals from  $nk$  to  $(n-4)k$  in the bosonic sector (the definition of delta functions involves some delicacies not discussed here). The  $n$  quantities  $(m, \dots, m+k)$  are  $k \times k$ -determinants defined by subsequent columns from  $m$  to  $m+k-1$  of the  $k \times n$  matrix defined by the coordinates  $C_{\alpha a}$  and correspond geometrically to the  $k$ -volumes of the  $k$ -dimensional parallel-pipeds defined by these column vectors. The fact that the scalings of twistor space coordinates  $Z_a$  can be compensated by scalings of  $C_{\alpha a}$  deforming integration contour but leaving the residue integral invariant so that the integral depends on projective twistor coordinates only.

Since the integrand is a rational function, a multi-dimensional residue calculus allows to deduce the values of these integrals as residues associated with the poles of the integrand in a recursive manner. The poles correspond to the zeros of the  $k \times k$  determinants appearing in the integrand or equivalently to singular lower-dimensional parallel-pipeds. It can be shown that local residues are determined by  $(k-2)(n-k-2)$  conditions on the determinants in both cases. The value of the integral depends on the explicit choice of the integration contour for each variable  $C_{\alpha a}$  left when delta functions are taken into account. The condition that a correct form of tree amplitudes is obtained fixes the choice of the integration contours.

For the ordinary twistors  $W$  the residues correspond to projective configurations in  $CP_{k-1}$ , or more precisely in the space  $CP_{k-1}^n / Gl(k)$ , which is  $(k-1)n - k^2$ -dimensional space defining the support for the residues integral.  $Gl(k)$  relates to each other different complex coordinate frames for  $k$ -plane and since the choice of frame does not affect the plane itself, one has  $Gl(k)$  gauge symmetry as well as the dual  $Gl(n-k)$  gauge symmetry.

$CP_{k-1}$  comes from the fact that  $C_{\alpha k}$  are projective coordinates: the amplitudes are indeed invariant under the scalings  $W_i \rightarrow t_i W_i, C_{\alpha i} \rightarrow t C_{\alpha i}$ . The coset space structure comes from the fact that  $Gl(k)$  is a symmetry of the integrand acting as  $C_{\alpha i} \rightarrow \Lambda_{\alpha}^{\beta} C_{\beta i}$ . This analog of gauge symmetry allows to fix  $k$  arbitrarily chosen frame vectors  $C_{\alpha i}$  to orthogonal unit vectors. For instance, one can have  $C_{\alpha i} = \delta_{\alpha i}$  for  $\alpha = i \in 1, \dots, k$ . This choice is discussed in detail in [?] . The reduction to  $CP_{k-1}$  implies the

reduction of the support of the integral to line in the case of MHV amplitudes and to plane in the case of NMHV as one sees from the expression  $d\mu = \prod_{\alpha} d^{4|4} Y_{\alpha} \prod_{i=1}^n \delta^{4|4}(W_i - C_{\alpha i} Y_{\alpha})$ . For  $(i_1, \dots, i_k) = 0$  the vectors  $i_1, \dots, i_k$  belong to  $k - 2$ -dimensional plane of  $CP_{k-1}$ . In the case of NMHV ( $N^2$ MHV) amplitudes this translates at the level of twistors to the condition that the corresponding twistors  $\{i_1, i_2, i_3\}$  ( $\{i_1, i_2, i_3, i_4\}$ ) are collinear (in the same plane) in twistor space. This can be understood from the fact that the delta functions in  $d\mu$  allow to express  $W_i$  in terms of  $k - 1$   $Y_{\alpha}$ :s in this case.

The action of conformal transformations in twistor space reduces to the linear action of  $SU(2, 2)$  leaving invariant Hermitian sesquilinear form of signature  $(2, 2)$ . Therefore the conformal invariance of the Grassmannian integral and its dual variant follows from the possibility to perform a compensating coordinate change for  $C_{\alpha a}$  and from the fact that residue integral is invariant under small deformations of the integration contour. The above described relationship between representations based on twistors and momentum twistors implies the full Yangian invariance.

### 9.3.5 Canonical operations for Yangian invariants

General  $l$ -loop amplitudes can be constructed from the basic Yangian invariants defined by  $N^k$ MHV amplitudes by various operations respecting Yangian invariance apart from possible IR anomalies. There are several operations that one can perform for Yangian invariants  $Y_{n,k}$  and all these operations appear in the recursion formula for planar all loop amplitudes. These operations are described in [?] much better than I could do it so that I will not go to any details. It is possible to add and remove particles, to fuse two Yangian invariants, to merge particles, and to construct from two Yangian invariants a higher invariant containing so called BCFW bridge representing single particle exchange using only twistorial methods.

#### Inverse soft factors

Inverse soft factors add to the diagram a massless collinear particles between particles  $a$  and  $b$  and by definition one has

$$O_{n+1}(a, c, b, \dots) = \frac{\langle ab \rangle}{\langle ac \rangle \langle cb \rangle} O_n(a' b') . \quad (9.3.29)$$

At the limit when the momentum of the added particle vanishes both sides approach the original amplitude. The right-handed spinors and Grassmann parameters are shifted

$$\begin{aligned} \tilde{\lambda}'_a &= \tilde{\lambda}_a + \frac{\langle cb \rangle}{\langle ab \rangle} \tilde{\lambda}_c , & \tilde{\lambda}'_b &= \tilde{\lambda}_b + \frac{\langle ca \rangle}{\langle ba \rangle} \tilde{\lambda}_c , \\ \eta'_a &= \eta_a + \frac{\langle cb \rangle}{\langle ab \rangle} \eta_c , & \eta'_b &= \eta_b + \frac{\langle ca \rangle}{\langle ba \rangle} \eta_c . \end{aligned} \quad (9.3.30)$$

There are two kinds of inverse soft factors.

1. The addition of particle leaving the value  $k$  of negative helicity gluons unchanged means just the re-interpretation

$$Y'_{n,k}(Z_1, \dots, Z_{n-1}, Z_n) = Y_{n-1,k}(Z_1, \dots, Z_{n-1}) \quad (9.3.31)$$

without actual dependence on  $Z_n$ . There is however a dependence on the momentum of the added particle since the relationship between momenta and momentum twistors is modified by the addition obtained by applying the basic rules relating region super momenta and momentum twistors (light-like momentum determines  $\lambda_i$  and twistor equations for  $x_i$  and  $\lambda_i, \eta_i$  determine  $(\mu_i, \chi_i)$ ) is expressible assigned to the external particles [?]. Modifications are needed only for the new vertex and its neighbors.

2. The addition of a particle increasing  $k$  with single unit is a more complex operation which can be understood in terms of a residue of  $Y_{n,k}$  proportional to  $Y_{n-1,k-1}$  and Yangian invariant  $[z_1 \cdots z_5]$  with five arguments constructed from basic Yangian invariants with four arguments. The relationship between the amplitudes is now

$$Y'_{n,k}(\dots, Z_{n-1}Z_n, Z_1 \cdots) = [n-2 \ n-1 \ n \ 1 \ 2] \times Y_{n-1,k-1}(\cdots \hat{Z}_{n-1}, \hat{Z}_1, \cdots) . \quad (9.3.32)$$

Here

$$[abcde] = \frac{\delta^{0|4}(\eta_a \langle bcde \rangle + cyclic)}{\langle abcd \rangle \langle bcde \rangle \langle cdea \rangle \langle deab \rangle \langle eabc \rangle} . \quad (9.3.33)$$

denoted also by  $R(a, b, c, d, e)$  is the fundamental R-invariant appearing in one loop corrections of MHV amplitudes and will appear also in the recursion formulas.  $\langle abcd \rangle$  is the fundamental super-conformal invariant associated with four super twistors defined in terms of the permutation symbol.

$\hat{Z}_{n-1}, \hat{Z}_1$  are deformed momentum twistor variables. The deformation is determined from the relationship between external momenta, region momenta and momentum twistor variables.  $\hat{Z}^1$  is the intersection  $\hat{Z}^1 = (n-2 \ n-1 \ 2) \cap (12)$  of the the line (12) with the plane  $(n-2 \ n-1 \ 2)$  and  $\hat{Z}^{n-1}$  the intersection  $\hat{Z}^1 = (12n) \cap (n-2 \ n-1)$  of the the line  $(n-2 \ n-1)$  with the plane  $(12n)$ . The interpretation for the intersections at the level of ordinary Feynman diagrams is in terms of the collinearity of the four-momenta involved with the underlying box diagram with parallel on mass shell particles. These result from unitarity conditions obtained by putting maximal number of loop momenta on mass shell to give the leading singularities.

The explicit expressions for the momenta are

$$\begin{aligned} \hat{Z}^1 &\equiv (n-2 \ n-1 \ 2) \cap (12)Z_1 = \langle 2 \ n-2 \ n-1 \ n \rangle + Z_2 \langle n-2 \ n-1 \ n \ 1 \rangle , \\ \hat{Z}^{n-1} &\equiv (12n) \cap (n-2 \ n-1) = Z_{n-2} \langle n-2 \ n-1 \ n \ 2 \rangle + Z_{n-1} \langle n \ 1 \ 2 \ n-2 \rangle . \end{aligned} \quad (9.3.34)$$

These intersections also appear in the expressions defining the recursion formula.

### Removal of particles and merge operation

Particles can be also removed. The first manner to remove particle is by integrating over the twistor variable characterizing the particle. This reduces  $k$  by one unit. Merge operation preserves the number of loops but removes a particle particle by identifying the twistor variables of neighboring particles. This operation corresponds to an integral over on mass shell loop momentum at the level of tree diagrams and by Witten's half Fourier transform can be transformed to twistor integral.

The product

$$Y'(Z_1, \cdots Z_n) = Y_1(Z_1, \cdots Z_m) \times Y_2(Z_{m+1}, \cdots Z_n) \quad (9.3.35)$$

of two Yangian invariants is again a Yangian invariant. This is not quite trivial since the dependence of region momenta and momentum twistors on the momenta of external particles makes the operation non-trivial.

Merge operation allows to construct more interesting invariants from the products of Yangian invariants. One begins from a product of Yangian invariants (Yangian invariant trivially) represented cyclically as points of circle and identifies the last twistor argument of given invariant with the first twistor argument of the next invariant and performs integrals over the momentum twistor variables

appearing twice. The soft  $k$ -increasing and preserving operations can be described also in terms of this operation for Yangian invariants such that the second invariant corresponds to 3-vertex. The cyclic merge operation applied to four MHV amplitudes gives NMHV amplitudes associated with on mass shell momenta in box diagrams. By applying similar operation to NMHV amplitudes and MHV amplitudes one obtains 2-loop amplitudes. In [?] examples about these operations are described.

### BCFW bridge

BCFW bridge allows to build general tree diagrams from MHV tree diagrams [?, ?] and recursion formula of [?] generalizes this to arbitrary diagrams. At the level of Feynman diagrams it corresponds to a box diagram containing general diagrams labeled by  $L$  and  $R$  and MHV and  $\overline{MHV}$  3-vertices ( $\overline{MHV}$  3-vertex allows expression in terms of MHV diagrams) with the lines of the box on mass shell so that the three momenta emanating from the vertices are parallel and give rise to a one-loop leading singularity.

At the level of Feynman diagrams BCFW bridge corresponds to so called "two-mass hard" leading singularities associated with box diagrams with light-like momenta at the four lines of the diagram [?]. The motivation for the study of these diagrams comes from the hypothesis the leading order singularities obtained by putting as many particles as possible on mass shell contain the data needed to construct scattering amplitudes of  $\mathcal{N} = 4$  SYM completely. This representation of the leading singularities generalizes to arbitrary loops. The recent article is a continuation of this program to planar amplitudes.

Also BCFW bridge allows an interpretation as a particular kind fusion for Yang invariants and involves all the basic operations. One starts from the amplitudes  $Y_{n_L, k_L}^L$  and  $Y_{n_R, k_R}^R$  and constructs an amplitude  $Y'_{n_L+n_R, k_L+k_R+1}$  representing the amplitude which would correspond to a generalization of the MHV diagrams with the two tree diagrams connected by the MHV propagator (BCFW bridge) replaced with arbitrary loop diagrams. Particle "1" *resp.* "j+1" is added by the soft  $k$ -increasing factor to  $Y_{n_L+1, k_L+1}$  *resp.*  $Y_{n_R+1, k_R+1}$  giving amplitude with  $n+2$  particles and with  $k$ -charge equal to  $k_L+k_R+2$ . The subsequent operations must reduce  $k$ -charge by one unit. First repeated "1" and "j+1" are identified with their copies by  $k$  conserving merge operation, and after that one performs an integral over the twistor variable  $Z^I$  associated with the internal line obtained and reducing  $k$  by one unit. The soft  $k$ -increasing factors bring in the invariants  $[n-1 \ n \ 1 \ I \ j+2]$  associated with  $Y_L$  and  $[1 \ I \ j+1 \ j \ j-1]$  associated with  $Y_R$ . The integration contour is chosen so that it selects the pole defined by  $\langle n-1 \ n \ 1 \ I \rangle$  in the denominator of  $[n-1 \ n \ 1 \ I \ j+2]$  and the pole defined by  $\langle 1 \ I \ j+1 \ j \rangle$  in the denominator of  $[1 \ I \ j+1 \ j \ j-1]$ .

The explicit expression for the BCFW bridge is very simple:

$$\begin{aligned} (Y_L \otimes_{BFCW} Y_R)(1, \dots, n) &= [n-1 \ n \ 1 \ j \ j+1] \times Y_R(1, \dots, j, I) Y_L(I, j+1, \dots, n-1, \hat{n}) , \\ \hat{n} &= (n-1 \ n) \cap (j \ j+1 \ 1) , \quad I = (j \ j+1) \cap (n-1 \ n \ 1) . \end{aligned} \quad (9.3.36)$$

### Single cuts and forward limit

Forward limit operation is used to increase the number of loops by one unit. The physical picture is that one starts from say 1-loop amplitude and cuts one line by assigning to the pieces of the line opposite light-like momenta having interpretation as incoming and outgoing particles. The resulting amplitude is called forward limit. The only reasonable interpretation seems to be that the loop integration is expressed by unitarity as forward limit meaning cutting of the line carrying the loop momentum. This operation can be expressed in a manifestly Yangian invariant way as entangled removal of two particles with the merge operation meaning the replacement  $Z_n \rightarrow Z_{n-1}$ . Particle  $n+1$  is added adjacent to  $A, B$  as a  $k$ -increasing inverse soft factor and then  $A$  and  $B$  are removed by entangled integration, and after this merge operation identifies  $n+1$  and 1.

Forward limit is crucial for the existence of loops and for Yangian invariants it corresponds to the poles arising from  $\langle (AB)_q Z_n(z) Z_1 \rangle$  the integration contour  $Z_n + z Z_{n-1}$  around  $Z_b$  in the basic formula  $M = \oint (dz/z) M_n$  leading to the recursion formula.  $A$  and  $B$  denote the momentum twistors associated with opposite light-like momenta. In the generalized unitarity conditions the singularity corresponds to the cutting of line between particles  $n$  and 1 with momenta  $q$  and  $-q$ , summing over the multiplet of stats running around the loop. Between particles  $n_2$  and 1 one has particles  $n-1, n$

with momenta  $q, -q$ .  $q = x_1 - x_n = -x_n + x_{n-1}$  giving  $x_1 = x_{n-1}$ . Light-likeness of  $q$  means that the lines (71) = (76) and (15) intersect. At the forward limit giving rise to the pole  $Z_6$  and  $Z_7$  approach to the intersection point (76)  $\cap$  (15) . In a generic gauge theories the forward limits are ill-defined but in super-symmetric gauge theories situation changes.

The corresponding Yangian operation removes two external particles with opposite four-momenta and involves integration over two twistor variables  $Z_a$  and  $Z_b$  and gives rise to the following expression

$$\int_{GL(2)} Y(\dots, Z_n, Z_A, Z_B, Z_1, \dots) . \tag{9.3.37}$$

The integration over  $GL(2)$  corresponds to integration over twistor variables associated  $Z_A$  and  $Z_B$ . This operation allows addition of a loop to a given amplitude. The line  $Z_a Z_b$  represents loop momentum on one hand and the dual  $x$ -coordinate identified as momentum propagating along the line on the other hand.

The integration over these variables is equivalent to an integration over loop momentum as the explicit calculation of [?] (see pages 12-13) demonstrates. If the integration contours are products in the product of twistor spaces associated with  $a$  and  $b$  the and gives lower order Yangian invariant as answer. It is however also possible to choose the integration contour to be entangled in the sense that it cannot be reduced to a product of integration contours in the Cartesian product of twistor spaces. In this case the integration gives a loop integral. In the removal operation Yangian invariance can be broken by IR singularities associated with the integration contour and the procedure does not produce genuine Yangian invariant always.

What is highly interesting from TGD point of view is that this integral can be expressed as a contour integral over  $CP_1 \times CP_1$  combined with integral over loop momentum. If TGD vision about generalized Feynman graphs in zero energy ontology is correct, the loop momentum integral is discretized to an an integral over discrete mass shells and perhaps also to a sum over discretized momenta and one can therefore avoid IR singularities.

### 9.3.6 Explicit formula for the recursion relation

Recall that the recursion formula is obtained by considering super-symmetric momentum-twistor deformation  $Z_n \rightarrow Z_n + zZ_{n-1}$  and by integrating over  $z$  to get the identity

$$M_{n,k,l} = \oint \frac{dz}{z} \hat{M}_{n,k,l}(z) . \tag{9.3.38}$$

This integral equals to integral with reversed integration contour enclosing the exterior of the contour. The challenge is to deduce the residues contributing to the residue integral and the claim of [?] is that these residues reduce to simple basic types.

1. The first residue corresponds to a pole at infinity and reduces the particle number by one giving a contribution  $M_{n-1,k,l}(1, \dots, n-1)$  to  $M_{n,k,l}(1, \dots, n-1, n)$ . This is not totally trivial since the twistor variables are related to momenta in different manner for the two amplitudes. This gives the first contribution to the right hand side of the formula below.
2. Second pole corresponds to the vanishing of  $\langle Z_n(z) Z_1 Z_j Z_{j+1} \rangle$  and corresponds to the factorization of channels. This gives the second BCFW contribution to the right hand side of the formula below. These terms are however not enough since the recursion formula would imply the reduction to expressions involving only loop corrections to 3-loop vertex which vanish in  $\mathcal{N} = 4$  SYM.
3. The third kind of pole results when  $\langle (AB)_q Z_n(z) Z_1 \rangle$  vanishes in momentum twistor space.  $(AB)_q$  denotes the line in momentum twistor space associated with  $q$ :th loop variable.

The explicit formula for the recursion relation yielding planar all loop amplitudes is obtained by putting all these pieces together and reads as

$$\begin{aligned}
M_{n,k,l}(1, \dots, n) &= M_{n-1,k,l}(1, \dots, n-1) \\
&+ \sum_{n_L, k_L, l_L; j} [j \ j+1 \ n-1 \ n \ 1] M_{n_R, k_R, l_R}^R(1, \dots, j, I_j) \times M_{n_L, k_L, l_L}^L(I_j, j+1, \dots, \hat{n}_j) \\
&+ \int_{GL(2)} [AB \ n-1 \ n \ 1] M_{n+2, k+1, n, k-1}(1, \dots, \hat{n}_{AB}, \hat{A}, B) \ , \\
n_L &+ n_R = n+2 \ , \quad k_L + k_R = k-1 \ , \quad l_R + l_L = l \ .
\end{aligned} \tag{9.3.39}$$

The momentum super-twistors are given by

$$\begin{aligned}
\hat{n}_j &= (n-1 \ n) \cap (j \ j+1 \ 1) \ , \quad I_j = (j \ j+1 \ 1) \cap (n-1 \ n \ 1) \ , \\
\hat{n}_{AB} &= (n-1 \ n) \cap (AB \ 1) \ , \quad \hat{A} = (AB) \cap (n-1 \ n \ 1) \ .
\end{aligned} \tag{9.3.40}$$

The index  $l$  labels loops in  $n+2$ -particle amplitude and the expression is fully symmetrized with equal weight for all loop integration variables  $(AB)_l$ .  $A$  and  $B$  are removed by entangled integration meaning that  $GL(2)$  contour is chosen to encircle points where both points  $A, B$  on the line  $(AB)$  are located at the intersection of the line  $(AB)$  with the plane  $(n-1 \ n \ 1)$ .  $GL(2)$  integral can be done purely algebraically in terms of residues.

In [?] and [?] explicit calculations for  $N^k MHV$  amplitudes are carried out to make the formulas more concrete. For  $N^1 MHV$  amplitudes second line of the formula vanishes and the integrals are rather simple since the determinants are  $1 \times 1$  determinants.

## 9.4 Could the Grassmannian program be realized in TGD framework?

In the following the TGD based modification of the approach based on zero energy ontology is discussed in some detail. It is found that pseudo-momenta are very much analogous to region momenta and the approach leading to discretization of pseudo-mass squared for virtual particles - and even the discretization of pseudo-momenta - is consistent with the Grassmannian approach in the simple case considered and allow to get rid of IR divergences. Also the possibility that the number of generalized Feynman diagrams contributing to a given scattering amplitude is finite so that the recursion formula for the scattering amplitudes would involve only a finite number of steps (maximum number of loops) is considered. One especially promising feature of the residue integral approach with discretized pseudo-momenta is that it makes sense also in the p-adic context in the simple special case discussed since residue integral reduces to momentum integral (summation) and lower-dimensional residue integral.

### 9.4.1 What Yangian symmetry could mean in TGD framework?

The loss of the Yangian symmetry in the integrations over the region momenta  $x^a$  ( $p^a = x^{a+1} - x^a$ ) assigned to virtual momenta seems to be responsible for many ugly features. It is basically the source of IR divergences regulated by "moving out on the Coulomb branch theory" so that IR singularities remain the problem of the theory. This raises the question whether the loss of Yangian symmetry is the signature for the failure of QFT approach and whether the restriction of loop momentum integrations to avoid both kind of divergences might be a royal road beyond QFT. In TGD framework zero energy ontology indeed leads to a concrete proposal based on the vision that virtual particles are something genuinely real.

The detailed picture is of course far from clear but to get an idea about what is involved one can look what kind of assumptions are needed if one wants to realize the dream that only a finite number of generalized Feynman diagrams contribute to a scattering amplitude which is Yangian invariant allowing a description using a generalization of the Grassmannian integrals.

1. Assume the bosonic emergence and its super-symmetric generalization holds true. This means that incoming and outgoing states are bound states of massless fermions assignable to wormhole



throats but the fermions can opposite directions of three-momenta making them massive. Incoming and outgoing particles would consist of fermions associated with wormhole throats and would be characterized by a pair of twistors in the general situation and in general massive. This allows also string like mass squared spectrum for bound states having fermion and antifermion at the ends of the string as well as more general  $n$ -particle bound states. Hence one can speak also about the emergence of string like objects. For virtual particles the fermions would be massive and have discrete mass spectrum. Also super partners containing several collinear fermions and antifermions at a given throat are possible. Collinearity is required by the generalization of SUSY. The construction of these states bring strongly in mind the merge procedure involving the replacement  $Z^{n+1} \rightarrow Z^n$ .

2. The basic question is how the momentum twistor diagrams and the ordinary Feynman diagrams behind them are related to the generalized Feynman diagrams.
  - (a) It is good to start from a common problem. In momentum twistor approach the relationship of region momenta to physical momenta remains somewhat mysterious. In TGD framework in turn the relationship of pseudo-momenta identified as generalized eigenvalues of the Chern-Simons Dirac operator at the lines of Feynman diagram (light-like wormhole throats) to the physical momenta has remained unclear. The identification of the pseudo-momentum as the TGD counterpart of the region momentum  $x$  looks therefore like a natural first guess.
  - (b) The identification  $x_{a+1} - x_a = p_a$  with  $p_a$  representing light-like physical four-momentum generalizes in obvious manner. Also the identification of the light-like momentum of the external parton as pseudo-momentum looks natural. What is important is that this does not require the identification of the pseudo-momenta propagating along internal lines of generalized Feynman diagram as actual physical momenta since pseudo-momentum just like  $x$  is fixed only apart from an overall shift. The identification allows the physical four-momenta associated with the wormhole throats to be always on mass shell and massless: if the sign of the physical energy can be also negative space-like momentum exchanges become possible.
  - (c) The pseudo-momenta and light-like physical massless momenta at the lines of generalized Feynman diagrams on one hand, and region momenta and the light-like momenta associated with the collinear singularities on the other hand would be in very similar mutual relationship. Partonic 2-surfaces can carry large number of collinear light-like fermions and bosons since super-symmetry is extended. Generalized Feynman diagrams would be analogous to momentum twistor diagrams if this picture is correct and one could hope that the recursion relations of the momentum twistor approach generalize.
3. The discrete mass spectrum for pseudo-momentum would in the momentum twistor approach mean the restriction of  $x$  to discrete mass shells, and the obvious reason for worry is that this might spoil the Grassmannian approach relying heavily on residue integrals and making sense also  $p$ -adically. It seems however that there is no need to worry. In [?] the  $M_{6,4,l=0}(1234AB)$  the integration over twistor variables  $z_A$  and  $z_B$  using "entangled" integration contour leads to 1-loop MHV amplitude  $N^p MHV$ ,  $p = 1$ . The parametrization of the integration contour is  $z_A = (\lambda_A, x\lambda_A)$ ,  $z_B = (\lambda_B, x\lambda_B)$ , where  $x$  is the  $M^4$  coordinate representing the loop momentum. This boils down to an integral over  $CP_1 \times CP_1 \times M^4$  [?]. The integrals over spheres  $CP_1$ s are contour integrals so that only an ordinary integral over  $M^4$  remains. The reduction to this kind of sums occurs completely generally thanks to the recursion formula.
4. The obvious implication of the restriction of the pseudo-momenta  $x$  on massive mass shells is the absence of IR divergences and one might hope that under suitable assumptions one achieves Yangian invariance. The first question is of course whether the required restriction of  $x$  to mass shells in  $z_A$  and  $z_B$  or possibly even algebraic discretization of momenta is consistent with the Yangian invariance. This seems to be the case: the integration contour reduces to entangled integration contour in  $CP_1 \times CP_1$  not affected by the discretization and the resulting loop integral differs from the standard one by the discretization of masses and possibly also momenta with massless states excluded. Whether Yangian invariance poses also conditions on mass and momentum spectrum is an interesting question.

5. One can consider also the possibility that the incoming and outgoing particles - in general massive and to be distinguished from massless fermions appearing as their building blocks- have actually small masses presumably related to the IR cutoff defined by the size scale of the largest causal diamond involved. p-Adic thermodynamics could be responsible for this mass. Also the binding of the wormhole throats can give rise to a small contribution to vacuum conformal weight possibly responsible for gauge boson masses. This would imply that a given n-particle state can decay to N-particle states for which  $N$  is below some limit. The fermions inside loops would be also massive. This allows to circumvent the IR singularities due to integration over the phase space of the final states (say in Coulomb scattering).
6. The representation of the off mass shell particles as pairs of wormhole throats with non-parallel four-momenta (in the simplest case only the three-momenta need be in opposite directions) makes sense and that the particles in question are on mass shell with mass squared being proportional to inverse of a prime number as the number theoretic vision applied to the modified Dirac equation suggests. On mass shell property poses extremely powerful constraints on loops and when the number of the incoming momenta in the loop increases, the number of constraints becomes larger than the number of components of loop momentum for the generic values of the external momenta. Therefore there are excellent hopes of getting rid of UV divergences.

A stronger assumption encouraged by the classical space-time picture about virtual particles is that the 3-momenta associated with throats of the same wormhole contact are always in same or opposite directions. Even this allows to have virtual momentum spectrum and non-trivial mass spectrum for them assuming that the three momenta are opposite.

7. The best that one can hope is that only a finite number of generalized Feynman diagrams contributes to a given reaction. This would guarantee that amplitudes belong to a finite-dimensional algebraic extension of rational functions with rational coefficients since finite sums do not lead out from a finite algebraic extension of rationals. The first problem are self energy corrections. The assumption that the mass non-renormalization theorems of SUSYs generalize to TGD framework would guarantee that the loops contributing to fermionic propagators (and their super-counterparts) do not affect them. Also the iteration of more complex amplitudes as analogs of ladder diagrams representing sequences of reactions  $M \rightarrow M_1 \rightarrow M_2 \cdots \rightarrow N$  such that at each  $M_n$  in the sequence can appear as on mass shell state could give a non-vanishing contribution to the scattering amplitude and would mean infinite number of Feynman diagrams unless these amplitudes vanish. If  $N$  appears as a virtual state the fermions must be however massive on mass shell fermions by the assumption about on-mass shell states and one can indeed imagine a situation in which the decay  $M \rightarrow N$  is possible when  $N$  consists of states made of massless fermions is possible but not when the fermions have non-vanishing masses. This situation seems to be consistent with unitarity. The implication would be that the recursion formula for the all loop amplitudes for a given reaction would give vanishing result for some critical value of loops.

Already these assumptions give good hopes about a generalization of the momentum Grassmann approach to TGD framework. Twistors are doubled as are also the Grassmann variables and there are wave functions correlating the momenta of the the fermions associated with the opposite wormhole throats of the virtual particles as well as incoming gauge bosons which have suffered massivation. Also wave functions correlating the massless momenta at the ends of string like objects and more general many parton states are involved but do not affect the basic twistor formalism. The basic question is whether the hypothesis of unbroken Yangian symmetry could in fact imply something resembling this picture. The possibility to discretize integration contours without losing the representation as residue integral quite generally is basic prerequisite for this and should be shown to be true.

#### 9.4.2 How to achieve Yangian invariance without trivial scattering amplitudes?

In  $\mathcal{N} = 4$  SYM the Yangian invariance implies that the MHV amplitudes are constant as demonstrated in [?]. This would mean that the loop contributions to the scattering amplitudes are trivial. Therefore the breaking of the dual super-conformal invariance by IR singularities of the integrand is absolutely essential for the non-triviality of the theory. Could the situation be different in TGD framework?

Could it be possible to have non-trivial scattering amplitudes which are Yangian invariants. Maybe! The following heuristic argument is formulated in the language of super-twistors.

1. The dual conformal super generators of the super-Lie algebra  $U(2, 2)$  acting as super vector fields reducing effectively to the general form  $J = \eta_a^K \partial / \partial Z_a^J$  and the condition that they annihilate scattering amplitudes implies that they are constant as functions of twistor variables. When particles are replaced with pairs of wormhole throats the super generators are replaced by sums  $J_1 + J_2$  of these generators for the two wormhole throats and it might be possible to achieve the condition

$$(J_1 + J_2)M = 0 \quad (9.4.1)$$

with a non-trivial dependence on the momenta if the super-components of the twistors associated with the wormhole throats are in a linear relationship. This should be the case for bound states.

2. This kind of condition indeed exists. The condition that the sum of the super-momenta expressed in terms of super-spinors  $\lambda$  reduces to the sum of real momenta alone is not usually posed but in the recent case it makes sense as an additional condition to the super-components of the the spinors  $\lambda$  associated with the bound state. This quadratic condition is exactly of the same general form as the one following from the requirement that the sum of all external momenta vanishes for scattering amplitude and reads as

$$X = \lambda_1 \eta_1 + \lambda_2 \eta_2 = 0 \quad (9.4.2)$$

The action of the generators  $\eta_1 \partial_{\lambda_1} + \eta_2 \partial_{\lambda_2}$  forming basic building blocks of the super generators on  $p_1 + p_2 = \lambda_1 \lambda_1 + \lambda_2 \lambda_2$  appearing as argument in the scattering amplitude in the case of bound states gives just the quantity  $X$ , which vanishes so that one has super-symmetry. The generalization of this condition to n-parton bound state is obvious.

3. The argument does not apply to free fermions which have not suffered topological condensation and are therefore represented by  $CP_2$  type vacuum extremal with single wormhole throat. If one accepts the weak form of electric-magnetic duality, one can circumvent this difficulty. The free fermions carry Kähler magnetic charge whereas physical fermions are accompanied by a bosonic wormhole throat carrying opposite Kähler magnetic charge and opposite electroweak isospin so that a ground state of string like object with size of order electroweak length scale is in question. In the case of quarks the Kähler magnetic charges need not be opposite since color confinement could involve Kähler magnetic confinement: electro-weak confinement holds however true also now. The above argument generalizes as such to the pairs formed by wormhole throats at the ends of string like object. One can of course imagine also more complex hybrids of these basic options but the general idea remains the same.

Note that the argument involves in an essential manner non-locality, which is indeed the defining property of the Yangian algebra and also the fact that physical particles are bound states. The massivation of the physical particles brings in the IR cutoff.

### 9.4.3 Number theoretical constraints on the pseudo-momenta

One can consider also further assumptions motivated by the recent view about the generalized eigenvalues of Chern-Simons Dirac operator having interpretation as pseudo-momentum. The details of this view need not of course be final.

1. Assume that the pseudo-momentum assigned to fermion lines by the modified Dirac equation [?] is the counterpart of region momentum as already explained and therefore does not directly correspond to the actual light-like four-momentum associated with partonic line of the generalized Feynman diagram. This assumption conforms with the assumption that incoming particles are built out of massless partonic fermions. It also implies that the propagators are massless propagators as required by twistorialization and Yangian generalization of super-conformal invariance.

2. Since (pseudo)-mass squared is number theoretically quantized as the length of a hyper-complex prime in preferred plane  $M^2$  of pseudo-momentum space fermionic propagators are massless propagators with pseudo-masses restricted on discrete mass shells. Lorentz invariance suggests that  $M^2$  cannot be common to all particles but corresponds to preferred reference frame for the virtual particle having interpretation as plane spanned by the quantization axes of energy and spin.
3. Hyper-complex primeness means also the quantization of pseudo-momentum components so that one has hyper-complex primes of form  $\pm((p+1)/2, \pm(p-1)/1)$  corresponding to pseudo-mass squared  $M^2 = p$  and hypercomplex primes  $\pm(p, 0)$  with pseudo-mass squared  $M^2 = p^2$ . Space-like fermionic momenta are not needed since for opposite signs of energy wormhole throats can have space-like net momenta. If space-like pseudo-momenta are allowed/needed for some reason, they could correspond to space-like hyper-complex primes  $\pm((p-1)/2, \pm(p+1)/1)$  and  $\pm(0, p)$  so that one would obtain also discretization of space-like mass shells also. The number theoretical mass squared is proportional to  $p$ , whereas p-adic mass squared is proportional to  $1/p$ . For p-adic mass calculations canonical identification  $\sum x_n p^n$  maps p-adic mass squared to its real counterpart. The simplest mapping consistent with this would be  $(p_0, p_1) \rightarrow (p_0, p_1)/p$ . This could be assumed from the beginning in real context and would mean that the mass squared scale is proportional to  $1/p$ .
4. Lorentz invariance requires that the preferred coordinate system in which this holds must be analogous to the rest system of the virtual fermion and thus depends on the virtual particle. In accordance with the general vision discussed in [?] Lorentz invariance could correspond to a discrete algebraic subgroup of Lorentz group spanned by transformation matrices expressible in terms of roots of unity. This would give a discrete version of mass shell and the preferred coordinate system would have a precise meaning also in the real context. Unless one allows algebraic extension of p-adic numbers p-adic mass shell reduces to the set of above number-theoretic momenta. For algebraic extensions of p-adic numbers the same algebraic mass shell is obtained as in real correspondence and is essential for the number theoretic universality. The interpretation for the algebraic discretization would be in terms of a finite measurement resolution. In real context this would mean discretization inducing a decomposition of the mass shell to cells. In the p-adic context each discrete point would be replaced with a p-adic continuum. As far as loop integrals are considered, this vision means that they make sense in both real and p-adic context and reduce to summations in p-adic context. This picture is discussed in detail in [?] .
5. Concerning p-adicization the beautiful aspect of residue integral is that it makes sense also in p-adic context provided one can circumvent the problems related to the identification of p-adic counterpart of  $\pi$  requiring infinite-dimensional transcendental extension coming in powers of  $\pi$ . Together with the discretization of both real and virtual four-momenta this would allow to define also p-adic variants of the scattering amplitudes.

#### 9.4.4 Could recursion formula allow interpretation in terms of zero energy ontology?

The identification of pseudo-momentum as a counterpart of region momentum suggests that generalized Feynman diagrams could be seen as a generalization of momentum twistor diagrams. Of course, the generalization from  $\mathcal{N} = 4$  SYM to TGD is an enormous step in complexity and one must take all proposals in the following with a big grain of salt. For instance, the replacement of point-like particles with wormhole throats and the decomposition of gauge bosons to pairs of wormhole throats means that naive generalizations are dangerous.

With this in firmly in mind one can ask whether the recursion formula could allow interpretation in terms of zero energy states assigned to causal diamonds (*CDs*) containing *CDs* containing  $\dots$ . In this framework loops could be assigned with sub-*CDs*.

The interpretation of the leading order singularities forming the basic building blocks of the twistor approach in zero ontology is the basic source of questions. Before posing these questions recall the basic proposal that partonic fermions are massless but opposite signs of energy are possible for the opposite throats of wormhole contacts. Partons would be on mass shell but besides physical states

identified as bound states formed from partons also more general intermediate states would be possible but restricted by momentum conservation and mass shell conditions for partons at vertices. Consider now the questions.

1. Suppose that the massivation of virtual fermions and their super partners allows only ladder diagrams in which the intermediate states contain on mass shell massless states. Should one allow this kind of ladder diagrams? Can one identify them in terms of leading order singularities? Could one construct the generalized Feynman diagrams from Yangian invariant tree diagrams associated with the hierarchy of sub- $CD$ s and using BCFW bridges and entangled pairs of massless states having interpretation as box diagrams with on mass shell momenta at microscopic level? Could it make sense to say that scattering amplitudes are represented by tree diagrams inside  $CD$ s in various scales and that the fermionic momenta associated with throats and emerging from sub- $CD$ s are always massless?
2. Could BCFW bridge generalizes as such and could the interpretation of BCFW bridge be in terms of a scattering in which the four on mass shell massless partonic states (partonic throats have arbitrary fermion number) are exchanged between four sub- $CD$ s. This admittedly looks somewhat artificial.
3. Could the addition of 2-particle zero energy state responsible for addition of loop in the recursion relations and having interpretation in terms of the cutting of line carrying loop momentum correspond to an addition of sub- $CD$  such that the 2-particle zero energy state has its positive and negative energy part on its past and future boundaries? Could this mean that one cuts a propagator line by adding  $CD$  and leaves only the portion of the line within  $CD$ . Could the reverse operation mean to the addition of zero energy "thermally entangled" states in shorter time and length scales and assignable as a zero energy state to a sub- $CD$ . Could one interpret the Cutkosky rule for propagator line in terms of this cutting or its reversal. Why only pairs would be needed in the recursion formula? Why not more general states? Does the recursion formula imply that they are included? Does this relate to the fact that these zero energy states have interpretation as single particle states in the positive energy ontology and that the basic building block of Feynman diagrams is single particle state? Could one regard the unitarity as an identity which states that the discontinuity of T-matrix characterizing zero energy state over cut is expressible in terms of  $TT^\dagger$  and  $T$  matrix is the relevant quantity?

Maybe it is again dangerous to try to draw too detailed correspondences: after all, point like particles are replaced by partonic two-surfaces in TGD framework.

4. If I have understood correctly the genuine  $l$ -loop term results from  $l - 1$ -loop term by the addition of the zero energy pair and integration over  $GL(2)$  as a representative of loop integral reducing  $n + 2$  to  $n$  and calculating the added loop at the same time [?]. The integrations over the two momentum twistor variables associated with a line in twistor space defining off mass shell four-momentum and integration over the lines represent the integration over loop momentum. The reduction to  $GL(2)$  integration should result from the delta functions relating the additional momenta to  $GL(2)$  variables (note that  $GL(2)$  performs linear transformations in the space spanned by the twistors  $Z_A$  and  $Z_B$  and means integral over the positions of  $Z_A$  and  $Z_B$ ). The resulting object is formally Yangian invariant but IR divergences along some contours of integration breaks Yangian symmetry.

The question is what happens in TGD framework. The previous arguments suggests that the reduction of the the loop momentum integral to integrals over discrete mass shells and possibly to a sum over their discrete subsets does not spoil the reduction to contour integrals for loop integrals in the example considered in [?]. Furthermore, the replacement of mass continuum with a discrete set of mass shells should eliminate IR divergences and might allow to preserve Yangian symmetry. One can however wonder whether the loop corrections with on mass shell massless fermions are needed. If so, one would have at most finite number of loop diagrams with on mass shell fermionic momenta and one of the TGD inspired dreams already forgotten would be realized.

### 9.4.5 What about unitarity?

The approach of Arkani-Hamed and collaborators means that loop integral over four-momenta are replaced with residue integrals around a small sphere  $p^2 = \epsilon$ . This is very much reminiscent of my own proposal for a few years ago based on the idea that the condition of twistorialization forces to accept only massless virtual states [?, ?]. I of course soon gave up this proposal as too childish.

This idea seems to however make a comeback in a modified form. At this time one would have only massive and quantized pseudo-momenta located at discrete mass shells. Can this picture be consistent with unitarity?

Before trying to answer this question one must make clear what one could assume in TGD framework.

1. Physical particles are in the general case massive and consist of collinear fermions at wormhole throats. External partons at wormhole throats must be massless to allow twistorial interpretation. Therefore massive states emerge. This applies also to stringy states.
2. The simplest assumption generalizing the childish idea is that on mass shell massless states for partons appear as both virtual particles and external particles. Space-like virtual momentum exchanges are possible if the virtual particles can consist of pairs of positive and negative energy fermions at opposite wormhole throats. Hence also partons at internal lines should be massless and this raises the question about the identification of propagators.
3. Generalized eigenvalue equation for Chern-Simons Dirac operator implies that virtual elementary fermions have massive and quantized pseudo-momenta whereas external elementary fermions are massless. The massive pseudo-momentum assigned with the Dirac propagator of a parton line cannot be identified with the massless real momentum assigned with the fermionic propagator line. The region momenta introduced in Grassmannian approach are something analogous.

As already explained, this brings in mind is the identification of this pseudo momentum as the counterpart of the region momentum of momentum twistor diagrams so that the external massless fermionic momenta would be differences of the pseudo-momenta. Indeed, since region momenta are determined apart from a common shift, they need not correspond to real momenta. Same applies to pseudo-momenta and one could assume that both internal and external fermion lines carry light-like pseudo-momenta and that external pseudo-momenta are equal to real momenta.

4. This picture has natural correspondence with twistor diagrams. For instance, the region momentum appearing in BCFW bridge defining effective propagator is in general massive although the underlying Feynman diagram would contain online massless momenta. In TGD framework massless lines of Feynman graphs associated with singularities would correspond to real momenta of massless fermions at wormhole throats. Also other canonical operations for Yangian invariants involve light-like momenta at the level of Feynman diagrams and would in TGD framework have a natural identification in terms of partonic momenta. Hence partonic picture would provide a microscopic description for the lines of twistor diagrams.

Let us assume being virtual particle means only that the discretized pseudo-momentum is on shell but massive whereas all real momenta of partons are light-like, and that negative partonic energies are possible. Can one formulate Cutkosky rules for unitarity in this framework? What could the unitarity condition

$$iDisc(T - T^\dagger) = -TT^\dagger$$

mean now? In particular, are the cuts associated with mass shells of physical particles or with mass shells of pseudo-momenta? Could these two assignments be equivalent?

1. The restriction of the partons to be massless but having both signs of energy means that the spectrum of intermediate states contains more states than the external states identified as bound states of partons with the same sign of energy. Therefore the summation over intermediate states does not reduce to a mere summation over physical states but involves a summation over states formed from massless partons with both signs of energy so that also space-like momentum exchanges become possible.

2. The understanding of the unitarity conditions in terms of Cutkosky rules would require that the cuts of the loop integrands correspond to mass shells for the virtual states which are also physical states. Therefore real momenta have a definite sign and should be massless. Besides this bound state conditions guaranteeing that the mass spectrum for physical states is discrete must be assumed. With these assumptions the unitary cuts would not be assigned with the partonic light-cones but with the mass shells associated of physical particles.
3. There is however a problem. The pseudo-momenta of partons associated with the external partons are assumed to be light-like and equal to the physical momenta.
  - (a) If this holds true also for the intermediate physical states appearing in the unitarity conditions, the pseudo-momenta at the cuts are light-like and cuts must be assigned with pseudo-momentum light-cones. This could bring in IR singularities and spoil Yangian symmetry. The formation of bound states could eliminate them and the size scale of the largest  $CD$  involved would bring in a natural IR cutoff as the mass scale of the lightest particle. This assumption would however force to give up the assumption that only massive pseudo-momenta appear at the lines of the generalized Feynman diagrams.
  - (b) On the other hand, if pseudo-momenta are not regarded as a property of physical state and are thus allowed to be massive for the real intermediate states in Cutkosky rules, the cuts at parton level correspond to on mass shell hyperboloids and IR divergences are absent.

## 9.5 Could TGD allow formulation in terms of twistors

There are many questions to be asked. There would be in-numerable questions upwelling from my very incomplete understanding of the technical issues. In the following I restrict only to the questions which relate to the relationship of TGD approach to Witten's twistor string approach [?] and M-theory like frameworks. The arguments lead to an explicit proposal how the preferred extremals of Kähler action could correspond to holomorphic 4-surfaces in  $CP_3 \times CP_3$ . The basic motivation for this proposal comes from the observation that Kähler action is Maxwell action for the induced Kähler form and metric. Hence Penrose's original twistorial representation for the solutions of linear Maxwell's equations could have a generalization to TGD framework.

### 9.5.1 $M^4 \times CP_2$ from twistor approach

The first question which comes to mind relates to the origin of the Grassmannians. Do they have some deeper interpretation in TGD context. In twistor string theory Grassmannians relate to the moduli spaces of holomorphic surfaces defined by string world sheets in twistor space. Could partonic 2-surfaces have analogous interpretation and could one assign Grassmannians to their moduli spaces? If so, one could have rather direct connection with topological QFT defining twistor strings [?] and the almost topological QFT defining TGD. There are some hints to this direction which could be of course seen as figments of a too wild imagination.

1. The geometry of  $CD$  brings strongly in mind Penrose diagram for the conformally compactified Minkowski space [?], which indeed becomes  $CD$  when its points are replaced with spheres. This would suggest the information theoretic idea about interaction between observer and externals as a map in which  $M^4$  is mapped to its conformal compactification represented by  $CD$ . Compactification means that the light-like points at the light-like boundaries of  $CD$  are identified and the physical counterpart for this in TGD framework is conformal invariance along light-rays along the boundaries of  $CD$ . The world of conscious observer for which  $CD$  is identified as a geometric correlate would be conformally compactified  $M^4$  (plus  $CP_2$  or course).
2. Since the points of the conformally compactified  $M^4$  correspond to twistor pairs [?], which are unique only apart from opposite complex scalings, it would be natural to assign twistor space to  $CD$  and represent its points as pairs of twistors. This suggest an interpretation for the basic formulas of Grassmannian approach involving integration over twistors. The incoming and outgoing massless particles could be assigned at point-like limit light-like points at the lower and upper boundaries of  $CD$  and the lifting of the points of the light-cone boundary at

partonic surfaces would give rise to the description in terms of ordinary twistors. The assumption that massless collinear fermions at partonic 2-surfaces are the basic building blocks of physical particles at partonic 2-surfaces defined as many particles states involving several partonic 2-surfaces would lead naturally to momentum twistor description in which massless momenta and described by twistors and virtual momenta in terms of twistor pairs. It is important to notice that in TGD framework string like objects would emerge from these massless fermions.

3. Partonic 2-surfaces are located at the upper and lower light-like boundaries of the causal diamond ( $CD$ ) and carry energies of opposite sign in zero energy ontology. Quite generally, one can assign to the point of the conformally compactified Minkowski space a twistor pair using the standard description. The pair of twistors is determined apart from  $Gl(2)$  rotation. At the light-cone boundary  $M^4$  points are light-like so that the two spinors of the two twistors differ from each other only by a complex scaling and single twistor is enough to characterize the space-time point this degenerate situation. The components of the twistor are related by the well known twistor equation  $\mu^{a'} = -ix^{aa'}\lambda_a$ . One can therefore lift each point of the partonic 2-surface to single twistor determined apart from opposite complex scalings of  $\mu$  and  $\lambda$  so that the lift of the point would be 2-sphere. In the general case one must lift the point of  $CD$  to a twistor pair. The degeneracy of the points is given by  $Gl(2)$  and each point corresponds to a 2-sphere in projective twistor space.
4. The new observation is that one can understand also  $CP_2$  factor in twistor framework. The basic observation about which I learned in [?] (giving also a nice description of basics of twistor geometry) is that a pair  $(X, Y)$  of twistors defines a point of  $CD$  on one hand and complex 2-planes of the dual twistor space -which is nothing but  $CP_2$ - by the equations

$$X_\alpha W^\alpha = 0 \quad , \quad Y_\alpha W^\alpha = 0 \quad .$$

The intersection of these planes is the complex line  $CP_1 = S^2$ . The action of  $G(2)$  on the twistor pair affects the pair of surfaces  $CP_2$  determined by these equations since it transforms the equations to their linear combination but not the the point of conformal  $CD$  resulting as projection of the sphere. Therefore twistor pair defines both a point of  $M^4$  and assigns with it pair of  $CP_2$ :s represented as holomorphic surfaces of the projective dual twistor space. Hence the union over twistor pairs defines  $M^4 \times CP_2$  via this assignment if it is possible to choose "the other"  $CP_2$  in a unique manner for all points of  $M^4$ . The situation is similar to the assignment of a twistor to a point in the Grassmannian diagrams forming closed polygons with light-like edges. In this case one assigns to the the "region momenta" associated with the edge the twistor at the either end of the edge. One possible interpretation is that the two  $CP_2$ :s correspond to the opposite ends of the  $CD$ . My humble hunch is that this observation might be something very deep.

Recall that the assignment of  $CP_2$  to  $M^4$  point works also in another direction.  $M^8 - H$  duality associates with so called hyper-quaternionic 4-surface of  $M^8$  allowing preferred hyper-complex plane at each point 4-surfaces of  $M^4 \times CP_2$ . The basic observation behind this duality is that the hyper-quaternionic planes (copies of  $M^4$ ) with preferred choices of hyper-complex plane  $M^2$  are parameterized by points of  $CP_2$ . One can therefore assign to a point of  $CP_2$  a copy of  $M^4$ . Maybe these both assignments indeed belong to the core of quantum TGD. There is also an interesting analogy with Uncertainty Principle: complete localization in  $M^4$  implies maximal uncertainty of the point in  $CP_2$  and vice versa.

### 9.5.2 Does twistor string theory generalize to TGD?

With this background the key speculative questions seem to be the following ones.

1. Could one relate twistor string theory to TGD framework? Partonic 2-surfaces at the boundaries of  $CD$  are lifted to 4-D sphere bundles in twistor space. Could they serve as a 4-D counterpart for Witten's holomorphic twistor strings assigned to point like particles? Could these surfaces be actually lifts of the holomorphic curves of twistor space replaced with the product  $CP_3 \times CP_2$  4-D sphere bundles? If I have understood correctly, the Grassmannians  $G(n, k)$  can be assigned



to the moduli spaces of these holomorphic curves characterized by the degree of the polynomial expressible in terms of genus, number of negative helicity gluons, and the number of loops for twistor diagram.

Could one interpret  $G(n, k)$  as a moduli space for the  $\delta CD$  projections of  $n$  partonic 2-surfaces to which  $k$  negative helicity gluons and  $n - k$  positive helicity gluons are assigned (or something more complex when one considers more general particle states)? Could quantum numbers be mapped to integer valued algebraic invariants? If so, there would be a correlation between the geometry of the partonic 2-surface and quantum numbers in accordance with quantum classical correspondence.

2. Could one understand light-like orbits of partonic 2-surfaces and space-time surfaces in terms of twistors? To each point of the 2-surface one can assign a 2-sphere in twistor space  $CP_3$  and  $CP_2$  in its dual. These  $CP_2$ s can be identified. One should be able to assign to each sphere  $S^2$  at least one point of corresponding  $CP_2$ s associated with its points in the dual twistor space and identified as single  $CP_2$  union of  $CP_2$ :s in the dual twistor space a point of  $CP_2$  or even several of them. One should be also able to continue this correspondence so that it applies to the light-like orbit of the partonic 2-surface and to the space-time surface defining a preferred extremal of Kähler action. For space-time sheets representable as graph of a map  $M^4 \rightarrow CP_2$  locally one should select from a  $CP_2$  assigned with a particular point of the space-time sheet a unique point of corresponding  $CP_2$  in a manner consistent with field equations. For surfaces with lower dimensional  $M^4$  projection one must assign a continuum of points of  $CP_2$  to a given point of  $M^4$ . What kind equations-could allow to realize this assignment? Holomorphy is strongly favored also by the number theoretic considerations since in this case one has hopes of performing integrals using residue calculus.
  - (a) Could two holomorphic equations in  $CP_3 \times CP_2$  defining 6-D surfaces as sphere bundles over  $M^4 \times CP_2$  characterize the preferred extremals of Kähler action? Could partonic 2-surfaces be obtained by posing an additional holomorphic equation reducing twistors to null twistors and thus projecting to the boundaries of  $CD$ ? A philosophical justification for this conjecture comes from effective 2-dimensionality stating that partonic 2-surfaces plus their 4-D tangent space data code for physics. That the dynamics would reduce to holomorphy would be an extremely beautiful result. Of course this is only an additional item in the list of general conjectures about the classical dynamics for the preferred extremals of Kähler action.
  - (b) One could also work in  $CP_3 \times CP_3$ . The first  $CP_3$  would represent twistors endowed with a metric conformally equivalent to that of  $M^{2,4}$  and having the covering of  $SU(2, 2)$  of  $SO(2, 4)$  as isometries. The second  $CP_3$  defining its dual would have a metric consistent with the Calabi-Yau structure (having holonomy group  $SU(3)$ ). Also the induced metric for canonically imbedded  $CP_2$ s should be the standard metric of  $CP_2$  having  $SU(3)$  as its isometries. In this situation the linear equations assigning to  $M^4$  points twistor pairs and  $CP_2 \subset CP_3$  as a complex plane would hold always true. Besides this two holomorphic equations coding for the dynamics would be needed.
  - (c) The issues related to the induced metric are important. The conformal equivalence class of  $M^4$  metric emerges from the 5-D light-cone of  $M^{2,4}$  under projective identification. The choice of a proper projective gauge would select  $M^4$  metric locally. Twistors inherit the conformal metric with signature  $(2, 4)$  from the metric of 4+4 component spinors with metric having  $(4, 4)$  signature. One should be able to assign a conformal equivalence class of Minkowski metric with the orbits of pairs of twistors modulo  $GL(2)$ . The metric of conformally compactified  $M^4$  would be obtained from this metric by dropping from the line element the contribution to the  $S^2$  fiber associated with  $M^4$  point.
  - (d) Witten related [?] the degree  $d$  of the algebraic curve describing twistor string, its genus  $g$ , the number  $k$  of negative helicity gluons, and the number  $l$  of loops by the following formula

$$d = k - 1 + l \quad , \quad g \leq l \quad . \quad (9.5.1)$$

One should generalize the definition of the genus so that it applies to 6-D surfaces. For projective complex varieties of complex dimension  $n$  this definition indeed makes sense. Algebraic genus [?] is expressible in terms of the dimensions of the spaces of closed holomorphic forms known as Hodge numbers  $h^{p,q}$  as

$$g = \sum (-1)^{n-k} h^{k,0} . \quad (9.5.2)$$

The first guess is that the formula of Witten generalizes by replacing genus with its algebraic counterpart . This requires that the allowed holomorphic surfaces are projective curves of twistor space, that is described in terms of homogenous polynomials of the 4+4 projective coordinates of  $CP_3 \times CP_3$ .

### 9.5.3 What is the relationship of TGD to M-theory and F-theory?

There are also questions relating to the possible relationship to M-theory and F-theory.

1. Calabi-Yau-manifolds [?, ?] are central for the compactification in super string theory and emerge from the condition that the super-symmetry breaks down to  $\mathcal{N} = 1$  SUSY. The dual twistor space  $CP_3$  with Euclidian signature of metric is a Calabi-Yau manifold [?] . Could one have in some sense two Calabi-Yaus! Twistorial  $CP_3$  can be interpreted as a four-fold covering and conformal compactification of  $M^{2,4}$ . I do not know whether Calabi-Yau property has a generalization to the situation when Euclidian metric is replaced with a conformal equivalence class of flat metrics with Minkowskian signature and thus having a vanishing Ricci tensor. As far as differential forms (no dependence on metric) are considered there should be no problems. Whether the replacement of the maximal holonomy group  $SU(3)$  with its non-compact version  $SU(1,2)$  makes sense is not clear to me.
2. The lift of the  $CD$  to projective twistor space would replace  $CD \times CP_2$  with 10-dimensional space which inspires the familiar questions about connection between TGD and M-theory. If Calabi-Yau with a Minkowskian signature of metric makes sense then the Calabi-Yau of the standard M-theory would be replaced with its Minkowskian counterpart! Could it really be that M-theory like theory based on  $CP_3 \times CP_2$  reduces to TGD in  $CD \times CP_2$  if an additional symmetry mapping 2-spheres of  $CP_3$  to points of  $CD$  is assumed? Could the formulation based on 12-D  $CP_3 \times CP_3$  correspond to F-theory which also has two time-like dimensions. Of course, the additional conditions defined by the maps to  $M^4$  and  $CP_2$  would remove the second time-like dimension which is very difficult to justify on purely physical grounds.
3. One can actually challenge the assumption that the first  $CP_3$  should have a conformal metric with signature  $(2,4)$ . Metric appears nowhere in the definition holomorphic functions and once the projections to  $M^4$  and  $CP_2$  are known, the metric of the space-time surface is obtained from the metric of  $M^4 \times CP_2$ . The previous argument for the necessity of the presence of the information about metric in the second order differential equation however suggests that the metric is needed.
4. The beginner might ask whether the 6-D 2-sphere bundles representing space-time sheets could have interpretation as Calabi-Yau manifolds. In fact, the Calabi-Yau manifolds defined as complete intersections in  $CP_3 \times CP_3$  discovered by Tian and Yau are defined by three polynomials [?] . Two of them have degree 3 and depend on the coordinates of single  $CP_3$  only whereas the third is bilinear in the coordinates of the  $CP_3$ :s. Obviously the number of these manifolds is quite too small (taking into account scaling the space defined by the coefficients is 6-dimensional). All these manifolds are deformation equivalent. These manifolds have Euler characteristic  $\chi = \pm 18$  and a non-trivial fundamental group. By dividing this manifold by  $Z_3$  one obtains  $\chi = \pm 6$ , which guarantees that the number of fermion generations is three in heterotic string theory. This manifold was the first one proposed to give rise to three generations and  $\mathcal{N} = 1$  SUSY.

### 9.5.4 What could the field equations be in twistorial formulation?

The fascinating question is whether one can identify the equations determining the 3-D complex surfaces of  $CP_3 \times CP_3$  in turn determining the space-time surfaces.

The first thing is to clarify in detail how space-time  $M^4 \times CP_2$  results from  $CP_3 \times CP_3$ . Each point  $CP_3 \times CP_3$  define a line in third  $CP_3$  having interpretation as a point of conformally compactified  $M^4$  obtained by sphere bundle projection. Each point of either  $CP_3$  in turn defines  $CP_2$  in in fourth  $CP_3$  as a 2-plane. Therefore one has  $(CP_3 \times CP_3) \times (CP_3 \times CP_3)$  but one can reduce the consideration to  $CP_3 \times CP_3$  fixing  $M^4 \times CP_2$ . In the generic situation 6-D surface in 12-D  $CP_3 \times CP_3$  defines 4-D surface in the dual  $CP_3 \times CP_3$  and its sphere bundle projection defines a 4-D surface in  $M^4 \times CP_2$ .

1. The vanishing of three holomorphic functions  $f^i$  would characterize 3-D holomorphic surfaces of 6-D  $CP_3 \times CP_3$ . These are determined by three real functions of three real arguments just like a holomorphic function of single variable is dictated by its values on a one-dimensional curve of complex plane. This conforms with the idea that initial data are given at 3-D surface. Note that either the first or second  $CP_3$  can determine the  $CP_2$  image of the holomorphic 3-surface unless one assumes that the holomorphic functions are symmetric under the exchange of the coordinates of the two  $CP_3$ s. If symmetry is not assumed one has some kind of duality.
2. Effective 2-dimensionality means that 2-D partonic surfaces plus 4-D tangent space data are enough. This suggests that the 2 holomorphic functions determining the dynamics satisfy some second order differential equation with respect to their three complex arguments: the value of the function and its derivative would correspond to the initial values of the imbedding space coordinates and their normal derivatives at partonic 2-surface. Since the effective 2-dimensionality brings in dependence on the induced metric of the space-time surface, this equation should contain information about the induced metric.
3. The no-where vanishing holomorphic 3-form  $\Omega$ , which can be regarded as a "complex square root" of volume form characterizes 6-D Calabi-Yau manifold [?, ?] , indeed contains this information albeit in a rather implicit manner but in spirit with TGD as almost topological QFT philosophy. Both  $CP_3$ s are characterized by this kind of 3-form if Calabi-Yau with (2, 4) signature makes sense.
4. The simplest second order- and one might hope holomorphic- differential equation that one can imagine with these ingredients is of the form

$$\Omega_1^{i_1 j_1 k_1} \Omega_2^{i_2 j_2 k_2} \partial_{i_1 i_2} f^1 \partial_{j_1 j_2} f^2 \partial_{k_1 k_2} f^3 = 0, \quad \partial_{ij} \equiv \partial_i \partial_j. \quad (9.5.3)$$

Since  $\Omega_i$  is by its antisymmetry equal to  $\Omega_i^{123} \epsilon^{ijk}$ , one can divide  $\Omega_i^{123}$ s away from the equation so that one indeed obtains holomorphic solutions. Note also that one can replace ordinary derivatives in the equation with covariant derivatives without any effect so that the equations are general coordinate invariant.

One can consider more complex equations obtained by taking instead of  $(f^1, f^2, f^3)$  arbitrary combinations  $(f^i, f^j, f^k)$  which results uniquely if one assumes anti-symmetrization in the labels (1, 2, 3). In the sequel only this equation is considered.

5. The metric disappears completely from the equations and skeptic could argue that this is inconsistent with the fact that it appears in the equations defining the weak form of electric-magnetic duality as a Lagrange multiplier term in Chern-Simons action. Optimist would respond that the representation of the 6-surfaces as intersections of three hyper-surfaces is different from the representation as imbedding maps  $X^4 \rightarrow H$  used in the usual formulation so that the argument does not bite, and continue by saying that the metric emerges in any case when one endows space-time with the induced metric given by projection to  $M^4$ .
6. These equations allow infinite families of obvious solutions. For instance, when some  $f^i$  depends on the coordinates of either  $CP_3$  only, the equations are identically satisfied. As a special case one obtains solutions for which  $f^1 = Z \cdot W$  and  $(f^2, f^3) = (f^2(Z), f^3(W))$  This family contains also the Calabi-Yau manifold found by Yau and Tian, whose factor space was proposed as the first candidate for a compactification consistent with three fermion families.

- 7. One might hope that an infinite non-obvious solution family could be obtained from the ansatz expressible as products of exponential functions of  $Z$  and  $W$ . Exponentials are not consistent with the assumption that the functions  $f_i$  are homogenous polynomials of finite degree in projective coordinates so that the following argument is only for the purpose for learning something about the basic character of the equations.

$$\begin{aligned}
 f^1 &= E_{a_1, a_2, a_3}(Z) E_{\hat{a}_1, \hat{a}_2, \hat{a}_3}(W) \quad , \quad f^2 = E_{b_1, b_2, b_3}(Z) E_{\hat{b}_1, \hat{b}_2, \hat{b}_3}(W) \quad , \\
 f^3 &= E_{c_1, c_2, c_3}(Z) E_{\hat{c}_1, \hat{c}_2, \hat{c}_3}(W) \quad , \quad (9.5.4) \\
 E_{a,b,c}(Z) &= \exp(az_1) \exp(bz_2) \exp(cz_3) \quad .
 \end{aligned}$$

The parameters  $a, b, c$ , and  $\hat{a}, \hat{b}, \hat{c}$  can be arbitrary real numbers in real context. By the basic properties of exponential functions the field equations are algebraic. The conditions reduce to the vanishing of the products of determinants  $\det(a, b, c)$  and  $\det(\hat{a}, \hat{b}, \hat{c})$  so that the vanishing of either determinant is enough. Therefore the dependence can be arbitrary either in  $Z$  coordinates or in  $W$  coordinates. Linear superposition holds for the modes for which determinant vanishes which means that the vectors  $(a, b, c)$  or  $(\hat{a}, \hat{b}, \hat{c})$  are in the same plane.

Unfortunately, the vanishing conditions reduce to the conditions  $f^i(W) = 0$  for case a) and to  $f^i(Z) = 0$  for case b) so that the conditions are equivalent with those obtained by putting the "wave vector" to zero and the solutions reduce to obvious ones. The lesson is that the equations do not commute with the multiplication of the functions  $f^i$  with nowhere vanishing functions of  $W$  and  $Z$ . The equation selects a particular representation of the surfaces and one might argue that this should not be the case unless the hyper-surfaces defined by  $f^i$  contain some physically relevant information. One could consider the possibility that the vanishing conditions are replaced with conditions  $f^i = c_i$  with  $f^i(0) = 0$  in which case the information would be coded by a family of space-time surfaces obtained by varying  $c_i$ .

One might criticize the above equations since they are formulated directly in the product  $CP_3 \times CP_3$  of projective twistor by choosing a specific projective gauge by putting  $z^4 = 1, w^4 = 1$ . The manifestly projectively invariant formulation for the equations is in full twistor space so that 12-D space would be replaced with 16-D space. In this case one would have 4-D complex permutation symbol giving for these spaces Calabi-Yau structure with flat metric. The product of functions  $f = z^4 = constant$  and  $g = w^4 = constant$  would define the fourth function  $f_4 = fg$  fixing the projective gauge

$$\epsilon^{i_1 j_1 k_1 l_1} \epsilon^{i_2 j_2 k_2 l_2} \partial_{i_1 i_2} f^1 \partial_{j_1 j_2} f^2 \partial_{k_1 k_2} f^3 \partial_{l_1 l_2} f^4 = 0 \quad , \quad \partial_{ij} \equiv \partial_i \partial_j \quad . \quad (9.5.5)$$

The functions  $f^i$  are homogenous polynomials of their twistor arguments to guarantee projective invariance. These equations are projectively invariant and reduce to the above form which means also loss of homogenous polynomial property. The undesirable feature is the loss of manifest projective invariance by the fixing of the projective gauge.

A more attractive ansatz is based on the idea that one must have one equation for each  $f^i$  to minimize the non-determinism of the equations obvious from the fact that there is single equation in 3-D lattice for three dynamical variables. The quartets  $(f^1, f^2, f^3, f^i)$ ,  $i = 1, 2, 3$  would define a possible minimally non-linear generalization of the equation

$$\epsilon^{i_1 j_1 k_1 l_1} \epsilon^{i_2 j_2 k_2 l_2} \partial_{i_1 i_2} f^1 \partial_{j_1 j_2} f^2 \partial_{k_1 k_2} f^m \partial_{l_1 l_2} f^4 = 0 \quad , \quad \partial_{ij} \equiv \partial_i \partial_j \quad , \quad m = 1, 2, 3 \quad . \quad (9.5.6)$$

Note that the functions are homogenous polynomials of their arguments and analogous to spherical harmonics suggesting that they can allow a nice interpretation in terms of quantum classical correspondence.

The minimal non-linearity of the equations also conforms with the non-linearity of the field equations associated with Kähler action. Note that also in this case one can solve the equations by diagonalizing the dynamical coefficient matrix associated with the quadratic term and by identifying the eigen-vectors of zero eigen values. One could consider also more complicated strongly non-linear ansätze such as  $(f^i, f^i, f^i, f^i)$ ,  $i = 1, 2, 3$ , but these do not seem plausible.

**The explicit form of the equations using Taylor series expansion for multi-linear case**

In this section the equations associated with  $(f_1, f_2, f_3)$  ansatz are discussed in order to obtain a perspective about the general structure of the equations by using simpler (multilinearity) albeit probably non-realistic case as starting point. This experience can be applied directly to the  $(f^1, f^2, f^3, f^i)$  ansatz, which is quadratic in  $f^i$ .

The explicit form of the equations is obtained as infinite number of conditions relating the coefficients of the Taylor series of  $f^1$  and  $f^2$ . The treatment of the two variants for the equations is essentially identical and in the following only the manifestly projectively invariant form will be considered.

1. One can express the Taylor series as

$$\begin{aligned}
 f^1(Z, W) &= \sum_{m,n} C_{m,n} M_m(Z) M_n(W) , \\
 f^2(Z, W) &= \sum_{m,n} D_{m,n} M_m(Z) M_n(W) , \\
 f^3(Z, W) &= \sum_{m,n} E_{m,n} M_m(Z) M_n(W) , \\
 M_{m \equiv (m_1, m_2, m_3)}(Z) &= z_1^{m_1} z_2^{m_2} z_3^{m_3} .
 \end{aligned}
 \tag{9.5.7}$$

2. The application of derivatives to the functions reduces to a simple algebraic operation

$$\partial_{ij}(M_m(Z) M_n(W)) = m_i n_j M_{m_1 - e_i}(Z) M_{n - e_j}(W) .
 \tag{9.5.8}$$

Here  $e_i$  denotes  $i$ :th unit vector.

3. Using the product rule  $M_m M_n = M_{m+n}$  one obtains

$$\begin{aligned}
 &\partial_{ij}(M_m(Z) M_n(W)) \partial_{rs}(M_k(Z) M_l(W)) \\
 &= m_i n_j k_r l_s \times M_{m - e_i}(Z) M_{n - e_j}(W) \times M_{k - e_r}(Z) M_{l - e_s}(W) \\
 &= m_i n_j k_r l_s \times M_{m+k - e_i - e_r}(Z) \times M_{n+l - e_j - e_l}(W) .
 \end{aligned}
 \tag{9.5.9}$$

4. The equations reduce to the trilinear form

$$\begin{aligned}
 &\sum_{m,n,k,l,r,s} C_{m,n} D_{k,l} E_{r,s}(m, k, r)(n, l, s) M_{m+k+r-E}(Z) M_{n+l+s-E}(W) = 0 , \\
 E &= e_1 + e_2 + e_3 , \quad (a, b, c) = \epsilon^{ijk} a_i b_j c_c .
 \end{aligned}
 \tag{9.5.10}$$

Here  $(a, b, c)$  denotes the determinant defined by the three index vectors involved. By introducing the summation indices

$$(M = m + k + r - E, k, r) , \quad (N = n + l + s - E, l, s)$$

one obtains an infinite number of conditions, one for each pair  $(M, N)$ . The condition for a given pair  $(M, N)$  reads as

$$\sum_{k,l,r,s} C_{M-k-r+E, N-l-s+E} D_{k,l} E_{r,s} \times (M-k-r+E, k, r)(N-l-s+E, l, s) = 0 . \quad (9.5.11)$$

These equations can be regarded as linear equations by regarding any matrix selected from  $\{C, D, E\}$  as a vector of linear space. The existence solutions requires that the determinant associated with the tensor product of other two matrices vanishes. This matrix is dynamical. Same applies to the tensor product of any of the matrices.

5. Hyper-determinant [?] is the generalization of the notion of determinant whose vanishing tells that multilinear equations have solutions. Now the vanishing of the hyper-determinant defined for the tensor product of the three-fold tensor power of the vector space defined by the coefficients of the Taylor expansion should provide the appropriate manner to characterize the conditions for the existence of the solutions. As already seen, solutions indeed exist so that the hyper-determinant must vanish. The elements of the hyper matrix are now products of determinants for the exponents of the monomials involved. The non-locality of the Kähler function as a functional of the partonic surface leads to the argument that the field equations of TGD for vanishing  $n$ :th variations of Kähler action are multilinear and that a vanishing of a generalized hyper-determinant characterizes this [?] .
6. Since the differential operators are homogenous polynomials of partial derivatives, the total degrees of  $M_m(Z)$  and  $M_n(W)$  defined as a sum  $D = \sum m_i$  is reduced by one unit by the action of both operators  $\partial_{ij}$ . For given value of  $M$  and  $N$  only the products

$$M_m(Z)M_n(W)M_k(Z)M_r(W)M_s(Z)M_l(W)$$

for which the vector valued degrees  $D_1 = m + k + r$  and  $D_2 = n + l + s$  have the same value are coupled. Since the degree is reduced by the operators appearing in the equation, polynomial solutions for which  $f^i$  contain monomials labelled by vectors  $m_i, n_i, r_i$  for which the components vary in a finite range  $(0, n_{max})$  look like a natural solution ansatz. All the degrees  $D_i \leq D_{i,max}$  appear in the solution ansatz so that quite a large number of conditions is obtained.

What is nice is that the equation can be interpreted as a difference equation in 3-D lattice with "time direction" defined by the direction of the diagonal.

1. The counterparts of time=constant slices are the planes  $n_1 + n_2 + n_3 = n$  defining outer surfaces of simplices having  $E$  as a normal vector. The difference equation does not seem to say nothing about the behavior in the transversal directions.  $M$  and  $N$  vary in the simplex planes satisfying  $\sum M_i = T_1$ ,  $\sum N_i = T_2$ . It seems natural to choose  $T_1 = T_2 = T$  so that  $Z$  and  $W$  dynamics corresponds to the same "time". The number of points in the  $T = constant$  simplex plane increases with  $T$  which is analogous to cosmic expansion.
2. The "time evolution" with respect to  $T$  can be solved iteratively by increasing the value of  $\sum M_i = N_i = T$  by one unit at each step. Suppose that the values of coefficients are known and satisfy the conditions for  $(m, k, r)$  and  $(n, l, s)$  up to the maximum value  $T$  for the sum of the components of each of these six vectors. The region of known coefficients -"past"- obviously corresponds to the interior of the simplex bounded by the plane  $\sum M_i = \sum N_i = T$  having  $E$  as a normal. Let  $(m_{min}, n_{min})$ ,  $(k_{min}, l_{min})$  and  $(r_{min}, s_{min})$  correspond to the smallest values of 3-indices for which the coefficients are non-vanishing- this could be called the moment of "Big Bang". The simplest but not necessary assumption is that these indices correspond zero vectors  $(0, 0, 0)$  analogous to the tip of light-cone.
3. For given values of  $M$  and  $N$  corresponding to same value of "cosmic time"  $T$  one can separate from the formula the terms which correspond to the un-known coefficients as the sum  $C_{M+E, N+E} D_{0,0} E_{0,0} + D_{M+E, N+E} D_{0,0} C_{0,0} + E_{M+E, N+E} C_{0,0} D_{0,0}$ . The remaining terms are by assumption already known. One can fix the normalization by choosing  $C_{0,0} = D_{0,0} = E_{0,0} = 1$ .

With these assumptions the equation reduces at each point of the outer boundary of the simplex to the form

$$C_{M+E,N+E} + D_{M+E,N+E} + E_{M+E,N+E} = X$$

where  $X$  is something already known and contain only data about points in the plane  $m+k+r = M$  and  $n+r+s = N$ . Note that these planes have one "time like direction" unlike the simplex plane so that one could speak about a discrete analog of string world sheet in 3+3+3-D lattice space defined by a 2-plane with one time-like direction.

4. For each point of the simplex plane one has equation of the above form. The equation is non-deterministic since only constrain only the sum  $C_{M+E,N+E} + D_{M+E,N+E} + E_{M+E,N+E}$  at each point of the simplex plane to a plane in the complex 3-D space defined by them. Hence the number of solutions is very large. The condition that the solutions reduce to polynomials poses conditions on the coefficients since the quantities  $X$  associated with the plane  $T = T_{max}$  must vanish for each point of the simplex plane in this case. In fact, projective invariance means that the functions involved are homogenous functions in projective coordinates and thus polynomials and therefore reduce to polynomials of finite degree in 3-D treatment. This obviously gives additional condition to the equations.

**The minimally non-linear option**

The simple equation just discussed should be taken with a caution since the non-determinism seems to be too large if one takes seriously the analogy with classical dynamics. By the vacuum degeneracy also the time evolution associated with Kähler action breaks determinism in the standard sense of the word. The non-determinism is however not so strong and removed completely in local sense for non-vacuum extremals. One could also try to see the non-determinism as the analog for non-deterministic time evolution by quantum jumps.

One can however consider the already mentioned possibility of increasing the number of equations so that one would have three equations corresponding to the three unknown functions  $f^i$  so that the determinism associated with each step would be reduced. The equations in question would be of the same general form but with  $(f^1, f^2, f^3)$  replaced with some other combination.

1. In the genuinely projective situation where one can consider the  $(f^1, f^2, f^3, f^i)$ ,  $i = 1, 2, 3$  as a unique generalization of the equation. This would make the equations quadratic in  $f_i$  and reduce the non-determinism at given step of the time evolution. The new element is that now only monomials  $M_m(z)$  associated with the  $f^i$  with same degree of homogeneity defined by  $d = \sum m_i$  are consistent with projective invariance. Therefore the solutions are characterized by six integers  $(d_{i,1}, d_{i,2})$  having interpretation as analogs of conformal weights since they correspond to eigenvalues of scaling operators. That homogenous polynomials are in question gives hopes that a generalization of Witten's approach might make sense. The indices  $m$  vary at the outer surfaces of the six 3-simplices defined by  $(d_{i,1}, d_{i,2})$  and looking like tetrahedrons in 3-D space. The functions  $f^i$  are highly analogous to the homogenous functions appearing in group representations and quantum classical correspondence could be realized through the representation of the space-time surfaces in this manner.
2. The 3-determinants  $(a, b, c)$  appearing in the equations would be replaced by 4-determinants and the equations would have the same general form. One has

$$\sum_{k,l,r,s,t,u} C_{M-k-r-t+E,N-l-s-u+E} D_{k,l} E_{r,s} C_{t,u} \times \\ \times (M - k - r - t + E, k, r, t)(N - l - s - u + E, l, s, u) = 0 \ , \\ E = e_1 + e_2 + e_3 + e_4 \ , \ (a, b, c, d) = \epsilon^{ijkl} a_i b_j c_k d_l \ . \tag{9.5.12}$$

and its variants in which  $D$  and  $E$  appear quadratically. The values of  $M$  and  $N$  are restricted to the tetrahedrons  $\sum M_i = \sum d_{k,1} + d_{1,i}$  and  $\sum N_i = \sum d_{i,2} + d_{i,2}$ ,  $i = 1, 2, 3$ . Therefore

the dynamics in the index space is 3-dimensional. Since the index space is in a well-defined sense dual to  $CP_3$  as is also the  $CP_3$  in which the solutions are represented as counterparts of 3-surfaces, one could say that the 3-dimensionality of the dynamics corresponds to the dynamics of Chern-Simons action at space-like at the ends of  $CD$  and at light-like 3-surfaces.

3. The view based on 4-D time evolution is not useful since the solutions are restricted to time=constant plane in 4-D sense. The elimination of one of the projective coordinates would lead however to the analog of the above describe time evolution. In four-D context a more appropriate form of the equations is

$$\sum_{m,n,k,l,r,s} C_{m,n} D_{k,l} E_{r,s} C_{t,u}(m, k, r, t)(n, l, s, u) M_{m+k+r-E}(Z) M_{n+l+s-E}(W) = 0 \tag{9.5.13}$$

with similar equations for  $f^2$  and  $f^3$ . If one assumes that the  $CP_2$  image of the holomorphic 3-surface is unique (it can correspond to either  $CP_3$ ) the homogenous polynomials  $f^i$  must be symmetric under the exchange of  $Z$  and  $W$  so that the matrices  $C, D$ , and  $E$  are symmetric. This is equivalent to a replacement of the product of determinants with a sum of 16 products of determinants obtained by permuting the indices of each index pair  $(m, n), (k, l), (r, s)$  and  $(t, u)$ .

4. The number  $N_{cond}$  of conditions is given by the product  $N_{cond} = N(d_M)N(d_N)$  of numbers of points in the two tetrahedrons defined by the total conformal weights

$$\sum M_r = d_M = \sum_k d_{k,1} + d_{i,1} \text{ and } \sum N_r = d_N = \sum_k d_{k,2} + d_{i,2} \text{ , } i = 1, 2, 3.$$

The number  $N_{coeff}$  of coefficients is

$$N_{coeff} = \sum_k n(d_{k,1}) + \sum_k n(d_{k,2}) \text{ ,}$$

where  $n(d_{k,i})$  is the number points associated with the tetrahedron with conformal weight  $d_{k,i}$ . Since one has  $n(d) \propto d^3$ ,  $N_{cond}$  scales as

$$N_{cond} \propto d_M^3 d_N^3 = \left(\sum_k d_{k,1} + d_{i,1}\right)^3 \times \left(\sum_k d_{k,2} + d_{i,2}\right)^3$$

whereas the number  $N_{coeff}$  of coefficients scales as

$$N_{coeff} \propto \sum_k (d_{k,1}^3 + d_{k,2}^3) \text{ .}$$

$N_{cond}$  is clearly much larger than  $N_{coeff}$  so the solutions are analogous to partial waves and that the reduction of the rank for the matrices involved is an essential aspect of being a solution. The reduction of the rank for the coefficient matrices should reduce the effective number of coefficients so that solutions can be found. An interesting question is whether the coefficients are rationals with a suitable normalization allowed by independent conformal scalings. An analogy for the dynamics is quantum entanglement for 3+3 systems respecting the conservation of conformal weights and quantum classical correspondence taken to extreme suggests something like this.

5. One can interpret these equations as linear equations for the coefficients of the either linear term or as quadratic equations for the non-linear term. Also in the case of quadratic term one can apply general linear methods to identify the vanishing eigen values of the matrix of the quadratic form involved and to find the zero modes as solutions. The rank of the dynamically determined multiplier matrix must be non-maximal for the solutions to exist. One can imagine that the rank changes at critical surfaces in the space of Taylor coefficients meaning a multi-furcation in



the space determined by the coefficients of the polynomials. Also the degree of the polynomial can change at the critical point.

Solutions for which either determinant vanishes for all terms present in the solution exist. This is achieved if either the index vectors  $(m, l, r, t)$  or  $(n, l, s, u)$  in their respective parallel 3-planes are also in a 3-plane going through the origin. These solutions might be seen as the analogs of vacuum extremals of Chern-Simons action for which the  $CP_2$  projection is at most 2-D Lagrangian manifold.

Quantum classical correspondence requires that the space-time surface carries also information about the momenta of partons. This information is quasi-continuous. Also information about zero modes should have representation in terms of the coefficients of the polynomials. Is this really possible if only products of polynomials of fixed conformal weights with strong restrictions on coefficients can be used? The counterpart for the vacuum degeneracy of Kähler action might resolve the problem. The analog for the construction of space-time surfaces as deformations of vacuum extremals would be starting from a trivial solution and adding to the building blocks of  $f^i$  some terms of same degree for which the wave vectors are not in the intersection of a 3-plane and simplex planes. The still existing "vacuum part" of the solution could carry the needed information.

6. One can take "obvious solutions" characterized by different common 3-planes for the "wave vectors" characterizing the 8 monomials  $M_a(Z)$  and  $M_b(W)$ ,  $a \in \{m, k, r, t\}$  and  $b \in \{n, l, s, u\}$ . The coefficient matrices  $C, D, E, F$  are completely free. For the sum of these solutions the equations contain interaction terms for which at least two "wave vectors" belong to different 3-planes so that the corresponding 4-determinants are non-vanishing. The coefficients are not anymore free. Could the "obvious solutions" have interpretation in terms of different space-time sheets interacting via wormhole contacts? Or can one equate "obvious" with "vacuum" so that interaction between different vacuum space-time sheets via wormhole contact with 3-D  $CP_2$  projection would deform vacuum extremals to non-vacuum extremals? Quantum classical correspondence inspires the question whether the products for functions  $f_i$  associated with an obvious solution associated with a particular plane correspond to a tensor products for quantum states associated with a particular partonic 2-surface or space-time sheet.
7. Effective 2-dimensionality realized in terms of the extremals of Chern-Simons actions with Lagrange multiplier term coming from the weak form of electric magnetic duality should also have a concrete counterpart if one takes the analogy with the extremals of Kähler action seriously. The equations can be transformed to 3-D ones by the elimination of the fourth coordinate but the interpretation in terms of discrete time evolution seems to be impossible since all points are coupled. The total conformal weights of the monomials vary in the range  $[0, d_{1,i}]$  and  $[0, d_{2,i}]$  so that the non-vanishing coefficients are in the interior of 3-simplex. The information about the fourth coordinate is preserved being visible via the four-determinants.
8. It should be possible to relate the hierarchy with respect to conformal weights would to the geometrization of loop integrals if a generalization of twistor strings is in question. One could hope that there exists a hierarchy of solutions with levels characterized by the rank of the matrices appearing in the linear representation. There is a temptation to associate this hierarchy with the hierarchy of deformations of vacuum extremals of Kähler action forming also a hierarchy. If this is the case the obvious solutions would correspond to vacuum extremals. At each step when the rank of the matrices involved decreases the solution becomes nearer to vacuum extremal and there should exist vanishing second variation of Kähler action. This structural similarity gives hopes that the proposed ansatz might work. Also the fact that a generalization of the Penrose's twistorial description for the solutions of Maxwell's equations to the situation when Maxwell field is induced from the Kähler form of  $CP_2$  raises hopes. One must however remember that the consistency with other proposed solution ansätze and with what is believed to be known about the preferred extremals is an enormously powerful constraint and a mathematical miracle would be required.

## 9.6 Comparing twistor revolution with TGD revolution

Lubos Motl saved my Sunday by giving a link to an excellent talk by Nima Arkani-Hamed about the latest twistorial breakthroughs. Lubos Motl talks about "minirevolution" but David Gross uses a more appropriate expression "uprising". I would prefer to speak about revolution inducing at the sociological level a revolt. One must give up QFT in fixed space-time and string theory, and replace them with a theory whose name Nima guesses to be just "T".

For some time ago Lubos Motl told about the latest articles from Nima and collaborators: A Note on Polytopes for Scattering Amplitudes and Local Integrals for Planar Scattering Amplitudes.

Soon after this Lubos Motl gave a link to a video in which Witten talked about knot invariants. This talk was very inspiring and led to TGD based vision about how to calculate invariants of braids, braid cobordisms, and 2-knots in TGD framework and the idea that TGD could be seen as symplectic QFT for calculating these invariances among other things. Much of work was just translation of the basic ideas involved to TGD framework.

One crucial observation was that one can assign to the symplectic group of  $\delta M_+^4 \times CP_2$  gerbe gauge potentials generalizing ordinary gauge potentials in terms of which one can define infinite number of classical 2-fluxes allowing to generalize Wilson loop to a Wilson surface. Most importantly, a unique identification for the decomposition of space-time surface to string world sheets identified as singularities of induce gauge fields and partonic 2-surfaces emerged and one can see the two decompositions as dual descriptions. TGD as almost topological QFT concretized to a symplectic QFT for knots, braids, braid cobordisms, and 2-knots. These ideas are documented in the chapter Knots and TGD of "TGD: Physics as Infinite-Dimensional Geometry" [?] . I did not realize the obvious connection with twistor approach as I wrote the new chapter.

In his rather energetic lecture Nima emphasized how the Yangian symmetry originally discovered in 2-D QFTs, algebraic geometry, twistor theory, and string theory fuse to something bigger called "T". I realized that the twistorial picture developed in the earlier postings integrates nicely with the braided vision inspired by Witten's talk and that one could understand in TGD framework why twistor description, Yangian symmetry of 2-D integrable systems, and algebraic geometry picture are so closely related. In particular, the dual conformal symmetries of twistor approach could be understood in terms of duality between partonic 2-surfaces and string world sheets expressing the strong form of holography. Also a generalization for the dual descriptions provided by super Wilson loop and ordinary scattering amplitude in  $\mathcal{N} = 4$  SUSY in terms of Wilson sheets suggests itself among many other things. Also a rather obvious solution to the problem posed by non-planar diagrams to twistor approach suggests itself. Planar diagrams are simply not present and parton-string duality and huge symmetries of TGD give good reasons for why this should be the case.

### 9.6.1 The declaration of revolution by Nima from TGD point of view

At first look Nima's program is a declaration of revolution against all sacred principles. Nima dooms space-time, wants to get rid of QFT, does not even explicitly care about unitarity, and wants to throw Feynman diagrams to paper basket. Nima does not even respect string theory and sees it only as one particular- possibly not the best- manner to describe the underlying simplicity.

#### Give up space-time

In many respects I agree with Nima about the fate of space-time of QFT. I however see Nima's view a little bit exaggerated: one can perhaps compute scattering amplitudes without Minkowski space but one cannot translate the results of computations to the language of experiments without bringing in frequencies and wavelengths, classical fields, and therefore also space-time. Quantum classical correspondence: this is needed and this brings space-time unavoidably into the picture. Space-time surface serves as a dynamical correlate for quantum dynamics- generalized Bohr orbit required by General Coordinate Invariance and strong form of holography. The enormously important implication is absence of Feynman graphs in ordinary sense since there is no path integral over space-time surface but just single surface: the preferred extremal of Kähler action is enough (forgetting the delicacies caused by the failure of classical determinism in standard sense for Kähler action allowing to realize also the space-time correlates of quantum jump sequences).

Nima uses black hole based arguments to demonstrate that local observables are not operationally defined in neither gravitational theories nor quantum field theories and concludes that space-time is doomed. What would remain would be 4-D space-time regarded as a boundary of higher dimensional space-time (AdS/CFT correspondence). I think that this is quite too complex and that the reduction in degrees of freedom is much more radical: the landscape misery is after all basically due to the exponential inflation in the number of degrees of freedom due to the fatal mistake of making 10-D or 11-D target space dynamical.

What remains in TGD are boundaries of space-time surfaces at the upper and lower ends of causal diamonds  $CD \times CP_2$  (briefly  $CD$ ) and wormhole throats at which the signature of induced metric changes from Euclidian to Minkowskian (recall that Euclidian regions represent generalized Feynman diagrams).  $CD$  is essentially a representation of Penrose diagram which fits nicely with twistor approach. Strong form of holography implies that partonic 2-surfaces (or dual string world sheets) and 4-D tangent space data are enough as basic particle physics objects. The rest of space-time is needed to realized quantum classical correspondence essential for quantum measurement theory.

The basic message of TGD is that quantum superpositions of space-time surfaces are relevant for physics in all scales. Particles are the dynamical space-time quanta. There is however higher-dimensional space-time which is fixed and rigid  $H = M^4 \times CP_2$  and is needed for the symmetries of the theory and guarantees the Kähler geometric existence of the world of classical worlds (WCW). This simplifies the situation enormously: instead of 10- or 11-D dynamical space-time one has just 4-D space-time and 2-D surfaces plus 4-D tangent space data. Holography is what we experience it to be: we see only 2-D surfaces. And physics is experimental science although some super string theorists might argue something else!

### Give up fields

Nima argues also that fields are doomed too. I must say that I do not like this Planck length mysticism: it assumes quite too much and in TGD framework something new emerge already in  $CP_2$  scale about  $10^4$  longer than Planck scale. According to Nima all this pain with Feynman diagrams would be due to the need to realize unitary representations of Poincare group in terms of fields. For massless particles one is forced to assume gauge invariance to eliminate the unphysical polarizations. Nima sees gauge invariance as the source of all troubles. Here I do not completely agree with Nima. The unitary time evolution in fixed space-time translated to the path integral over classical fields is what leads to the combinatorial nightmare of summing over Feynman diagrams and plagues also  $\phi^4$  theory. Amusingly, as Nima emphasizes all this has been known for 60 years. It is easy to understand that the possibility to realize unitarity elegantly using Feynman diagrams led to the acceptance of this approach as the only possible one.

In TGD framework the geometry of sub-manifolds replaces fields: the dynamics of partonic 2-surfaces identified as throats of light-like wormhole contacts containing fermions at them gives rise to bosons as bound states of fermions and antifermions. There is no path integral over space-time surfaces, just functional integral over partonic 2-surfaces so that path integral disappears. In zero energy ontology this means that incoming states are bound states of massless fermions and antifermions at wormhole throats and virtual states consist also of massless fermions but without the bound state constraint. This means horribly strong kinematic constraints on vertices defined by partonic 2-surfaces and UV finiteness and IR finiteness are automatic outcome of the theory. Massivation guaranteeing IR finiteness is consistent with massless-ness of fundamental particles since massive states are bound states of massless particles.

Nima talks also about emergence as something fundamental and claims that also space-time emerges. In TGD framework emergence has very concrete meaning. All particles are bound states of massless fermions and the additional purely bosonic degrees of freedom correspond to vibrational degrees of freedom for partonic 2-surfaces.

What is lacking from the program of Nima is the vision about physics as a geometry of worlds of classical worlds [K60] and physics as generalized number theory [K70]. This is what makes the higher-D imbedding space unique and allows the geometrization of quantum physics and identification of standard model symmetries as number theoretical symmetries. Infinite-dimensional geometry is unique just from the requirement that it exists!

### 9.6.2 Basic results of twistor approach from TGD point of view

The basic ideas of twistor approach are remarkably consistent with the basic picture of TGD.

#### Only on mass-shell amplitudes appear in the recursion formula

What is striking that the recursion formula of Nima and collaborators for the integrands of the planar amplitudes of  $\mathcal{N} = 4$  SUSY involve only on mass shell massless particles in the role of intermediate states. This is in sharp conflict with not only Feynman diagrammatic intuition but also with the very path integral ideology motivated by the need to realize unitary time development.

As already mentioned, in ZEO (zero energy ontology) all states- both on mass shell and off mass shell are composites of massless states assigned to 2-D partonic surfaces. Path integral is indeed replaced with generalized Bohr orbits and one obtains only very few generalized Feynman diagrams. What remains is functional integral over 3-surfaces, or even less over partonic 2-surfaces with varying tangent space data.

A further simplification is that as a result of the dynamics of preferred extremals many particle states correspond to discrete sets of points at partonic 2-surfaces serving as the ends of orbits of braid strands and possibly also 2-knots and functional integral involves integral over different configurations of these points [?]. The physical interpretation is as a realization of finite measurement resolution as a property of dynamics itself. The string world sheets are uniquely identified as inverse images under imbedding map of space-time surface to  $H = M^4 \times CP_2$  of homologically non-trivial geodesic sphere of  $CP_2$  defining homological magnetic monopole. Holography in its strongest sense states that all information about non-trivial 2-homology of space-time surface and knottedness of the string world sheets is coded to the data at partonic 2-surfaces. For details see the chapter Knots and TGD of "TGD: Physics as Infinite-Dimensional Geometry [?]."

#### Twistors and algebraic geometry connection emerge naturally in TGD framework

$H = M^4 \times CP_2$  and the reduction of all on mass shell states to bound states of massless states imply that twistor approach is the natural description of scattering amplitudes in TGD framework.

What is new that one must convolute massless theories in the sense that opposite throats of  $CP_2$  sized wormhole contacts carry massless states. This allows to get rid of IR divergencies and realized exact Yangian symmetry by a purely physical mechanism making particle states massive.

An important implication is that even photon, gluons, and graviton have small masses and that in TGD framework all components of Higgs field are eaten by electroweak gauge bosons. Also gluons have colored scalar and pseudo-scalar counterparts and already now there are some hints at LHC for pseudo-scalar gluons. The discovery of Higgs can of course kill this idea anytime.

The connection with twistors allows to understand how algebraic geometry of projective spaces emerges in TGD framework and one indeed ends up to an alternative formulation of quantum TGD with space-time surfaces in  $H$  replaced with holomorphic 6-surfaces of  $CP_3 \times CP_3$ , which are sphere bundles and there effectively 4-D. The equations determining the 6-surfaces are dictated by rather general constraints.

#### Dual descriptions in terms of QFT and strings

The connections of  $\mathcal{N} = 4$  SUSY with 2-D integrable systems and the possibly of both stringy and QFT descriptions characterized by dual conformal symmetries giving rise to Yangian invariance reduce in TGD framework to the duality between descriptions based on string world sheets and partonic 2-surfaces.

1. The connection with string description emerges from the basic TGD in the sense that one can localize the solutions of the modified Dirac equation [?] at braid strands located at the light-like 3-D wormhole throats. Similar localization to string world sheets defined in the above described manner holds true in space-time interior. The solutions of the modified Dirac equation localized to braid strands (and to string world sheets in space-time interior) are characterized by what I called pseudo momenta not directly identifiable as momenta. The natural identification is as region momenta of the twistor approach. Recall that the twistorialization of region momenta leads to the momentum twistor approach making dual conformal invariance manifest.

2. The strange looking localization of fermions at braid strands makes mathematically sense only because the classical dynamics of preferred extremals reduces to hydrodynamics such that the flow parameters for flow lines integrate to global coordinates. So called Beltrami flows are in question and mean that preferred extremals have interpretation as perfect fluid flows for which dissipation is minimal [?]. This property implies also the almost topological QFT property of TGD meaning that Kähler action reduces to Chern-Simons action localized at light-like wormhole throats and space-like 3-surfaces at the ends of CDs.
3. The mathematical motivation on braid strands comes from the fact that this allows to avoid delta functions in the anticommutators of fermionic oscillator operators at partonic 2-surfaces and therefore also the basic quadratic divergences of quantum field theories. Oscillator algebra has countable -perhaps even finite number- of generators and the loss of complete locality is in terms of finite measurement resolution. The larger the number of braid points selected at partonic 2-surface, the larger the number string world sheets and the higher the complexity of space-time surface. This obviously means a concrete realization of holography. The oscillator algebra has interpretation as SUSY algebra with arbitrarily large  $N$  fixed by the number of braid points. This SUSY symmetry is dynamical and badly broken. For right handed neutrino the breaking is smallest but also in this case the mixing of left- and right handed  $M^4$  chiralities in modified Dirac equation implies non-conservation of R-parity as well as particle massivation and also the absence of lightest stable SUSY partner, which means that one particular dark matter candidate is out of game.
4. The big difference between TGD and string models is that super generators do not correspond to Majorana spinors: this is indeed impossible for  $M^4 \times CP_2$  since it would mean non-conservation of baryon and lepton numbers. I believed for a long time that stringy propagators emerge from TGD and the long standing painful question was what about stringy propagator defined by the inverse  $1/G$  of the hermitian super generator in string models. In TGD  $1/G$  cannot define stringy propagator since  $G$  carries fermion number. The reduction of strings to pairs of massless particles saves the situation and ordinary massless propagator for the counterparts of region momenta gives well defined propagators for on mass shell massless states! Stringy states reduce to bound states of massless particles in accordance with emergence philosophy. Nothing is scared these days!

### Connection with integrable 2-D discrete systems

Twistor approach has revealed a striking connection between 2-D integrable systems and  $\mathcal{N} = 4$  SUSY. For instance, one can calculate the anomalous dimensions of  $\mathcal{N} = 4$  SUSY from an integrable model for spin chain in 2 dimensions without ever mentioning Feynman diagrams.

The description in terms of partonic 2-surfaces mean a direct connection with braids appearing in 2-D integrable thermodynamical systems and the description in terms of string world sheets means connection with integrable theories in 2-D Minkowski space. Both theories involve Yangian symmetry [?] for which there exists a hierarchy of non-local conserved charges. Super-conformal invariance and its dual crucial for Yangian symmetry correspond to partonic 2-surfaces and string world sheets. The symmetry algebra is extended dramatically. In  $\mathcal{N} = 4$  SUSY one has Yangian of conformal algebra of  $M^4$ . In TGD this algebra is generalized to include the super Kac-Moody algebra associated with isometries of the imbedding space, the super-conformal variant of the symplectic algebra of  $\delta M^4 \times CP_2$ , and also conformal transformations of  $M^4$  mapping given boundary of  $CD$  to itself.

This allows also to understand and generalize the duality stating that QFT amplitudes for  $\mathcal{N} = 4$  SUSY have interpretation as supersymmetric Wilson loops in dual Minkowski space. The ends of braid strands indeed define Wilson loops. In TGD framework work one must however generalize Wilson loops to Wilson sheets [?] and the circulations of gauge potentials are replaced with fluxes of gerbe gauge potentials associated with the symplectic group of  $\delta M^4_+ \times CP_2$ . As noticed, dual conformal symmetries correspond to duality of partonic 2-surfaces and string world sheets implied by the 2-D holography for string world sheets.

### 9.6.3 Could planar diagrams be enough in the theory transcending $\mathcal{N} = 4$ SUSY?

Twistor approach as it appears in  $\mathcal{N} = 4$  SYM is of course not the final solution.

1.  $\mathcal{N} = 4$  SUSY is not enough for the purposes of LHC.
2. The extremely beautiful Yangian symmetry fails as one performs integration to obtain the scattering amplitudes and generates IR singularities. ZEO provides an elegant solution to this problem by replacing physical on mass shell particles with bound states of massless particles. Also string like objects emerge as this kind of states.
3. Only planar diagrams allow to assign to the sum of Feynman diagrams a single integrand defining the twistor diagram. Something definitely goes wrong unless one is able to treat the non-planar diagrams. The basic problem is that one cannot assign common loop momentum variables to all diagrams simultaneously and this is due to the tricky character of Feynman diagrams. It is difficult to integrate without integrand!

The easy-to-guess question is whether the sum over the non-planar diagrams vanishes or whether they are just absent in a theory transcending  $\mathcal{N} = 4$  SUSY and QFTs. Let  $N$  denote the number of colors of the SUSY. For  $N \rightarrow \infty$  limit with  $g^2 N$  fixed only planar diagrams survive in this kind of theory and one obtains a string model like description as conjectured long time ago by 't Hooft [?]. This argument led later to AdS/CFT duality.

The stringy diagrams in TGD framework could correspond to planar diagrams of  $\mathcal{N} = 4$  QFT. Besides this one would have a functional integral over partonic 2-surfaces.

1. The description would be either in terms of partonic 2-surfaces or string world sheets with both determined uniquely in terms of a slicing of space-time surface with physical states characterized in terms of string world sheets in finite measurement resolution.
2.  $N \rightarrow \infty$  limit could in TGD framework be equivalent with two replacements. The color group with the infinite-D symplectic group of  $\delta M_{\pm}^4 \times CP_2$  and symplectic group and isometry group of  $H$  are replaced with their conformal variants.
3. Could  $g^2 N = \text{constant}$  be equivalent with the use of hyper-finite factors of type  $II_1$  [K82] for which the trace of the unit matrix equals to 1 instead of  $\mathcal{N} = \infty$ . These factors characterize the spinor structure of WCW identifiable in terms of Clifford algebra defined by infinite-D fermionic oscillator algebra defined by second quantized fermions at partonic 2-surfaces.

### 9.6.4 Motives and twistors

Nima mentions at the end of his talk motives [?] . I know about this abstract branch of algebraic geometry only that it is an attempt to build a universal cohomology theory, which in turn is an algebraic approach to topology allowing to linearize highly non-linear situations encountered typically in algebraic geometry where topology is replaced with holomorphy which is much more stringent property and allows richer structures.

1. Physics as generalized number theory vision involving also fusion of real and p-adic number fields to a larger super structure brings algebraic geometry to the core of TGD. The partonic 2-surfaces allowing interpretation as inhabitants of the intersection of real and p-adic worlds serve as correlates for living matter in TGD Universe. They are algebraic surfaces allowing in preferred coordinates a representation in terms of polynomials with rational coefficients. Motives would be needed to understand the cohomology of these surfaces. One encounters all kinds of problems such as counting the number of rational points in the intersection of p-adic and real variants of the surface and for algebraic surfaces this reduces to the counting of rational points for real 2-surface about which algebraic geometers know a lot of. For instance, surfaces of form  $x^n + y^n + z^n = 0$  for  $n \geq 3$  appearing in Fermat's theorem are child's play since they allow only origin as a common point.

2. As cautiously concluded in "Knots and TGD" [?] , the intersection form for string world sheets defines a representation of the second relative homology of space-time surface and by Poincare duality also second cohomology. "Relative" is with respect to ends of space-time at the boundaries of CDs and light-like wormhole throats. The intersection form characterizing the collection of self-intersection points at which the braid strands are forced to go through each other is almost enough to characterize connected 4-manifolds topologically by Donaldson theorem [?] .
3. String world sheets define a violent unknotting procedure based on reconnections for braid strands- basic stringy vertex for closed strings- and in this manner knot invariant in the same manner as the recursion allowing to calculate the value of Jones polynomial for a given knot. Quantum TGD gives as a by-product rise to a symplectic QFT describing braids, their cobordisms, and 2-knots. It would not be surprising if the  $M$ -matrix elements would have also interpretation as symplectic covariants providing information about the topology of the space-time surface. The 2-braid theory associated with space-time surface would also characterize its topology just as ordinary knots can characterize topology of 3-manifolds.

To sum up, TGD suggests a surprisingly stringy but at the same time incredibly simple generalization of string model in which the discoveries made possible by the twistor approach to  $\mathcal{N} = 4$  SUSY find a natural generalization. Nima has realized that much more than a mere discovery of computational recipes is involved and indeed talks about T-theory. I feel that the lonely "T" is desperately yearning for the company of "G" and "D"!

### 9.6.5 Reducing non-planar diagrams to planar ones by a generalization of algorithm for calculating knot invariants?

I have been listening some lectures in Strings 2001. The lectures related to progress in the calculation of gauge theory and super-gravity amplitudes are really electrifying: one really feels the sparking enthusiasm of the speakers. Besides twistor revolution there is also other amazing progress taking place in QFT side.

At this morning I started to listen the talk of Henrik Johansson about Lie algebra structures in YM and gravitational amplitudes. I have already earlier written about the finding that there is a symmetry between kinematical numerators of the amplitudes involving polarizations and momenta on one hand and color factors on the other hand, and that one can in well defined sense express gravitational scattering amplitudes in terms of squares of YM amplitudes. This holds true for on mass shell amplitudes. The reduction of the gravitational amplitudes to squares of YM amplitudes would be incredible simplification: even 3-graviton off mass shell vertex contains about 100 terms! As a matter fact, gravitation is a gauge theory too with gauge group replaced with Poincare group so that it would not be totally surprising that this kind of duality between kinematics would hold true.

This duality is not however the topic of this posting. As Johansson was explaining the Jacobi identity for the kinematical Lie algebra I got Eureka experience. What the kinematic Jacobi identity states is following:

*The numerator for four-point amplitude with twisted legs in s-channel is expressible as a **difference of planar s- and t-channel amplitudes.***

If you did not get the association to twistor program already from this sentence, recall that the basic problem of twistor approach are non-planar diagrams. For them one cannot order the loop momenta in such a manner that the ordering would be universal and depend only on the number of loops as it is for planar diagrams without crossings. Hence one is not able to combine all diagrams to single integrand and this is related to the tricks one is forced to apply to make the loop integrals finite: same identification of loop momenta for all diagrams is not possible if one wants finiteness.

What one needs for a generalization of twistor approach to apply to non-planar diagrams is a universal identification of the loop momenta by cancelling all crossings: the amplitude itself need not be equal to the difference of the amplitudes obtained by reconnecting in two manners but could be something more general. This operation would be performed for internal lines only. For external lines it tells that the amplitudes changes possible sign when external lines are permuted. For braid statistics a more phase factor would result.

The duality of old-fashioned string models says that the difference of s- and t-channel amplitudes vanishes so that one can say that amplitudes with twisted legs vanish. Also at large  $N$  (number of

colors) limit of  $\mathcal{N} = 4$  SUSY these differences vanish and YM theory behaves like string theory and planar twistor approach should give exact answers at this limit. In TGD framework the effective replacement of gauge group with infinite-dimensional symplectic group could have the same effect. But what about finite values of  $N$  in super YM theories?

*Could one generalize the twistor approach so that one could calculate all amplitudes by recursion- not only the planar ones?*

Alert reader has of course answered already but I try to explain for non-specialists (with me included). If one has worked with braids and knots, one realizes that the expression for the amplitude as difference of planar amplitudes is analogous to what you get in elementary un-knotting operation for braids annihilating one crossing in the knot diagram! In the process you form the difference of two possible reconnections at the crossing point. If you interpret the process as time evolution, it corresponds to two vertices in which interiors of strings touch each other and reconnect in a new manner. In the construction of Jones polynomial as a knot invariant the repeated application of these un-twisting operations eventually leads to un-knot and you get as an outcome the knot invariant. Also non-planar Feynman diagram is like a knot diagram and the outcome of similar procedure should consist of only planar amplitudes.

For Feynman diagrams one cannot distinguish between upper and lower crossings of the lines. This could be interpreted by saying that both crossings give the same contribution. This is the case if untwisting gives the difference of numerators in both color and momentum degrees of freedom so that the signs cancel and the integrals of both contributions are identical despite the fact that the propagator denominators are not identical. The most general outcome would be a term proportional to the sum of the four planar contributions and one could perhaps treat the situation using twistorial methods. Proportionality coefficient could depend on dimensionless Lorentz scalars constructed from the incoming momenta of the sub-diagram with crossing and dictated to high degree by conformal invariance. Professional could probably demonstrate in five minutes that the conjecture cannot hold true.

Especially, if you have written  $N$  times "Quantum TGD as almost topological QFT ..." you get at the large  $N$  limit the vibe in your spine. Because the combinatorics of an almost topological QFT must be that of a topological QFT and because braids are basic building brick of TGD amplitudes, it should be possible to reduce all non-planar amplitudes -both those of TGD and those of  $\mathcal{N} = 4$  SUSY and even other gauge theories - by a repeated un-twisting to planar amplitudes. A generalization of the basic algorithm of knot theory would become part of twistorial Feynman diagrammatics and could perhaps also be used to *define* the integrand including also the loops with crossings!

If the proposal can be realized in some sense, the rules for calculating the twistor amplitudes would be simple.

1. You - or your knot theoretical friend- must first patiently unknot the Feynman diagrams involved by eliminating all twists using the basic formula allowing to express twisted sub-amplitude with a difference of un-twisted sub-amplitudes. You might even dream that he gives you explicit formulas for the outcome to get rid of your continual requests for help.
2. At the end of the day you get just planar diagrams and you can apply the general recursive formulas of Nima and others working for all numbers of external particles and all numbers of loops to get the *integrand*, which you should be able to integrate.
3. Unfortunately you are not! But you can knock the door of Goncharov and ask whether he could kindly perform the integral using his magic Symbolic Integration Machine [?] about which Anastasia Volovich tells in her talk "Symblifying N=4 SUSY Scattering Amplitudes".

Is this idea just a passing daydream? Or morning dream- my hungry cat forced me to wake up at 3 a'clock so that I might be hallucinating in half-sleeping state. A specialist could immediately tell where this crazy idea of Europe's (if not World's) worst Feynman diagrammatician fails.

### 9.6.6 Langlands duality, electric-magnetic duality, S-duality, finite measurement resolution, and quantum Yangian symmetry

The arguments represented in the chapter "Langlands program and TGD" [?] support the view that in TGD Universe number theoretic and geometric Langlands conjectures could be understood very



naturally. The reader is warmly recommended to consult to this chapter for a more detailed representation.

What is important is that the discussion improves considerably the understanding about TGD proper. Same can be said about other attempts to apply TGD approach to the problems of modern mathematics to which topological quantum field theories have been applied [?, ?, ?]. In particular, a connection of Langlands conjectures and Yangian symmetry emerges. The group  $G$  resp. its Langlands dual  ${}^L G$  would define what might be called twisted quantum Yangian associated with  $G$  resp.  ${}^L G$ . The Lie group  $G$  resp.  ${}^L G$  corresponds to the description of TGD in terms of partonic 2-surfaces resp. string world sheets made possible by strong form of holography in turn implied by strong form of general coordinate invariance implying also electric-magnetic duality and S-duality. Another new result is the identification of the gauge group  $G$  as a group defining the measurement resolution in the approach based on hyperfinite factors of type  $\text{II}_1$  and proposal for the concrete representation of the corresponding Kac-Moody algebra. A further unexpected outcome are S-dual descriptions of TGD in terms of open string world sheets and partonic 2-surfaces in the moduli spaces of each other. Besides TGD based view about space-time, zero energy ontology and the notion of finite measurement resolution are the basic new notions as compared with the approach of Witten and Kapustin [?] to the geometric Langlands duality.

1. Zero energy ontology (ZEO) and the related notion of causal diamond  $CD$  ( $CD$  is a short hand for the cartesian product of causal diamond of  $M^4$  and of  $CP_2$ ). ZEO leads to the notion of partonic 2-surfaces at the light-like boundaries of  $CD$  and to the notion of string world sheet. These notions are central in the recent view about TGD. One can assign to the partonic 2-surfaces a conformal moduli space having as additional coordinates the positions of braid strand ends (punctures). By electric-magnetic duality this moduli space must correspond closely to the moduli space of string world sheets.
2. Electric-magnetic duality realized in terms of string world sheets and partonic 2-surfaces. The group  $G$  and its Langlands dual  ${}^L G$  would correspond to the time-like and space-like braidings. Duality predicts that the moduli space of string world sheets is very closely related to that for the partonic 2-surfaces. The strong form of 4-D general coordinate invariance implying electric-magnetic duality and S-duality as well as strong form of holography indeed predicts that the collection of string world sheets is fixed once the collection of partonic 2-surfaces at light-like boundaries of  $CD$  and its sub- $CD$ s is known.
3. The proposal is that finite measurement resolution is realized in terms of inclusions of hyperfinite factors of type  $\text{II}_1$  at quantum level and represented in terms of confining effective gauge group [K82]. This effective gauge group could be some associate of  $G$ : gauge group, Kac-Moody group or its quantum counterpart, or so called twisted quantum Yangian strongly suggested by twistor considerations. At space-time level the finite measurement resolution would be represented in terms of braids at space-time level. The braids come in two varieties correspond to braids assignable to space-like surfaces at the two light-like boundaries of  $CD$  and with light-like 3-surfaces at which the signature of the induced metric changes and which are identified as orbits of partonic 2-surfaces connecting the future and past boundaries of  $CD$ s.

There are several steps leading from  $G$  to its twisted quantum Yangian. The first step replaces point like particles with partonic 2-surfaces: this brings in Kac-Moody character. The second step brings in finite measurement resolution meaning that Kac-Moody type algebra is replaced with its quantum version. The third step brings in zero energy ontology: one cannot treat single partonic surface or string world sheet as independent unit: always the collection of partonic 2-surfaces and corresponding string worlds sheets defines the geometric structure so that multi-locality and therefore quantum Yangian algebra with multilocal generators is unavoidable. Also ZEO forces multilocality since zero energy states defining orthonormal  $M$ -matrices are define multilocal Kac-Moody type algebra with integer powers of  $S$ -matrix defining the exponent of phase factor assignable with power  $z^n$  in the loop algebra generator.

4. In finite measurement resolution geometric Langlands duality and number theoretic Langlands duality are very closely related since partonic 2-surface is effectively replaced with the punctures representing the ends of braid strands and the orbit of this set under a discrete subgroup of  $G$  defines effectively a collection of "rational" 2-surfaces. The number of the "rational" surfaces

in geometric Langlands conjecture replaces the number of rational points of partonic 2-surface in its number theoretic variant. The ability to compute both these numbers is very relevant for quantum TGD.

5. The natural identification of the associate of  $G$  is quantum Yangian of Kac-Moody type group associated with Minkowskian open string model assignable to string world sheet representing a string moving in the moduli space of partonic 2-surface. The dual group corresponds to Euclidian string model with partonic 2-surface representing string orbit in the moduli space of the string world sheets. The Kac-Moody algebra assigned with simply laced  $G$  is obtained using the standard tachyonic free field representation obtained as ordered exponentials of Cartan algebra generators identified as transversal parts of  $M^4$  coordinates for the braid strands. The importance of the free field representation generalizing to the case of non-simply laced groups in the realization of finite measurement resolution in terms of Kac-Moody algebra cannot be over-emphasized (note that in string models and conformal field theories this realization of vertex operators in terms of free fields is of comparable importance).
6. Langlands duality involves besides harmonic analysis side also the number theoretic side. Galois groups (collections of them) defined by infinite primes and integers having representation as symplectic flows defining braidings. I have earlier proposed that the hierarchy of these Galois groups define what might be regarded as a non-commutative homology and cohomology. Also  $G$  has this kind of representation which explains why the representations of these two kinds of groups are so intimately related. This relationship could be seen as a generalization of the MacKay correspondence between finite subgroups of  $SU(2)$  and simply laced Lie groups.
7. Symplectic group of the light-cone boundary acting as isometries of the WCW geometry [?] allowing to represent projectively both Galois groups and symmetry groups as symplectic flows so that the non-commutative cohomology would have braided representation. This leads to braided counterparts for both Galois group and effective symmetry group.
8. The moduli space for Higgs bundle playing central role in the approach of Witten and Kapustin to geometric Landlands program is in TGD framework replaced with the conformal moduli space for partonic 2-surfaces. It is not however possible to speak about Higgs field although moduli defined the analog of Higgs vacuum expectation value. Note that in TGD Universe the most natural assumption is that all Higgs like states are "eaten" by gauge bosons so that also photon and gluons become massive. This mechanism would be very general and mean that massless representations of Poincare group organize to massive ones via the formation of bound states. It might be however possible to see the contribution of p-adic thermodynamics depending on genus as analogous to Higgs contribution since the conformal moduli are analogous to vacuum expectation of Higgs field.

### 9.6.7 About the structure of the Yangian algebra

The attempt to understand Langlands conjecture in TGD framework led to a completely unexpected progress in the understanding of the Yangian symmetry expected to be the basic symmetry of quantum TGD and the following vision suggesting how conformal field theory could be generalized to four-dimensional context is a fruit of this work.

The structure of the Yangian algebra is quite intricate and in order to minimize confusion easily caused by my own restricted mathematical skills it is best to try to build a physical interpretation for what Yangian really is and leave the details for the mathematicians.

1. The first thing to notice is that Yangian and quantum affine algebra are two different quantum deformations of a given Lie algebra. Both rely on the notion of R-matrix inducing a swap of braid strands. R-matrix represents the projective representations of the permutation group for braid strands and possible in 2-dimensional case due to the non-commutativity of the first homotopy group for 2-dimensional spaces with punctures. The R-matrix  $R_q(u, v)$  depends on complex parameter  $q$  and two complex coordinates  $u, v$ . In integrable quantum field theories in  $M^2$  the coordinates  $u, v$  are real numbers having identification as exponentials representing Lorenz boosts. In 2-D integrable conformal field theory the coordinates  $u, v$  have interpretation as

complex phases representing points of a circle. The assumption that the coordinate parameters are complex numbers is the safest one.

2. For Yangian the R-matrix is rational whereas for quantum affine algebra it is trigonometric. For the Yangian of a linear group quantum deformation parameter can be taken to be equal to one by a suitable rescaling of the generators labelled by integer by a power of the complex quantum deformation parameter  $q$ . I do not know whether this true in the general case. For the quantum affine algebra this is not possible and in TGD framework the most interesting values of the deformation parameter correspond to roots of unity.

### Slicing of space-time sheets to partonic 2-surfaces and string world sheets

The proposal is that the preferred extremals of Kähler action are involved in an essential manner the slicing of the space-time sheets by partonic 2-surfaces and string world sheets. Also an analogous slicing of Minkowski space is assumed and there are infinite number of this kind of slicings defining what I have called Hamilton-Jacobi coordinates [K9]. What is really involved is far from clear. For instance, I do not really understand whether the slicings of the space-time surfaces are purely dynamical or induced by special coordinatizations of the space-time sheets using projections to special kind of sub-manifolds of the imbedding space, or are these two type of slicings equivalent by the very property of being a preferred extremal. Therefore I can represent only what I think I understand about the situation.

1. What is needed is the slicing of space-time sheets by partonic 2-surfaces and string world sheets. The existence of this slicing is assumed for the preferred extremals of Kähler action [K9]. Physically the slicing corresponds to an integrable decomposition of the tangent space of space-time surface to 2-D space representing non-physical polarizations and 2-D space representing physical polarizations and has also number theoretical meaning.
2. In zero energy ontology the complex coordinate parameters appearing in the generalized conformal fields should correspond to coordinates of the imbedding space serving also as local coordinates of the space-time surface. Problems seem to be caused by the fact that for string world sheets hyper-complex coordinate is more natural than complex coordinate. Pair of hyper-complex and complex coordinate emerge naturally as Hamilton-Jacobi coordinates for Minkowski space encountered in the attempts to understand the construction of the preferred extremals of Kähler action.

Also the condition that the flow lines of conserved isometry currents define global coordinates lead to the to the analog of Hamilton-Jacobi coordinates for space-time sheets [K9]. The physical interpretation is in terms of local polarization plane and momentum plane defined by local light-like direction. What is so nice that these coordinates are highly unique and determined dynamically.

3. Is it really necessary to use two complex coordinates in the definition of Yangian-affine conformal fields? Why not to use hyper-complex coordinate for string world sheets? Since the inverse of hyper-complex number does not exist when the hyper-complex number is light-like, hyper-complex coordinate should appear in the expansions for the Yangian generalization of conformal field as positive powers only. Intriguingly, the Yangian algebra is "one half" of the affine algebra so that only positive powers appear in the expansion. Maybe the hyper-complex expansion works and forces Yangian-affine instead of doubly affine structure. The appearance of only positive conformal weights in Yangian sector could also relate to the fact that also in conformal theories this restriction must be made.
4. It seems indeed essential that the space-time coordinates used can be regarded as imbedding space coordinates which can be fixed to a high degree by symmetries: otherwise problems with general coordinate invariance and with number theoretical universality would be encountered.
5. The slicing by partonic 2-surfaces could (but need not) be induced by the slicing of  $CD$  by parallel translates of either upper or lower boundary of  $CD$  in time direction in the rest frame of  $CD$  (time coordinate varying in the direction of the line connecting the tips of  $CD$ ). These slicings are not global. Upper and lower boundaries of  $CD$  would definitely define analogs of different coordinate patches.

### Physical interpretation of the Yangian of quantum affine algebra

What the Yangian of quantum affine algebra or more generally, its super counterpart could mean in TGD framework? The key idea is that this algebra would define a generalization of super conformal algebras of super conformal field theories as well as the generalization of super Virasoro algebra. Optimist could hope that the constructions associated with conformal algebras generalize: this includes the representation theory of super conformal and super Virasoro algebras, coset construction, and vertex operator construction in terms of free fields. One could also hope that the classification of extended conformal theories defined in this manner might be possible.

1. The Yangian of a quantum affine algebra is in question. The heuristic idea is that the two R-matrices - trigonometric and rational- are assignable to the swaps defined by space-like braidings associated with the braids at 3-D space-like ends of space-time sheets at light-like boundaries of  $CD$  and time like braidings associated with the braids at 3-D light-like surfaces connecting partonic 2-surfaces at opposite light-like boundaries of  $CD$ . Electric-magnetic duality and S-duality implied by the strong form of General Coordinate Invariance should be closely related to the presence of two R-matrices. The first guess is that rational R-matrix is assignable with the time-like braidings and trigonometric R-matrix with the space-like braidings. Here one must of course be very cautious.
2. The representation of the collection of Galois groups associated with infinite primes in terms of braided symplectic flows for braid of braids of ... braids implies that there is a hierarchy of swaps: swaps can also exchange braids of ...braids. This would suggest that at the lowest level of the braiding hierarchy the R-matrix associated with a Kac-Moody algebra permutes two braid strands which decompose to braids. There would be two different braided variants of Galois groups.
3. The Yangian of the affine Kac-Moody algebra could be seen as a 4-D generalization of the 2-D Kac-Moody algebra- that is a local algebra having representation as a power series of complex coordinates defined by the projections of the point of the space-time sheet to geodesic spheres of light-cone boundary and geodesic sphere of  $CP_2$ .
4. For the Yangian the generators would correspond to polynomials of the complex coordinate of string world sheet and for quantum affine algebra to Laurent series for the complex coordinate of partonic 2-surface. What the restriction to polynomials means is not quite clear. Witten sees Yangian as one half of Kac-Moody algebra containing only the generators having  $n \geq 0$ . This might mean that the positivity of conformal weight for physical states essential for the construction of the representations of Virasoro algebra would be replaced with automatic positivity of the conformal weight assignable to the Yangian coordinate.
5. Also Virasoro algebra should be replaced with the Yangian of Virasoro algebra or its quantum counterpart. This construction should generalize also to Super Virasoro algebra. A generalization of conformal field theory to a theory defined at 4-D space-time surfaces using two preferred complex coordinates made possible by surface property is highly suggestive. The generalization of conformal field theory in question would have two complex coordinates and conformal invariance associated with both of them. This would therefore reduce the situation to effectively 2-dimensional one rather than 3-dimensional: this would be nothing but the effective 2-dimensionality of quantum TGD implied by the strong form of General Coordinate Invariance.
6. This picture conforms with what the generalization of  $D = 4 \mathcal{N} = 4$  SYM by replacing point like particles with partonic 2-surfaces would suggest: Yangian is replaced with Yangian of quantum affine algebra rather than quantum group. Note that it is the finite measurement resolution alone which brings in the quantum parameters  $q_1$  and  $q_2$ . The finite measurement resolution might be relevant for the elimination of IR divergences.

### How to construct the Yangian of quantum affine algebra?

The next step is to try to understand the construction of the Yangian of quantum affine algebra.

1. One starts with a given Lie group  $G$ . It could be the group of isometries of the imbedding space or subgroup of it or even the symplectic group of the light-like boundary of  $CD \times CP_2$  and thus infinite-dimensional. It could be also the Lie group defining finite measurement resolution with the dimension of Cartan algebra determined by the number of braid strands.
2. The next step is to construct the affine algebra (Kac-Moody type algebra with central extension). For the group defining the measurement resolution the scalar fields assigned with the ends of braid strands could define the Cartan algebra of Kac-Moody type algebra of this group. The ordered exponentials of these generators would define the charged generators of the affine algebra. For the imbedding space isometries and symplectic transformations the algebra would be obtained by localizing with respect to the internal coordinates of the partonic 2-surface. Note that also a localization with respect to the light-like coordinate of light-cone boundary or light-like orbit of partonic 2-surface is possible and is strongly suggested by the effective 2-dimensionality of light-like 3-surfaces allowing extension of conformal algebra by the dependence on second real coordinate. This second coordinate should obviously correspond to the restriction of second complex coordinate to light-like 3-surface. If the space-time sheets allow slicing by partonic 2-surfaces and string world sheets this localization is possible for all 2-D partonic slices of space-time surface.
3. The next step is quantum deformation to quantum affine algebra with trigonometric R-matrix  $R_{q_1}(u, v)$  associated with space-like braidings along space-like 3-surfaces along the ends of  $CD$ .  $u$  and  $v$  could correspond to the values of a preferred complex coordinate of the geodesic sphere of light-cone boundary defined by rotational symmetry. Its choice would fix a preferred quantization axes for spin.
4. The last step is the construction of Yangian using rational R-matrix  $R_{q_2}(u, v)$ . In this case the braiding is along the light-like orbit between ends of  $CD$ .  $u$  and  $v$  would correspond to the complex coordinates of the geodesic sphere of  $CP_2$ . Now the preferred complex coordinate would fix the quantization axis of color isospin.

These arguments are of course heuristic and do not satisfy any criteria of mathematical rigor and the details could of course change under closer scrutiny. The whole point is in the attempt to understand the situation physically in all its generality.

#### How 4-D generalization of conformal invariance relates to strong form of general coordinate invariance?

The basic objections that one can rise to the extension of conformal field theory to 4-D context come from the successes of p-adic mass calculations. p-Adic thermodynamics relies heavily on the properties of partition functions for super-conformal representations. What happens when one replaces affine algebra with (quantum) Yangian of affine algebra? Ordinary Yangian involves the original algebra and its dual and from these higher multilocal generators are constructed. In the recent case the obvious interpretation for this would be that one has Kac-Moody type algebra with expansion with respect to complex coordinate  $w$  for partonic 2-surfaces and its dual algebra with expansion with respect to hyper-complex coordinate of string world sheet.

p-Adic mass calculations suggest that the use of either algebra is enough to construct single particle states. Or more precisely, local generators are enough. I have indeed proposed that the multilocal generators are relevant for the construction of bound states. Also the strong form of general coordinate invariance implying strong form of holography, effective 2-dimensionality, electric-magnetic duality and S-duality suggests the same. If one could construct the states representing elementary particles solely in terms of either algebra, there would be no danger that the results of p-adic mass calculations are lost. Note that also the necessity to restrict the conformal weights of conformal representations to be non-negative would have nice interpretation in terms of the duality.

## 9.7 More about twistor revolution and TGD

Lubos Motl wrote a nice summary about the talk of Nima Arkani Hamed about twistor revolution in Strings 2012 and gave also a link to the talk [?]. It seems that Nima and collaborators are ending to a

picture about scattering amplitudes which strongly resembles that provided by generalized Feynman diagrammatics in TGD framework

TGD framework is much more general than  $\mathcal{N} = 4$  SYM and is to it same as general relativity for special relativity whereas the latter is completely explicit. Of course, I cannot hope that TGD view could be taken seriously - at least publicly. One might hope that these approaches could be combined some day: both have a lot to give for each other. Below I compare these approaches.

The recent approach below emerges from the study of preferred extremals of Kähler and solutions of the modified Dirac equations so that it begins directly from basic TGD whereas the approaches hitherto have been based on general arguments and the precise role of right-handed neutrino has remained enigmatic. Chapters "Construction of quantum TGD: Symmetries" [?] and "The recent vision about preferred extremals and solutions of the modified Dirac equation" [?] contain section explaining how super-conformal and Yangian algebras crucial for the Grassmannian approach emerge from the basic TGD.

### 9.7.1 The origin of twistor diagrammatics

In TGD framework zero energy ontology forces to replace the idea about continuous unitary evolution in Minkowski space with something more general assignable to causal diamonds (CDs), and S-matrix is replaced with a square root of density matrix equal to a hermitian square root of density matrix multiplied by unitary S-matrix. Also in twistor approach unitarity has ceased to be a star actor. In p-Adic context continuous unitary time evolution fails to make sense also mathematically.

Twistor diagrammatics involves only massless on mass shell particles on both external and internal lines. Zero energy ontology (ZEO) requires same in TGD: wormhole lines carry parallelly moving massless fermions and antifermions. The mass shell conditions at vertices are enormously powerful and imply UV finiteness. Also IR finiteness follows if external particles are massive.

What one means with mass is however a delicate matter. What does one mean with mass? I have pondered 35 years this question and the recent view is inspired by p-adic mass calculations and ZEO, and states that observed mass is in a well-defined sense expectation value of longitudinal mass squared for all possible choices of  $M^2 \subset M^4$  characterizing the choices of quantization axis for energy and spin at the level of "world of classical worlds" (WCW) assignable with given causal diamond  $CD$ .

The choice of quantization axis thus becomes part of the geometry of WCW. All wormhole throats are massless but develop non-vanishing longitudinal mass squared. Gauge bosons correspond to wormhole contacts and thus consist of pairs of massless wormhole throats. Gauge bosons could develop 4-D mass squared but also remain massless in 4-D sense if the throats have parallel massless momenta. Longitudinal mass squared is however non-vanishing and p-adic thermodynamics predicts it.

### 9.7.2 The emergence of 2-D sub-dynamics at space-time level

Nima et al introduce ordering of the vertices in 4-D case. Ordering and related braiding are however essentially 2-D notions. Somehow 2-D theory must be a part of the 4-D theory also at space-time level, and I understood that understanding this is the challenge of the twistor approach at this moment.

The twistor amplitude can be represented as sum over the permutations of  $n$  external gluons and all diagrams corresponding to the same permutation are equivalent. Permutations are more like braidings since they carry information about how the permutation proceeded as a homotopy. Yang-Baxter equation emerges and states associativity of the braid group. The allowed braidings are minimal braidings in the sense that the repetitions of permutations of two adjacent vertices are not considered to be separate. Minimal braidings reduce to ordinary permutations. Nima also talks about affine braidings which I interpret as analogs of Kac-Moody algebras meaning that one uses projective representations which for Kac-Moody algebra mean non-trivial central extension. Perhaps the condition is that the square of a permutation permuting only two vertices which each other gives only a non-trivial phase factor. Lubos suggests an alternative interpretation which would select only special permutations and cannot be therefore correct.

There are rules of identifying the permutation associated with a given diagram involving only basic 3-gluon vertex with white circle and its conjugate. Lubos explains this "Mickey Mouse in maze" rule in his posting in detail: to determine the image  $p(n)$  of vertex  $n$  in the permutation put a mouse in the maze defined by the diagram and let it run around obeying single rule: if the vertex is black turn to the right and if the vertex is white turn to the left. The mouse cannot remain in a loop: if it would

do so, the rule would force it to run back to  $n$  after single full loop and one would have a fixed point:  $p(n) = n$ . The reduction in the number of diagrams is enormous: the infinity of different diagrams reduces to  $n!$  diagrams!

What happens in TGD framework?

1. In TGD framework string world sheets and partonic 2-surfaces (or either or these if they are dual notions as conjectured) at space-time surface would define the sought for 2-D theory, and one obtains indeed perturbative expansion with fermionic propagator defined by the inverse of the modified Dirac operator and bosonic propagator defined by the correlation function for small deformations of the string world sheet. The vertices of twistor diagrams emerge as braid ends defining the intersections of string world sheets and partonic 2-surfaces.

String model like description becomes part of TGD and the role of string world sheets in  $X^4$  is highly analogous to that of string world sheets connecting branes in  $AdS^5 \times S^5$  of  $\mathcal{N} = 4$  SYM. In TGD framework 10-D  $AdS^5 \times S^5$  is replaced with 4-D space-time surface in  $M^4 \times CP_2$ . The meaning of the analog of  $AdS^5$  duality in TGD framework should be understood. In particular, it could it be that the descriptions involving string world sheets on one hand and partonic 2-surfaces - or 3-D orbits of wormhole throats defining the generalized Feynman diagram- on the other hand are dual to each other. I have conjectured something like this earlier but it takes some time for this kind of issues to find their natural answer.

2. As described in the article, string world sheets and partonic 2-surfaces emerge directly from the construction of the solutions of the modified Dirac equation by requiring conservation of em charge. This result has been conjectured already earlier but using other less direct arguments. 2-D "string world sheets" as sub-manifolds of the space-time surface make the ordering possible, and guarantee the finiteness of the perturbation theory involving n-point functions of a conformal QFT for fermions at wormhole throats and n-point functions for the deformations of the space-time surface. Conformal invariance should dictate these n-point functions to a high degree. In TGD framework the fundamental 3-vertex corresponds to joining of light-like orbits of three wormhole contacts along their 2-D ends (partonic 2-surfaces).

### 9.7.3 The emergence of Yangian symmetry

Yangian symmetry associated with the conformal transformations of  $M^4$  is a key symmetry of Grassmannian approach. Is it possible to derive it in TGD framework?

1. TGD indeed leads to a concrete representation of Yangian algebra as generalization of color and electroweak gauge Kac-Moody algebra using general formula discussed in Witten's article about Yangian algebras (see the article).
2. Article discusses also a conjecture about 2-D Hodge duality of quantized YM gauge potentials assignable to string world sheets with Kac-Moody currents. Quantum gauge potentials are defined only where they are needed - at string world sheets rather than entire 4-D space-time.
3. Conformal scalings of the effective metric defined by the anticommutators of the modified gamma matrices emerges as realization of quantum criticality. They are induced by critical deformations (second variations not changing Kähler action) of the space-time surface. This algebra can be generalized to Yangian using the formulas in Witten's article (see the article).
4. Critical deformations induce also electroweak gauge transformations and even more general symmetries for which infinitesimal generators are products of  $U(n)$  generators permuting  $n$  modes of the modified Dirac operator and infinitesimal generators of local electro-weak gauge transformations. These symmetries would relate in a natural manner to finite measurement resolution realized in terms of inclusions of hyperfinite factors with included algebra taking the role of gauge group transforming to each other states not distinguishable from each other.
5. How to end up with Grassmannian picture in TGD framework? This has inspired some speculations in the past. From Nima's lecture one however learns that Grassmannian picture emerges as a convenient parametrization. One starts from the basic 3-gluon vertex or its conjugate expressed in terms of twistors. Momentum conservation implies that with the three twistors  $\lambda_i$

or their conjugates are proportional to each other (depending on which is the case one assigns white or black dot with the vertex). This constraint can be expressed as a delta function constraint by introducing additional integration variables and these integration variables lead to the emergence of the Grassmannian  $G_{n,k}$  where  $n$  is the number of gluons, and  $k$  the number of positive helicity gluons.

Since only momentum conservation is involved, and since twistorial description works because only massless on mass shell virtual particles are involved, one is bound to end up with the Grassmannian description also in TGD.

### 9.7.4 The analog of $AdS^5$ duality in TGD framework

The generalization of  $AdS^5$  duality of  $\mathcal{N} = 4$  SYMs to TGD framework is highly suggestive and states that string world sheets and partonic 2-surfaces play a dual role in the construction of M-matrices. Some terminology first.

1. Let us agree that string world sheets and partonic 2-surfaces refer to 2-surfaces in the slicing of space-time region defined by Hermitian structure or Hamilton-Jacobi structure.
2. Let us also agree that *singular* string world sheets and partonic 2-surfaces are surfaces at which the *effective* metric defined by the anticommutators of the modified gamma matrices degenerates to effectively 2-D one.
3. Braid strands at wormhole throats in turn would be loci at which the *induced* metric of the string world sheet transforms from Euclidian to Minkowskian as the signature of induced metric changes from Euclidian to Minkowskian.

$AdS^5$  duality suggest that string world sheets are in the same role as string world sheets of 10-D space connecting branes in  $AdS^5$  duality for  $\mathcal{N} = 4$  SYM. What is important is that there should exist a duality meaning two manners to calculate the amplitudes. What the duality could mean now?

1. Also in TGD framework the first manner would be string model like description using string world sheets. The second one would be a generalization of conformal QFT at light-like 3-surfaces (allowing generalized conformal symmetry) defining the lines of generalized Feynman diagram. The correlation functions to be calculated would have points at the intersections of partonic 2-surfaces and string world sheets and would represent braid ends.
2. General Coordinate Invariance (GCI) implies that physics should be codable by 3-surfaces. Light-like 3-surfaces define 3-surfaces of this kind and same applies to space-like 3-surfaces. There are also preferred 3-surfaces of this kind. The orbits of 2-D wormhole throats at which 4-metric degenerates to 3-dimensional one define preferred light-like 3-surfaces. Also the space-like 3-surfaces at the ends of space-time surface at light-like boundaries of causal diamonds (CDs) define preferred space-like 3-surfaces. Both light-like and space-like 3-surfaces should code for the same physics and therefore their intersections defining partonic 2-surfaces plus the 4-D tangent space data at them should be enough to code for physics. This is strong form of GCI implying effective 2-dimensionality. As a special case one obtains singular string world sheets at which the effective metric reduces to 2-dimensional and singular partonic 2-surfaces defining the wormhole throats. For these 2-surfaces situation could be especially simple mathematically.
3. The guess inspired by strong GCI is that string world sheet -partonic 2-surface duality holds true. The functional integrals over the deformations of 2 kinds of 2-surfaces should give the same result so that functional integration over either kinds of 2-surfaces should be enough. Note that the members of a given pair in the slicing intersect at discrete set of points and these points define braid ends carrying fermion number. Discretization and braid picture follow automatically.
4. Scattering amplitudes in the twistorial approach could be thus calculated by using *any* pair in the slicing - or only either member of the pair if the analog of  $AdS^5$  duality holds true as argued. The possibility to choose any pair in the slicing means general coordinate invariance as a symmetry of the Kähler metric of WCW and of the entire theory suggested already early: Kähler



functions for difference choices in the slicing would differ by a real part of holomorphic function and give rise to same Kähler metric of "world of classical worlds" (WCW). For a general pair one obtains functional integral over deformations of space-time surface inducing deformations of 2-surfaces with only other kind 2-surface contributing to amplitude. This means the analog of stringy QFT: Minkowskian or Euclidian string theory depending on choice.

5. For singular string world sheets and partonic 2-surfaces an enormous simplification results. The propagators for fermions and correlation functions for deformations reduce to 1-D instead of being 2-D: the propagation takes place only along the light-like lines at which the string world sheets with Euclidian signature (inside  $CP_2$  like regions) change to those with Minkowskian signature of induced metric. The local reduction of space-time dimension would be very real for particles moving along sub-manifolds at which higher dimensional space-time has reduced metric dimension: they cannot get out from lower-D sub-manifold. This is like ending down to 1-D black hole interior and one would obtain the analog of ordinary Feynman diagrammatics. This kind of Feynman diagrammatics involving only braid strands is what I have indeed ended up earlier so that it seems that I can trust good intuition combined with a sloppy mathematics sometimes works;-).

These singular lines represent orbits of point like particles carrying fermion number at the orbits of wormhole throats. Furthermore, in this representation the expansions coming from string world sheets and partonic 2-surfaces are identical automatically. This follows from the fact that only the light-like lines connecting points common to singular string world sheets and singular partonic 2-surfaces appear as propagator lines!

6. The TGD analog of AdS<sup>5</sup> duality of  $\mathcal{N} = 4$  SUSYs would be trivially true as an identity in this special case, and the good guess is that it is true also generally. One could indeed use integral over either string world sheets or partonic 2-sheets to deduce the amplitudes.

What is important to notice that singularities of Feynman diagrams crucial for the Grassmannian approach of Nima and others would correspond at space-time level 2-D singularities of the effective metric defined by the modified gamma matrices defined as contractions of canonical momentum currents for Kähler action with ordinary gamma matrices of the imbedding space and therefore directly reflecting classical dynamics.

### 9.7.5 Problems of the twistor approach from TGD point of view

Twistor approach has also its problems and here TGD suggests how to proceed. Signature problem is the first problem.

1. Twistor diagrammatics works in a strict mathematical sense only for  $M^{2,2}$  with metric signature (1,1,-1,-1) rather than  $M^4$  with metric signature (1,-1,-1,-1). Metric signature is wrong in the physical case. This is a real problem which must be solved eventually.
2. Effective metric defined by anticommutators of the modified gamma matrices (to be distinguished from the induced gamma matrices) could solve that problem since it would have the correct signature in TGD framework (see the article). String world sheets and partonic 2-surfaces would correspond to the 2-D singularities of this effective metric at which the even-even signature (1,1,1,1) changes to even-even signature (1,1,-1,-1). Space-time at string world sheet would become locally 2-D with respect to effective metric just as space-time becomes locally 3-D with respect to the induced metric at the light-like orbits of wormhole throats. String world sheets become also locally 1-D at light-like curves at which Euclidian signature of world sheet in induced metric transforms to Minkowskian.
3. Twistor amplitudes are indeed singularities and string world sheets implied in TGD framework by conservation of em charge would represent these singularities at space-time level. At the end of the talk Nima conjectured about lower-dimensional manifolds of space-time as representation of space-time singularities. Note that string world sheets and partonic 2-surfaces have been part of TGD for years. TGD is of course to  $\mathcal{N} = 4$  SYM what general relativity is for the special relativity. Space-time surface is dynamical and possesses induced and effective metrics rather than being flat.

Second limitation is that twistor diagrammatics works only for planar diagrams. This is a problem which must be also fixed sooner or later.

1. This perhaps dangerous and blasphemous statement that I will regret it some day but I will make it;-). Nima and others have not yet discovered that  $M^2 \subset M^4$  must be there but will discover it when they begin to generalize the results to non-planar diagrams and realize that Feynman diagrams are analogous to knot diagrams in 2-D plane (with crossings allowed) and that this 2-D plane must correspond to  $M^2 \subset M^4$ . The different choices of causal diamond  $CD$  correspond to different choices of  $M^2$  representing choice of quantization axes 4-momentum and spin. The integral over these choices guarantees Lorentz invariance. Gauge conditions are modified: longitudinal  $M^2$  projection of massless four-momentum is orthogonal to polarization so that three polarizations are possible: states are massive in longitudinal sense.
2. In TGD framework one replaces the lines of Feynman diagrams with the light-like 3-surfaces defining orbits of wormhole throats. These lines carry many fermion states defining braid strands at light-like 3-surfaces. There is internal braiding associated with these braid strands. String world sheets connect fermions at different wormhole throats with space-like braid strands. The  $M^2$  projections of generalized Feynman diagrams with 4-D "lines" replaced with genuine lines define the ordinary Feynman diagram as the analog of braid diagram. The conjecture is that one can reduce non-planar diagrams to planar diagrams using a procedure analogous to the construction of knot invariants by un-knotting the knot in Alexandrian manner by allowing it to be cut temporarily.
3. The permutations of string vertices emerge naturally as one constructs diagrams by adding to the interior of polygon sub-polygons connected to the external vertices. This corresponds to the addition of internal partonic two-surfaces. There are very many equivalent diagrams of this kind. Only permutations matter and the permutation associated with a given diagram of this kind can be deduced by the Mickey-Mouse rule described explicitly by Lubos. A connection with planar operads is highly suggestive and also conjecture already earlier in TGD framework.

### 9.7.6 Still one attempt understand generalized Feynman diagrams

The only manner to develop the understanding about generalized Feynman diagrams is to articulate the basic questions again and again in the hope that something new might emerge. There are many questions to be answered.

What Grassmannian twistorialization means when imbedding space spinor fields are the fundamental objects. How does ZEO make twistorialization possible? How twistorialization emerges from the functional integral in WCW from the proposed stringy construction of spinor modes.

One must also understand in detail the realization of super-conformal symmetries and how  $n$ -point functions of conformal field theory are associated with scattering amplitudes, and how cm degrees of freedom described using imbedding space spinor harmonics are treated in the scattering amplitudes. Also the braiding and knotting should be understood. The challenge is to find a universal form for the vertices and to identify the propagators. Also the modular degrees of freedom of partonic 2-surfaces explaining family replication phenomenon should be taken into account.

### Zero energy ontology, twistors, and Grassmannian description?

In ZEO also virtual wormhole throats are massless particles and four-momentum conservation at vertices identifiable as partonic 2-surfaces at which wormhole throats meet expressed in terms of twistors leads to Grassmannian formulation automatically. This feature is thus not specific to  $\mathcal{N} = 4$  SYM.

Momentum conservation and massless on mass-shell conditions at vertices defined as partonic 2-surfaces at which the orbits of wormhole contacts meet, are extremely restrictive, and one has good hopes that huge reduction in the number of twistorial diagrams takes place and could even lead to finite number of diagrams (number theoretic arguments favor this).

### Realization of super-conformal algebra

Thanks to the advances in the construction of preferred extremals and solutions of the modified Dirac equation there has been considerable progress in the understanding of super-conformal invariance and its 4-D generalization [?].

1. In ordinary SYM ground states correspond to both maximal helicities or only second maximal helicity of super multiplet ( $\mathcal{N} = 4$  case). Now these ground states are replaced by the modes of imbedding space spinor fields assignable to center of mass degrees of freedom for partonic 2-surfaces. The light-like four-momenta of these modes can be expressed in terms of twistor variables. Spin-statistics connection seems to require that the total number of fermions and antifermions associated with given wormhole throat is always odd.
2. Super-algebra consists of oscillator operators with non-vanishing quark or lepton number. By conformal invariance fermionic oscillator operators obey 1-D anti-commutation relations. The integral over  $CD$  boundary defines a bi-linear form analogous to inner product. If a reduction to single particle level takes place, the vertex is expressible as a matrix element between two fermion-anti-fermion states: the first one assignable to the incoming and outgoing wormhole throats one and second to the virtual boson identified as wormhole contact on one hand. The exchange boson entangled fermion-anti-fermion state represented by a bi-local generalization of the gauge current. This picture applying to gauge boson exchanges generalizes in rather obvious manner.
3. Unitarity demands correlation between fermionic oscillator operators and spinor harmonics of imbedding space as following argument suggests. The bilocal generalization of gauge current defines a "norm" for spinor modes as generalization of what in QFT regarded as charge. On basis of experience with Dirac spinors one expect that this norm is not positive definite. This "norm" must be consistent with the unitarity of the scattering amplitude and the experience with QFT suggests a correlation between creation/annihilation operator character of fermionic oscillator operators and the sign of the "norm" in imbedding space degrees of freedom.
4. The modes with negative norm should correspond to negative energy fermions and annihilation operators and modes with positive norm to positive energy fermions and creation operators. Therefore the anti-commutators of fermionic oscillator operators must be linear in four-momentum or its longitudinal projection and thus proportional to  $p^k \gamma_k$  or  $p_L^k \gamma_k$ .

On the other hand, the primary anti-commutators for the induced spinor fields are proportional to the modified gamma matrix in a direction normal to the 1-D quantization curve at the boundary of string world sheet or at the partonic 2-surface. These two anti-commutators should be consistent.

- (a) Does the functional integral somehow lead from the primordial anti-commutators to the anti-commutators involving longitudinal momentum and perhaps 1-D delta function in the intersection of  $M^2$  with  $CD$  boundary (light-like line)?
- (b) Or does the connection between the two quantizations emerge as boundary conditions stating that the normal component of modified gamma matrix at the boundary and along string world sheet equals to  $p_L^k \gamma_k$ ? This would also realize quantum classical correspondence in the sense that the longitudinal momentum is reflected in the geometry of the space-time sheet. Quaternionic space-time surfaces indeed contain integrable distribution of  $M^2(x) \subset M^4$  at their tangent spaces. The restriction to braid strands would mean that the condition indeed makes sense. Note that braid strands should correspond to same  $M^2(x)$ .

### How conformal time evolution corresponds to physical time evolution?

The only internally consistent option is conformally invariant meaning that induced spinor fields anti-commute only along as set of 1-D curves belonging to partonic 2-surfaces. This means that one can speak about conformal time evolution at partonic 2-surface.

This suggests a huge simplification of the conformal dynamics.

1. Conformal time evolution can be translated to time evolution along light-like orbit of wormhole throat by projecting the intersections of this surface with shifted light-cone boundary to the upper or lower light-like boundary of  $CD$ : whether it is upper or lower boundary of  $CD$  depends on the arrow of imbedding space time associated with the zero energy state. All partonic 2-surfaces would be mapped to same light-cone boundary. The orbits of braid strands at wormhole throat project to orbits at light-cone boundary in question and can be further projected to the sphere  $r_M = \text{constant}$  at light-boundary. 3-D dynamics would project to simplest possible stringy 2-D dynamics (spherical string orbit) and dictated by conformal invariance.
2. The conformal field theory in question is for conformal fermionic fields realized in terms of fermionic oscillator operators and  $n$ -point functions correspond to fermionic  $n$ -point functions. The non-triviality of dynamics in these degrees of freedom follows from the non-triviality of the conformal field theory. The entire collection of partonic 2-surfaces at the ends of  $CD$  would reduce to its projection to  $S^2$ .
3. One can try to build a geometric view about the situation using as a guideline conformal Hamiltonian quantum evolution. Time=constant slices would correspond to 1-D curve or collection of them. At these slices fermionic oscillator operators would satisfy the conformal anti-commutation relations. This kind of slice would be associated with both ends of  $CD$ . Braid strands would connect these 1-D slices as kind of hairs. One can however ask whether there is any need to restrict the end points of braid strands to line on a curve at which fermionic oscillator operators satisfy stringy anti-commutation relations.

### What happens in 3-vertices?

The vision is that only 3-vertices are needed. Idealize particles as wormhole contacts (in reality pair of wormhole contacts connected by a flux tube would describe elementary particles). A very convenient visualization of wormhole contact is as a very short string like object with throats at its ends so that stringy diagrammatics allows to identify the vertices as the analogs of open string vertices. One can even consider the possibility that string theory amplitudes define the vertices. This would conform with the p-adic mass calculations applying conformal invariance in  $CP_2$  scale. Note also that partonic 2-surfaces are effectively replaced by braids so that very stringy picture results.

1. Consider a three vertex representing the emission of boson by incoming fermion (FFB) or by incoming boson (BBB) described as wormhole contact such that throats carry fermion and anti-fermion number in the bosonic case. In the fermionic the first throat carries fermion and second one represents vacuum state. The exchanged boson can be regarded as fermion anti-fermion pair such that second fermion travels to future and second one to the past in the vertex. 3-vertex would reduce to two 2-vertices representing the transformation of fermion line from incoming line to exchanged line or from latter to outgoing line.
2. The minimal option is that the same vertex describes the situation if both cases. Essentially a combination of incoming free fermions to boson like state is in question and corresponds in string picture an exchange of open string between open strings. If so, second wormhole throat is passive and suffers forward scattering in the vertex. The fermion and anti-fermion of the exchanged virtual boson (the light-like momenta of wormhole throats need not be collinear for virtual bosons and also the sign of energy can be different from them) would suffer scattering before the transformation to fermions belonging to incoming and outgoing wormhole contact.

One expects the vertices to factorize into products of two kinds of factors: the inner products of fermionic Fock states defined by conformal  $n$ -point functions at sphere of light-cone boundary, and the bi-linear forms for the modes of imbedding space spinor fields involving integral over cm degrees of freedom and allowing twistorialization by previous arguments. Let us continue with the simple example in which wormhole throats carry fermion number 0 or 1.

1. If second wormhole throat is passive, it is enough to construct only FFB vertex, with B identified as a wormhole contact carrying fermion and anti-fermion. One has 4 fermions altogether, and one expects that in cm degrees of freedom incoming and outgoing fermion are un-correlated whereas the fermions of the boson exchange are correlated and the correlation is expressible as the analog of gauge current.

2. This suggests a sum over bi-local counterparts of electro-weak and color gauge currents at opposite ends of the exchanged line. Bi-local gauge currents would contain a spinor mode from both wormhole throats, and the strict locality of  $M^4$  gauge currents would be replaced with a bi-locality in  $CP_2$  scale.
3. The current assignable to a particular boson exchange must involve the matrix element of corresponding charge matrix between spinor modes besides the quantity. Is it possible to find a general expression for the sum over current - current interaction terms? If this is the case, there would be no need to perform the summation over bosonic exchanges explicitly. One would have the analog for the  $\sum_n |n\rangle\langle n|$  in propagator line but summation allowing the momenta of fermion and antifermion to be arbitrary massless momenta rather than summing up to the on mass shell momentum of boson. The counterpart of gauge coupling should be universal and naturally given by Kähler coupling.
4. The TGD counterparts of scalar and pseudo-scalar bosons would be vector bosons with polarization in  $CP_2$  direction and they could be also seen both as Higgs like states and Euclidian pions assignable to wormhole contacts. Genuine  $H$ -scalars are excluded implied by 8-D chiral symmetry implying also separate conservation of  $B$  and  $L$ .

In the general case the wormhole throats carry arbitrary odd fermion number but for fermion numbers  $n > 1$  at any wormhole throat exotic super-partner with propagator decaying faster than  $1/p^2$  is in question. Furthermore, wormhole contact is accompanied by second wormhole contact since the flux lines of monopole flux must closed. Therefore one has a pair of "long" string like flux tubes connected by short flux tubes at their ends. Its length is given by weak length scale quite generally or possibly by Compton length. The other end of the long flux tube can also contain fermions at both flux tubes.

### The identification of propagators

A natural guess is that the propagator for single fermion state is just the longitudinal Dirac propagator  $D_{p_L}$  for a massless fermion in  $M^4 \supset M^2$ . For states, which by statistics constraint always contain an odd number  $M = 2N + 1$  of fermions and antifermions, the propagator would be  $M$ :th power of fermionic longitudinal propagator so that it would reduce to  $p_L^{-2N} D_{p_L}$  meaning that only the single fermion states would behave like ordinary elementary particles. States with higher fermion number would represent radiative corrections reflecting the non-point-like nature of partons. Longitudinal mass squared would be equal to the sum of the contribution from  $CP_2$  degrees of freedom and the integer valued conformal contribution from spinor harmonics. The  $M^4$  momenta associated with wormhole throats would be light-like. In the prescription using fermionic longitudinal propagators assigned to the braid strands, braid strands are analogous to the edges of polygons appearing in twistor Grassmannian approach.

### Some open questions

A long list of open questions remains without a final answer. Consider first twistor Grassmannian approach.

1. Does this prescription follow from quantum criticality? Recall that quantum criticality formulated in terms of preferred extremals and modified Dirac equation leads to a stringy perturbation theory involving fermionic propagator defined by the modified Dirac operator and functional integral over WCW for the deformations of space-time surface preserving the preferred extremal property [?]. This propagator could be called space-time propagator to distinguish it from the imbedding space propagator associated with the longitudinal momentum.
2. One expects that one still has topological Feynman diagrammatic expansion (besides that defined by functional integral over small deformations of space-time surface with given topology) involving in principle an arbitrary number of vertices defined by the intermediate partonic 2-surfaces. Momentum conservation and massless on mass-shell conditions however pose powerful restrictions on the allowed diagrams, and one might hope that the simplicity of the outcome is comparable to Grassmannian twistor approach for  $\mathcal{N} = 4$  SYM. One can even hope that the

number of contributing diagrams is finite. The important point would be that Grassmannian diagrams would give the outcome of the functional integral over 3-surfaces. Twistorial Grassmann representation is the first guess hitherto for the explicit outcome of the functional integral over WCW.

3. The lines of Feynman graph are replaced with braids. A new element is that braid strands are braided as curves inside light-like 3-surfaces defined by the orbit of the wormhole throat. Twistorial construction applies only to the planar amplitudes of  $\mathcal{N} = 4$  SYM. Can one imagine TGD counterparts for non-planar amplitudes in TGD framework or does the stringy picture imply that they are completely absent?

A possible answer to the question is based on the  $M^2$  projection of the lines of braid strands (or on the projection to the 2-surface defined by an integrable distribution of tangent planes  $M^2(x)$ ). For non-planar diagrams the projections intersect and the intersection cannot be eliminated by a small deformation. It does not make sense to say that line goes over or below the second line. One can speak only about crossings. In the theory of algebraic knots [?] algebraic knots with crossings are possible [?]. Could algebraic knot theory allow to reduce non-planar diagrams to sums of planar diagrams?

4. Does one obtain Yangian symmetry using longitudinal propagators and by integrating over the moduli labeling among other things the choices of the preferred plane  $M^2 \subset M^4$  or integrable distribution of preferred planes  $M^2(x) \subset M^4$ ? The integral over the choices  $M^2 \subset M^4$  gives formally a Lorentz invariant outcome. Does it also give rise to physically acceptable scattering amplitudes? Are the gauge conditions for the incoming gauge boson states formulated in terms of longitudinal momentum and thus allowing also the third polarization physical? Can one apply this gauge condition also to the virtual boson like exchanges?
5. It is still somewhat unclear whether one should assume single global choice of  $M^2$  or an integrable distribution of  $M^2(x)$ .

- (a) The choice of  $M^2(x)$  must be same for all braid strands of given partonic 2-surface and remain constant along braid strand and therefore be same also at second end of the strand. Otherwise the fermionic propagator would vary along braid strand. A possible additional condition on braids is that braid strands correspond to the same choice of  $M^2(x)$ . In quantum measurement theory this corresponds to the choice of same spin quantization axes for all fermions inside parton and is physically extremely natural condition. The implication is that one can indeed assign a fixed  $M^2$  with  $CD$  and choice of braid strands via boundary conditions. The simplest boundary conditions would require  $M^2(x)$  to be constant at light-like 3-surfaces and at the ends of space-time surface at boundaries of  $CD$ . This is in spirit with holography stating that quantum measurements can be carried out only at these 3-surfaces (or at least those at the ends of  $CD$ ).
- (b) One cannot exclude the possibility that  $M^2(x)$  does not depend on  $x$  for a particular space-time sheet and even entire  $CD$  although this looks rather strong a restriction. On the other hand, one can ask whether the preferred  $M^2$  assigned with  $CD$  should be generalized to an integrable distribution  $M^2(x)$  assigned with  $CD$  such that  $M^2(x)$  is contained in the tangent space of preferred Minkowskian extremal.
- (c) Is the functional integral over integrable distributions  $M^2(x)$  needed? It would be analogous to a functional integral over string world sheets. It is enough to integrate over Lorentz transforms of a given distribution  $M^2(x)$  to achieve Lorentz invariance. This because the choice of the integrable distribution of  $M^2(x)$  for space-time surface reduces effectively to the choice of  $M^2$  for the disconnected pieces of generalized Feynman diagram. Physical intuition suggests that a particular choice of  $M^2(x)$  corresponds to fixing of zero modes of WCW and is essentially fixing of classical variables needed to fix quantization axes. The fixing of value distributions of induced Kähler fields in 4-D sense at partonic 2-surfaces would be similar fixation of zero modes.
- (d) If only  $M^2$  momentum makes it visible in anti-commutators, how the other components of four-momentum can make themselves visible in dynamics? This is possible via momentum conservation at vertices making possible twistor Grassmannian approach. The dynamics in transversal momenta would be dictated completely by the conservation laws.

There are also other challenges.

1. Family replication phenomenon has TGD based explanation in terms of the conformal moduli of partonic 2-surfaces. How conformal moduli should be taken into account in the Feynman diagrammatics? Phenomena like topological mixing inducing in turn the mixing of partonic 2-topologies responsible for CKM mixing in TGD Universe should be understood in this description.
2. Number theoretical universality requires that also the p-adic variants of the amplitudes should make sense. One could even require that the amplitudes decompose to products of parts belonging to different number fields [?]. If one were able to formulate this vision precisely, it would provide powerful constraints on the amplitudes. For instance, a reduction of the amplitudes to a sum over finite number of generalized Feynman diagrams is plausible since this would guarantee that individual contributions which must give rise to algebraic numbers for algebraic 4-momenta, would sum up to an algebraic number.

## 9.8 Does the exponent of Chern-Simons action reduce to the exponent of the area of minimal surfaces?

As I scanned of hep-th I found an interesting article by Giordano, Peschanski, and Seki [?] based on AdS/CFT correspondence. What is studied is the high energy behavior of the gluon-gluon and quark-quark scattering amplitudes of  $\mathcal{N} = 4$  SUSY.

1. The proposal made earlier by Aldaya and Maldacena [?] is that gluon-gluon scattering amplitudes are proportional to the imaginary exponent of the area of a minimal surface in  $AdS_5$  whose boundary is identified as *momentum space*. The boundary of the minimal surface would be polygon with light-like edges: this polygon and its dual are familiar from twistor approach.
2. Giordano, Peschanski, and Seki claim that quark-quark scattering amplitude for heavy quarks corresponds to the exponent of the area for a minimal surface in the *Euclidian* version of  $AdS_5$  which is hyperbolic space (space with a constant negative curvature): it is interpreted as a counterpart of configuration space rather than momentum space and amplitudes are obtained by analytic continuation. For instance, a universal Regge behavior is obtained. For general amplitudes the exponent of the area alone is not enough since it does not depend on gluon quantum numbers and vertex operators at the edges of the boundary polygon are needed.

In the following my intention is to consider the formulation of this conjecture in quantum TGD framework. I hasten to inform that I am not a specialist in AdS/CFT and can make only general comments inspired by analogies with TGD.

### 9.8.1 Why Chern-Simons action should reduce to area for minimal surfaces?

The minimal surface conjectures are highly interesting from TGD point of view. The weak form of electric magnetic duality implies the reduction of Kähler action to 3-D Chern-Simons terms. Effective 2-dimensionality implied by the strong form of General Coordinate Invariance suggests a further reduction of Chern-Simons terms to 2-D terms and the areas of string world sheet and of partonic 2-surface are the only non-topological options that one can imagine. Skeptic could of course argue that the exponent of the minimal surface area results as a characterizer of the quantum state rather than vacuum functional. In the following I defend the minimal interpretation as Chern-Simons terms.

Let us look this conjecture in more detail.

1. In zero energy ontology twistor approach is very natural since all physical states are bound states of massless particles. Also virtual particles are composites of massless states. The possibility to have both signs of energy makes possible space-like momenta for wormhole contacts. Mass shell conditions at internal lines imply extremely strong constraints on the virtual momenta and both UV and IR finiteness are expected to hold true.

2. The weak form of electric magnetic duality [?] implies that the exponent of Kähler action reduces to the exponent of Chern-Simons term for 3-D space-like surfaces at the ends of space-time surface inside  $CD$  and for light-like 3-surfaces. The coefficient of this term is complex since the contribution of Minkowskian regions of the space-time surface is imaginary ( $\sqrt{g_4}$  is imaginary) and that of Euclidian regions (generalized Feynman diagrams) real. The Chern-Simons term from Minkowskian regions is like Morse function and that from Euclidian regions defines Kähler function and stationary phase approximation makes sense. The two contributions differ only by imaginary coefficient if Chern-Simons term contains only contributions from wormhole throats and ends of space-time at  $CD$ s. This need not be the case.
3. Electric magnetic duality [?] leads also to the conclusion that wormhole throats carrying elementary particle quantum numbers are Kähler magnetic monopoles. This forces to identify elementary particles as string like objects with ends having opposite monopole charges. Also more complex configurations are possible.

It is not quite clear what the scale of the stringyness is. The natural first guess inspired by quantum classical correspondence is that it corresponds to the p-adic length scale of the particle characterizing its Compton length. Second possibility is that it corresponds to electroweak scale. For leptons stringyness in Compton length scale might not have any fatal implications since the second end of string contains only neutrinos neutralizing the weak isospin of the state. This kind of monopole pairs could appear even in condensed matter scales: in particular if the proposed hierarchy of Planck constants [K25] is realized.

4. Strong form of General Coordinate Invariance requires effective 2-dimensionality. In given UV and IR resolutions either partonic 2-surfaces or string world sheets form a finite hierarchy of  $CD$ s inside  $CD$ s with given  $CD$  characterized by a discrete scale coming as an integer multiple of a fundamental scale (essentially  $CP_2$  size). The string world sheets have boundaries consisting of either light-like curves in induced metric at light-like wormhole throats and space-like curves at the ends of  $CD$  whose  $M^4$  projections are light-like. These braids intersect partonic 2-surfaces at discrete points carrying fermionic quantum numbers.

This implies a rather concrete analogy with  $AdS_5 \times S_5$  duality, which describes gluons as open strings. In zero energy ontology (ZEO) string world sheets are indeed a fundamental notion and the natural conjecture is that these surfaces are minimal surfaces whose area by quantum classical correspondence depends on the quantum numbers of the external particles. String tension in turn should depend on gauge couplings -perhaps only Kähler coupling strength- and geometric parameters like the size scale of  $CD$  and the p-adic length scale of the particle.

5. Are the minimal surfaces in question minimal surfaces of the imbedding space  $M^4 \times CP_2$  or of the space-time surface  $X^4$ ? All possible 2-surfaces at the boundary of  $CD$  must be allowed so that they cannot correspond to minimal surfaces in  $M^4 \times CP_2$  unless one assumes that they emerge in stationary phase approximation only. The boundary conditions at the ends of  $CD$  could however be such that *any* partonic 2-surface correspond to a minimal surfaces in  $X^4$ . Same applies to string world sheets. One might even hope that these conditions combined with the weak form of electric magnetic duality fixes completely the boundary conditions at wormhole throats and space-like ends of space-time surface.

The trace of the second fundamental form orthogonal to the string world sheet/partonic 2-surface as sub-manifold of space-time surface would vanish: this is nothing but a generalization of the geodesic motion obtained by replacing word line with a 2-D surface. It does not imply the vanishing of the trace of the second fundamental form in  $M^4 \times CP_2$  having interpretation as a generalization of particle acceleration [K77]. Effective 2-dimensionality would be realized if Chern-Simons terms reduce to a sum of the areas of these minimal surfaces.

These arguments suggest that scattering amplitudes are proportional to the product of exponents of 2-dimensional actions which can be either imaginary or real. Imaginary exponent would be proportional to the total area of string world sheets and the imaginary unit would come naturally from  $\sqrt{g_2}$ . Teal exponent proportional to the total area of partonic 2-surfaces. The coefficient of these areas would not in general be same.

The equality of the Minkowskian and Euclidian Chern-Simons terms is suggestive but not necessarily true since there could be also other Chern-Simons contributions than those assignable to



wormhole throats and the ends of space-time. The equality would imply that the total area of string world sheets equals to the total area of partonic 2-surfaces suggesting strongly a duality meaning that either Euclidian or Minkowskian regions carry the needed information.

### 9.8.2 IR cutoff and connection with p-adic physics

In twistor approach the IR cutoff is necessary to get rid of IR divergences. Also in the  $AdS_5$  approach the condition that the minimal surface area is finite requires an IR cutoff. The problem is that there is no natural IR cutoff. In TGD framework zero energy ontology brings in a natural IR cutoff via the finite and quantized size scale of  $CD$  guaranteeing that the minimal surfaces involved have a finite area. This implies that also particles usually regarded as massless have a small mass characterized by the size of  $CD$ . The size scale of  $CD$  would correspond to the scale parameter  $R$  assigned with the metric of  $AdS_5$ .

1. String tension relates in  $AdS_5$  approach to the gauge coupling  $g_{YM}$  and to the number  $N_c$  of colors by the formula

$$\lambda = g_{YM}^2 N_c = \frac{R^2}{\alpha'} . \quad (9.8.1)$$

$1/N_c$ -expansion is in terms of  $1/\sqrt{\lambda}$ . The formula has an alternative form as an expression for the string tension

$$\alpha' = \frac{R^2}{\sqrt{g_{YM}^2 N_c}} . \quad (9.8.2)$$

The analog this formula in TGD framework suggests an connection with p-adic length scale hypothesis.

1. As already noticed, the natural counterpart for the scale  $R$  could be the discrete value of the size scale of  $CD$ . Since the symplectic group assignable to  $\delta M_{\pm}^4 \times CP_2$  (or the upper or lower boundary of  $CD$ ) is the natural generalization of the gauge group, it would seem that  $N_c = \infty$  holds true in the absence of cutoff. At the limit  $N_c = \infty$  only planar diagrams would contribute to YM scattering amplitudes. Finite measurement resolution must make the effective value of  $N_c$  finite so that also  $\lambda$  would be finite. String tension would depend on both the size of  $CD$  and the effective number of symplectic colors.
2. If  $\alpha'$  is characterized by the square of the Compton length of the particle,  $\lambda$  would be essentially the square of the ratio of  $CD$  size scale given by secondary p-adic lengths and of the primary p-adic length scale associated with the particle:  $\lambda = g_{YM}^2 \sqrt{p}$ , where  $p$  is the p-adic prime characterizing the particle. Favored values of the p-adic prime correspond to primes near powers of two. The effective number of symplectic colors would be  $N_c = \sqrt{p}/g_{YM}^2$  and the expansion would come in powers of  $g_{YM}^2/\sqrt{p}$ . For electron one would have  $p = M_{127} = 2^{127-1}$  so that the expansion would converge extremely fast. Together with the amazing success of the p-adic mass calculations based on p-adic thermodynamics for the scaling generator  $L_0$  [K45] this suggests a deep connection with p-adic physics and number theoretic universality.

### 9.8.3 Could Kähler action reduce to Kähler magnetic flux over string world sheets and partonic 2-surfaces?

Can one consider alternative identifications of Kähler action for preferred extremals? The only alternative identification of Kähler function that I can imagine is that Kähler action proportional to the Kähler magnetic flux  $\int_{Y^2} J$  or Kähler electric flux  $\int_{Y^2} *J$  for string world sheets and possibly also partonic 2-surfaces. These fluxes are dimensionless numbers. If the weak form of electric-magnetic duality holds true also at string world sheets, the two options are equivalent apart from a proportionality constant.

1. For Kähler magnetic flux there would be no explicit dependence on the induced metric. This is in accordance with the almost topological QFT property.
2. Unless the weak form of electric-magnetic duality holds true, the Kähler electric flux has an explicit dependence on the induced metric but in a scaling invariant manner. The most obvious objection relates to the sign factor of the dual flux which depends on the orientation of the string world sheet and thus changes sign when the orientation of space-time sheet is changed by changing that of the string world sheet. This is in conflict with the independence of Kähler action on orientation. One can however argue that the orientation makes itself actually physically visible via the weak form of electric-magnetic duality and that the change of the orientation as a symmetry is dynamically broken. This breaking would be analogous to parity breaking at the level of imbedding space.
3. In [?] it is proposed that braids defined by the boundaries of string world sheets could correspond to Legendrian sub-manifolds, whereas partonic 2-surfaces could be the duals of Legendrian manifolds, so that braiding would take place dynamically. The identification of the Kähler action as Kähler magnetic flux associated with string world sheets and possibly also partonic 2-surfaces is consistent with the assumption that the extremal of Kähler action is in question. Indeed, the Legendrian property says that the projection of the Kähler gauge potential on braid strand vanishes and this expresses the extremality of the Kähler magnetic flux.

The assumption that Kähler action is proportional to Kähler magnetic flux seems to be consistent with the minimal surface property. The weak form of electric-magnetic duality gives a constraint on the normal derivatives of imbedding space coordinates at the string world sheet and minimal surface property strengthens these constraints. One could perhaps say that space-time surface chooses its shape in such a manner that the string world sheet has a minimal area.

The open questions are following.

1. Does Kähler action for the preferred extremals reduce to the area of the string world sheet or to Kähler flux, or are the representations equivalent so that the induced Kähler form would effectively define area form? If the Kähler form associated with the induced metric on string world sheet is proportional to the induced Kähler form the Kähler magnetic flux is proportional to the area and Kähler action reduces to genuine area. This condition looks like a natural additional constraint on string world sheets besides minimal surface property.
2. The proportionality of the induced Kähler form and Kähler form of the induced 2-metric implies as such only the extremal property against the symplectic variations so that one cannot have minimal surface property at imbedding space level. Minimality at space-time level is however possible since space-time surface itself can arrange the situation so that general variations deforming the string world sheet along space-time surface reduce to symplectic variations at the level of the imbedding space.
3. Does the situation depend on whether the string world sheet is in Minkowskian or Euclidian space-time region? The problem is that in Euclidian regions the value of Kähler action is positive definite and it is not obvious why the Kähler magnetic flux for Euclidian string world sheets should have a fixed sign. Could weak form of electric-magnetic duality fix the sign?

Irrespective whether the Kähler action is proportional to the total area or the Kähler electric flux over string world sheets, the theory would be exactly solvable at string world sheet level (finite measurement resolution).

#### 9.8.4 What is the interpretation of Yangian duality in TGD framework?

Minimal surfaces in both configuration space and momentum space are used in the above mentioned two articles [?, ?]. The possibility of these two descriptions must reflect the Yangian symmetry unifying the conformal symmetries of Minkowski space and momentum space in twistorial approach.

The minimal surfaces in  $X^4 \subset M^4 \times CP_2$  are natural in TGD framework. Could also the minimal surfaces in momentum space have some interpretation in TGD framework? Or more generally, what could be the interpretation of the dual descriptions provided by twistor diagrams with light-like

edges and dual twistor diagrams with light-like vertices? One can imagine many interpretations but zero energy ontology suggests an especially attractive and natural interpretation of this duality as the exchange of the roles of wormhole throats carrying always on mass shell massless momenta and wormhole contacts carrying in general off-mass shell momenta and massive momenta in incoming lines.

1. For configuration space twistor diagrams vertices correspond to incoming and outgoing light-like momenta. The light-like momenta associated with the wormhole throats of the incoming and outgoing lines of generalized Feynman diagram could correspond to the light-like momenta associated with the vertices of the polygon. The internal lines defined by wormhole contacts carrying virtual off mass shell momenta would naturally correspond to to edges of the twistor diagram.
2. What about dual twistor diagrams in which light-like momenta correspond to lines? Zero energy ontology implies that virtual wormhole throats carry on mass shell massless momenta whereas incoming wormhole contacts in general carry massive particles: this guarantees the absence of IR divergences. Could one identify the momenta of internal wormhole throats as light-like momenta associated with the lines dual twistor diagrams and the incoming net momenta assignable to wormhole contacts as incoming and outgoing momenta.

Also the transition from Minkowskian to Euclidian signature by Wick rotation could have interpretation in TGD framework. Space-time surfaces decompose into Minkowskian and Euclidian regions. The latter ones represent generalized Feynman diagrams. This suggests a generalization of Wick rotation. The string world sheets in Euclidian regions would define the analogs of the minimal surfaces in Euclidian  $AdS_5$  and the string world sheets in Minkowskian regions the analogs of Minkowskian  $AdS_5$ . The magnitudes of the areas would be identical so that they might be seen as analytical continuations of each other in some sense. Note that partonic 2-surfaces would belong to the intersection of Euclidian and Minkowskian space-time regions. This argument tells nothing about possible momentum space analog of  $M^4 \times CP_2$ .



# Mathematics

- [A1] Gaussian Mersenne. <http://primes.utm.edu/glossary/xpage/GaussianMersenne.html>.
- [A2] Z. I. Borevich and I. R. Shafarevich. *Number Theory*. Academic Press, 1966.
- [A3] Eisenhart. *Riemannian Geometry*. Princeton University Press, 1964.
- [A4] C. N. Pope G. W. Gibbons.  $CP_2$  as gravitational instanton. *Comm. Math. Phys.*, 55, 1977.
- [A5] W. Hawking, S. and N. Pope, C. Generalized Spin Structures in Quantum Gravity. *Phys. Lett.*, (1), 1978.
- [A6] S. Helgason. *Differential Geometry and Symmetric Spaces*. Academic Press, New York, 1962.
- [A7] C. Itzykson and J-B. Zuber. *Quantum Field Theory*, volume 549. Mc Graw-Hill, New York, 1980.
- [A8] J. Milnor. *Topology form Differential Point of View*. The University Press of Virginia, Virginia, 1965.
- [A9] D. S. Moak. The q-analogue of the Laguerre polynomials. *J. Math. Anal. Appl.*, 81, 1981.
- [A10] N. Pope, C. Eigenfunctions and  $Spin^c$  Structures on  $CP_2$ , 1980.
- [A11] B. Shipman. The geometry of momentum mappings on generalized flag manifolds, connections with a dynamical system, quantum mechanics and the dance of honeybee. <http://math.cornell.edu/~oliver/Shipman.gif>, 1998.
- [A12] M. Spivak. *Differential Geometry I,II,III,IV*. Publish or Perish, Boston, 1970.
- [A13] J. Hanson T. Eguchi, B. Gilkey. *Phys. Rep.*, 66:1980, 1980.
- [A14] R. Thom. *Commentarii Math. Helvet.*, 28, 1954.
- [A15] Wallace. *Differential Topology*. W. A. Benjamin, New York, 1968.
- [A16] E. C. Zeeman. *Catastrophe Theory*. Addison-Wessley Publishing Company, 1977.



# Theoretical Physics

- [B1] J. Björken and S. Drell. *Relativistic Quantum Fields*. Mc Graw-Hill, New York, 1965.
- [B2] K. Huang. *Quarks, Leptons & Gauge Fields*. World Scientific, 1982.
- [B3] R. Kiehn. Electromagnetic waves in vacuum with torsion and spin. <http://www22.pair.com/csdc/pdf/helical6.pdf>.
- [B4] G. Parisi. *Field Theory, Disorder and Simulations*. World Scientific, 1992.
- [B5] A. Zee. *The Unity of Forces in the Universe*. World Science Press, Singapore, 1982.





# Books related to TGD

- [K1] M. Pitkänen. 1983.
- [K2] M. Pitkänen. Is it Possible to Understand Coupling Constant Evolution at Space-Time Level? In *Towards M-Matrix*. Onlinebook. [http://tgdtheory.com/public\\_html/tgdquant/tgdquant.html#rgflow](http://tgdtheory.com/public_html/tgdquant/tgdquant.html#rgflow), 2006.
- [K3] M. Pitkänen. About Strange Effects Related to Rotating Magnetic Systems . In *TGD and Fringe Physics*. Onlinebook. [http://tgdtheory.com/public\\_html/freenergy/freenergy.html#Faraday](http://tgdtheory.com/public_html/freenergy/freenergy.html#Faraday), 2006.
- [K4] M. Pitkänen. About the New Physics Behind Qualia. In *Quantum Hardware of Living Matter*. Onlinebook. [http://tgdtheory.com/public\\_html/bioware/bioware.html#newphys](http://tgdtheory.com/public_html/bioware/bioware.html#newphys), 2006.
- [K5] M. Pitkänen. An Overview about Quantum TGD: Part I. In *Topological Geometrodynamics: Overview*. Onlinebook. [http://tgdtheory.com/public\\_html/tgdview/tgdview.html#evoII](http://tgdtheory.com/public_html/tgdview/tgdview.html#evoII), 2006.
- [K6] M. Pitkänen. An Overview about the Evolution of Quantum TGD. In *Topological Geometrodynamics: Overview*. Onlinebook. [http://tgdtheory.com/public\\_html/tgdview/tgdview.html#evoI](http://tgdtheory.com/public_html/tgdview/tgdview.html#evoI), 2006.
- [K7] M. Pitkänen. Anomalies Related to the Classical  $Z^0$  Force and Gravitation. In *TGD and Fringe Physics*. Onlinebook. [http://tgdtheory.com/public\\_html/freenergy/freenergy.html#Zanom](http://tgdtheory.com/public_html/freenergy/freenergy.html#Zanom), 2006.
- [K8] M. Pitkänen. Appendix A: Quantum Groups and Related Structures. In *Towards M-Matrix*. Onlinebook. [http://tgdtheory.com/public\\_html/tgdquant/tgdquant.html#bialgebra](http://tgdtheory.com/public_html/tgdquant/tgdquant.html#bialgebra), 2006.
- [K9] M. Pitkänen. Basic Extremals of Kähler Action. In *Physics in Many-Sheeted Space-Time*. Onlinebook. [http://tgdtheory.com/public\\_html/tgdclass/tgdclass.html#class](http://tgdtheory.com/public_html/tgdclass/tgdclass.html#class), 2006.
- [K10] M. Pitkänen. *Bio-Systems as Conscious Holograms*. Onlinebook. [http://tgdtheory.com/public\\_html/hologram/hologram.html](http://tgdtheory.com/public_html/hologram/hologram.html), 2006.
- [K11] M. Pitkänen. Bio-Systems as Conscious Holograms. In *Bio-Systems as Conscious Holograms*. Onlinebook. [http://tgdtheory.com/public\\_html/hologram/hologram.html#hologram](http://tgdtheory.com/public_html/hologram/hologram.html#hologram), 2006.
- [K12] M. Pitkänen. *Bio-Systems as Self-Organizing Quantum Systems*. Onlinebook. [http://tgdtheory.com/public\\_html/bioselforg/bioselforg.html](http://tgdtheory.com/public_html/bioselforg/bioselforg.html), 2006.
- [K13] M. Pitkänen. Bio-Systems as Super-Conductors: part I. In *Quantum Hardware of Living Matter*. Onlinebook. [http://tgdtheory.com/public\\_html/bioware/bioware.html#superc1](http://tgdtheory.com/public_html/bioware/bioware.html#superc1), 2006.
- [K14] M. Pitkänen. Bio-Systems as Super-Conductors: part II. In *Quantum Hardware of Living Matter*. Onlinebook. [http://tgdtheory.com/public\\_html/bioware/bioware.html#superc2](http://tgdtheory.com/public_html/bioware/bioware.html#superc2), 2006.
- [K15] M. Pitkänen. Configuration Space Spinor Structure. In *Quantum Physics as Infinite-Dimensional Geometry*. Onlinebook. [http://tgdtheory.com/public\\_html/tgdgeom/tgdgeom.html#cspin](http://tgdtheory.com/public_html/tgdgeom/tgdgeom.html#cspin), 2006.

- [K16] M. Pitkänen. Construction of elementary particle vacuum functionals. In *p-Adic Length Scale Hypothesis and Dark Matter Hierarchy*. Onlinebook. [http://tgdtheory.com/public\\_html/paddark/paddark.html#elvafu](http://tgdtheory.com/public_html/paddark/paddark.html#elvafu), 2006.
- [K17] M. Pitkänen. Construction of Quantum Theory: M-matrix. In *Towards M-Matrix*. Onlinebook. [http://tgdtheory.com/public\\_html/tgdquant/tgdquant.html#towards](http://tgdtheory.com/public_html/tgdquant/tgdquant.html#towards), 2006.
- [K18] M. Pitkänen. Cosmic Strings. In *Physics in Many-Sheeted Space-Time*. Onlinebook. [http://tgdtheory.com/public\\_html/tgdclass/tgdclass.html#cstrings](http://tgdtheory.com/public_html/tgdclass/tgdclass.html#cstrings), 2006.
- [K19] M. Pitkänen. Crop Circles and Life at Parallel Space-Time Sheets. In *Magnetospheric Consciousness*. Onlinebook. [http://tgdtheory.com/public\\_html/magnconsc/magnconsc.html#crop1](http://tgdtheory.com/public_html/magnconsc/magnconsc.html#crop1), 2006.
- [K20] M. Pitkänen. Crop Circles and Life at Parallel Space-Time Sheets. In *Magnetospheric Consciousness*. Onlinebook. [http://tgdtheory.com/public\\_html/magnconsc/magnconsc.html#crop2](http://tgdtheory.com/public_html/magnconsc/magnconsc.html#crop2), 2006.
- [K21] M. Pitkänen. Dark Forces and Living Matter. In *p-Adic Length Scale Hypothesis and Dark Matter Hierarchy*. Onlinebook. [http://tgdtheory.com/public\\_html/paddark/paddark.html#darkforces](http://tgdtheory.com/public_html/paddark/paddark.html#darkforces), 2006.
- [K22] M. Pitkänen. Dark Matter Hierarchy and Hierarchy of EEGs. In *TGD and EEG*. Onlinebook. [http://tgdtheory.com/public\\_html/tgdeeg/tgdeeg.html#eegdark](http://tgdtheory.com/public_html/tgdeeg/tgdeeg.html#eegdark), 2006.
- [K23] M. Pitkänen. Dark Nuclear Physics and Condensed Matter. In *p-Adic Length Scale Hypothesis and Dark Matter Hierarchy*. Onlinebook. [http://tgdtheory.com/public\\_html/paddark/paddark.html#exonuclear](http://tgdtheory.com/public_html/paddark/paddark.html#exonuclear), 2006.
- [K24] M. Pitkänen. DNA as Topological Quantum Computer. In *Genes and Memes*. Onlinebook. [http://tgdtheory.com/public\\_html/genememe/genememe.html#dnatqc](http://tgdtheory.com/public_html/genememe/genememe.html#dnatqc), 2006.
- [K25] M. Pitkänen. Does TGD Predict the Spectrum of Planck Constants? In *Towards M-Matrix*. Onlinebook. [http://tgdtheory.com/public\\_html/tgdquant/tgdquant.html#Planck](http://tgdtheory.com/public_html/tgdquant/tgdquant.html#Planck), 2006.
- [K26] M. Pitkänen. Evolution in Many-Sheeted Space-Time. In *Genes and Memes*. Onlinebook. [http://tgdtheory.com/public\\_html/genememe/genememe.html#prebio](http://tgdtheory.com/public_html/genememe/genememe.html#prebio), 2006.
- [K27] M. Pitkänen. General Ideas about Many-Sheeted Space-Time: Part I. In *Physics in Many-Sheeted Space-Time*. Onlinebook. [http://tgdtheory.com/public\\_html/tgdclass/tgdclass.html#topcond](http://tgdtheory.com/public_html/tgdclass/tgdclass.html#topcond), 2006.
- [K28] M. Pitkänen. General Theory of Qualia. In *Bio-Systems as Conscious Holograms*. Onlinebook. [http://tgdtheory.com/public\\_html/hologram/hologram.html#qualia](http://tgdtheory.com/public_html/hologram/hologram.html#qualia), 2006.
- [K29] M. Pitkänen. *Genes and Memes*. Onlinebook. [http://tgdtheory.com/public\\_html/genememe/genememe.html](http://tgdtheory.com/public_html/genememe/genememe.html), 2006.
- [K30] M. Pitkänen. Genes and Memes. In *Genes and Memes*. Onlinebook. [http://tgdtheory.com/public\\_html/genememe/genememe.html#genememec](http://tgdtheory.com/public_html/genememe/genememe.html#genememec), 2006.
- [K31] M. Pitkänen. Homeopathy in Many-Sheeted Space-Time. In *Bio-Systems as Conscious Holograms*. Onlinebook. [http://tgdtheory.com/public\\_html/hologram/hologram.html#homeoc](http://tgdtheory.com/public_html/hologram/hologram.html#homeoc), 2006.
- [K32] M. Pitkänen. Macro-Temporal Quantum Coherence and Spin Glass Degeneracy. In *Bio-Systems as Conscious Holograms*. Onlinebook. [http://tgdtheory.com/public\\_html/hologram/hologram.html#macro](http://tgdtheory.com/public_html/hologram/hologram.html#macro), 2006.
- [K33] M. Pitkänen. Macroscopic Quantum Coherence and Quantum Metabolism as Different Sides of the Same Coin. In *Bio-Systems as Conscious Holograms*. Onlinebook. [http://tgdtheory.com/public\\_html/hologram/hologram.html#metab](http://tgdtheory.com/public_html/hologram/hologram.html#metab), 2006.

- [K34] M. Pitkänen. Macroscopic Quantum Phenomena and  $CP_2$  Geometry. In *Physics in Many-Sheeted Space-Time*. Onlinebook. [http://tgdtheory.com/public\\_html/tgdclass/tgdclass.html#super](http://tgdtheory.com/public_html/tgdclass/tgdclass.html#super), 2006.
- [K35] M. Pitkänen. Magnetic Sensory Canvas Hypothesis. In *TGD and EEG*. Onlinebook. [http://tgdtheory.com/public\\_html//tgdeeg/tgdeeg/tgdeeg.html#mec](http://tgdtheory.com/public_html//tgdeeg/tgdeeg/tgdeeg.html#mec), 2006.
- [K36] M. Pitkänen. *Magnetospheric Consciousness*. Onlinebook. [http://tgdtheory.com/public\\_html/magnconsc/magnconsc.html](http://tgdtheory.com/public_html/magnconsc/magnconsc.html), 2006.
- [K37] M. Pitkänen. Magnetospheric Sensory Representations. In *Magnetospheric Consciousness*. Onlinebook. [http://tgdtheory.com/public\\_html/magnconsc/magnconsc.html#srepress](http://tgdtheory.com/public_html/magnconsc/magnconsc.html#srepress), 2006.
- [K38] M. Pitkänen. Many-Sheeted DNA. In *Genes and Memes*. Onlinebook. [http://tgdtheory.com/public\\_html/genememe/genememe.html#genecodec](http://tgdtheory.com/public_html/genememe/genememe.html#genecodec), 2006.
- [K39] M. Pitkänen. Massless states and particle massivation. In *p-Adic Length Scale Hypothesis and Dark Matter Hierarchy*. Onlinebook. [http://tgdtheory.com/public\\_html/paddark/paddark.html#mless](http://tgdtheory.com/public_html/paddark/paddark.html#mless), 2006.
- [K40] M. Pitkänen. *Mathematical Aspects of Consciousness Theory*. Onlinebook. [http://tgdtheory.com/public\\_html/mathconsc/mathconsc.html](http://tgdtheory.com/public_html/mathconsc/mathconsc.html), 2006.
- [K41] M. Pitkänen. Matter, Mind, Quantum. In *TGD Inspired Theory of Consciousness*. Onlinebook. [http://tgdtheory.com/public\\_html/tgdconsc/tgdconsc.html#conscic](http://tgdtheory.com/public_html/tgdconsc/tgdconsc.html#conscic), 2006.
- [K42] M. Pitkänen. Negentropy Maximization Principle. In *TGD Inspired Theory of Consciousness*. Onlinebook. [http://tgdtheory.com/public\\_html/tgdconsc/tgdconsc.html#nmpc](http://tgdtheory.com/public_html/tgdconsc/tgdconsc.html#nmpc), 2006.
- [K43] M. Pitkänen. New Particle Physics Predicted by TGD: Part I. In *p-Adic Length Scale Hypothesis and Dark Matter Hierarchy*. Onlinebook. [http://tgdtheory.com/public\\_html/paddark/paddark.html#mass4](http://tgdtheory.com/public_html/paddark/paddark.html#mass4), 2006.
- [K44] M. Pitkänen. Nuclear String Hypothesis. In *p-Adic Length Scale Hypothesis and Dark Matter Hierarchy*. Onlinebook. [http://tgdtheory.com/public\\_html/paddark/paddark.html#nuclstring](http://tgdtheory.com/public_html/paddark/paddark.html#nuclstring), 2006.
- [K45] M. Pitkänen. *p-Adic length Scale Hypothesis and Dark Matter Hierarchy*. Onlinebook. [http://tgdtheory.com/public\\_html/paddark/paddark.html](http://tgdtheory.com/public_html/paddark/paddark.html), 2006.
- [K46] M. Pitkänen. p-Adic Particle Massivation: Hadron Masses. In *p-Adic Length Scale Hypothesis and Dark Matter Hierarchy*. Onlinebook. [http://tgdtheory.com/public\\_html/paddark/paddark.html#mass3](http://tgdtheory.com/public_html/paddark/paddark.html#mass3), 2006.
- [K47] M. Pitkänen. p-Adic Physics as Physics of Cognition and Intention. In *TGD Inspired Theory of Consciousness*. Onlinebook. [http://tgdtheory.com/public\\_html/tgdconsc/tgdconsc.html#cognic](http://tgdtheory.com/public_html/tgdconsc/tgdconsc.html#cognic), 2006.
- [K48] M. Pitkänen. *Physics in Many-Sheeted Space-Time*. Onlinebook. [http://tgdtheory.com/public\\_html/tgdclass/tgdclass.html](http://tgdtheory.com/public_html/tgdclass/tgdclass.html), 2006.
- [K49] M. Pitkänen. Quantum Antenna Hypothesis. In *Quantum Hardware of Living Matter*. Onlinebook. [http://tgdtheory.com/public\\_html/bioware/bioware.html#tubuc](http://tgdtheory.com/public_html/bioware/bioware.html#tubuc), 2006.
- [K50] M. Pitkänen. Quantum Astrophysics. In *Physics in Many-Sheeted Space-Time*. Onlinebook. [http://tgdtheory.com/public\\_html/tgdclass/tgdclass.html#qastro](http://tgdtheory.com/public_html/tgdclass/tgdclass.html#qastro), 2006.
- [K51] M. Pitkänen. Quantum Control and Coordination in Bio-systems: Part I. In *Bio-Systems as Self-Organizing Quantum Systems*. Onlinebook. [http://tgdtheory.com/public\\_html/bioselforg/bioselforg.html#qcococI](http://tgdtheory.com/public_html/bioselforg/bioselforg.html#qcococI), 2006.
- [K52] M. Pitkänen. Quantum Control and Coordination in Bio-Systems: Part II. In *Bio-Systems as Self-Organizing Quantum Systems*. Onlinebook. [http://tgdtheory.com/public\\_html/bioselforg/bioselforg.html#qcococII](http://tgdtheory.com/public_html/bioselforg/bioselforg.html#qcococII), 2006.

- [K53] M. Pitkänen. *Quantum Hardware of Living Matter*. Onlinebook. [http://tgdtheory.com/public\\_html/bioware/bioware.html](http://tgdtheory.com/public_html/bioware/bioware.html), 2006.
- [K54] M. Pitkänen. Quantum Model for Hearing. In *TGD and EEG*. Onlinebook. [http://tgdtheory.com/public\\_html//tgdeeg/tgdeeg/tgdeeg.html#hearing](http://tgdtheory.com/public_html//tgdeeg/tgdeeg/tgdeeg.html#hearing), 2006.
- [K55] M. Pitkänen. Quantum Model for Nerve Pulse. In *TGD and EEG*. Onlinebook. [http://tgdtheory.com/public\\_html//tgdeeg/tgdeeg/tgdeeg.html#pulse](http://tgdtheory.com/public_html//tgdeeg/tgdeeg/tgdeeg.html#pulse), 2006.
- [K56] M. Pitkänen. Quantum Model for Paranormal Phenomena. In *TGD Inspired Theory of Consciousness*. Onlinebook. [http://tgdtheory.com/public\\_html/tgdconsc/tgdconsc.html#parac](http://tgdtheory.com/public_html/tgdconsc/tgdconsc.html#parac), 2006.
- [K57] M. Pitkänen. Quantum Model for Sensory Representations. In *TGD Inspired Theory of Consciousness*. Onlinebook. [http://tgdtheory.com/public\\_html/tgdconsc/tgdconsc.html#expc](http://tgdtheory.com/public_html/tgdconsc/tgdconsc.html#expc), 2006.
- [K58] M. Pitkänen. Quantum Model of EEG. In *TGD and EEG*. Onlinebook. [http://tgdtheory.com/public\\_html/tgdeeg/tgdeeg.html#eegII](http://tgdtheory.com/public_html/tgdeeg/tgdeeg.html#eegII), 2006.
- [K59] M. Pitkänen. Quantum Model of Memory. In *TGD Inspired Theory of Consciousness*. Onlinebook. [http://tgdtheory.com/public\\_html/tgdconsc/tgdconsc.html#memoryc](http://tgdtheory.com/public_html/tgdconsc/tgdconsc.html#memoryc), 2006.
- [K60] M. Pitkänen. *Quantum Physics as Infinite-Dimensional Geometry*. Onlinebook. [http://tgdtheory.com/public\\_html/tgdgeom/tgdgeom.html](http://tgdtheory.com/public_html/tgdgeom/tgdgeom.html), 2006.
- [K61] M. Pitkänen. *Quantum TGD*. Onlinebook. [http://tgdtheory.com/public\\_html/tgdquant/tgdquant.html](http://tgdtheory.com/public_html/tgdquant/tgdquant.html), 2006.
- [K62] M. Pitkänen. Quantum Theory of Self-Organization. In *Bio-Systems as Self-Organizing Quantum Systems*. Onlinebook. [http://tgdtheory.com/public\\_html/bioselforg/bioselforg.html#selforgac](http://tgdtheory.com/public_html/bioselforg/bioselforg.html#selforgac), 2006.
- [K63] M. Pitkänen. Semi-trance, Mental Illness, and Altered States of Consciousness. In *Magnetospheric Consciousness*. Onlinebook. [http://tgdtheory.com/public\\_html/magnconsc/magnconsc.html#semitrancec](http://tgdtheory.com/public_html/magnconsc/magnconsc.html#semitrancec), 2006.
- [K64] M. Pitkänen. Semitrance, Language, and Development of Civilization. In *Magnetospheric Consciousness*. Onlinebook. [http://tgdtheory.com/public\\_html/magnconsc/magnconsc.html#langsoc](http://tgdtheory.com/public_html/magnconsc/magnconsc.html#langsoc), 2006.
- [K65] M. Pitkänen. TGD and Astrophysics. In *Physics in Many-Sheeted Space-Time*. Onlinebook. [http://tgdtheory.com/public\\_html/tgdclass/tgdclass.html#astro](http://tgdtheory.com/public_html/tgdclass/tgdclass.html#astro), 2006.
- [K66] M. Pitkänen. TGD and Cosmology. In *Physics in Many-Sheeted Space-Time*. Onlinebook. [http://tgdtheory.com/public\\_html/tgdclass/tgdclass.html#cosmo](http://tgdtheory.com/public_html/tgdclass/tgdclass.html#cosmo), 2006.
- [K67] M. Pitkänen. *TGD and EEG*. Onlinebook. [http://tgdtheory.com/public\\_html/tgdeeg/tgdeeg.html](http://tgdtheory.com/public_html/tgdeeg/tgdeeg.html), 2006.
- [K68] M. Pitkänen. *TGD and Fringe Physics*. Onlinebook. [http://tgdtheory.com/public\\_html/freenergy/freenergy.html](http://tgdtheory.com/public_html/freenergy/freenergy.html), 2006.
- [K69] M. Pitkänen. TGD and Nuclear Physics. In *p-Adic Length Scale Hypothesis and Dark Matter Hierarchy*. Onlinebook. [http://tgdtheory.com/public\\_html/paddark/paddark.html#padnucl](http://tgdtheory.com/public_html/paddark/paddark.html#padnucl), 2006.
- [K70] M. Pitkänen. *TGD as a Generalized Number Theory*. Onlinebook. [http://tgdtheory.com/public\\_html/tgdnumber/tgdnumber.html](http://tgdtheory.com/public_html/tgdnumber/tgdnumber.html), 2006.
- [K71] M. Pitkänen. TGD as a Generalized Number Theory: p-Adicization Program. In *TGD as a Generalized Number Theory*. Onlinebook. [http://tgdtheory.com/public\\_html/tgdnumber/tgdnumber.html#visiona](http://tgdtheory.com/public_html/tgdnumber/tgdnumber.html#visiona), 2006.

- [K72] M. Pitkänen. TGD as a Generalized Number Theory: Quaternions, Octonions, and their Hyper Counterparts. In *TGD as a Generalized Number Theory*. Onlinebook. [http://tgdtheory.com/public\\_html/tgdnumber/tgdnumber.html#visionb](http://tgdtheory.com/public_html/tgdnumber/tgdnumber.html#visionb), 2006.
- [K73] M. Pitkänen. TGD Based Model for OBEs. In *TGD Inspired Theory of Consciousness*. Onlinebook. [http://tgdtheory.com/public\\_html/tgdconsc/tgdconsc.html#OBE](http://tgdtheory.com/public_html/tgdconsc/tgdconsc.html#OBE), 2006.
- [K74] M. Pitkänen. *TGD Inspired Theory of Consciousness*. Onlinebook. [http://tgdtheory.com/public\\_html/tgdconsc/tgdconsc.html](http://tgdtheory.com/public_html/tgdconsc/tgdconsc.html), 2006.
- [K75] M. Pitkänen. TGD Inspired Theory of Consciousness. In *Topological Geometrodynamics: Overview*. Onlinebook. [http://tgdtheory.com/public\\_html/tgdview/tgdview.html#tgdconsc2010](http://tgdtheory.com/public_html/tgdview/tgdview.html#tgdconsc2010), 2006.
- [K76] M. Pitkänen. The Notion of Free Energy and Many-Sheeted Space-Time Concept. In *TGD and Fringe Physics*. Onlinebook. [http://tgdtheory.com/public\\_html/freenergy/freenergy.html#freenergy](http://tgdtheory.com/public_html/freenergy/freenergy.html#freenergy), 2006.
- [K77] M. Pitkänen. The Relationship Between TGD and GRT. In *Physics in Many-Sheeted Space-Time*. Onlinebook. [http://tgdtheory.com/public\\_html/tgdclass/tgdclass.html#tgdgrt](http://tgdtheory.com/public_html/tgdclass/tgdclass.html#tgdgrt), 2006.
- [K78] M. Pitkänen. Three new physics realizations of the genetic code and the role of dark matter in bio-systems. In *Genes and Memes*. Onlinebook. [http://tgdtheory.com/public\\_html/genememe/genememe.html#dnatqccodes](http://tgdtheory.com/public_html/genememe/genememe.html#dnatqccodes), 2006.
- [K79] M. Pitkänen. Time, Spacetime and Consciousness. In *Bio-Systems as Conscious Holograms*. Onlinebook. [http://tgdtheory.com/public\\_html/hologram/hologram.html#time](http://tgdtheory.com/public_html/hologram/hologram.html#time), 2006.
- [K80] M. Pitkänen. *Topological Geometrodynamics: an Overview*. Onlinebook. [http://tgdtheory.com/public\\_html/tgdview/tgdview.html](http://tgdtheory.com/public_html/tgdview/tgdview.html), 2006.
- [K81] M. Pitkänen. Topological Quantum Computation in TGD Universe. In *Genes and Memes*. Onlinebook. [http://tgdtheory.com/public\\_html/genememe/genememe.html#tqc](http://tgdtheory.com/public_html/genememe/genememe.html#tqc), 2006.
- [K82] M. Pitkänen. Was von Neumann Right After All. In *Towards M-Matrix*. Onlinebook. [http://tgdtheory.com/public\\_html/tgdquant/tgdquant.html#vNeumann](http://tgdtheory.com/public_html/tgdquant/tgdquant.html#vNeumann), 2006.
- [K83] M. Pitkänen. Wormhole Magnetic Fields. In *Quantum Hardware of Living Matter*. Onlinebook. [http://tgdtheory.com/public\\_html/bioware/bioware.html#wormc](http://tgdtheory.com/public_html/bioware/bioware.html#wormc), 2006.



## Chapter 10

# Quantum Field Theory Limit of TGD from Bosonic Emergence

### 10.1 Introduction

In TGD framework S-matrix must be constructed without the help of path integral. In TGD only fermions appear as fundamental particles. This suggests a bootstrap program in which one starts from very simple basic structures and generates the remaining n-point functions as radiative corrections. The success of twistorial unitary cut method in massless gauge theories suggests that its basic results such as recursive generation of tree diagrams might be given a status of axioms. The idea that loop momenta are light-like cannot be however be taken too seriously. Or so I thought! After an enthusiastic period with this idea I was forced to give it up only to rediscover it in a modified form inspired by the zero energy ontology and twistor approach. The idea is that both external and virtual particles are composites of massless states assignable to wormhole throats. External particles are bound states of massless states assignable to wormhole throats. For virtual particles one gives up the bound state constraint and one allows also positive and negative energy wormhole throats to obtain space-like net momenta for for wormhole throats. This framework gives extremely strong constraints on virtual momenta and implies cancellation of UV and also IR divergences. This approach is described in the [?]

This chapter represents a humble intermediate step in the evolution of ideas. The approach is inspired by bosonic emergence which is a basic prediction of TGD and led to the approach to generalized Feynman diagrams based on Yangian symmetry [?]. Bosonic emergence suggests that one could construct the QFT limit of TGD in terms of Dirac action coupled YM gauge potentials with bosonic propagators generated radiatively. Finiteness requires that fermionic loop integrations are not free but restricted by some reasonable conditions guaranteeing finiteness and one simply tries to guess these conditions using p-adic length scale hypothesis. The so called region momenta appearing in twistor Grassmannian approach [?] have in TGD framework direct analogs as pseudo-momenta identified as generalized eigenvalues of Chern-Simons Dirac operator assigned to the wormhole throats. Pseudo-momenta are analogous to off mass shell momenta for a massless particle and for external particles they coincide with real light-like momenta. These momenta are indeed analogous to off mass shell loop momenta but not directly identifiable as net four-momenta for wormhole contacts. Number theoretic constraints suggests that pseudo-momenta are quantized and have a limited value range. Therefore the primitive QFT model of this chapter assuming that virtual momenta are restricted to a finite range in the momentum space can be said to be as a predecessor of the formulation discussed in [?]. This is the reason for why I have decided to keep it.

#### 10.1.1 The dream

Let us summarize the first variant of the dream about bootstrap approach.

1. In [K15, ?] I have discussed how the "almost stringy" fermion propagator arises as one adds to the modified Dirac action a term coupling the charges in a Cartan algebra of the isometry group of  $H = M^4 \times CP_2$  to conserved fermionic currents (there are several of them). Also more

general observables allow this kind of coupling and the interpretation in terms of measurement interaction. This term also realizes quantum classical correspondence by feeding information about quantum numbers of partons to the geometry of space-time sheet so that quantum numbers entangle with the geometry of space-time sheet as holography requires. This measurement interaction was the last piece in the puzzle "What are the basic equations of quantum TGD" and unified several visions about the physics predicted by quantum TGD. "Almost stringy" means that the on mass shell fermions obey stringy mass formulas dictated by super-conformal symmetry but that propagator itself -although it depends on four-momentum- is not the inverse of super-Virasoro generator  $G_0$  as it would be in string models.

2. The identification of bosons as wormhole contacts means that bosonic propagation reduces to a propagation of fermion and antifermion at opposite throats of the wormhole throat. In this framework bosonic n-vertex would correspond to the decay of bosons to fermion-antifermion pairs in the loop. Purely bosonic gauge boson couplings would be generated radiatively from triangle and box diagrams involving only fermion-boson couplings. In particular, bosonic propagator would be generated as a self-energy loop: bosons would propagate by decaying to fermion-antifermion pair and then fusing back to the boson. TGD counterpart for gauge theory dynamics would be emergent and bosonic couplings would have form factors with IR and UV behaviors allowing finiteness of the loops constructed from them since the constraint that virtual fermion pair corresponds to wormhole contact poses strong constraint on virtual momenta of fermion and antifermion.

This picture translates to a dream about QFT limit of TGD where n-boson vertices reduce to fermionic loops defined in standard manner. Unfortunately, this dream about emergence is killed by the general arguments discussed in the chapter about twistors and TGD [?] demonstrating that one encounters UV divergences already in the construction of gauge boson propagator for both free and light-like loop momenta (suggested by twistorial ideas). The physical reason for the emergence of these divergences and also their cure at the level of principle is well-understood in TGD Universe.

1. The description in terms of number theoretic braids based on the notion of finite measurement resolution should resolve these divergences at the expense of locality. The physical picture would be provided by the identification of virtual fermion-antifermion pair as wormhole contact.
2. Zero energy ontology brings into the picture also the natural breaking of translational and Lorentz symmetries caused by the selection of the causal diamond ( $CD$ ). This breaking is compensated at the level of configuration space since all Poincare transforms of  $CD$ s are allowed in the construction of the configuration space geometry.
3. If this approach is accepted then for given  $CD$  there are natural IR and UV cutoffs for 3-momentum (perhaps more naturally for these than for mass squared). IR cutoff is quantified by the temporal distance between the tips of  $CD$  and UV cutoff by similar temporal distance of smallest  $CD$  allowed by length scale resolution. If the hypothesis that the temporal distances come as octaves of fundamental time scale given by  $CP_2$  time scale  $T_0$  and implying p-adic length scale hypothesis, the situation is fixed. A weaker condition is that the distances come as prime multiples  $pT_0$  of  $T_0$ .
4. QFT type idealization would make sense in finite measurement resolution and the loop integrals would be both IR and UV finite.

### 10.1.2 Improved dream

The arguments above lead to a modified form of the dream.

1. Only fermionic propagators are allowed and bosonic propagators emerge. Only boson-fermion coupling characterizing the decay of a wormhole contact to two  $CP_2$  type almost vacuum extremals with single wormhole throat carrying fermion and anti-fermion number would be feeded to the theory as something given and everything else would result as radiative corrections. Boson-fermion coupling would be proportional to Kähler coupling strength fixed by quantum criticality and very near or equal to fine structure constant at electron's p-adic length scale for the standard value of Planck constant. If not anything else, this approach would be predictive.



2. This approach could be tried to both free and light-like loop momenta. For free loop momenta the cutoff would be naturally associated with the mass squared of the virtual particle rather than the energy of a massless particle. Despite its Lorentz invariance one could criticize this kind of UV cutoff because it allows arbitrarily small wavelengths not in accordance with the vision about finite measurement resolution. This suggests that these cutoffs must be combined for a given p-adic length scale  $L_p$  to give  $k^\mu k_\mu \equiv M^2 \leq p$  and  $|k_0| \leq p$  using  $M_{CP_2}$  as a unit. Hence only the region defined by the intersection of the four-cube  $k_\mu \leq p$  and  $M^2 \leq p$  contributes to the phase space for cutoff defined by p-adic mass scale  $M_p$ . Its volume behaves like  $p^{3+1/2}$  rather than  $p^4$ . For space-like momenta similar situation prevails. In hyperbolic coordinates ( $k_0 = M \cosh(\eta)$ ,  $|k| = M \sinh(\eta)$ ) for time-like momenta the cutoffs correspond to ( $M \leq \sqrt{p}$ ,  $\cosh(\eta) \leq \sqrt{p}$ ). In hyperbolic coordinates for space-like momenta ( $p_0 = M \sinh(\eta)$ ,  $|p| = M \cosh(\eta)$ ) the cutoffs correspond ( $M \leq \sqrt{p}$ ,  $|\sinh(\eta)| \leq \sqrt{p}$ ).

The following considerations led to the conclusion that bosonic propagators could emerge from fermionic ones in the quantum field theory type description and that this description is also favored by the basic structure of quantum TGD. An essential element of the approach is a physical formulation for UV cutoff. A cutoff in both mass squared and hyperbolic angle is necessary since Wick rotation does not make sense in TGD framework. This approach predicts all gauge couplings and assuming a geometrically very natural hyperbolic UV cutoff motivated by zero energy ontology one can understand the evolution of standard model gauge couplings and reproduce correctly the values of fine structure constant at electron and intermediate boson length scales. Also asymptotic freedom follows as a basic prediction. The UV cutoff for the hyperbolic angle as a function of p-adic length scale is the ad hoc element of the model in its recent form, and a quantitative model for how this function could be fixed by quantum criticality is formulated and studied.

These considerations and numerical calculations lead to a general vision about how real and p-adic variants of TGD relate to each other and how p-adic fractalization takes place.

1. Only fermionic loops would be fundamental and define bosonic propagators and vertices. In twistor approach generalized Cutkosky rules allow the unitarization of the tree amplitudes in terms of  $TT^\dagger$  contribution involving only light-like momenta. Also in TGD this seems to be the only working option for the bosonic loops at massless limit and requires that  $TT^\dagger$  makes sense p-adically. The treatment of the massive case suggests the generalization of twistors to 8-D context [?].
2. The vanishing of the fermionic loops defining bosonic vertices for the incoming massless momenta emerges as a consistency condition suggested also by quantum criticality and by the fact that only BFF vertex is fundamental vertex if bosonic emergence is accepted. The vanishing of on mass shell N-vertices gives an infinite number of conditions on the hyperbolic cutoff as function of the integer  $k$  labeling p-adic length scale at the limit when bosons are massless and IR cutoff for the loop mass scale is taken to zero. These condition generalize also to the massive case and even to quantum TGD proper a first principle definition of the fermionic loops allowing in turn to define bosonic loops as discontinuity of  $TT^\dagger$  obtained by putting on particles on mass shell. It is not yet clear whether dynamical symmetries, in particular super-conformal symmetries, are involved with the realization of the vanishing conditions or whether hyperbolic cutoff is all that is needed.

This picture emerged through calculations which evolved from the first trials through the discovery of an impressive number of numerical errors related to signs factors, numerical factors, and exponents but there are reasons to believe that big blunders have been eliminated now so that one can trust the results of calculations and conclusions following from them. Calculations are also far from complete. For instance, propagator has not been calculated for space-like momenta and it is not clear whether one can trust on the naive analytical continuation. Formal rigor of course does not yet guarantee that the physical picture is correct.

### 10.1.3 SUSY improved dream

The basic criticism against the first version of the improved dream is the need to introduce explicit cutoffs in hyperbolic angle and mass squared for the fermions appearing in fermion loops. These

cutoffs should emerge from dynamics alone. The realization of super-symmetry at space-time level in TGD sense [?] requires bosonic emergence as internal consistency condition, avoids these explicit cutoffs, and leads to an UV finite theory by standard arguments about cancelation of fermion and sfermion loops in SUSYs. This realizes a 31 year old dream to a surprisingly high degree. Everything would emerge radiatively from the modified Dirac operator and boson-fermion vertices (and their super counterparts) dictated by the charge matrix of the boson coding boson as a fermion-antifermion bilinear.

The super-symmetry in question corresponds to a new variant of standard SUSY having  $\mathcal{N} = \infty$ . It is natural to ask whether a natural cutoff in the value of  $\mathcal{N}$  could emerge from the theory. The notion of braid realizing at space-time level the notion of finite measurement resolution would certainly imply this kind of cutoff since the number of fermionic oscillator operators would be finite. The so called weak form of electric-magnetic duality [?] led to a dramatic integration of various ideas related to the quantum TGD. The earlier general solution ansatz for the preferred extremals was understood in much more detailed manner and dual interpretations of solution ansatz in terms of non-linear Maxwell's electrodynamics and hydrodynamics were found [K9]. It was realized that this ansatz implies automatically the reduction of TGD to almost topological QFT in the sense that Kähler function of WCW reduces to Chern-Simons term. Also Kähler Dirac equation and Chern-Simons Dirac equation were understood. In particular, the study of generalized eigen modes of Chern-Simons Dirac equation demonstrated that braids and their number theoretic variants emerge from the basic quantum TGD. Therefore the cutoff in  $\mathcal{N}$  is coded to the dynamics.

#### 10.1.4 ZEO improved dream

A new twist in the dream about finite S-matrix emerged with the realization that in zero energy ontology (ZEO) virtual particles could correspond to wormhole contacts carrying non-parallel mass shell momenta which can also correspond to opposite energies [?, ?]. It is indeed possible to have both space-like and time-like net momenta for the wormhole contact in this manner so that one would end up with a variant of the original idea about the replacement of virtual particles with on mass shell massless particles, which as such was a failure. It is strange how even the silliest looking idea seems to be an attempt of some bigger mind to communicate to the stupid theoretician something important.

On mass shell property does not lead to a disaster since the propagator is not ordinary Dirac propagator (which would of course diverge) but is defined by the Chern-Simons Dirac operator- essentially Dirac propagator for a 2-D pseudo-momentum having discrete set of allowed values. There are good arguments that the allowed pseudo-momenta correspond to hyper-complex primes and possibly a finite number of their powers so that they do not induce divergences. Also a connection with the notion of infinite prime and corresponding arithmetic quantum field theory emerges [?].

The progress was stimulated by the simple observation that on mass shell property puts enormously strong kinematic restrictions on the loop integrations. With mild restrictions on the number of parallel fermion lines appearing in vertices (there can be several since fermionic oscillator operator algebra defining SUSY algebra generates the parton states)- all loops are manifestly finite and if particles has always mass -say small p-adic thermal mass also in case of massless particles and due to IR cutoff due to the presence largest CD- the number of diagrams is finite. Unitarity reduces to Cutkosky rules [?] automatically satisfied as in the case of ordinary Feynman diagrams. The last section of the chapter is devoted to a brief summary of this approach which should have a counterpart also in the description of QFT limit of TGD. Also SUSY is consistent with the reduction of off mass shell states to pairs of on mass shell states and guarantees finiteness of the very few loop summations that remain when kinematic conditions are applied (self energy loops remain and should vanish by SUSY).

#### 10.1.5 What can one conclude?

What one can abstract from these dreams might be the following vision.

1. Bosonic emergence and its generalization implying that fermionic propagator is the basic object. Even in standard gauge theory framework this means enormous simplification if one can define UV cutoffs.
2. Generalization of SUSY and the emergence of the notion of braids implying a reduction to SUSY algebra with a finite value of  $\mathcal{N}$ . SUSY gives excellent hopes about the finiteness of the QFT

limit even when UV cutoff is not assumed.

3. The reduction of off mass shell states to pairs of on mass shell states in ZEO modifying dramatically the physical interpretation of Feynman diagrammatics and implying a manifest finiteness and unitarity of the theory. The reduction to almost topological QFT implies that fermionic propagators are for 2-D discrete pseudo-momentum rather than for real off mass shell momentum. This description as such is certainly not directly related to QFT description.

The reader should be warned that this dreaming or might it be called dream walking represents only a story about evolution of ideas and my motivation for keeping all this material is just for the fact that I feel important to be honest and confess all the side tracks that I have made. As already mentioned in the beginning, this chapter can be seen as one step leading to the twistor approach to TGD inspired by Yangian symmetry [?] .

## 10.2 Bootstrap approach to obtain a unitary S-matrix

This section summarizes the basic mathematical realization of the modified Feynman rules hoped to give rise to a unitary M-matrix (recall that M-matrix is product of a positive square root of density matrix and unitary S-matrix in TGD framework and need not be unitary in the general case). The basic idea is that bosonic propagators emerge as fermionic loops. The approach is bottom up and leads to a precise general formulation for how the counterpart of YM action emerges from Dirac action coupled to gauge bosons and to modified Feynman rules. An essential element of the approach is a physical formulation for UV cutoff. Actually cutoff in both mass squared and hyperbolic angle is needed since Wick rotation does not make sense in TGD framework. The UV cutoff for the hyperbolic angle as a function of p-adic length scale is somewhat ad hoc element of the model and a quantitative model for how this function could follow from the requirement of quantum criticality is formulated and discussed.

### 10.2.1 Quantitative realization of UV finiteness in terms of p-adic length scale hypothesis and finite measurement resolution

p-Adic fractality suggests an elegant realization of the notion of finite measurement resolution implying the finiteness of the ordinary Feynman integrals automatically but predicting divergences for light-like loop momenta.

#### Integration measure for loop integrals and cutoff

I have considered several options for the realization of the UV cutoff but one can argue that  $CP_2$  scale or equivalently, 2-adic length scale  $L_2$  defines the natural maximal UV cutoff in quantum TGD and corresponds to the maximal measurement resolution for momentum.

1. The cutoffs will be posed on both mass squared and hyperbolic angle. This conforms with the p-adic length scale hypothesis emerging from p-adic mass calculations and with the geometry of  $CDs$ . p-Adic length scales come as  $L_p \propto \sqrt{p}$ ,  $p \simeq 2^k$  rather than  $L_p \propto p$  as the proportionality  $T(p) = pT(CP_2)$  of the temporal distance between tips of the  $CD$  combined with Uncertainty Principle would suggest. The reason is that light-like randomness of partonic 3-surfaces means Brownian motion so that  $L_p \propto \sqrt{T(p)}$  and  $M_p \propto 1/\sqrt{T(p)}$  follows. To avoid confusions note that for the conventions that I have used  $T(p)$  corresponds to the secondary p-adic length scale  $T_{p,2} = \sqrt{p}T_p$ . For electron  $T(p)$  corresponds to .1 seconds.
2. Loops involve basically integrals of form

$$\int d^4k k^{-2n} , \quad n = 1, 2, \dots \quad (10.2.1)$$

It is far from obvious whether the usual definition based on Wick rotation of the Euclidian variant of the integral makes sense in the recent case. The definition based on Wick rotation

would eliminate the divergence in the hyperbolic angle leave only a cutoff in  $k^2 \geq 0$  and give quadratic *resp.* logarithmic divergences for  $n = 1$  *resp.*  $n = 2$ . This prescription is not favored by the picture suggested by the geometry *CDs*.

3. The most natural integration measure is just the standard  $M^4$  volume element  $d^4k$ . By introducing coordinates  $(m^0, r_M) = (\epsilon \text{acosh}(\eta), \text{asinh}(\eta))$  inside future ( $\epsilon = 1$ ) and past ( $\epsilon = -1$ ) light-cones and  $(m^0, r_M) = (\text{asinh}(\eta), \text{acosh}(\eta))$  in their complement, one can write the  $M^4$  integration measure as

$$d^4k = k^3 dk \times \sinh^2(\eta) d\eta d\Omega, \quad k^2 = k^\mu k_\mu \quad (10.2.2)$$

inside future and past light-cones and

$$d^4k = k^3 dk \times \cosh^2(\eta) d\eta d\Omega \quad (10.2.3)$$

in the complement of future and past light-cones. The integration range for  $k$  is  $(0, \infty)$  in absence of cutoff.

4. The integral in the time like region involves integration over both signs of  $k^0$ . By replacing the integrand with the sum of integrand and its time reversal the integral can be restricted to the future light-cone. It should be noticed that the integrals given mass term to the bosonic propagator do not vanish unless the cutoffs for hyperbolic angle  $\eta$  in space-like and time-like regions are related in a specific manner. The reason is that  $\sinh^2(\eta)$  in time-like region is replaced with  $\cosh^2(\eta)$  space-like region.
5. The geometry of *CDs* requires IR and UV cutoffs in both mass squared and hyperbolic angle. The simplest cutoffs that one can imagine are given by

$$p_{max}^{-1/2} \leq \frac{m}{m(CP_2)} \leq p_{min}^{-1/2}, \quad 0 \leq |\sinh(\eta)| \leq |\sinh(\eta_{max})|. \quad (10.2.4)$$

The primes  $p_{max}$  and  $p_{min}$  correspond to IR and UV cutoffs and  $p_{min} \geq 2$  holds true naturally in QFT limit since stringy excitations having mass scale given by  $CP_2$  mass are not included. This means that all loop integrals are finite. The justification for the presence of cutoff in  $|\sinh(\eta)|$  comes either from the requirement that the Lorentz transformed sub-*CDs* to which the fermion loop can be associated remain inside *CD* within the time resolution used (depending on the p-adic length scale characterizing the sub-*CD*) or by the condition that the decomposition of the gauge boson to a pair of fermion and anti-fermion at opposite wormhole throats restricts the range of the virtual momenta to momenta almost at rest in the rest system of boson. The precise form of the hyperbolic cutoff is far from obvious and it turns out that the cutoff in hyperbolic angle must be assumed to depend on p-adic length scale.

6. The worst integrals in the asymptotic region identified as a p-adic length scale range characterized by prime pair  $(p_{min}, p_{max})$  are for the naivest cutoff of form

$$\begin{aligned}
 \int \frac{1}{k^2} d^4k &= 4\pi(I_{t,2}I_t - I_{s,2}I_s) , & \int \frac{1}{k^2} d^4k &= 4\pi(I_{t,0}I_t + I_{s,0}I_s) , \\
 I_{t,2} &= \int_0^{k_{max,t}} k dk = \frac{k_{max,t}^2}{2} , & I_{s,2} &= \int_0^{k_{max,s}} k dk = \frac{k_{max,s}^2}{2} , \\
 I_{t,0} &= \int_0^{k_{max,t}} \frac{dk}{k} = \log\left(\frac{k_{max,t}}{k_{min,t}}\right) , & I_{s,0} &= \int_0^{k_{max,s}} \frac{dk}{k} = \log\left(\frac{k_{max,s}}{k_{min,s}}\right) , \\
 I_t &= 4 \int_0^{\eta_{max,t}} \sinh^2(\eta) d\eta = \sinh(2\eta_{max,t}) - 2\eta_{max,t} , \\
 I_s &= 2 \int_0^{\eta_{max,s}} \cosh^2(\eta) d\eta = \frac{1}{2}\sinh(2\eta_{max,s}) + \eta_{max,s} .
 \end{aligned}
 \tag{10.2.5}$$

The mere finiteness of these integrals requires a cutoff in hyperbolic angle besides that for mass squared.

7. For a general Feynman graph with  $I$  internal lines and  $L$  loops and involving only fermions one obtains the UV behavior

$$\mu^{4L-I}$$

in absence of cancelations and using Wick rotation to define the loop integrals. This differs from the behavior for Minkowskian integrals. Only fermionic loops with single loop and  $n \geq 2$  boson vertices in the loop appear in the the TGD variant of gauge theory involving only Dirac action coupled to gauge bosons and this gives  $\mu^{4-n}$  behavior formally for bosonic n-vertex.

### $F\overline{F}$ self energy loop for gauge boson

It is instructive to calculate the  $F\overline{F}$  self energy loop for gauge boson propagator using standard Feynman rules.

1. In the section about calculation of the gauge boson propagator it is shown that after taking the trace over the product of gamma matrices the scalar factor of the loop integral multiplying the projector to physical polarization degrees of freedom can be written as

$$X = 2 \int d^4k \frac{1}{k^2(p+k)^2} \times (3p \cdot k + \frac{(p \cdot k)^2}{p^2} + k^2) . \tag{10.2.6}$$

2. If Wick rotation is used to define loop integrals mass squared term is generated. Minkowskian integration measure is however the only sensible choice. In this case one must introduce a cutoff in both mass squared and hyperbolic angle characterizing virtual fermion momentum estimated in the rest system of virtual gauge boson. p-Adic length scale hypothesis fixes the UV and IR cutoffs for mass to be p-adic mass scales and it is natural to divide the integration range to p-adic half octaves. In hyperbolic angle the form of the cutoff is not obvious and will be discussed later. Hyperbolic cutoff is expected to depend on the p-adic mass scale. Also in this case mass term is generated unless there is a precise relationship between hyperbolic cutoff in time-like and space-like regions.
3. Why the mass term of the propagator does not vanish automatically is due to the fact that the integration measures for space-like and time-like loop momenta have different dependence on the hyperbolic angle  $\eta$ . In the section about calculation of gauge boson propagator it is found that time-like and space-like contributions cancel if the time-like and space-like cutoffs for the hyperbolic angle are related by

$$-\sinh(2\eta_{max,s}) + \frac{1}{8}\sinh(4\eta_{max,s}) - \frac{5}{2}\eta_{max,s} = -2\sinh(2\eta_{max,t}) - \frac{1}{4}\sinh(4\eta_{max,t}) + 5\eta_{max,t} \tag{10.2.7}$$

For small values of  $\eta$  this gives

$$\eta_{max,s} = \frac{4}{3}\eta_{max,t}^3 . \quad (10.2.8)$$

The expressions for the non-vanishing contributions at this limit read as

$$\begin{aligned} X &= X_t + X_s , \\ X_t &= 4\pi \int_0^{\eta_{max,t}} d\eta \times \sinh^2(\eta) i_t , \quad i_t = -12\log(2)\cosh^2(\eta) , \\ X_s &= 4\pi \int_0^{\eta_{max,s}} d\eta \times \cosh^2(\eta) j_s , \quad j_s = \frac{\log(2)}{2}(2\cosh^2(\eta) - 1)(1 - \sinh^2(\eta)) . \end{aligned} \quad (10.2.9)$$

The values of the integrals are

$$\begin{aligned} X_t &= -\frac{3\pi\log(2)}{4} [\sinh(4\eta_{max,t}) - 4\eta_{max,t}] \simeq -8\pi\log(2)\eta_{t,max}^3 , \\ X_s &= \frac{\pi\log(2)}{2} \times \left[ \frac{1}{4}\sinh(4\eta_{max,s}) + \sinh(2\eta_{max,s}) + \eta_{max,s} - \frac{1}{6}\sinh^3(2\eta_{max,s}) \right] \\ &\simeq 2\pi\log(2)\eta_{max,s} \simeq \frac{8\pi\log(2)}{3}\eta_{max,t}^3 . \end{aligned} \quad (10.2.10)$$

For small values of  $\eta_{max,t}$  both contributions behave as  $\eta_{max,t}^3$  and are of opposite sign. Time-like contribution has three times larger magnitude than space-like contribution at this limit.

4. The normalization factor for the inverse of the propagator equals to  $X$  multiplied by the sum of charges squared for fermions coupling to the gauge boson. If the cutoff in the hyperbolic angle depends on p-adic length scale, one obtains

$$\left(\frac{1}{G_B}\right)^{\mu\nu} = i [p^2 g^{\mu\nu} - p^\mu p^\nu] \times \sum_{k=1}^{k_{max}} X(k) . \quad (10.2.11)$$

Here  $\sum_i Q_i^2$  represents sum over squares of charges of fermions coupling to the gauge boson.  $k = 1, \dots, k_{max}$  labels the p-adic mass scales. Electron corresponds to  $k = 127$ . The condition  $X = \frac{1}{4\pi\alpha_{em}(127)}$  poses a strong condition on the parameters of the model of hyperbolic cutoff  $\eta_{max,t}(k) = f(k)$ .

5. There is consistency with gauge invariance if the contraction of the propagator with  $p^\mu$  vanishes. This is true if the hyperbolic cutoffs in time-like and space-like region satisfy the proposed relationship. The result is very similar to what one would expect in quantum field theory so that the finite measurement resolution would not mean any dramatic effect on the propagator. The limit  $p_{min} = 2$  would correspond to a maximal UV cutoff defined by the  $CP_2$  mass scale.

The conclusion is that the definition of loop integrals as Euclidian integrals would lead to a catastrophe via the generation of gauge boson mass proportional to the cutoff mass whereas the Minkowskian definition with the notion of cutoff motivated by p-adic length scale hypothesis and hierarchy of  $CDs$  keeps gauge bosons massless if space-like and time-like hyperbolic cutoff are in a precise relationship and the only contribution to mass comes from mass terms in the fermionic propagators.

**Could bosonic propagators emerge?**

The following argument suggests that emergent bosonic propagation is a mathematically consistent notion and conforms with the special features of quantum TGD.

1. In basic quantum TGD modified Dirac equation containing induced spinor connection as induced gauge boson field defines the theory and the exponent of Kähler action emerges as Dirac determinant. The natural guess is that this structure is preserved in the sense that Feynman diagrammatics is defined by Dirac action coupled to gauge potentials but containing no kinetic term for gauge potentials with kinetic terms emerging from the fermionic loops and the values of gauge couplings following as predictions of the formalism.
2. One can try to formulate this idea in terms of path integral formalism. Couple gauge bosonic field  $A$  resp. Grassmann valued fermion fields  $\Psi$  to external currents  $j$  resp. Grassmann valued external currents  $\xi$  and calculate the functional Fourier transform defined by the path integral

$$Z(j, \xi, \bar{\xi}) = \exp(G_c(j, \xi, \bar{\xi})) \equiv \int \exp \left[ iS(A, \Psi, \bar{\Psi}) - i \int (jA + \bar{\xi}\Psi + \bar{\Psi}\xi) \right] DAD\Psi D\bar{\Psi} . \tag{10.2.12}$$

Here  $G_c$  is the generating functional of connected Green's functions defined as a functional integral of Dirac action coupled to gauge potentials over  $\Psi$  and  $A$ . The functional derivatives of the effective action with respect to the  $\xi, \bar{\xi}$  and  $j$  at  $(j = 0, \xi = 0, \bar{\xi} = 0)$  give the connected N-point functions.

One can also perform Legendre transform

$$\begin{aligned} i\Gamma(A, \Psi, \bar{\Psi}) &= G_c(j, \xi, \bar{\xi}) - i \int \left[ jA + \bar{\Psi}\xi + \int \bar{\xi}\Psi \right] , \\ A &= -i \frac{\delta}{\delta j} G_c , \quad \Psi = -i \frac{\delta}{\delta \xi} G_c , \quad \bar{\Psi} = i \frac{\delta}{\delta \bar{\xi}} G_c . \end{aligned} \tag{10.2.13}$$

to obtain the effective action  $\Gamma$ .

3.  $G_c$  can be calculated in two steps.
  - (a) At the first step one divides the Dirac action in presence of gauge field to free part and interaction term

$$\exp(iS(\Psi, \bar{\Psi}, A)) = \exp \left[ i\bar{\Psi}\gamma^\mu \partial_\mu \Psi + i \int \bar{\Psi}\gamma^\mu A_\mu \Psi \right] . \tag{10.2.14}$$

Gauge couplings have been included to gauge potentials since there is no manner to separate them uniquely in absence of the kinetic term. The path integral can be carried out perturbatively by using the general formula

$$\exp(S_c(A, \xi, \bar{\xi})) = \exp \left[ i \int \frac{\delta}{\delta \bar{\xi}} \gamma \cdot A \frac{\delta}{\delta \xi} \right] \times \exp [i\bar{\xi}G_F\xi] . \tag{10.2.15}$$

and Wick's reduction formulas.  $G_F$  fermionic Feynman propagator. This functional power series gives what can be regarded as a generating functional  $S_c(A, \xi, \bar{\xi})$  for connected Green's functions of spinor fields in the presence of external gauge fields or the analog of YM action induced by the presence of external spinor fields.

- (b) At the next step one can calculate the full generating functional  $G_c(j, \xi, \bar{\xi})$  for connected Green's functions using again the general reduction formulas by decomposing  $S_c(A, \xi, \bar{\xi})$  to a free part  $S_0(A)$  analogous to the linear part of YM action and interacting part  $S_{int}(A, \xi, \bar{\xi})$

$$S_c(A, \xi, \bar{\xi}) = S_0(A) + S_{int}(A, \xi, \bar{\xi}) . \quad (10.2.16)$$

$S_0$  defines the bosonic kinetic term which is of correct form by the preceding observations. The interaction terms for  $A$ ,  $\xi$ , and  $\bar{\xi}$  are included in  $S_{int}$ . Since the original system is gauge invariant also the effective action must be gauge invariant and should reduce to Yang-Mills action in the lowest orders. Perturbation theory is therefore possible and one can perform the path integral over  $A$  using the induced propagators and vertices. At this step fields  $\xi$  are in the role of non-dynamical external fields just as  $A$  was at the first step and all propagators are bosonic. From the resulting "partition function"  $Z$  one can generate connected N-point functions as functional derivatives with respect to the sources.

- (c) It seems that the proposed description avoids the most obvious divergences. In particular, the tadpole term from  $A_\mu \bar{\Psi}(x) \gamma^\mu \Psi(x)$  proportional to the fermion propagator  $D_F(x, x)$  proportional to an integral of form  $\int d^4 k k^\mu / k^2$  and thus vanishing.
- (d) The bosonic kinetic term would be proportional to the over all gauge coupling  $g^2$  if one expresses gauge potential in the form  $gA$ . This decomposition is however not natural in TGD since the induced spinor connection corresponds to  $gA$  with no explicit value of  $g$  being specified. In the case of simplest tree diagram describing  $2 \rightarrow 2$  fermion scattering that the  $g^2$  coming from the ends of the boson line is canceled by the  $1/g^2$  coming from the bosonic propagator so that the predictions of the theory do not depend on the value of  $g$  in the lowest order. This looks strange but would conform with the absence of bosonic kinetic term in the primary action making it impossible to identify the value of  $g$  in standard manner. One can however say that the numerical coefficient given by the fermionic loop integrals defining the bosonic propagator predicts the values of gauge couplings  $g$  through the comparison of their values with the prediction of standard gauge theory for say  $2 \rightarrow 2$  scattering. This picture would conform with the vision that TGD predicts all gauge couplings. Maybe the emergence of gauge boson propagators and vertices could be seen as one aspect of quantum criticality.

These arguments suggest that the notion of emergent gauge boson propagation makes sense mathematically and is favored also by the general structure of quantum TGD. Of course, the best strategy is the attempt to debunk the notion once and for all. Consistency with p-adic mass calculations might provide the needed killer argument.

1. The resulting bosonic mass squared would be in the lowest order sum over products of masses of fermion pairs coupling to the boson. It is far from clear whether this prediction is quantitatively consistent with the predictions of the p-adic mass calculations. This possibility is not of course excluded: boson mass squared is quadratic in fermion masses coupling to the boson and the p-adic primes associated with the fermions are naturally those associated with the boson rather than free fermions so that at least the mass scale comes out correctly. This picture conforms also qualitatively with the fact that mass squared is identified as conformal weight and the eigenvalue of modified Dirac operator related closely to the ground state contribution to the mass can be regarded as complex squares root of conformal weight.
2. Note that even photon is predicted to be massive unless the fermion and antifermion associated with photon and other massless particles are massless or in so low p-adic temperature that the thermal mass is negligible. Also the p-adic prime associated with massless bosons could be so large that the mass is small.
3. Boson masses are of course emergent in the sense that they are determined by the masses of the fermion and anti-fermion, which they consist of. The question is whether the emergence of masses takes place via loops rather than p-adic mass calculations in the proposed sense and whether these pictures are equivalent. That loops could provide the fundamental description for boson masses is suggested by the asymmetry between bosons and fermions in the recent form of



p-adic mass calculations. The p-adic temperature for bosons must be  $T_p \leq 1/2$  whereas  $T_p = 1$  holds true for fermions, and for fermions the analog of Higgs contribution is negligible whereas for gauge bosons it dominates.

4. It could be also possible to code p-adic thermodynamics into the Feynman diagrammatics in a more refined manner so that loops would give only corrections to the masses obtained from p-adic mass calculations. Instead of simply feeding in the results of p-adic mass calculations as mass parameters of the fermionic propagators, one could replace S-matrix with M-matrix involving the square root of density matrix describing the real counterpart of the partition function characterizing p-adic thermodynamics. Zero energy state would represent a square root of thermodynamical ensemble involving massless ground states and their conformal excitations rather than only ground states with thermal masses.

### The emergence of the fermionic and bosonic propagators at fundamental level

It took quite a long time to understand how stringy fermionic propagator emerges from quantum TGD. The problem was that the fermion propagator  $1/D$  defined by the modified Dirac operator assigned to Kähler action does not depend on momentum at all.

1. The resolution of the problem [K15, ?] was based on the addition of a general coordinate invariant and Poincare invariant measurement interaction coupling fermionic currents to the Cartan charges of the isometry group of  $M^4 \times CP_2$  (note that Poincare group allows two types of 4-D Cartan algebras corresponding to linear and cylindrical Minkowski coordinates). The coupling occurs only at wormhole throats and involves Chern-Simons Dirac action and corresponding measurement interaction terms in accordance with the interpretation of wormhole throats as lines of the generalized Feynman diagrams. For vanishing momenta topological QFT results.
2. Also the measurement interactions for general observables can be represented in terms of this kind of couplings by utilizing the infinite hierarchy of conserved fermionic currents and their classical counterparts implied by quantum criticality realized as a vanishing of infinite number of second variations of Kähler action for preferred extremals. The critical deformations for Kähler action are special cases of the deformations for which the second variation of Chern-Simons action vanishes for each light-like 3-surface  $Y_l^3$  in the slicing of space-time sheet by light-like 3-surfaces parallel to the wormhole throat  $X_l^3$  and are therefore orthogonal to the Kähler magnetic field at each  $Y_l^3$ .
3. Quantum criticality states that the couplings induce only a  $U(1)$  gauge transformation of the Kähler function of WCW identified as Dirac determinant:  $K \rightarrow K + f + \bar{f}$ , where  $f$  is holomorphic function of WCW complex coordinates and arbitrary function of zero mode coordinates. This condition is expected to fix the values of the coupling parameters appearing in the measurement interaction. In particular, the values of gravitational constant and gauge couplings are expected to be dictated by this condition. p-Adic coupling constant evolution corresponds to the hierarchy of  $CDs$  whose size scales are assumed to come as powers of 2.
4. One can say that fermionic propagators emerge from the measurement interaction for momentum since in absence of the measurement interactions reducing to the measurement of momenta the theory reduces to a topological QFT involving only color Cartan charges. Also measurement interaction for longitudinal part of 4-momentum, spin, and rapidity is possible and the formalism of high energy hadron physics can be interpreted in terms of this measurement interaction.
5. One can define bosonic propagators by performing a path integral over fermionic loops identified as wormhole contacts with fermion and antifermion at opposite light-like throats and functional integral over WCW degrees of freedom (small deformations of wormhole throats). After that one can calculate bosonic loops- most naturally by using generalized Cutkosky rules and the generalization of twistor approach to 8-D context. The mere fact that fermion and antifermion are constrained to the throats of the wormhole contact suggests natural cutoffs for the mass squared and hyperbolic angle of virtual fermions so that divergences are expected to be absent in the fundamental theory even without the cutoff due to the finite measurement resolution. From the fermionic Feynman propagator and its bosonic counterpart one can therefore build all

diagrams (no fermionic loops at this level are present) and get finite results. The finiteness of the fundamental fermionic loops justifies the cutoffs for mass squared and hyperbolic angle forced by the finite measurement resolution.

One could of course worry whether the introduction of the p-adic length scale hierarchy might lead to problems with analyticity and unitarity. I am also the first one admit that the proposed scenario looks horribly ugly against the extreme elegance of gauge theories like  $N = 4$  SYM. The tough challenge is to find an elegant mathematical realization of the proposed physical picture and twistor approach generalized to 8-D context might be of considerable help here.

### 10.2.2 A more detailed summary of Feynman diagrammatics

The resulting Feynman diagrammatics deserves some more detailed comments.

1. Consider first the exponent of the action  $\exp(iS_c)$  resulting in fermionic path integral. The exponent

$$\exp\left[i \int d^4x d^4y \bar{\xi}(x) G_F(x-y) \xi(y)\right] = \exp\left[i \int d^4k \bar{\xi}(-k) G_F(k) \xi(k)\right]$$

is combinatorially equivalent with the sum over n-point functions of a theory representing free fermions constructed using Wick's rules that is by connecting  $n$  Grassmann spinors and their conjugates in all possible ways by the fermion propagator  $G_F$ .

2. The action of

$$\exp\left[i \int d^4x \frac{\delta}{\delta \bar{\xi}(x)} \gamma \cdot A(x) \frac{\delta}{\delta \xi(x)}\right] = \exp\left[i \int d^4k d^4k_1 \frac{\delta}{\delta \bar{\xi}(k-k_1)} \gamma \cdot A(-k) \frac{\delta}{\delta \xi(k_1)}\right]$$

on diagrams consisting of  $n$  free fermion lines gives sum over all diagrams obtained by connecting fermion and anti-fermion ends of two fermion lines and inserting to the resulting vertex  $A(-k)$  such that momentum is conserved. This gives sum over all closed and open fermion lines containing  $n \geq 2$  boson insertions. The diagram with single gauge boson insertion gives a term proportional to  $A_\mu(k=0) \cdot \int d^4k k^\mu k^{-2}$ , which vanishes.

3.  $S_c$  as obtained in the fermionic path integral is the generating functional for connected many-fermion diagrams in an external gauge boson field and represented as sum over diagrams in which one has either closed fermion loop or open fermion line with  $n \geq 2$  bosons attached to it. The two parts of  $S_c$  have interpretation as the counterparts of YM action for gauge bosons and Dirac action for fermions involving arbitrary high gauge invariant n-boson couplings besides the standard coupling. An expansion in powers of  $\gamma^\mu D_\mu$  is suggestive. Arbitrary number of gauge bosons can appear in the bosonic vertices defined by the closed fermion loops and gauge invariance must pose strong constraints on the bosonic part of the action if expressible in terms of bosonic gauge invariants. The closed fermion loop with  $n = 2$  gauge boson insertions defines the bosonic kinetic term and bosonic propagator. The sign of the kinetic terms comes out correctly thanks to the minus sign assigned to the fermion loop.
4. Feynman diagrammatics is constructed for  $S_c$  using standard Feynman rules. In ordinary YM theory ghosts are needed for gauge fixing and this seems to be the case also now.
5. One can consider also the presence of Higgs bosons. Also the Higgs propagator would be generated radiatively and would be massless for massless fermions as the study of the fermionic self energy diagram shows. Higgs would be necessary  $CP_2$  vector in  $M^4 \times CP_2$  picture and  $E^4$  vector in  $M^8 = M^4 \times E^4$  picture. It is not clear whether one can describe Higgs simply as an  $M^4$  scalar. Note that TGD allows in principle Higgs boson but - according to the recent view - it does not play a role in particle massivation.

**Some differences from standard Feynman diagrammatics**

The diagrammatics differs from the Feynman diagrammatics of standard gauge theories in some respects.

1. 1-P irreducible self energy insertions involve always at least one gauge boson line since the simplest fermionic loop has become the inverse of the bosonic propagator. Fermionic self energy loops in gauge theories tends to spoil asymptotic freedom in gauge theories. In the recent case the lowest order self-energy corrections to the propagators of non-abelian gauge bosons correspond to bosonic loops since fermionic loops define propagators. Hence asymptotic freedom is suggestive.
2. The only fundamental vertex is  $AF\bar{F}$  vertex. As already found, there seems no point in attaching to the vertex an explicit gauge coupling constant  $g$ . If this is however done n-boson vertices defined by loops are proportional to  $g^n$ . In gauge theories n-boson vertices are proportional to  $g^{n-2}$  so that a formal consistency with the gauge theory picture is achieved for  $g = 1$ . In each internal boson line the  $g^2$  factor coming from the ends of the bosonic propagator line is canceled by the  $g^{-2}$  factor associated with the bosonic propagator. In S-matrix the division of the bosonic propagator from the external boson lines implies  $g^n$  proportionality of an n-point function involving  $n$  gauge bosons. This means asymmetry between fermions and bosons unless one has  $g = 1$ .  $g = 1$  above means  $g = \sqrt{\hbar_0}$ . Since fermionic propagator is proportional to  $\hbar_0^0$  and since loop integral involves the factor  $1/\hbar_0$ , the dimensions of bosonic propagator and radiatively generated vertices come out correctly. The counterparts of gauge coupling constants could be identified from the amplitudes for 2-fermion scattering by comparison with the predictions of standard gauge theories. The small value of effective gauge coupling  $g$  obtained in this manner would correspond to a large deviation of the normalization factor of the radiatively generated boson propagator from its standard value.
3. Furry's theorem holding true for Abelian gauge theories implies that all closed loops with an odd number of Abelian gauge boson insertions vanish. This conforms with the expectation that 3-vertices involving Abelian gauge bosons must vanish by gauge invariance. In the non-abelian case Furry's theorem does not hold true so that non-Abelian 3-boson vertices are obtained.

**Is it possible to understand the value of fine structure constant?**

The basic test for the theory is whether it can predict correctly the value of fine structure constant for reasonable choice of the UV and IR cutoffs. In the first approximation one can assume that photons has only  $U(1)$  couplings to fermions so that the fermion-fermion scattering amplitude at electron's p-adic length scale is determined by the photon propagator alone.

The expansion in powers of  $p^2 - 2p \cdot k$  gives at the limit  $p^2 = 0$  the following estimate for the normalization factor of the inverse of the Abelian gauge boson propagator using 2-adic scale  $p_{min} = 2$  as UV cutoff.

$$\begin{aligned}
 \left(\frac{1}{G_B}\right)^{\mu\nu} &= i [p^2 g^{\mu\nu} - p^\mu p^\nu] \times X \ , \\
 X &= \sum_k [2G^t(\eta_{max,t}(k)) + G^s(\eta_{max,s}(k))] \times \log(2) \times 2\pi \sum_i Q_i^2 \ , \\
 G^t(\eta) &= -\frac{1}{4}\eta + \frac{1}{4}\sinh(2\eta) + \frac{1}{16}\sinh(4\eta) \ , \\
 G^s(\eta) &= +\frac{1}{4}\eta + \frac{1}{4}\sinh(2\eta) - \frac{1}{16}\sinh(4\eta) \ .
 \end{aligned}
 \tag{10.2.17}$$

Here  $\sum_i Q_i^2$  represents sum over squares of charges of fermions coupling to the gauge boson. For three lepton and quark generations one would have  $\sum_i Q_i^2 = 16$ . Here the same hyperbolic cutoff is assumed for both time-like and space-like momenta. The basic ad hoc element of the model is the choice of the cutoff in hyperbolic angle  $\eta$  and one can consider several trials.

The basic a hoc element is the physical interpretation and precise form of the hyperbolic cutoff.

1. The realization of the cutoff for the mass of the virtual particle in terms of p-adic mass scale  $m \leq m(CP_2)/\sqrt{p}$  is on a strong basis. The ad hoc assumption is the form  $|\sinh(\eta)| \leq p_{min}^{-1/2}$  for the cutoff in the hyperbolic angle. The cutoff means that the allowed range of 3-momenta for time-like momenta and of energies for time-like momenta of off mass shell particle is rather narrow for a given mass. What is clear is that any extension of the allowed phase space increases the value of  $X$  and requires larger  $p_{min}$  for this form of cutoff.
2. The narrow cutoff in the fermionic loop momenta could be interpreted physically in terms of the fermion-anti-fermion bound state character of bosons restricting the range of the virtual momenta of the fermion and anti-fermion to a very narrow range in the rest system of the boson. This is natural if fermion and antifermion reside at the opposite throats of the wormhole contact. In the case of virtual bosons radiated by leptons this restriction would not apply.
3. There is also second interpretation for the narrow cutoff. The rest system of sub- $CD$  in which the fermionic loop is calculated is assumed to be the rest system of the virtual particle. Otherwise one would obtain a breaking of Lorentz invariance. This requirement could provide an alternative justification for the cutoff in  $\cosh(\eta)$  since for too large values of  $\eta$  identified as the hyperbolic angle assignable to the lower tip of sub- $CD$  the Lorentz transform of the time coordinate  $T(p) = pT(CP_2)$  of the upper tip of sub- $CD$  is  $T = \cosh(\eta) \times pT(CP_2)$ , and could be so large that the upper tip belongs outside  $CD$ .

### 1. First trial

The first cutoff that comes in mind would be given by constant hyperbolic cutoff  $\sinh(\eta_{max}(k)) = a/\sqrt{p_{min}}$  and thus would depend on the UV cutoff length scale only. This cutoff would predict logarithmic dependence of form  $1/\alpha_{em} = \log(k_{max}/k_{min})$  on IR cutoff  $k_{max}$  and predict  $\alpha_{em}(127)/\alpha_{em}(89) = \log(127/89) \simeq .3556$  to be compared with the experimental value of about  $128/137$  so that the coupling constant evolution would be too fast.

### 2. Second trial

The first cutoff predicts too fast coupling constant evolution. Second cutoff can be seen representing another extreme.

1. For the cutoff of form

$$\cosh(\eta_{max}(k)) \leq 1 + a \times 2^{-k} \quad (10.2.18)$$

the maximal variation of the temporal distance between the tips of the Lorentz transformed  $CD$  is in good approximation  $\Delta T = (\cosh(\eta_{max}(k)) - 1)T(k) \simeq aT(CP_2)$ . For  $a < 2$   $\Delta T$  is below the optimal time resolution defined by the 2-adic time scale  $2T(CP_2)$  everywhere inside  $CD$ . Number theoretical universality favors simple rationals as values of  $a$ . The only p-adically problematic feature is the appearance of  $\log(2)$  factor in the integral. In the case of electron length scale the sum is from  $k_{min} = 1$  to  $k_{max} = 127$ . The sums are expressible in terms of geometric series for powers of  $2^{-nk}$ ,  $n = 1, \dots, 5$  and can be carried out explicitly. The fatal problem of this option is that coupling constant evolution with respect to IR cutoff is trivial except immediately above the cutoff length scale.

### 3. Third trial

The basic criticism against the second trial is the approximate RG invariance only few octaves above UV cutoff due to the exponential decrease of loop corrections as a function p-adic length scale. Since the cutoff in hyperbolic angle is introduced in ad hoc manner one can ask whether one could fix the form of UV cutoff as a function of p-adic length scale by requiring the typical logarithmic evolution of fine structure constant in all length scales.

1. The cutoff in hyperbolic angle allowing to achieve this should depend on the logarithm of the p-adic length scale and in the simplest situation of the form

$$|\sinh(\eta) \leq a \times k^{-b} \quad , \tag{10.2.19}$$

where the proper time distance between the tips of  $CD$  is given by  $T = 2^k T(CP_2)$ . Note that the condition is equivalent with  $|\sinh(\eta)| \leq \sqrt{ab}^{a/2}$ .  $b = 1/3$  is favored as the Table 1 below shows. This is perhaps not too surprising since it implies that the contribution of p-adic length scale  $p \simeq 2^k$  to  $X$  is proportional to  $1/\log(p)$  since the contribution in good approximation scales as  $\eta_{l,max}^3(k)$ . The condition would state that the time scale resolution is roughly  $aT(2, k)/2k^b$  in the time scale defined by  $k$  so that Lorentz boosts increasing the time difference is measured in rest system with at most this amount are allowed even if they lead out from the  $CD$  containing the sub- $CD$  in question. Physically this resolution looks reasonable since it is smaller than p-adic time scale but of same order of magnitude. For prime values of  $k$  one could interpret the  $k^{-b}$  proportionality as dependence on the p-adic length scale  $L_k = \sqrt{k}T(CP_2)$  characterizing the size of the wormhole throats associated with the gauge boson.

2. The basic constraints on the parameters come from the assumption that the evolution of the fine structure constant is in the first approximation due to the evolution of IR resolution time scale fixed by  $k_{max}$ . This gives the condition  $\alpha(127)/\alpha(89) \simeq 137/128$  from which two constraints between  $a$  and  $b$  can be deduced. A further consistency constraint is that the value of the fine structure constant in  $CP_2$  length scale is sensible.
3. The evolution of non-Abelian gauge couplings would be essentially due to the bosonic loops and should induce the increase of these couplings as a function of p-adic length scale since purely fermionic loops are absent. The dependence of gauge coupling on  $p^2$  is predicted to be non-trivial since the logarithmic factors do not remain effectively constant anymore so that there are good hopes about a realistic coupling constant evolution. An interesting implication is the presence of sizable pole contributions in hyperbolic integrals from points  $\epsilon_1 m_k \exp^{\epsilon_2 \eta} = p/m_k$  and logarithmic principal values singularities at points  $\exp^{\pm \theta} = p/m_k$  ( $m_k = 2^{-k/2} m(CP_2)$ ) appearing in the arguments of logarithms. For long p-adic length scales these singularities correspond rather precisely to p-adic mass scale  $m_k$ . These contribution could be interpreted as genuinely p-adic effects.
4. The numerical calculations can be performed in exactly the same manner as for the simplest model. At  $p^2 = 0$  limit  $b = 1/3$  and  $a = 0.22050469512552$  allows to reproduce the value of fine structure constant at electron length scale ( $k_{max} = 127$ ) within the experimental accuracy and predicts  $1/\alpha_{em}(89) = 128.163120743053$  at the intermediate boson mass scale ( $k_{min} = 89$ ). In optimistic mood one could see this prediction as an indication that the model is on the right track. For  $k_{max} = 2$  the prediction is  $1/\alpha_{em}(2) = 38.73463833489691$ . As a matter fact,  $k = 1/3$  implies that k:th contribution to  $X$  which proportional to  $\eta^3$  in good approximation is proportional to integer power of  $\log(p)$ ,  $p \simeq 2^k$ . Therefore analyticity in with respect to 2-adic logarithm of p-adic length scale could replace the value of the fine structure constant at the intermediate gauge boson length scale as input.

b	a	$\alpha_{em}^{-1}(89)$	$\alpha_{em}^{-1}(2)$
1/2	0.18002740466919	135.1862478534053	78.00163838242398
1/4	0.28690612308508	121.5583749750381	22.20718277558686
$\Phi/2 = (\sqrt{5} - 1)/4$	0.20889716262974	126.426555831784	33.042736628492
$\frac{5}{16}$	0.21057652266440	126.686675364275	33.770607770943
$\frac{1}{3}$	0.22050469512552	128.163120743053	38.271945363874

Table 1. The table gives the values of the inverse of the fine structure constant at intermediate boson length scale ( $k = 89$ ) and at UV limit ( $k = 2$ ) for 5 different values of parameter  $b$  characterizing the UV cutoff. The value of  $a$  is deduced from the condition that fine structure constant in electron

length scale ( $k = 127$  is reproduced correctly.  $b = 1/3$  produces fine structure constant at intermediate boson length scale within experimental and theoretical uncertainties.

**The predictions for other gauge couplings**

One can also look for the predictions for color and electro-weak coupling constants.

1. The loop is proportional to  $N(B_i) = Tr(Q_i^2)$ . The charge matrices are  $I_L^i$  for  $W$  bosons and  $I_L^3 - pQ_{em}$ ,  $p = \sin^2(\theta_w)$  for  $Z^0$ . For the coupling of Kähler gauge potential the charge matrix is  $Q_K = 1$  for leptons and  $Q_K = 1/3$  quarks: it is easy to see that in this case the normalization factor is same as photon. The traces of non-Abelian charge matrices in fundamental representations are  $Tr(T_a^2) = -1/2$  in the standard normalization. For photon and gluons both right and left handed chiralities contribute and  $W$  bosons only left handed.
2. This gives the following expressions for the normalization factors  $N(B_i)$

$$\alpha(B_i) = \frac{N(\gamma)}{N(B_i)} \times \alpha_{em} \quad , \tag{10.2.20}$$

$$\tag{10.2.21}$$

with

$$N(\gamma) = N(U(1)) = 16 \quad , \quad N(g) = 6 \quad , \quad N(W) = 6 \quad , \quad N(Z) = 6 - 12p + 13p^2 \quad . \tag{10.2.22}$$

The values of the gauge couplings strengths are given by

$$\alpha(g) = \frac{8}{3}\alpha_{em} \quad , \quad \alpha(W) = \frac{8}{3}\alpha_{em} \quad , \quad \alpha(Z) = \frac{16}{6-12p+13p^2}\alpha_{em} \quad . \tag{10.2.23}$$

Electro-weak couplings are unified only if one has  $p = 12/13$ , which differs dramatically from  $p = 3/8$  obtained by definition the ratio  $\alpha_e m / \alpha_W$ , which is also the typical prediction of GUTs.

3. The table below summarizes the predictions for the bare couplings at  $p^2 = 0$  limit for photon and using  $k = 2$  scale as cutoff for the above described model characterized by the parameter  $b$  in  $\sinh(\eta_{max,t}) = a \times k^{-b}$  with  $a$  fixed by the condition that fine structure constant at electron length scale is reproduced within experimental precision.  $b = 1/3$  predicts smallest value for  $\alpha_s$  and  $1/\alpha_s(2) = 14.5255$  is consistent with  $1/\alpha_s(89) \simeq 10$ .

b	$\alpha_{em}^{-1}(2)$	$\alpha_s^{-1}(2)$	$\alpha_W^{-1}(2)$	$\alpha_Z^{-1}(2)$
1/2	78.0016	28.8792	28.8792	16.0189
1/4	22.2072	8.2537	8.2537	4.5782
$\Phi/2$	33.0427	12.5313	12.5313	7.1049
5/16	33.7706	12.8088	12.8088	7.1049
1/3	38.2719	14.5255	14.5255	8.0571

Table 2. The predictions for the bare gauge coupling strengths at the UV limit  $k = 2$  assuming  $M_{127}$  as IR cutoff and  $p = 2$  as UV cutoff and using the value of parameter  $a$  reproducing the values of fine structure constant at electron and intermediate boson p-adic mass scale.

### Cutoff in the general case

The previous calculations were carried by identifying the UV cutoff as 2-adic length scale. The calculations can be generalized to an UV cutoff defined by any p-adic length scale with  $p_{min} \simeq 2^{k_{min}}$ . The Lorentz transforms of sub-*CDs* must belong inside *CD* within measurement resolution. For the third trial one would have

$$\sinh(\eta_{t,max}) = a \times (k - k_{min} + 1)^{-b} . \quad (10.2.24)$$

The first guess for the values of  $a$  and  $b$  having are the values for  $k_{min} = 1$ .  $k \geq k_{min}$  holds of course true.

The definition of the UV cutoff for vertex corrections involves a delicacy.

1. In the vertex correction for *FFB* vertex the ends of the virtual boson line in general correspond to fermions with different four-momenta and the hyperbolic angle  $\eta$  must be assigned to the rest system of either initial or final state fermion. The choice means a selection of the arrow of geometric time and breaking of *T* invariance. The requirement of *CPT* symmetry is expected to fix the choice.
2. Similar situation is encountered also in basic quantum TGD. In the construction of the counterpart of stringy diagrammatics the CP breaking instanton variant of Kähler action contributes to the modified Dirac action a term whose appearance in the vertices makes the theory non-trivial [K17] . One must decide, which end of the line carries the CP breaking *CP* term. *CPT* invariance is the natural constraint on the choice. The idea about fermions (anti-fermions) as particles propagating to the geometric future (past) suggests that CP breaking term is associated with the negative energy fermion (positive energy anti-fermion) at the future (past) end of the line. CP symmetry is broken since CP takes fermion to anti-fermion but does not permute the end of the lines. *CPT* is respected.
3. In the recent case the counterpart of CP and T breaking would be the assignment of the cutoff to the past (future) end in the case of fermions (antifermions). If one assigns the cutoff in both cases to (say) future end, *CPT* breaking results. It is important to notice that the distinction between future and past is always unique in the rest system of the sub-*CD*.
4. For instance, in N-vertices one must sum over all cyclic permutations with one of the vertices defining the rest system in which  $\eta$  is measured, which means modification of standard QFT picture.

### The hierarchy of Planck constants and radiative corrections

TGD predicts a hierarchy of Planck constants and the question concerns the dependence of the loop corrections on  $\hbar$ . Consider first a naive argument which does not consider the anatomy of the pages of the book like structure defining the generalized imbedding space.

1. Unless the p-adic cutoff for  $\cosh(\eta)$  depends on  $\hbar$ , boson propagator cannot involve  $\hbar$ , and this is achieved by putting  $g = \sqrt{\hbar}$  so that  $1/\hbar$  factor associated with the loop cancels  $g^2 = \hbar$ . This seems means that loops give no powers of  $1/\hbar$  as in ordinary quantum field theories. By checking a sufficient number of diagrams one can get convinced that the  $\hbar$  dependence of the diagram depends on the total number of particles involved with the diagram and is given by the proportionality  $\hbar^{(N_{in} + N_{out})/2 - 1}$ .
2. This simple dependence of the amplitudes on  $\hbar$  suggests that it has actually no physical content. The scaling of the incoming and outgoing wave functions by  $\hbar^{-1/2}$  and the division of the amplitude by  $\hbar$  indeed makes the amplitudes independent of  $\hbar$ . In unitarity conditions the  $1/\hbar$  factors from  $d^3k/2E$  factors assignable to intermediate states correspond to the  $\hbar^{-1/2}$  factors of the states involved. Therefore QFT limit defined in this manner would not distinguish between different values of  $\hbar$  and the difference is seen only at the level of kinematics ( $1/\hbar$  scaling of the frequencies and wave-vectors for a fixed four-momentum). The difference would become dynamically visible through the fact that the space-time surfaces associated with *CDs* with different values of  $\hbar$  are not simply scaled up versions of each other.

3. This result is in contrast with the standard QFT expectations about how the amplitudes should behave as functions of  $\hbar$ . One of the motivations for the hierarchy of Planck constants was that radiative corrections come in powers of  $1/\hbar$  so that large values of Planck constant improves the convergence of the perturbation series in powers of coupling constant strengths. If coupling constants emerge in the proposed manner, this motivation for large values of Planck constants is lost.

That Nature would take itself care that perturbation theory works by making a phase transition increasing  $\hbar$  and thus reducing the value of the gauge coupling strength is too attractive to be given up without fighting back. What could go wrong with the above argument is that it did not take into account the topological structure of the pages of the generalized imbedding space.

1. Recall that the generalized imbedding space has a book like structure with pages defined by Cartesian products of singular coverings and factor spaces of  $CD \subset M^4$  and  $CP_2$  ( $CD$  denotes the causal diamond defined as an intersection of future and past directed light-cones of  $M^4$ ). The coverings are labeled by an integer characterizing the number of sheets permuted by  $Z_n$  symmetry and factor spaces by an integer giving the number of points identified under  $Z_n$  symmetry. It is convenient to label them by a single number  $x$  having as its values positive integers and their inverses. Depending on whether a covering or factor space is involved, one has for  $M^4$   $x_a = n_a$  or  $x_a = 1/n_a$  and for  $CP_2$   $x_b = n_b$  or  $x_b = 1/n_b$ .
2. The inverse of the gauge boson propagator is by definition proportional to the inverse of the gauge coupling strength  $g^2/4\pi\hbar$  and therefore can be used to define Planck constant. The manner how the inverse propagator depends on the numbers  $x_a$  and  $x_b$  dictates the dependence of the Planck constant on these numbers.
3. QFT limit involves projection of all sheets of the covering to single sheet. Therefore one can argue that the inverse propagator at QFT limit should be proportional to  $n_a n_b$  if both  $M^4$  and  $CP_2$  correspond to coverings. This would reflect the that the kinetic part of bosonic action is simply a sum over identical terms from all pages of the covering. This would imply the general formula  $\hbar/\hbar_0 = x_a x_b$  giving  $\alpha = \alpha_0/x_a x_b$ . By increasing the number of sheets of coverings in  $M^4$  and  $CP_2$  degrees of freedom system would manage to remain in perturbative phase. The structure of physical states would of course change [?] .
4. The earlier argument for how the Planck constant depends on  $n_a$  and  $n_b$  [K25] was based on different definition of Planck constant and did not lead to quite the same prediction.
  - (a) The hypothesis inspired by Schrödinger equation was that the scaling factor of  $M^4$  metric at given page of the book is proportional to  $\hbar$ : this implies that Kähler action for preferred extremals codes for radiative corrections classically. This assumption guarantees that quantal length scales are proportional to  $\hbar$ .
  - (b) This requires that  $M^4$  covariant metric scales as  $x_a^2$ . It was assumed that  $CP_2$  metric scales in the same manner- that is as  $x_b^2$  but this was just a natural looking extrapolation from  $M^4$  case. The scale invariance of the Kähler action implying that one always re-scale the overall metric in such a manner that  $CP_2$  metric remains unchanged gives  $\hbar/\hbar_0 = x_a/x_b$  to be compared with  $\hbar = x_a x_b$  given by the above argument.
  - (c) If one however assumes that  $CP_2$  covariant metric scales as  $1/x_b^2$  rather than  $x_b^2$ , one obtains  $\hbar/\hbar_0 = x_a x_b$ . This modification is possible and has no implications concerning the predictions of the theory since there is a complete symmetry under the exchange covering space  $\leftrightarrow$  factor space. The only implication is tedious retyping of some basic formulas.

If the phase transitions changing Planck constant have a QFT type description it must be based on a 2-vertex proportional to the inverse of the fermionic propagator. If so, the fermionic kinetic term would be obtained by multiplying Dirac operator with a unitary matrix characterizing the transition amplitudes between sectors labeled by different values of Planck constant. CKM mixing would represent a highly analogous situation.



### Worrying about coupling constant evolution

Before starting to worry, some general comments about coupling constant evolution are in order.

1. Renormalization group equations can be deduced from the observation that propagators suffer simple scaling as both UV and IR cutoffs and external momenta of n-vertex are scaled up by a power of two. Therefore the effect of the scaling of external can be described as the effect caused by the 2-adic scaling of UV and IR cutoffs.
2. Coupling constant evolution can be seen to emerge in two manners. The variation of IR and UV resolution scales induces coupling constant evolution. If UV cutoff is fixed to  $CP_2$  length scale coupling constant evolution can be assigned to the IR cutoff having interpretation as time scale assignable to zero energy state: .1 seconds in case of electron's p-adic length scale which also happens to define a fundamental biorhythm. Coupling constant evolution emerges also from the dependence of the propagators and vertices on the masses of the virtual particles and in the chapter about calculation of the gauge boson propagator one finds explicit formulas for the propagator. For massless fermions all bare bosonic propagators are identical apart from overall scaling factors. In the case of vertex corrections there is dependence on Lorentz invariants defined by the external momenta and similar universality holds true for bare vertices. The coupling constants estimated in the previous calculations correspond to the IR  $p^2 = 0$  limit for the virtual massless particles.
3. There are two views about coupling constant evolution. The evolution induced by the dependence of the propagator on the mass or mass scale of the virtual gauge boson and the evolution induced by the dependence on the IR cutoff for loop momenta. How these views can be equivalent? The calculation of the propagator as function of mass of virtual gauge boson carried out in the chapter devoted to the calculation of the gauge boson propagator answers this question. The integral defining propagator has a pole at loop momentum representing same or nearly same p-adic length scale as the scale  $k_0$  assignable to  $p$ . If IR cutoff is smaller than the scale of  $p$ , the pole induces a large imaginary part to the inverse of the propagator and thus breaking of unitarity at loop momenta with mass scale below that of  $p$ . Also the sign of the normalization factor of the propagator changes sign due to the large contributions from the scales  $k$  near  $k_0$  so that the gauge coupling strength becomes negative in length scales longer than  $k_0$ . For instance, for the proposed parameterization of the hyperbolic cutoff fine structure constant for loop momenta above electron length scale  $k_0 = 127$  would have magnitude roughly two orders smaller than its value at the limit  $p^2 = 0$  so that  $p^2 = 0$  limit would have nothing to do with the behavior predicted by QFTs. The effect is somewhat analogous to what happens in confinement length scale for  $\alpha_s$ . The interpretation is that virtual bosons in p-adic length  $k_0$  can couple only to loop momenta, which correspond to shorter p-adic length scales and thus have  $k \leq k_0$ . The geometric interpretation in accordance with the vision about coupling constant evolution is that the states inside given  $CD$  couple only to loop states living inside smaller  $CD$ s. The absence of IR divergences is an obvious implication.
4. For the second trial the proposed cutoff predicts that self energy corrections are essentially independent of the choice of the IR cutoff under very mild conditions (for  $p_{min} = 2$  already  $p_{max} = 7$  corresponds to asymptotia). Same is true for the vertex corrections. This is not consistent with the physically attractive interpretation of IR cutoff (size of the largest  $CD$  involved) as the length scale defining the coupling constant evolution. For the third trial situation is quite satisfactory and there are good hopes that reasonable consistency with standard model predictions are obtained when bosonic loops are taken into account.

There are many things to worry about. One can start by worrying about the convergence of the perturbation theory.

1. The disappearance of  $\hbar$  from the perturbation expansion in terms of loops means formally  $g = 1$  condition so that all loop corrections are formally of same order of magnitude, and it might well happen that the expansion does not converge. The contribution to the loop correction comes from the region of momentum space near the UV cutoff only. In this region the four-momentum squared associated with the propagator is near its maximal value and bosonic

propagators behave as  $1/p^2$  only near  $p^2 = 0$ . The expansion in powers of  $1/p^2$  gives an expression of form  $X(\mu^2/p^2)p^2$  for the fermionic self energy loop and the bare propagator is multiplied by a factor  $X_2^{-1}(\mu^2/p^2)$ . In lowest order the loop integral behaves as  $\mu^6/p^4$  at this limit so that propagators would behave as  $p^4/\mu^6$  near UV cutoff.

2. The same effect would tend to reduce the values of the bosonic vertices identified as fermionic loops with  $n$  external gauge bosons. In this case one obtains bare vertex containing in general by a tensor formed from the incoming momenta  $p_i^\mu$  multiplied by a function  $X_n(\mu^2/p_i \cdot p_j)$ , and the powers from propagators emerging from  $n$ -vertex tend to compensate the powers of  $p$  from the fermionic propagators and the convergence of the perturbation theory depends essentially on the limiting values of the factors  $X_n$ . For instance, for bosonic  $n$ -vertex one obtains the scaling factor

$$\frac{X_n(\mu^2/(p_i \cdot p_j))}{\prod_{i=1}^n X_2^{-1}(\mu^2/p_i^2)} .$$

The convergence of the perturbation series is dictated by the behavior of these ratios at the limit  $p_i^2 \rightarrow \mu^2$ . These ratios should become smaller than unity in UV. The numerical constants in question would effectively replace gauge coupling strengths as expansion parameters for the loop corrections in accordance with universality of quantum criticality. For Option b) The main contribution to the coupling constant evolution would come from deep UV near the UV cutoff and would be also more or less independent of UV cutoff as long as it is much higher than incoming momentum scales.

There are also other reasons to worry. Are there hopes that the evolution of coupling constants as functions of incoming momenta is physically acceptable?

1. The most plausible manner to obtain a realistic coupling constant evolution relies on the proper choice of the cutoff for the hyperbolic angle. As found, for the third trial there are good hopes about realistic coupling constant evolution. This option gives good hopes for realistic coupling constant evolution in the range of momenta appearing in particle physics experiments.
2. It remains an open problem whether the quantitative form of this cutoff is deducible in the framework provided by QFT limit or whether it must be accepted as prediction of quantum TGD proper. A realistic coupling constant evolution requires that a very large number of p-adic length scales contributes to the loop integrals. This is typical for quantum criticality. As found, the cutoff in the hyperbolic angle codes for the presence of a large number of scales. Therefore the hyperbolic cutoff should be deducible from quantum criticality. Here also number theoretic Universality might provide strong constraints. One might also hope that the proposed cutoff represents maximal quantum criticality allowed by other constraints. The higher the quantum criticality as measured by the size of hyperbolic cutoff is, the weaker are the coupling strengths estimated from the scale factors of bosonic propagators so that a kind of compromise might be involved. For too large quantum fluctuations interactions get too weak and for too low a criticality they become too strong. The boundary between chaos and order would be in question.

One can also worry about whether the lowest order estimates for the coupling constants interpreted as their bare values are realistic. From the identification of gauge couplings in terms of 2-2 scattering of fermions one can conclude that the experimentally measured coupling strength involves sum over all radiative corrections so that their values can change considerably if the UV end indeed contributes significantly to the vertex corrections.

### 10.2.3 Could quantum criticality fix hyperbolic cutoff uniquely?

Quantum criticality fixes the value of Kähler coupling strength and therefore the p-adic length scale evolution of all gauge couplings. This inspires the question whether one could find a formulation of quantum criticality allowing to deduce the precise form of the hyperbolic cutoff and the dependence of bare gauge boson couplings on the mass of the virtual boson. A concrete formulation for the quantum criticality could be analogous to that for the preferred extremals of Kähler action. Criticality would

state that the matrix defining the second variation of the effective YM action becomes degenerate in some sense.

Several un-successful guesses about what this could mean at the level of propagator were made. The evolution of ideas is described in a separate section. The final proposal was that at quantum criticality all bosonic vertices defined by fermionic loop vanish when the incoming bosons are on mass shell (massless). The condition indeed realizes quantum criticality in the following sense. The vanishing of vertices is very much analogous to the vanishing of higher functional derivatives of the action with respect to gauge fields at criticality (or derivatives of the potential function in Thom's catastrophe theory). The conditions also emerge as consistency conditions: if the vanishing does not occur for on mass shell bosons, one obtains T-matrix expressible in terms of analytic continuation of  $TT^\dagger$  and one does not have vertex identified as something irreducible anymore. Also the fact that only BFF vertex is fundamental vertex if bosonic emergence is accepted, conforms with the conditions. The vanishing of on mass shell N-vertices gives an infinite number of conditions on the hyperbolic cutoff as a function of the integer  $k$  labeling p-adic length scale at the limit when bosons are massless and IR cutoff for the loop mass scale is taken to zero. It is not yet clear whether dynamical symmetries, in particular super-conformal symmetries, are involved with the realization of the vanishing conditions or whether hyperbolic cutoff is all that is needed.

### 10.3 Calculation of the bosonic propagator

The precise form of the bosonic propagator is interesting for obvious reasons. Also this calculation demonstrates the delicacies involved with the loop integration in Minkowski signature. In particular, the behavior of bosonic propagators at large momentum limit is decisive as far as convergence of perturbation theory is considered. Bosonic N-vertex involves  $N$  propagator lines and if single loop integral involves N vertices is proportional to a numerical factor  $a(N, p_i)$  the over all factor associated with bosonic N-vertex from which N internal lines emerge is proportional to  $a(N, \{p_i\})/a(2, p_i)^N$ . The behavior of this factor at the limit when the momenta  $p_i$  approach UV cutoff momentum determines the dominant contribution to the Feynman diagram in the case of loops and if  $a(2, p)$  is sufficiently large at this limit, there are good hopes for convergence. The following calculation of the bosonic propagator at UV limit gives good hopes in this respect.

#### 10.3.1 The basic integrals

The fermionic loop is given by

$$\begin{aligned} X &= -\frac{1}{S} \int d^2k \frac{1}{k^2(p+k)^2} Tr(\gamma^\mu i k^\rho \gamma_\rho \gamma^\nu i(p+k)^\sigma \gamma_\sigma) \\ S &= 2 . \end{aligned} \tag{10.3.1}$$

$S$  is the symmetry factor and  $-1$  is the factor associated with fermionic loop. Using

$$Tr(\gamma^\mu \gamma^\nu \gamma^\rho \gamma^\sigma) = 4(g^{\mu\nu} g^{\rho\sigma} - g^{\mu\rho} g^{\nu\sigma} + g^{\mu\sigma} g^{\nu\rho}) \tag{10.3.2}$$

the traces give

$$X = 2 \int d^4k \frac{1}{k^2(p+k)^2} \times (-p^\mu k^\nu - p^\nu k^\mu - 2k^\mu k^\nu + (k^2 + p \cdot k)g^{\mu\nu}) . \tag{10.3.3}$$

The contraction with the tensor  $P^{\mu\nu}/3$ , where

$$P^{\mu\nu} = g^{\mu\nu} - \frac{p^\mu p^\nu}{p^2} \tag{10.3.4}$$

acts as a projector dropping out polarizations in the direction of momentum, should give the integral as  $XP^{\mu\nu}$  assuming that the gauge invariance of Dirac action is not broken. The projection gives the expression

$$X = 2 \int d^4k \frac{1}{k^2(p+k)^2} \times (3p \cdot k + \frac{(p \cdot k)^2}{p^2} + k^2) \times P^{\mu\nu} . \quad (10.3.5)$$

The calculation of the integral reduces to that for the following three integrals

$$I = 6 \int d^4k \frac{p \cdot k}{k^2(p+k)^2} , \quad J = 2 \int d^4k \frac{1}{(p+k)^2} , \quad K = \frac{2}{p^2} \int d^4k \frac{(p \cdot k)^2}{k^2(p+k)^2} \quad (10.3.6)$$

using the cutoff prescription motivated by the notion of measurement resolution. It is assumed that the momentum  $p$  is time-like. It is not clear whether straightforward analytic continuation allows to deduce the propagator in space-like region.

The integrals over  $k$  can be decomposed to sums of two pieces corresponding to time-like and space-like  $k$ .

$$I = I_t + I_s , \quad J = J_t + J_s , \quad K = K_t + K_s . \quad (10.3.7)$$

In the rest system of the virtual boson the denominator reads in the two cases as

$$\begin{aligned} (p+k)^2 &= p^2 + k^2 + 2pk \times \cosh(\eta) \quad (\text{time-like case}) , \\ (p+k)^2 &= p^2 - |k^2| + 2p|k| \times \sinh(\eta) \quad (\text{space-like case}) . \end{aligned} \quad (10.3.8)$$

From hitherto  $|k^2| \equiv k^2$  will be used to simplify the notation. The space-like case differs from time-like one by  $\cosh(\eta) \rightarrow \sinh(\eta)$  replacements and by the fact that the denominator can vanish so that loop can have an imaginary "dispersive" contribution from the propagator pole which could reduce the normalization factor of the propagator.

Whatever the detailed definitions of the loop integral is, it must satisfy the basic constraint that the integral at the  $p^2 = 0$  limit behaves as  $p^2$  and also its first derivatives with respect to the momentum components vanish: or more generally, the integral is even function of  $p$ .

### 10.3.2 How to avoid generation of mass term?

$p^2 = 0$  limit of the fermionic loop can be deduced by putting  $p^\mu = 0$  in the integrals  $I$  and  $J$ . This gives

$$\begin{aligned} I_s &= 0 , & I_t &= 0 , \\ J_s &= -4\pi \int kdk \int 2\cosh^2(\eta)d\eta , & J_t &= 8\pi \int kdk \int 2\sinh^2(\eta)d\eta , \\ K_s &= 4\pi \int kdk \int 2\cosh^2(\eta)\sinh^2(\eta)d\eta & K_t &= 8\pi \int kdk \int 2\sinh^2(\eta)\cosh^2(\eta)d\eta . \end{aligned} \quad (10.3.9)$$

. Note that the two signs of  $k_0$  in the time-like case give additional factor two. A mass term is generated unless these integrals sum up to zero. The vanishing is achieved if one chooses the hyperbolic cutoffs in time-like and space-like regions to guarantee this. The condition is

$$(J_s + K_s)(\eta_{max,s}) = -(I_t + K_t)(\eta_{max,t}) . \quad (10.3.10)$$

From

$$\begin{aligned} I_s &= 0 , & I_t &= 0 , \\ J_s &= -8\pi \int kdk \int \cosh^2(\eta)d\eta , & J_t &= 16\pi \int kdk \int \sinh^2(\eta)d\eta , \\ K_s &= 8\pi \int kdk \int \cosh^2(\eta)\sinh^2(\eta)d\eta , & K_t &= 16\pi \int kdk \int \sinh^2(\eta)\cosh^2(\eta)d\eta , \end{aligned} \quad (10.3.11)$$

and using

$$\begin{aligned} \int \cosh^2(\eta) d\eta &= \frac{1}{4} \sinh(2\eta) + \frac{\eta}{2} , & \int \sinh^2(\eta) d\eta &= \frac{1}{4} \sinh(4\eta) - \frac{\eta}{2} , \\ \int \sinh^2(\eta) \cosh^2(\eta) d\eta &= \frac{1}{32} \sinh(4\eta) - \frac{1}{8} \eta \end{aligned} \quad (10.3.12)$$

one obtains

$$\begin{aligned} (J_s + K_s)(\eta_{max,s}) &\propto 4 \int_0^{\eta_{max,s}} d\eta \times [-\cosh^2(\eta) + \cosh^2(\eta) \sinh^2(\eta)] \\ &= -\sinh(2\eta_{max,s}) + \frac{1}{8} \sinh(4\eta_{max,s}) - \frac{5}{2} \eta_{max,s} , \\ (J_t + K_t)(\eta_{max,s}) &\propto 4 \int_0^{\eta_{max,s}} d\eta (2\sinh^2(\eta) + 2\cosh^2(\eta) \sinh^2(\eta)) \\ &= 2\sinh(2\eta_{max,t}) + \frac{1}{4} \sinh(4\eta_{max,t}) - 5\eta_{max,t} . \end{aligned} \quad (10.3.13)$$

This gives the condition

$$\begin{aligned} -\sinh(2\eta_{max,s}) + \frac{1}{8} \sinh(4\eta_{max,s}) - \frac{5}{2} \eta_{max,s} \\ = -2\sinh(2\eta_{max,t}) - \frac{1}{4} \sinh(4\eta_{max,t}) + 5\eta_{max,t} . \end{aligned} \quad (10.3.14)$$

The conditions should make sense for arbitrary small values of  $\eta_{max,i}$ . The Taylor expansion to third order gives

$$\eta_{max,s} = \frac{4}{3} \eta_{max,t} \quad (10.3.15)$$

so that this indeed the case. The hyperbolic cutoff for space-like momenta would be considerably tighter than for time-like momenta so that in long length scales time-contributions to the loop integral expected to dominate.

As always, one can criticize.

1. The relationship between time-like and space-like hyperbolic cutoffs is number theoretically cumbersome.
2. In super-symmetric gauge theories [?] loops do not generate mass corrections because super-symmetry implies the vanishing of leading mass corrections. In TGD standard form of SUSY does not seem to be realized but the generalization of this symmetry to super-conformal symmetry might imply the same and even something much more general. This would allow the time-like and space-like hyperbolic cutoffs to be identical and one could avoid the number theoretically cumbersome relationship between the two cutoffs. In fact, in accordance with quantum criticality all loop corrections could vanish for N-point functions with massless external particles with physical polarizations. This would be consistent with the vanishing of the on mass shell inverse propagator. This line of thought will be developed in the last section of the chapter.

### 10.3.3 Explicit form of the integrals

In the space-like case one has

$$\begin{aligned}
I_1 &= I_{pole,1} + I_{P,1} , \\
I_{pole,1} &= -6i\pi p \int d^4k \times \frac{p \cdot k}{k^2} \delta((p+k)^2) , \quad I_{P,1} = 6P \int d^4k \times \frac{p \cdot k}{k^2(p+k)^2} , \\
J_1 &= J_{pole,1} + J_{P,1} , \\
J_{pole,1} &= -2i\pi \int d^4k \times \delta((p+k)^2) , \quad J_{P,1} = 2P \int d^4k \frac{1}{(p+k)^2} , \\
K_1 &= K_{pole,1} + K_{P,1} , \\
K_{pole,1} &= -2i\pi \int d^4k \frac{(p \cdot k)^2}{p^2} \times \delta((p+k)^2) , \quad K_{P,1} = 2P \int d^4k \frac{(p \cdot k)^2}{p^2} \frac{1}{(p+k)^2} .
\end{aligned} \tag{10.3.16}$$

$P$  denotes principal value integral.

### Principal value contributions

In the calculation of principal value contributions one must notice that both signs of  $k_0$  are possible in time-like case. One can also restrict the integration range over  $\eta$  to positive value of  $\eta$  by appropriate arrangement of contribution from different signs of  $\eta$ . In space-like case this gives to terms corresponding to different signs  $\epsilon_s$  of  $\sinh(\eta(2))$  and in time-like case just a factor of 2. Different signs of energy give to terms corresponding to different signs  $\epsilon_t$  of  $p \cdot k = \pm pk \cosh(\eta)$ .

The principal value contributions to space-like integrals can be written as

$$\begin{aligned}
I_P^s &= 4\pi \int_0^{\eta_{max,s}} d\eta \times \cosh^2(\eta) \times i_s , \quad i_s = -3p \sum_{\epsilon_s} \epsilon_s \sinh(\eta) \int dk \frac{k^2}{p^2 - k^2 + 2\epsilon_s pk \sinh(\eta)} , \\
J_{P,1}^s &= 4\pi \int_0^{\eta_{max,s}} d\eta \times \cosh^2(\eta) \times j_s , \quad j_s = 2 \sum_{\epsilon_s} \int dk \frac{k^3}{p^2 - k^2 + 2\epsilon_s pk \sinh(\eta)} , \\
K_{P,1}^s &= 4\pi \int_0^{\eta_{max,s}} d\eta \times \cosh^2(\eta) \times k_s , \quad k_s = 2 \sum_{\epsilon_s} \int dk \frac{k^3 \sinh^2(\eta)}{p^2 - k^2 + 2\epsilon_s pk \sinh(\eta)} .
\end{aligned} \tag{10.3.17}$$

One must be very careful with the sign factors. In the time-like case one has only principal value contributions and one obtains very similar expressions

$$\begin{aligned}
I_P^t &= 4\pi \int_0^{\eta_{max,t}} d\eta \times \sinh^2(\eta) \times i_t , \quad i_t = 6p \cosh(\eta) \sum_{\epsilon_t} \epsilon_t \int dk \frac{k^2}{p^2 + k^2 + 2\epsilon_t pk \cosh(\eta)} , \\
J_P^t &= 4\pi \int_0^{\eta_{max,t}} d\eta \times \sinh^2(\eta) \times j_t , \quad j_t = 2 \sum_{\epsilon_t} \int dk \frac{k^3}{p^2 + k^2 + 2\epsilon_t pk \cosh(\eta)} , \\
K_{P,1}^t &= 4\pi \int_0^{\eta_{max,t}} d\eta \times \cosh^2(\eta) \times k_t , \quad k_t = 2 \sum_{\epsilon_t} \int dk \frac{k^3 \cosh^2(\eta)}{p^2 - k^2 + 2\epsilon_t pk \sinh(\eta)} .
\end{aligned} \tag{10.3.18}$$

An additional factor two results from the fact that  $\eta \geq 0$  is assumed. In time-like case there is contribution from both signs of  $k^0$  so that one obtains also an integral in which  $k$  is replaced with its negative in the denominator.

### Pole contributions

The poles of the integrand are given by

$$\begin{aligned}
k_{\epsilon_1, \epsilon_2}^s &= \epsilon_1 p \times \exp(\epsilon_2 \eta) \quad (\text{space-like case}) , \\
k_{\epsilon_1, \epsilon_2}^t &= \epsilon_2 p \times \exp(\epsilon_1 \eta) \quad (\text{time-like case}) , \quad \epsilon_i = \pm 1 .
\end{aligned} \tag{10.3.19}$$

Note that  $\epsilon_1$  refers to the roots associated with the same denominator and  $\epsilon_2$  to different denominators. For space-like (time-like) case only  $\epsilon_1 = 1$  ( $\epsilon_2 = 1$ ) gives a pole in the physical region. The differences of the roots will be needed in the calculations and are given by

$$\begin{aligned} k_{+, \epsilon_2}^s - k_{-, \epsilon_2}^s &= 2p \exp(\epsilon_2 \eta) \quad (\text{space-like case}) , \\ k_{+, \epsilon_2}^t - k_{-, \epsilon_2}^t &= 2p \epsilon_2 \sinh(\eta) \quad (\text{time-like case}) . \end{aligned} \quad (10.3.20)$$

The pole contribution is present for both space-like and time-like cases. The delta function  $\delta((p+k)^2)$  can be written in terms of  $k$  and  $\eta$ . In the time-like case as

$$\begin{aligned} \delta((p+k)^2) d^4 k &= \delta(p+k)^2 \frac{\partial(k, \eta)}{\partial((p+k)^2, \eta)} d((p+k)^2) \sinh^2(\eta) d\eta d\Omega , \\ \frac{\partial(k, \eta)}{\partial((p+k)^2, \eta)} &= \frac{1}{p} \times \frac{1}{2 \cosh(\eta) + \epsilon_1 \sinh(\eta)} . \end{aligned} \quad (10.3.21)$$

In the space-like case one has

$$\begin{aligned} \delta((p+k)^2) d^4 k &= \delta(p+k)^2 \frac{\partial(k, \eta)}{\partial((p+k)^2, \eta)} d((p+k)^2) \cosh^2(\eta) d\eta d\Omega , \\ \frac{\partial(k, \eta)}{\partial((p+k)^2, \eta)} &= \frac{1}{p} \times \frac{1}{-\cosh(\eta)} . \end{aligned} \quad (10.3.22)$$

The integration over  $\Omega$  gives a factor of  $4\pi$ . By combining integrals over  $\eta$  to integral over positive values of  $\eta$  one finds that  $I_{pole}^s$  vanishes since  $\epsilon_2 \rightarrow -\epsilon_2$  is equivalent with  $\eta \rightarrow -\eta$ . Similar vanishing takes place for  $I_{pole}^t$  since different signs of energy give different sign for  $p \cdot k$  factor.  $\eta \rightarrow -\eta$  corresponds to  $\epsilon_1 \rightarrow -\epsilon_1$  for  $I_{pole}^t$  and to  $\epsilon_1 \rightarrow -\epsilon_1$  for  $J_{pole}^s$  and in both cases one obtains factor 2. Hence the contribution from the poles  $k_{\epsilon_1, \epsilon_2}$  can be written as

$$\begin{aligned} I_{pole}^s &= 0 , \quad I_{pole}^t = 0 , \\ J_{pole, \epsilon_2}^s + K_{pole, \epsilon_2}^s &= -i 16 \pi^2 p^2 \int_0^{\eta_{max, s}} d\eta \times (1 - \sinh^2(\eta)) \times \cosh^2(\eta) \frac{\exp(3\epsilon_2 \eta)}{-\cosh(\eta)} , \\ J_{pole, \epsilon_1}^t + K_{pole, \epsilon_1}^t &= -i 32 \pi^2 p^2 \int_0^{\eta_{max, t}} d\eta \times (1 + \cosh^2(\eta)) \times \sinh^2(\eta) \frac{\exp(3\epsilon_1 \eta)}{2 \cosh(\eta) + \epsilon_1 \sinh(\eta)} , \end{aligned} \quad (10.3.23)$$

Pole contributions in the time-like case involve additional factor 2 due to the two signs of  $k^0$ . One must integrate separately the pole contributions corresponding to different signs of  $\epsilon_i$ . The reason is that the integration limits for  $\eta$  are in general different because the upper or lower limit for  $\eta$  integration can be reduced or increased since  $k_{\pm}$  must belong to the half octave in question. The determination of the bounds of hyperbolic integral requires a special care. This point is discussed in the chapter devoted to the calculation of the gauge boson propagator.

Note that the poles give a small imaginary contribution to the kinetic term corresponding to free theory and imply a breaking of unitarity. The masses of the poles are in good approximation equal to  $k^2 = p^2$  for small values of  $p$ .

### 10.3.4 k-integration for the principal value parts of the integrals

The integrals over  $k$  reduce to integrals of rational functions using the general expression for poles given in Eq. 10.3.19. Each octave in momentum space gives its own contribution.

The integrals to be calculated are

$$\begin{aligned}
i_s &= -3p \sinh(\eta) \sum_{\epsilon_s} \epsilon_s \int dk \frac{k^2}{p^2 - k^2 + 2\epsilon_s p k \sinh(\eta)} , \\
i_t &= 6p \cosh(\eta) \sum_{\epsilon_t = \pm 1} \epsilon_t \int dk \frac{k^2}{p^2 + k^2 + 2\epsilon_t p k \cosh(\eta)} , \\
j_s + k_s &= (1 - \sinh^2(\eta)) \sum_{\epsilon_s} \int dk \frac{k^3}{p^2 - k^2 + 2\epsilon_s p k \sinh(\eta)} , \\
j_t + k_t &= 2(1 + \cosh^2(\eta)) \sum_{\epsilon_t} \int dk \frac{k^3}{p^2 + k^2 + 2\epsilon_t p k \cosh(\eta)} .
\end{aligned} \tag{10.3.24}$$

The  $k$ -integral is over the half-octave  $[2^{(-k-1)/2}, 2^{-k/2}]m(CP_2)$ . The poles can be written as  $k_{\epsilon_s}^s = \epsilon p \times \exp(\epsilon \eta)$  in space-like case and as  $k_{\epsilon_t}^t = -\epsilon_t p \times \exp(\epsilon_t \eta)$  in time-like case. One can express the denominators appearing in the integrands in terms of them as

$$\begin{aligned}
\frac{1}{p^2 - k^2 + 2\epsilon_s p k \sinh(\eta)} &= \frac{1}{k_{+\epsilon_s}^s - k_{-\epsilon_s}^s} \sum_{\epsilon} \frac{\epsilon}{k - p \epsilon \exp(\epsilon \eta)} \\
&= \frac{1}{2p \exp(\epsilon_s \eta)} \times \left[ \frac{1}{k - p \times \exp(\epsilon_s \eta)} - \frac{1}{k + p \times \exp(-\epsilon_s \eta)} \right] , \\
\frac{1}{p^2 + k^2 + 2\epsilon_t p k \cosh(\eta)} &= \frac{1}{k_{+\epsilon_t}^t - k_{-\epsilon_t}^s} \sum_{\epsilon} \frac{\epsilon}{k - p \epsilon \exp(\epsilon \eta)} \\
&= -\frac{1}{p \sinh(\eta)} \times \left[ \frac{1}{k - p \epsilon_t \exp(\epsilon_t \eta)} - \frac{1}{k - p \times \epsilon_t \exp(-\epsilon_t \eta)} \right] .
\end{aligned} \tag{10.3.25}$$

This gives

$$\begin{aligned}
i_s &= -\frac{3 \sinh(\eta)}{2} \int dk \times k^2 \left[ \exp(-\eta) \left( \frac{1}{k - p \times \exp(\eta)} - \frac{1}{k + p \times \exp(\eta)} \right) \right. \\
&\quad \left. - \exp(\eta) \left( \frac{1}{k - p \times \exp(-\eta)} - \frac{1}{k + p \times \exp(-\eta)} \right) \right] , \\
i_t &= -6 \frac{\cosh(\eta)}{\sinh(\eta)} \int dk \times k^2 \left[ \frac{1}{k - p \times \exp(\eta)} - \frac{1}{k - p \times \exp(-\eta)} \right. \\
&\quad \left. - \frac{1}{k + p \times \exp(-\eta)} + \frac{1}{k + p \times \exp(\eta)} \right] , \\
j_s + k_s &= \frac{(1 - \sinh^2(\eta))}{2p} \int dk \times k^3 \left[ \exp(-\eta) \left( \frac{1}{k - p \times \exp(\eta)} - \frac{1}{k + p \times \exp(\eta)} \right) \right. \\
&\quad \left. + \exp(\eta) \left( \frac{1}{k - p \times \exp(-\eta)} - \frac{1}{k + p \times \exp(-\eta)} \right) \right] , \\
j_t + k_t &= -\frac{2(1 + \cosh^2(\eta))}{p \sinh(\eta)} \int dk \times k^3 \left[ \frac{1}{k - p \times \exp(\eta)} + \frac{1}{k - p \times \exp(-\eta)} \right. \\
&\quad \left. + \frac{1}{k + p \times \exp(-\eta)} - \frac{1}{k + p \times \exp(\eta)} \right] ,
\end{aligned}$$

One must calculate integrals of form  $i_n = \int_a^b dk \frac{k^n}{k-K}$ . Taking  $k_1 = k - K$  as the integration variable, using binomial expansions, the transformation of integration limits  $[a, b]$  to  $[a - K, b - K]$ , and the expressions for the integration limits given by  $[a, b] = [2^{-(k+1)/2}, 2^{-k/2}] \times m(CP_2) \equiv [2^{-1/2}, 1]m_k$  (the  $k$  in  $p \simeq 2^k$  should not be confused with the integration variable) one obtains



$$\begin{aligned}
 i_n &= \int dk \frac{k^n}{k-K} = \sum_{m=1}^n \frac{b(n,m)}{m} \times K^{n-m} \left[ \sum_{r=0}^{m-1} (-1)^r \times b(m,r) \times (b^{m-r} - a^{m-r}) K^r \right] \\
 &+ K^n \log\left(\left|\frac{b-K}{a-K}\right|\right), \quad b(n,m) = \frac{n!}{(n-m)!m!}, \\
 (a,b) &= (2^{-1/2}, 1)m_k, \quad K = \epsilon_1 p \times \exp(\epsilon_2 \eta) \quad \text{or} \quad K = \epsilon_1 p \times \exp(\epsilon_2 \eta).
 \end{aligned}
 \tag{10.3.26}$$

Polynomial terms give contributions which come as powers  $K^m$ ,  $m \leq n - 1$  and would give to kinetic term a contribution which is power  $p^k$ ,  $k = 0, 1$  for  $n = 2$  and  $k = -1, 0, 1$  for  $n = 3$ . What is known about  $p^2 = 0$  limit implies that these terms must sum up to zero, for  $i_1$  and  $i_t$ . This indeed happens as explicit check shows. For  $j_s$  and  $j_t$  one must obtain a constant contribution independent of  $p$  and giving rise to mass term in the propagator. This would correspond to  $p^k$ ,  $k = 1$ . The terms must be same apart from sign and cancel each other only if the hyperbolic cutoffs are related in the proposed manner.

The logarithmic terms associated with the poles  $K = k_{\pm}^{s/t}$  can be combined to single logarithm. Getting the sign factors correctly takes some time and one must be careful with the expressions for the roots and their differences  $k_{\pm, \epsilon_2}$  which are reproduced for here for the reader's convenience.

$$\begin{aligned}
 k_{\pm, \epsilon_2}^s &= \pm p \times \exp(\epsilon_2 \eta) \quad (\text{space-like case}), \\
 k_{\pm, \epsilon_2}^t &= \epsilon_2 p \times \exp(\pm \eta) \quad (\text{time-like case}), \\
 k_+^s - k_-^s &= 2p \exp(\epsilon_2 \eta), \quad (\text{space-like case}), \\
 k_{+, \epsilon_2}^t - k_{-, \epsilon_2}^t &= 2p \epsilon_2 \sinh(\eta), \quad (\text{time-like case}).
 \end{aligned}
 \tag{10.3.27}$$

The sum over the logarithms combines to form a logarithmic term which is of following form in various cases.

$$\begin{aligned}
 i_s &= p^2 \frac{3 \sinh(\eta)}{2} \times \left[ \exp(\eta) \log(F_1(\frac{p}{m_k} \exp(\eta))) \right. \\
 &\quad \left. - \exp(-\eta) \log(F_1(\frac{p}{m_k} \exp(-\eta))) \right], \\
 i_t &= -6p^2 \frac{\cosh(\eta)}{\sinh(\eta)} \times \left[ \exp(2\eta) \log(F_2(\frac{p}{m_k} \exp(\eta))) \right. \\
 &\quad \left. - \exp(-2\eta) \log(F_2(\frac{p}{m_k} \exp(-\eta))) \right], \\
 j_s + k_s &= \frac{p^2}{2} \times (1 - \sinh^2(\eta)) \left[ \exp(2\eta) \log(F_2(\frac{p}{m_k} \exp(\eta))) \right. \\
 &\quad \left. + \exp(-2\eta) \log(F_2(\frac{p}{m_k} \exp(-\eta))) \right], \\
 j_t + k_t &= -p^2 \frac{2(1 + \cosh^2(\eta))}{\sinh(\eta)} \times \left[ \exp(3\eta) \log(F_1(\frac{p}{m_k} \exp(\eta))) \right. \\
 &\quad \left. + \exp(-3\eta) \log(F_1(\frac{p}{m_k} \exp(-\eta))) \right],
 \end{aligned}
 \tag{10.3.28}$$

where the functions  $F_i(x)$  are given by

$$\begin{aligned}
 F_1(x) &= \left| \frac{(2+x)(\sqrt{2}-x)}{(2-x)(\sqrt{2}+x)} \right|, \\
 F_2(x) &= \left| \frac{(2+x)(2-x)}{(\sqrt{2}+x)(\sqrt{2}-x)} \right|
 \end{aligned}
 \tag{10.3.29}$$

For small values of  $x$  one has  $F_1(x) \simeq 1$  and  $F_2(x) \simeq 2$  so that only  $F_1(x)$  contributes significantly to the propagator for  $p \exp(\pm \eta) \ll m_k$ . For large values of  $x$  one has  $F_i(x) \simeq 1$  so that neither of them contributes for  $p \gg m_k$ . For  $p = 2m_k \exp(\pm \eta)$   $F_i$  has infinite value so that one obtains a logarithmic singularity. Since the integration range over  $\eta$  is shortens with exponential rate as function of  $k$ , the logarithmic contribution does not have significant effects. It however means that p-adic length scale

hierarchy is visible as a small effect. If the momentum squared does not correspond to p-adic mass scale  $\log(F_1) \simeq 0$  and  $\log(F_2) \simeq \log(2)/2$  holds true and the kinetic term is in excellent approximation proportional to  $p^2$ . Since  $F_i$  are even functions of  $p$ , they are actually functions of  $p^2$  rather than  $p$  as one might indeed expect on basis of analyticity requirement.

The expressions for the non-vanishing functions at this limit read as

$$\begin{aligned} i_t &= -12\log(2)p^2\cosh^2(\eta) , \\ j_s &= \frac{\log(2)}{2}(2\cosh^2(\eta) - 1)(1 - \sinh^2(\eta)) . \end{aligned} \quad (10.3.30)$$

At the  $p^2 = 0$  limit-that is in p-adic mass scales much larger than  $p$ - one has in the next approximation

$$\begin{aligned} F_1(x) &\simeq (1 - \sqrt{2}) \times x + O(x^3) = (1 - \sqrt{2}) \times \frac{p}{m_k} u^{\pm 1} , \\ F_2(x) &\simeq \frac{x^2}{4} + O(x^3) = \frac{1}{4} \left(\frac{p}{m_k}\right)^2 u^{\pm 2} , \end{aligned} \quad (10.3.31)$$

This gives

$$\begin{aligned} i_s &\simeq p^2 \times 2(1 - \sqrt{2}) \times \frac{p}{m_k} \frac{3\sinh(\eta)}{2} \times \sinh(2\eta) , \\ i_t &\simeq -6p^2 \frac{\cosh(\eta)}{\sinh(\eta)} \times \left[ 2\log(2)\sinh(2\eta) - \frac{1}{2} \left(\frac{p}{m_k}\right)^2 \sinh(4\eta) \right] , \\ j_s + k_s &\simeq \frac{p^2}{2} \times (1 - \sinh^2(\eta)) \left[ 2\log(2)\cosh(2\eta) + \frac{1}{2} \left(\frac{p}{m_k}\right)^2 \cosh(4\eta) \right] , \\ j_t + k_t &\simeq -p^2 \times 2(1 - \sqrt{2}) \times \frac{p}{m_k} \frac{2(1+\cosh^2(\eta))}{\sinh(\eta)} \times \cosh(4\eta) , \end{aligned} \quad (10.3.32)$$

At the IR limit  $p/m_k \gg 1$  one can expand the logarithms with respect to the variable  $1/x$  and the lowest order gives

$$\begin{aligned} F_1(x) &\simeq -\frac{2}{x^2} + O(x^{-3}) = -\left(\frac{p}{m_k}\right)^{-2} u^{\mp 2} , \\ F_2(x) &\simeq 2(2 - \sqrt{2}) \times x^{-1} + O(x^{-3}) = 2(2 - \sqrt{2}) \times \left(\frac{p}{m_k}\right)^{-1} u^{\mp 1} . \end{aligned} \quad (10.3.33)$$

$$(10.3.34)$$

$$\begin{aligned} i_s &\simeq p^2 \times 2\left(\frac{p}{m_k}\right)^{-2} \times \frac{3\sinh(\eta)}{2} \times \sinh(\eta) , \\ i_t &\simeq -6p^2 \frac{\cosh(\eta)}{\sinh(\eta)} \times \left[ 2\log(2)\sinh(2\eta) + 4(2 - \sqrt{2})\left(\frac{p}{m_k}\right)^{-1} \sinh(\eta) \right] , \\ j_s + k_s &\simeq \frac{p^2}{2} \times 2(2 - \sqrt{2}) \times (1 - \sinh^2(\eta)) \left[ 2\log(2)\cosh(2\eta) + 4(2 - \sqrt{2})\left(\frac{p}{m_k}\right)^{-1} \cosh(\eta) \right] , \\ j_t + k_t &\simeq -p^2 \times 2\left(\frac{p}{m_k}\right)^{-2} \times \frac{2(1+\cosh^2(\eta))}{\sinh(\eta)} \times \cosh(2\eta) . \end{aligned} \quad (10.3.35)$$

One can write  $p/m_k$  as  $p/m_k = 2^{k/2} \times p/m(CP_2)$ . If  $p$  corresponds to the p-adic mass scale  $k_0$  one can write  $p/m_k = x \times 2^{k_0/2} m(CP_2)$  so that one has  $p/m_k = x2^{(k_0-k)/2}$  so that the higher order contributions decrease with an exponential rate as a function of  $|k - k_0|$ .

### 10.3.5 Numerical calculation of the integrals over the hyperbolic angle

The integrals over the hyperbolic angle  $\eta$  can be computed analytically in the case of pole contributions since integrals of rational functions are in question. In the case of principal value contributions situation is different since logarithms are present. Also now approximate analytic approach is convenient since the model for how quantum criticality might dictate the hyperbolic cutoff requires calculation

of the the derivatives of the integrals with respect to momentum  $p$  and analytic approximation to integrals allows to perform this calculation in terms of elementary functions.

Predicting coupling constant evolution and the bare values of couplings constants is something which is not done every day, and it is important to make all calculations public so that the reader can detect possible errors. Therefore I have reported the calculation in all boring detail.

**Overall view about calculation**

The following summary is for a reader willing to carry out the calculations himself.

1. By taking  $u = e^n$  as integration variable, the partial fraction expansion of the rational functions multiplying  $F_i$  in various integrals gives integrals of form  $\int u^n \log(|1 + xu|)$  for both signs of  $n$  and  $x$ . If  $x$  is very small, the best manner to proceed is to expand the logarithm to a Taylor polynomial. If  $x$  is very large one can expand  $\log(u + 1/x)$  into Taylor polynomial. For  $x$  not too far from unity one replace the integration variable with  $v = u + 1/x$  and expand  $u^n = (v - 1/x)^n$  using binomial formula, one obtains for  $n \geq 0$  integrals of form  $\int v^n \log(|v|)$  and partial integration allows to deduce expression for this integrals in terms of elementary functions as

$$\int (v + u_0)^n \log(v) dv = \sum_{k=0}^n b(n, k) u_0^{n-k} v^{k+1} \left( \frac{\log(v)}{k+1} - \frac{1}{(k+1)^2} \right) .$$

2. Also integrals of form  $\int v^{-n} \log(|v|) du$  are encountered. By changing the integration variable to  $v = 1/u$  these integrals can be transformed to  $v^n \log(v - v_0)$  type integrals for  $n \geq 2$ . Therefore only the integral  $\int u^{-1} \log(|u - u_0|) du$  remains.
3. For the integrals of type  $\int \frac{1}{x} \log(|1 - x|) dx$ ,  $x = u/u_0$ , one can use in the region  $u/u_0 < 1$  the expansion of the denominator in geometric series to obtain the integral function as

$$\int \frac{1}{x} \log(|1 - x|) dx = \sum \frac{(-1)^{n+1} x^n}{n^2} \equiv F(x) .$$

It seems that this function does not allow expression in terms of elementary functions.

4. If  $u - u_0$  vanishes in the integration range the situation is more delicate and the integration range must be divided into two parts. In this case one can expand  $u^{-n} = (u_0 + v)^{-n}$  in Taylor series so that one obtains integrals of  $\int v^n \log(|v|) dv$  are obtained. The integral reduces to

$$\int \frac{\log(x - x_0)}{x} dx = \log(|x - x_0|) \log\left(\left|1 - \frac{x}{x_0}\right|\right) - F\left(\frac{x - x_0}{x_0}\right) .$$

The variation range of  $v$  is very restricted since  $u$  varies in the vicinity of  $u = 1$  so that the series converges rapidly. The numerical control of the integration reduces to the control of the degree of the Taylor polynomials. An additional numerical difficulty is posed by the analytic expressions which involve large terms summing up to zero. To guarantee the cancelation also numerically, one can combine the contributions from the logarithms  $\log(|1 \pm x_k 2^{-r} u|)$  appearing in  $\log(F_i)$  to single expression. This also minimizes the possibility of sign errors.

To sum up, the completely standard integral formulas needed in the numerical calculations are

$$\begin{aligned} \int \log(x) x^m dx &= x^{m+1} \left( \frac{\log(x)}{m+1} - \frac{1}{(m+1)^2} \right) , \\ \int \log(x) x^{-m} dx &= -\frac{1}{m-1} \log(x) x^{-m+1} - \frac{1}{(m-1)^2} x^{-m+1} , \quad m \neq 1 , \\ \int \log(x) x^{-1} &= \frac{1}{2} \log(x)^2 . \end{aligned} \tag{10.3.36}$$

Explicit numerical approximations reduce to the cutoff of  $F(x)$  to Taylor polynomial.

Since I possess rather primitive calculational tools (MATLAB in home computer) the need to do the calculations fast enough to perform them within day rather than year forces a rather detailed

analysis of the calculation and also kind of re-synthesis besides the use of analytic formulas. A careful planning of calculations is necessary in order to avoid un-necessary multiple calculations and loops rather than just performing simple discretization of the integration variable disfavored also by the logarithmic singularities of the integrands. The strategy has been simple.

1. Separate the easily calculable contribution corresponding to  $p^2 = 0$  limit for which  $F_2 = \log(2)$  and  $F_1 = 0$  hold true. The remaining contribution should be small for typical values of  $p$ .
2. Calculate the coefficients of Laurent and Taylor polynomials having no dependence on cutoff, momentum, or p-adic integer  $k$  to arrays in the beginning of the calculation as loops and store them as data.
3. Calculate the coefficients depending on momentum parameter  $p$  and p-adic integer  $k$  to arrays in the same manner.
4. Identify the basic integrals depending on the hyperbolic cutoff  $u_{max,t}$  or  $u_{max,s}$ , calculate them, and store them into arrays in the beginning of calculation using loops since there are typically conditions involved with each step of calculation so that loops cannot be avoided.
5. Calculate the basic contributions to propagator normalization factor from  $i_s, i_t, j_s + k_s, j_t + k_t$  using matrix operations and element-wise operations for arrays to avoid loops.
6. Use Taylor polynomials in the case that the analytic expression in terms of elementary functions does not exist or if the exact analytic expression is numerically unstable (say involves sum of large contributions summing up to zero but failing to do this exactly in the numerical approach). For instance, this strategy inspires the calculation and storing into arrays of integrals of  $\int du \times u^n \log(F_i)$  rather than  $\int du \times u^n \log(1 + 2^{-r} x_k u)$  to which the integral decomposes.

### Representation of rational functions appearing in integrands

Since I do not have opportunity to use symbol manipulation packages I include the detailed formulas for various functions involved it is essential to keep documentation as precise as possible so that I include detailed formulas allowing immediate computerization. The inverse of the propagator is apart from the projector  $P^{\mu\nu}$  equal to the sum of the following integrals.

$$\begin{aligned}
 \int d\eta \times \cosh^2(\eta) i_s &= C_1 \int du \times [r_1(u) \times \log(F_1(x_k u)) - u^{-2} r_1(u) \times \log(F_1(x_k u^{-1}))] \quad , \\
 r_1(u) &= (u - u^{-1})(u + u^{-1})^2 = u^3 + u - u^{-1} - u^{-3} \quad , \\
 \int d\eta \times \sinh^2(\eta) i_t &= C_2 \int du \times [r_2(u) \times \log(F_2(x_k u)) - u^{-4} r_2(u) \times \log(F_2(x_k u^{-1}))] \quad , \\
 r_2(u) &= u(u + u^{-1})(u - u^{-1}) = u(u^2 - u^{-2}) \quad , \\
 \int d\eta \times \cosh^2(\eta) (j_s + k_s) &= C_3 \times \int du \times r_3(u) [r_3(u) \log(F_2(x_k u)) + u^{-4} r_3(u) \times \log(F_2(x_k u^{-1}))] \quad , \\
 r_3(u) &= u(4 - (u - u^{-1})^2)(u + u^{-1})^2 = u(-u^4 + 4u^2 + 10 + 4u^{-2} - u^{-4}) \quad , \\
 \int d\eta \times \sinh^2(\eta) (j_t + k_t) &= C_4 \int du \times [r_4(u) \times \log(F_1(x_k u)) + u^{-6} r_4(u) \times \log(F_1(x_k u^{-1}))] \quad , \\
 r_4(u) &= u^2(4 + (u + u^{-1})^2)(u - u^{-1}) = u^2(u^3 + 5u - 5u^{-1} - u^{-3}) \quad , \\
 C_1 &= \frac{3\pi p^2}{2} \quad , \quad C_2 = -6\pi p^2 \quad , \quad C_3 = \frac{\pi p^2}{2} \quad , \quad C_4 = -\pi p^2 \quad .
 \end{aligned}
 \tag{10.3.37}$$

In the integration of the latter terms containing  $\log(F_i(x_k u^{-1}))$  the simplest formulas are obtained by taking  $v = u^{-1}$  as an integration variable since there is high degree of symmetry between  $r$  and  $s$  contributions.  $du = -dv/v^2$  brings in one negative power of  $v$  and  $u^k$  goes to  $v^{-k}$  so that one has  $u^k \rightarrow v^{-k-2}$ . Since integrand apart multiplying  $d\eta$  satisfies  $F(u) = F(v)$  and since the

integration measure  $d\eta = du/u$  equals to  $-dv/v$  the overall result is that the integrand only changes sign:  $F(u)du = -F(v)dv$  and the integration limits  $[1, u_{max}]$  are replaced with  $[1, u_{max}^{-1}]$ . Hence the integrals associated with the latter terms can be reduced to the integrals defined by  $r_i(u)$ . Taking into account the symmetries of the integrand this gives the formulas

$$\begin{aligned} i_s : \quad & I = I(1, u_{max,s}) - I(1, u_{max,s}^{-1}) , \\ i_t : \quad & I = I(1, u_{max,t}) - I(1, u_{max,t}^{-1}) , \\ j_s + k_s : \quad & I = I(1, u_{max,s}) - I(1, u_{max,s}^{-1}) , \\ j_t + k_t : \quad & I = I(1, u_{max,s}) + I(1, u_{max,s}^{-1}) . \end{aligned} \tag{10.3.38}$$

For  $j_t + k_t$  the integrals obviously tend to cancel each other.

The rational functions  $r_i$  multiplying functions  $F_i$  in various cases can be expressed by giving the non-vanishing coefficients in their Laurent expansion

$$r_i(u) = \sum_k r_{i,k}^+ u^k + \sum_k r_{i,k}^- u^{-k}$$

to make the integration procedure systematic.

One obtains for the non-vanishing coefficients following expressions

$$\begin{aligned} r_{1,1}^+ = 1 , \quad r_{1,3}^+ = 1 , \quad r_{1,1}^- = -1 , \quad r_{1,3}^- = -1 , \\ r_{2,3}^+ = 1 , \quad r_{2,1}^- = -1 , \\ r_{3,1}^+ = 10 , \quad r_{3,3}^+ = 4 , \quad r_{3,5}^+ = -1 , \quad r_{3,1}^- = 4 , \quad r_{3,3}^- = -1 , \\ r_{4,1}^+ = -5 , \quad r_{4,3}^+ = 3 , \quad r_{4,5}^+ = 1 , \quad r_{4,1}^- = -1 . \end{aligned} \tag{10.3.39}$$

Only the coefficients  $r_{i,1}^-$  give rise to an integral not expressible in terms of elementary functions.

**Functions  $F_i$**

The functions  $F_i$  and their derivatives are given by

$$\begin{aligned} F_1(x) = \left| \frac{(2+x)(\sqrt{2-x})}{(2-x)(\sqrt{2+x})} \right| , \quad F_2(x) = \left| \frac{(2+x)(2-x)}{(\sqrt{2+x})(\sqrt{2-x})} \right| , \\ \log(F_1)' = \frac{1}{2+x} + \frac{1}{2-x} - \frac{1}{\sqrt{2+x}} - \frac{1}{\sqrt{2-x}} , \quad \log(F_2)' = \frac{1}{2+x} - \frac{1}{2-x} - \frac{1}{\sqrt{2+x}} + \frac{1}{\sqrt{2-x}} , \end{aligned} \tag{10.3.40}$$

It is convenient to extract from the integrals the contribution which corresponds to  $p^2 = 0$  limit given by Eq. 10.3.30. This contribution comes from  $F_2$  alone since  $F_1$  vanishes at this limit.

For systemization purposes it is convenient to introduce the functions  $V(i, \epsilon)(x, u)$  as

$$\begin{aligned} V_{1,\epsilon}(x_k, u) = \log(F_1(x_k u^\epsilon)) = \sum_{\epsilon_1, r} V(1, \epsilon_1, r) \log(|1 + \epsilon_1 2^{-r} x_k u^\epsilon|) , \\ V_{2,\epsilon}(x_k, u) = \log(F_2(x_k u^\epsilon)/2) = \sum_{\epsilon_1, r} V(2, \epsilon_1, r) \log(|1 + \epsilon_1 2^{-r} x_k u^\epsilon|) , \\ V(1, \epsilon_1, 1) = 1 , \quad V(1, \epsilon_1, 1/2) = -1 , \\ V(2, \epsilon_1, 1) = (-1)^{\epsilon_1} , \quad V(2, \epsilon_1, 1/2) = (-1)^{\epsilon_1 - 1} . \end{aligned} \tag{10.3.41}$$

The logarithms  $\log(|2^r + \epsilon_1 x_k u^{\epsilon-1}|)$  can be decomposed as

$$\log(|1 + \epsilon_1 2^{-r} x_k u^{-1}|) = \log(|u + \epsilon_1 2^{-r} x_k|) - \log(|u|) . \tag{10.3.42}$$

The contributions from  $\log(u)$  terms cancel for  $F_i$  and one obtains effectively contribution of form

$$\begin{aligned} \sum_n r_{i,n}^\pm \int u^n \log(|1 + \epsilon_1 2^{-r} x_k u|) du , \\ \sum_n s_{i,n}^\pm \int u^n \log(|u + \epsilon_1 2^{-r} x_k|) , \end{aligned} \tag{10.3.43}$$

Note that when  $x_k$  is small *resp.* large the total contributions are of order  $x_k$  *resp.*  $1/x_k$  and therefore very small.

### Expression of the integrals in terms of the basic integrals

One can express the integrals in terms of following basic integrals:

$$I_n(u_0, u_{max}) = \int_1^{u_{max}} du \times u^n \log(|u + u_0|) \quad , \quad J_n(u_{max}) = \int_1^{u_{max}} du \times u^n \quad . \quad (10.3.44)$$

Notice that for  $n < -1$  the integral can be reduced to  $n \geq 0$  case by changing the integration variable to  $v = 1/u$ .

In the following are listed the expressions of the basic integrals remaining when the contribution which is non-vanishing at  $p^2 = 0$  limit has been subtracted. As already found,  $s^\pm$  contributions are identical with  $r^\mp$  contributions so that it is enough to multiply by a factor 2 the contributions coming from  $r^\pm$ .

1. For  $r_{i,n}^+$  one obtains following integrals.

$$\begin{aligned} i_s & \sum_n r_{1n}^+ \sum_r V(1, 1, r) I(n, r, u_{max,s}) = \sum_n r_{1n}^+ I_1(n, r, u_{max,s}) \quad , \\ i_t & \sum_n r_{2n}^+ \sum_r V(2, 1, r) I(n, r, u_{max,t}) = \sum_n r_{2n}^+ I_2(n, u_{max,t}) \quad , \\ j_s + k_s & \sum_n r_{3n}^+ \sum_r V(2, 1, r) I(n, r, u_{max,s}) = \sum_n r_{3n}^+ I_2(n, u_{max,s}) \quad , \\ j_t + k_t & \sum_n r_{4n}^+ \sum_r V(1, 1, r) I(n, r, u_{max,t}) = \sum_n r_{4n}^+ I_1(n, u_{max,t}) \quad , \\ \\ I_i(n, u_{max}) & = -(i-1) \times \log(2) J_n(u_{max}) \\ & + \sum_{r=1/2,1} (-1)^{2r} (I_n(\frac{2^r}{x_k}, u_{max}) + (-1)^i I_n(-\frac{2^r}{x_k}, u_{max})) \quad . \end{aligned} \quad (10.3.45)$$

2. The integration of negative powers requires the change of variable  $u \rightarrow u^{-1} = v$ ,  $du = -v^{-2} dv$ . For  $r_{i,n}^-$  one has

$$\begin{aligned} i_s & \sum_n r_{1n}^- \sum_r V(1, 1, r) I(n, r, u_{max,s}) = \sum_n r_{1n}^- I_1(n, u_{max,s}) \quad , \\ i_t & \sum_n r_{2n}^- \sum_r V(2, 1, r) I(n, r, u_{max,t}) = \sum_n r_{2n}^- I_2(n, u_{max,t}) \quad , \\ j_s + k_s & \sum_n r_{3n}^- \sum_r V(2, 1, r) I(n, r, u_{max,s}) = \sum_n r_{3n}^- I_2(n, u_{max,s}) \quad , \\ j_t + k_t & \sum_n r_{4n}^- \sum_r V(1, 1, r) I(n, r, u_{max,t}) = \sum_n r_{4n}^- I_1(n, u_{max,t}) \quad , \\ \\ I_i(n > 1, u_{max}) & = - \sum_r (-1)^{2r} (I_{n-2}(\frac{x_k}{2^r}, \frac{1}{u_{max}}) + (-1)^i I_{n-2}(-\frac{x_k}{2^r}, \frac{1}{u_{max}})) \quad (10.3.46) \\ I_i(n = 1, u_{max}) & = (i-1) \times \log(2) J_{-1}(u_{max}) \\ & - \sum_{r=1/2,1} (-1)^{2r} (I_{-1}(\frac{2^r}{x_k}, u_{max}) + (-1)^i I_{-1}(-\frac{2^r}{x_k}, u_{max})) \quad . \end{aligned}$$

These expressions make sense for the values of  $|u_0|$ , which are not too far from unity. For very large or small values of  $|u_0|$   $F_i$  are very near to zero or constant. The small corrections come in powers of  $p/m_k$  and are typically extremely small. This means that in the case of  $I_i(n = 1, u_{max})$  the large contribution  $(i-1) \times \log(2) J_{-1}(u_{max})$  must be compensated by the contribution from the sum term. Numerically the compensation takes place in so poor an accuracy that the error is much larger than the magnitude of the actual contribution. Hence a special treatment is necessary. The large logarithmic term in  $F_2$  cancels as one expresses  $\log(|u \pm u_0|)$  terms as  $\log(|1 \mp u/u_0|) + \log(|u_0|)$  so that only  $\log(|1 \mp u/u_0|)$  terms remain and give a contribution of order  $1/u_0 \simeq p/m_k$ .

### Analytic expressions for the basic integrals

One can deduce explicit analytic expressions for almost all basic integrals in terms of elementary functions.

1. Reduction of  $k < -1$  case to  $k \geq 0$  case

The first thing is to notice that integrals  $I_{k < -1}(u_0, u_{max})$  reduce to corresponding integrals with  $k \geq 0$ .

$$I_{k < -1}(u_0, u_{max}) = I_{|k|-2}(0, u_{max}^{-1}) - I_{|k|-2}(|1/u_0|, u_{max}^{-1}) - \frac{1}{|k|-1} \log(|u_0|) \times (u_{max}^{-|k|+1} - 1) . \tag{10.3.47}$$

In the expression for  $I_i$  ( $i$  labels  $F_i$ ) the first terms cancel each other so that one has

$$I_{i, k < -1}(u_0, u_{max}) = 2 \sum_{r=1/2, 1} (-1)^{2r} \left[ - (I_{|k|-2}(x_k 2^{-r}, u_{max}^{-1}) + (-1)^i I_{|k|-2}(-x_k 2^{-r}, u_{max}^{-1})) - \frac{(i-1)}{|k|-1} \log(2^r/x_k) \times (u_{max}^{-|k|+1} - 1) \right] . \tag{10.3.48}$$

For  $k \geq 0$  and  $|u_0| \leq 1$  the explicit expression for  $I_k(u_0, u_{max})$  reads as

$$I_{k \geq 0}(u_0, u_{max}) = \sum_{l=0}^k b(k, l) \frac{(-1)^{k-l} u_0^{k-l}}{l+1} \left[ (u_{max} + u_0)^{l+1} (\log(|u_{max} + u_0|) - \frac{1}{l+1}) - (1 + u_0)^{l+1} (\log(|1 + u_0|) - \frac{1}{l+1}) \right] . \tag{10.3.49}$$

2. Alternative form of the integrals  $I_{k \geq 0}(u_0, u_{max})$

For  $|u_0| \geq 1$  it is better to use the form

$$I_{k \geq 0}(u_0, u_{max}) = \frac{\log(|u_0|)}{k+1} (u_{max}^{k+1} - 1) + u_0^{k+1} \sum_{l=0}^k b(k, l) \frac{(-1)^{k-l}}{l+1} \left[ (\frac{u_{max}}{u_0} + 1)^{l+1} (\log(|\frac{u_{max}}{u_0} + 1|) - \frac{1}{l+1}) - (\frac{1}{u_0} + 1)^{l+1} (\log(|\frac{1}{u_0} + 1|) - \frac{1}{l+1}) \right] . \tag{10.3.50}$$

This expression is numerically unstable for  $u_0 \gg 1$  (UV limit) and  $u_0 \ll 1$  The simplest manner to avoid this kind of problems is to expand the logarithms  $\log(|1 + 2^{-r} x_k u|)$  appearing in  $F_i$  as Taylor polynomials and summing various contributions analytically.

3. Expression for  $I_{k=-1}(u_0, u_{max})$

Only  $I_{-1}(u_0 \neq 0, u_{max})$  does not allow expression in terms of elementary functions.

1. In the regions  $u_{max} < |u_0|$  and  $|u_0| < 1$  one can write

$$I_{-1}(u_0, u_{max}) = \log(|u_0|) \log(u_{max}) + F(\frac{u_{max}}{u_0}) - F(\frac{1}{u_0}) , \quad u_{max} < |u_0| , \tag{10.3.51}$$

$$I_{-1}(u_0, u_{max}) = \frac{1}{2} \log^2(u_{max}) - F(\frac{u_0}{u_{max}}) + F(u_0) , \quad |u_0| < 1 ,$$

and approximate  $F(x)$  using Taylor polynomial.

2. For  $u_0 > 0$  and  $1 < u_0 < u_{max}$  one obtains the following expression

$$I_{-1}(u_0, u_{max}) = \log(2) \int du \times u^{-1} + \int du \times u^{-1} \log(1 + (\frac{u+u_0}{2} - 1))$$

$$= \log(2) \log(u_{max}) + I(u_{max}) - I(1) , \tag{10.3.52}$$

$$I(u) = -\frac{1}{2} \sum_{k>0} \frac{x^k}{k} \left[ \log(1+x) - \sum_{l=1}^k \frac{(-1)^{l+1} x^l}{l} \right] , \quad x = \frac{u_0 + u - 2}{2 - u_0} .$$

The coefficient of  $\frac{x^k}{k}$  is the remainder associated with the  $k+1$ :th Taylor polynomial of  $\log(1+x)$ .

3. For  $u_0 < 0$  and  $1 < |u_0| < u_{max}$  one can expand  $u$  in  $1/u$  factor in powers of  $(u - u_0)/u_0$  and integrate the Taylor expansion term by term. This gives

$$I_{-1}(u_0, u_{max}) = I(u_{max}) - I(1) , \quad (10.3.53)$$

$$I(u) = \log(|u_0 x|) \log(1 + x) - F(x) , \quad x = \frac{u - |u_0|}{|u_0|} .$$

4. *Expression for  $I_{i,k=-1}(u_0, u_{max})$*

One can perform the sum over integrals associated with  $F_i$  and corresponding to opposite values of  $u_0$ .

1. The integrals can be combined for  $F_i$  as

$$I_{i,-1} = I_{-1}(u_0, u_{max}) + (-1)^i I_{-1}(-u_0, u_{max}) , \quad (10.3.54)$$

$$u_0 = \frac{2^r}{x_{max}} \quad \text{for } r^+, s^- , \quad u_0 = \frac{x_{max}}{2^r} \quad \text{for } r^-, s^+ .$$

The definition of  $u_0 > 0$  is dictated by whether  $x_k u$  ( $r^\pm$ ) or  $x_k/u$  ( $s^\pm$ ) appears in the logarithm and whether  $u$  ( $r^+, s^-$ ) or  $1/u$  ( $r^-, s^+$ ) is used as the integration variable.

2. In the regions  $u_{max} < |u_0|$  and  $|u_0| < 1$  the functions  $I_{i,-1}(\frac{2^r}{x_{max}}, u_{max})$  can be expressed as

$$I_{i,-1}(u_0, u_{max}) = 2(i-1) \log(2) \times \log(u_{max})$$

$$+ \sum_{r=1/2,1} (-1)^{2r} \left[ F^i\left(\frac{u_{max}}{u_0}\right) - F^i\left(\frac{1}{u_0}\right) \right] , \quad u_{max} < u_0 , \quad (10.3.55)$$

$$I_{i,-1}(u_0, u_{max}) = - \sum_{r=1/2,1} (-1)^{2r} \left[ F^i\left(\frac{u_0}{u_{max}}\right) - F^i(u_0) \right] , \quad u_0 < 1 .$$

3. In the regions  $1 < |u_0| = |u_0| < u_{max}$  the opposite signs of  $u_0$  correspond to different analytic expressions appearing in Eqs. 10.3.51 and 10.3.52 and one cannot combine them to a simpler function.

**The treatment of  $|x_k| \ll 1$  and  $|x_k| \gg 1$  cases**

The treatment of  $|x_k| \ll 1$  and  $|x_k| \gg 1$  cases requires special care since the formal approach using integral functions approach fails because of numerical in-accuracies. The best manner to proceed is to expand the logarithms in  $F_i$  as power series with respect to a suitably selected small quantity and approximate them with their Taylor polynomials.

1. *Small values of  $x_k$*

Consider first the case  $x_k \ll 1$ . This corresponds to momentum  $p \sim 2^{-k_0}$  with  $k_0 > k$  and is encountered for large loop momenta. One can express  $\log(1 + \epsilon 2^{-r} x_k u)$  as power series using  $\epsilon_{r,k} = 2^{-r} x_k$  as a small parameter to obtain

$$I_n(\epsilon, \epsilon_{r,k}) = \int u^n \log(1 + \epsilon \epsilon_{r,k} u) = \sum_{l>0} \frac{\epsilon^l \epsilon_{r,k}^l (-1)^{l+1}}{l} J_{n+l}(u_{max}) , \quad J_n = \int_1^{u_{max}} u^n du . \quad (10.3.56)$$

This gives



$$\begin{aligned}
 I(n \geq 0, \epsilon, \epsilon_{r,k}) &= \sum_{l>0} \frac{\epsilon^l \epsilon_{r,k}^l (-1)^{l+1}}{l(n+l+1)} (u_{max}^{n+l+1} - 1) , \\
 I(n < 0, \epsilon, \epsilon_{r,k}) &= \sum_{l>0, l \neq n-1} \frac{\epsilon^l \epsilon_{r,k}^l (-1)^{l+1}}{l(n+l+1)} (u_{max}^{n+l+1} - 1) + \frac{\epsilon_{r,k}^{n-1} (-1)^n}{n-1} \log(u_{max}) .
 \end{aligned}
 \tag{10.3.57}$$

The contributions to  $F_i$  can be summed so that big contributions canceling each other do it also numerically.

1. For  $F_1$  contributions with  $\epsilon = \pm 1$  sum up with opposite overall sign and the overall contribution contains only odd powers of  $\epsilon_{r,k}$ .

$$\begin{aligned}
 \sum_{r,\epsilon} f_1(\epsilon) I(n, \epsilon, \epsilon_{r,k}) &= \sum_{l>0} C_{2l-1} J_{n+2l-1}(u_{max}) , \\
 C_l &= 2 \sum_{r=1/2,1} (-1)^{2r} \frac{\epsilon_{r,k}^l}{l} .
 \end{aligned}
 \tag{10.3.58}$$

2. For  $F_2$  contributions with  $\epsilon = \pm 1$  sum up with same sign and the overall contribution contains only even powers of  $\epsilon_{r,k}$ .

$$\sum_{r,\epsilon} f_2(\epsilon) I(n, \epsilon, \epsilon_{r,k}) = - \sum_{l>0} C_{2l} J_{n+2l}(u_{max}) .
 \tag{10.3.59}$$

2. Large values of  $x_k$

Second situation requiring special treatment corresponds to a momentum which is large in the p-adic length scale  $k$  considered so that one has  $k \gg k_0$ . Small loop momenta correspond to this case. By replacing  $\epsilon_{r,k}$  with  $M_{r,k}$  one can write

$$I_n(\epsilon, M_{r,k}) = \int du \times u^n \log(1 + \epsilon M_{r,k} u) = \int du \times u^n \log(M_{r,k}) + \int du \times u^n \log(u + M_{r,k}^{-1}) .
 \tag{10.3.60}$$

The sum of the first terms vanishes for  $F_1$  ( $i_s$  and  $j_t + k_t$ ). For  $F_2$  ( $i_t$  and  $j_s + k_s$ ) it gives overall contribution equal to

$$-J_n(u_{max}) \log(2) .
 \tag{10.3.61}$$

Note that the contribution - although large - does not depend on the scale of  $M_{r,k}$  at all. In the second term Taylor expansion in power series gives

$$\int du \times u^n \log(u) + \sum_{l>0} I_{l+n} \frac{\epsilon^n 2^{-nr} M_{r,k}^n (-1)^{l+1}}{l} , \quad J_r(u_{max}) = \int_1^{u_{max}} u^r du .
 \tag{10.3.62}$$

$\int du \times u^k \log(u)$  terms sum up to zero in both  $F_1$  and  $F_2$  and the overall integral reduces to the sum of the remaining terms.

1. For  $F_1$  contributions with  $\epsilon = \pm 1$  sum up with opposite overall sign and the overall contribution contains only odd powers of  $M_{r,k}$ .

$$\sum_{r,\epsilon} f_1(\epsilon)I(n, \epsilon, M_{r,k}) = \sum_{l>0} C_{2l-1}J_{n-2l+1}(u_{max}) ,$$

$$C_l = 2 \sum_{r=1/2,1} (-1)^{2r} \left(\frac{x_k}{2^r}\right)^l \frac{1}{l} . \tag{10.3.63}$$

Note that the only difference to the previous case is  $x_k/2^r \rightarrow 2^r/x_k$  in the formula of  $C_l$ .

2. For  $F_2$  contributions with  $\epsilon = \pm 1$  sum up with same sign and the overall contribution contains only even powers of  $M_{r,k}$  (recall that also the additional contribution given by Eq. 10.3.61 is present).

$$\sum_{r,\epsilon} f_2(\epsilon)I(n, \epsilon, M_{r,k}) = - \sum_{l>0} C_{2l}J_{n-2l} . \tag{10.3.64}$$

3. The total contribution in the case of  $F_i$  can be written as

$$I_{i,n} = -J_n(u_{max})\log(2) + (-1)^{i-1} \sum_{l>0} C_{2l-1+(i-1)}J_{n-2l+1-(i-1)} . \tag{10.3.65}$$

**Pole contributions**

Tedious calculation allows to derive explicit expressions for the integrals of rational functions of  $exp(\eta)$  defining the pole contributions. There are two contributions to the integral and they can be reduced to same kind of integral by the changing the integration variable from  $u$  to  $1/u$  in the contribution. For space-like contributions the integrals can be expressed in the form

$$J_{s,+} + K_{s,+} = I(u_{max,s,+}) - I(u_{min,s,+}) ,$$

$$J_{s,-} + K_{s,-} = -I(u_{max,s,-}^{-1}) + I(u_{min,s,-}^{-1}) ,$$

$$I(u) = C_s \times \left[ \sum_{n \geq 1} \frac{p(n)}{n+1} u^{n+1} + p(-1)\log(u) \right] , \tag{10.3.66}$$

$$\tag{10.3.67}$$

$$p(-1) = \frac{1}{8} , \quad p(1) = -\frac{1}{8} \quad p(3) = -\frac{3}{8} \quad p(5) = \frac{1}{8} .$$

$$\tag{10.3.68}$$

Here the  $u_{max,s,+}$  and  $u_{min,s,-}$  are subject to the additional condition that the the pole momentum is inside the p-adic half octave considered. Same applies to the integration boundaries in time-like case.

For time-like contributions the integrals can be expressed in the form

$$\begin{aligned}
 J_{t,+} + K_{t,+} &= I(u_{max,t,+}) - I(u_{min,t,+}) , \\
 J_{t,-} + K_{t,-} &= -I(u_{max,t,-}^{-1}) + I(u_{min,t,-}^{-1}) , \\
 I(u) &= \sum_{n>1} \frac{p(n)u^{n+1}}{n+1} + \frac{p(1)}{6} \log(3u^2 + 1) + r(-1) \left[ \log(u) - \frac{\log(3u^2+1)}{2} \right] , \\
 C_t &= \sqrt{-1} \times 32 \times \pi^2 , \\
 p(n > 0) &= \frac{1}{3} \left[ -\frac{p(n+2)}{3} + r(n+2) \right] , \quad p(n > 5) = 0 , \\
 r(-1) &= \frac{1}{8} , \quad r(1) = \frac{1}{2} , \quad r(3) = -\frac{5}{4} , \quad r(5) = \frac{1}{2} , \quad r(7) = \frac{1}{8} .
 \end{aligned}
 \tag{10.3.69}$$

Since the entire integration range for  $\eta$  for a given value of  $k$  need not to correspond to the roots  $k_+$  resp.  $k_-$  belonging to  $k$ :th half half octave, the determination of the bounds of hyperbolic integral requires a special care. One has two roots  $k_+ = p \exp(\eta)$  and  $k_- = p \exp(-\eta)$  in both time-like and space-like case. For  $k$ :th p-adic half octave the questions are following. Does  $p$  belong to the  $k$ :th octave? Does  $k_+(max, k) = pu_{max}(k)$  belong to it? Does  $k_-(min, k) = pu_{max}^{-1}(k)$  belong to it? The answers to these three questions determine the limits of the  $\eta$  integration. There are  $2^3$  bit combinations  $(b_0, b_+, b_-)$  formed by the answers to the question 'Does  $p$  resp.  $k_+(max, k)$  resp.  $k_-(min, k)$  belong to the  $I_k = [m_k, \sqrt{2}m_k]$ ?'. The following table gives the integration ranges for the bit combinations for which they are non-empty for either  $k_+$ ,  $k_-$  or both.

$(b_0, b_+, b_-)$	pole	$u_{lower}$	$u_{upper}$	
(111)	$k_+ : 1$ $k_- : 1$	1	$u_{max}(k)$ $u_{max}(k)$	
(110)	$k_+ : 1$ $k_- : 1$	1	$u_{max}(k)$ $Min(\frac{p}{m_k}, u_{max}(k))$	
(101)	$k_+ : 1$ $k_- : 1$	1	$Min(\frac{\sqrt{2}m_k}{p}, u_{max}(k))$ $u_{max}(k)$	(10.3.70)
(100)	$k_+ : 1$ $k_- : 1$	1	$\frac{\sqrt{2}m_k}{p}$ $\frac{p}{m_k}$	
(010)	$k_+ : \frac{m_k}{p}$	$\frac{m_k}{p}$	$u_{max}(k)$	
(001)	$k_- : \frac{p}{\sqrt{2}m_k}$	$\frac{p}{\sqrt{2}m_k}$	$u_{max}(k)$	.

**General expression for the normalization factor**

To summarize, one can write the expression for the loop integral as

$$\begin{aligned}
 X &= Ap^2 P^{\mu\nu} , \\
 A &= \sum_{k=k_{min}}^{k_{max}} A(k) , \\
 A(k) &= \frac{1}{p^2} [-I_{pole}(k) - I_{P,1}(k) - I_2 + J_{pole}(k) + J_{P,1}(k) + J_2(k)] .
 \end{aligned}
 \tag{10.3.71}$$

Propagator normalization factor is given by

$$N = \frac{1}{A} . \quad (10.3.72)$$

The above calculations are carried out by assuming that 2-adic length scale defines the length scale resolution. The scaling up of the UV cutoff length scale from  $\mu(2) = \sqrt{2}m(CP_2)$  to  $2^{-k/2}m(CP_2)$  requires only the replacement  $x = m(CP_2)/p$  appearing in the function  $F(x_k, \exp(\pm\eta))$  with  $x(k) = 2^{-(k-1)/2}m(CP_2)/p$ . The lowest order approximation must result if one puts  $p = 0$  in the arguments of the logarithms so that only  $p^2$  term remains in the propagator. This is indeed the case as already found.

### 10.3.6 The evolution of $1/\alpha_{em}(p)$ for given IR cutoff for loop momenta

The following plots illustrate the evolution of the fine structure constant a function of the mass of virtual photon. All the plots are associated with the model for the hyperbolic cutoff parameterized as  $\sinh(\eta_t) \leq a \times b^{-1/3}$ ,  $a = 0.22050469512552$ ,  $b = 1/3$ , reproducing the experimental value  $1/\alpha_{em} = 137.035999070$  of the fine structure constant at electron length scale for IR cutoff  $k_{max} = 127$  and its value at intermediate boson length scale for  $k_{max} = 89$ . The figures demonstrate following.

1. From figures 1 and 2 it is clear that only the scenario in which the IR cutoff  $k_{max}$  for loop momenta satisfies  $k_{max} > k_0(p)$ , where  $k_0(p)$  is the p-adic mass scale of the momentum of virtual gauge boson, makes sense.
2. For  $k_0 > k_{max}$  there are two reasons for the failure. A large imaginary pole contribution breaking unitarity (Figure 2) is generated and the evolution for gauge couplings is unrealistic (Figure 1) due to the large contributions related to the presence of the pole.
3. In the main text it is proposed that it might be possible to fix the hyperbolic cutoff from quantum criticality by requiring that the inverses of bare gauge couplings vanish at the end point of the p-adic half octave for  $k_0 = k_{max} + n$ , where  $n$  is small integer. The finding that the real part for the inverse of gauge coupling changes sign for  $k_0 = 90$  for  $k_{max} = 89$  at the lower end of the p-adic half octave (Figure 3) raises the hope that the hyperbolic cutoff for various values of  $k$  could be determined from this condition by starting from  $k_{max} = 1$  or 2.

#### Failure of the model allowing $k_0 > k_{max}$

Figures 1 and 2 demonstrate that loop momenta must be above the p-adic mass scale of the gauge boson momentum. Figure 1 demonstrates that the ratio  $r = \alpha_{em}/\alpha_{em,pred}(p_k)$  where  $\alpha_{em} = 137.035999070$  is the experimentally determined fine structure constant at electron length scale and  $\alpha_{em,pred}(p_k)$  is the predicted fine structure constant for virtual photon mass  $p_k = \sqrt{2}m_k = 2^{-(k-1)/2}xm(CP_2)$ ,  $k = 2, \dots, 127$ ,  $x \in \{2^{-1/2}, 2^{-1/4}, 1\}$ . There is a large oscillation of the ratio as a function of  $k$  at the upper end of the interval. The deviation of the prediction from unity is so large and so different from expectations that it is safe to conclude that for momentum of virtual gauge bosons characterized by the p-adic length scale  $k_0$  IR cutoff  $k_{max}$  for the loop momenta must satisfy  $k_{max} \geq k_0 + n$ ,  $n$  a small positive integer. This interpretation conforms with the general view provided by zero energy ontology and the assignment of loop corrections with sub-CDs.

Figure 2 represents the ratio  $\alpha_{em}Im \times Im(1/\alpha_{em}(p))$  as a function of virtual photon mass for  $p(k_0) = \sqrt{2}xm_k = 2^{-(k_0-1)/2}xm(CP_2)$ ,  $k = 2, \dots, 127$ ,  $x \in \{2^{-1/2}, 2^{-1/4}, 1\}$ . Unless one assumes that IR cutoff for loop momenta is larger than mass  $p$ , one encounters difficulties with unitarity since the pole in the integral defining the inverse of the bosonic propagator induces imaginary part to the normalization factor  $X$  of the propagator. In order to avoid obviously non-physical predictions the condition  $Im(X)\alpha_{em} \ll 1$  should hold true. For the model explaining the behavior of the fine structure constant at  $p^2 = 0$  limit  $Im(X)\alpha_{em}$  does not satisfy this criterion as Fig. 5 demonstrates. The value of the imaginary part of normalization is typically 10 times larger than that of real part.

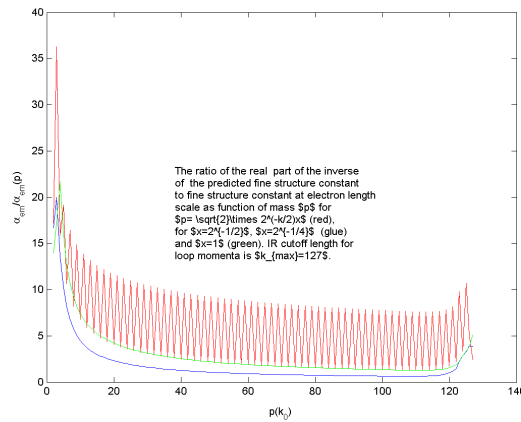

Figure 10.1: The evolution of the ratio  $r = \alpha_{em}/\alpha_{em,pred}(p)$ , where  $\alpha_{em}$  is the experimentally determined value of the fine structure constant at electron length scale and  $\alpha_{em,pred}(p_k)$  for  $p_k = \sqrt{2}m_k = 2^{-(k-1)/2}xm(CP_2)$ ,  $k = 2, \dots, 127$ ,  $x \in \{2^{-1/2}, 2^{-1/4}, 1\}$ . Note that the three points correspond to the lower end, middle point, and upper end of the p-adic mass scale range labeled by the integer  $k_0$ .

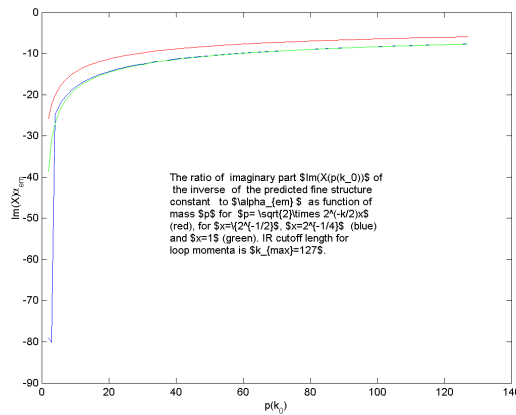

Figure 10.2: The graph represents the quantity  $Im(X)\alpha_{em}$ , where  $Im(X)$  is imaginary pole contribution to the normalization factor of the inverse propagator for momenta  $p_{k_0} = \sqrt{2}m_k = 2^{-(k_0-1)/2}xm(CP_2)$ ,  $k = 1, \dots, 127$ ,  $x \in \{2^{-1/2}, 2^{-1/4}, 1\}$  and assuming  $k_{max} = 127$ .

**Behavior of the fine structure constant for  $k_0(p) < k_{max}$  option**

Figures 1 and 2 allow to conclude that  $k_0(p) < k_{max}$  is the only sensible option. Figure 3 illustrates the evolution of the fine structure constant with the interpretation forced by the above findings for masses  $p_k = \sqrt{2}xm_{k_0} = 2^{-(k-1)/2}xm(CP_2)$ ,  $k_0 = 90, \dots, 127$ ,  $x \in \{2^{-1/2}, 2^{-1/4}, 1\}$  assuming that  $k_{max} = 89$  defining intermediate gauge boson mass scale defines the IR cutoff for the loop momenta. The behavior approaches rapidly the behavior at  $p^2 = 0$  limit. The value of the ratio is 0.9352 at electron length scale giving  $\alpha_{em}(89) = 128.1561$  to be compared with the prediction  $\alpha_{em}(89) = 128.1631$   $p^2 = 0$  limit. The value of the fine structure constant is somewhat larger for  $p = \sqrt{2}m_{89}$  than for  $p^2 = 0$  as expected for U(1) coupling constant evolution involving only fermionic loops.

From figure 3 it is clear that fine structure constant can become slightly negative at the upper end

of the half octave  $k_{max} - 2$  for  $k_{max} = 89$ . This raises the hope that hyperbolic cutoff and therefore the entire coupling constant evolution apart from corrections coming from bosonic loops could be fixed from the condition that gauge couplings vanish at this point. The physical interpretation for  $k_{max}$  would be that  $k_0 > k_{max} + 1$  zero energy states which are within the reach of the measurement resolution whereas for  $k_0 \leq k_{max} + 1$  they correspond to quantum fluctuations.

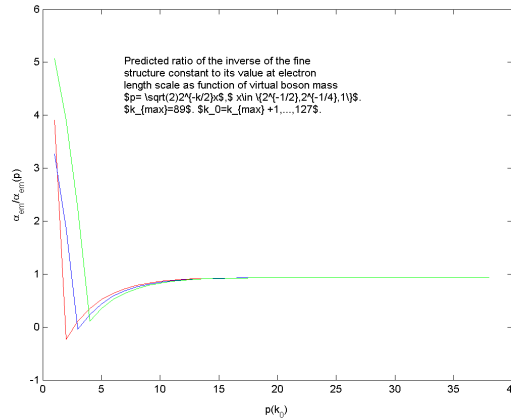

Figure 10.3: The evolution of the ratio  $r = \alpha_{em} / \alpha_{em,pred}(p_k)$  for  $k_{max} = 89$  as IR cutoff for loop corrections and for momenta  $p_k = \sqrt{2}m_k = 2^{-(k-1)/2}xm(CP_2)$ ,  $k = 90, 127$ ,  $x \in \{2^{-1/2}, 2^{-1/4}, 1\}$ .

**Contribution of a given p-adic length scale to the fine structure constant**

Figure 4 illustrates how the contribution  $X(k)$  from a given p-adic length scale  $k$  to the normalization factor of the inverse of the fine structure constant depends on  $k$  for  $k_{max} = M_{127}$  and  $p = \sqrt{2} \times 2^{-k_0/2}mCP_2$ ,  $k_0 = 89$  (this corresponds to the non-physical option) What is plotted is the contribution to the quantity  $Re(1/\alpha_{em}(p))\alpha_{em}$  as a function of  $k$ . The contributions from negative and positive powers of  $u = cosh(\eta)$  to  $1/\alpha_{em}(p)$  at given p-adic length scale  $k$  -including the p-adic scale  $k_0$  corresponding to the momentum  $p$  of gauge boson, are of opposite sign and tend to cancel each other.

Figure 5 illustrates  $\alpha_{em} / \alpha_{em}(p)$  for the physical option  $k_{max} = 89$ ,  $k_0 = 107$ .

**10.4 How quantum criticality could predict the evolution of hyperbolic cutoff?**

In this section the path leading to the recent view about how quantum criticality fixes hyperbolic cutoff as a function of the p-adic scale  $k$  is described in detail. To help reader I have added a summary about how ideas involved and led also to a more detailed understanding of what coupling constant evolution really means. Also a connection with p-adicization and twistorialization using Cutkosky rule based unitarization emerged during this process.

**10.4.1 Summary about how ideas about quantum criticality have evolved**

This chapter like all other chapters of books reflects much more the evolution of ideas rather than its final outcome and a brief summary about what happened might minimize reader’s confusion. The idea which led to the realization of what QFT limit of TGD could be is simple.

1. Only fermions are fundamental particles in quantum TGD and bosons are fermion-antifermion pairs with fermion and antifermion quantum numbers residing at the opposite 3-D light-like

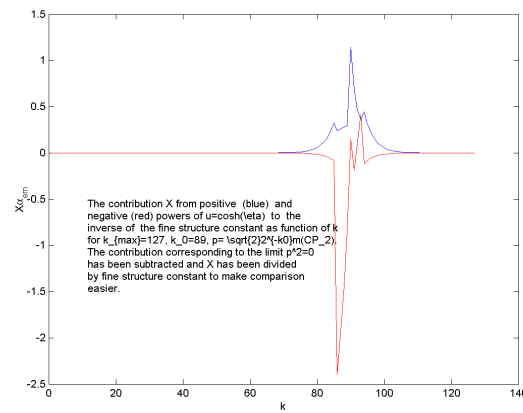

Figure 10.4: The quantity  $X(k)\alpha_{em}$  characterizing the contribution from a given p-adic length scale  $k$  to  $1/\alpha_{em}(p)$  as a function of p-adic length scale  $k$  for IR cutoff  $k_{max} = 127$  and  $p = \sqrt{2} \times 2^{-k_0/2} mCP_2$ ,  $k_0 = 89$ .

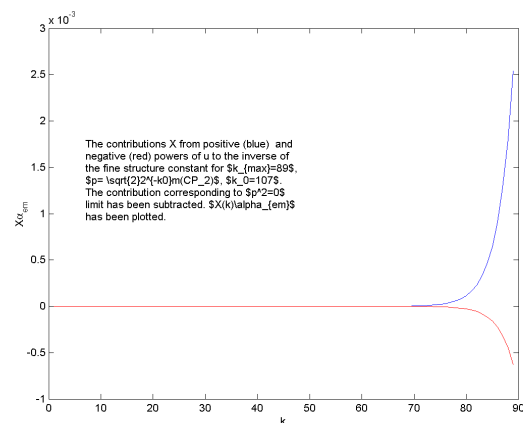

Figure 10.5: The quantity  $X(k)\alpha_{em}$  characterizing the contribution from a given p-adic length scale  $k$  to  $1/\alpha_{em}(p)$  as a function of p-adic length scale  $k$  for IR cutoff  $k_{max} = 89$  and  $k_0 = 107$ .

throats of wormhole contacts which are surfaces possessing Euclidian signature of induced metric and are glued to space-time sheets having Minkowskian signature of induced metric. Feynman diagrams can therefore be understood in terms of space-time topology and space-time metric. The interpretation of generalized Feynman diagrams differs dramatically from that for stringy diagrams since vertices are points where light-like 3-surfaces join together just like likes of ordinary Feynman diagram do. Stringy diagrams provide a space-time correlate for the propagation of particle along two different routes followed by fusion and interference.

2. Only fermions are fundamental fields in TGD. This suggests that gauge bosons, which have components of induced spinor connection and projections of  $CP_2$  Killing vector field as classical geometric correlates, should emerge in some sense at QFT limit. In other words, the action for QFT approximating TGD contains nothing but Dirac action coupled to gauge potentials, and the bosonic action containing YM term plus infinite number of vertices defined by closed fermion loops is generated radiatively. This approach leads to a generalization of Feynman rules and

in principle predicts all coupling constants and their evolution without any input parameters except  $CP_2$  size and quantum criticality. p-Adic mass calculations demonstrated already 15 years ago that one can understand the mysterious proton mass to Planck mass ratio and elementary particle mass scales and even masses number theoretically.

3. An essential element of the approach is a formulation for UV cutoff. A cutoff in both mass squared and hyperbolic angle is necessary since Wick rotation does not make sense in TGD framework. By assuming a geometrically very natural hyperbolic UV cutoff motivated by zero energy ontology one can understand the evolution of the standard model gauge couplings and reproduce correctly the values of fine structure constant at electron and intermediate boson length scales. Also asymptotic freedom follows as a basic prediction. Contrary to the original beliefs propagator generates a mass term unless the hyperbolic cutoffs for time-like and space-like gauge boson momenta are in a definite relation. One could criticize this relation and argue that perhaps super-conformal symmetries might help to get the cancelation with identical cutoffs. It seems that this is not the case.

The UV cutoff for the hyperbolic angle as a function of p-adic length scale is the ad hoc element of the model in its recent form. How to formulate quantitatively the quantum criticality in terms of the behavior of the hyperbolic cutoff as function of p-adic length scale became therefore the basic problem and led what might like a numerics inspired random walk -or perhaps better to say sleep walk - towards what I believe to be the solution of the problem. During this kind of heavy numerical calculations one realizes how important it would be to have a colleague replicating the calculations. One can never be quite sure about signs and numerical factors.

1. The process gradually led to an improved understanding of the notion of coupling constant evolution itself. The fermionic loop integral contains a propagator pole contributing imaginary part to the inverse propagator and numerical calculations demonstrated that this contribution is too large to be physically acceptable. Moreover, the sign of coupling strength becomes negative for fermion masses above certain critical mass defining the IR cutoff for the loop momenta. The only manner to avoid difficulties is to assume that loop momenta are always below the p-adic mass scale associated with the momentum of the gauge boson. The assumption eliminates the imaginary part of propagator and keeps coupling constant strength positive. This also gives precise content to the notion of coupling constant evolution since it assigns to the mass scale of p IR cutoff  $k_{max}$  such that for  $k > k_{max}$  coupling constant strength is positive. A nice geometric interpretation is possible in zero energy ontology: loop corrections corresponding to geometric details sufficiently smaller than the length scale assignable to the mass squared.
2. The next idea was that perhaps one could fix the cutoff on hyperbolic angle (hyperbolic cutoff) by some naturally occurring condition. The first guess was that the sign of the coupling constant strength changes at either end of the p-adic half octave for the mass of gauge boson. The motivation to this idea could have come from the calculation of the momentum at which the sign changes for the model reproducing physically reasonable coupling constant evolution: at long length scales the sign indeed changes very near to the end of the half-octave. Unfortunately this did not work.
3. The next guess was that the value of boson momentum at which the sign changes is as near as possible to the end of the mass squared octave. Tedious calculations in a rather arctic numerical environment demonstrated that one obtains a discrete set of coupling constant evolutions but that the hyperbolic cutoff is increasing as a function of k rather than decreasing as required by the coupling constant evolution in standard model. The increase can be understood as a positive feedback effect: the vanishing of the inverse of the coupling constant at given length scale requires a contribution, which increases as a function of the p-adic length scale since the inverse of the coupling constant itself increases. The attempts to modify the model to modify this behavior failed.
4. The next idea was that perhaps p-adic fractality helps to assign the change of the sign at the ends of half octaves or to prime for which p-adic length scale is very near to that defined by the end of the half octave ( $p \simeq 2^k$ ). p-Adic fractals were one of the first ideas about p-adic physics and quite recently that also mathematicians have discovered them. They are obtained



by mapping reals to p-adics by the inverse of the canonical identification  $I$  (or a proper variant of it) performing the arithmetics, and map the result back to reals by  $I$ . I had not found any direct application except in the case of p-adic mass calculations where p-adic mass squared is mapped to its real counterpart.

The guess was obvious. Express M-matrix element a function of standard Lorentz invariants with dimensions of mass squared so that a very close connection with mass calculations is obtained. Map the invariants to their p-adic counterparts using the inverse of  $I$ , carry out the arithmetics defining the function in the p-adicity under question, and return to the reality using  $I$ . Maybe this could allow to achieve the cancelation at the end of the p-adic octave for mass squared. I do not believe this anymore but again a wrong idea led to what looks like a real increase in the understanding of quantum TGD and how p-adic and real physics relate at the level of M-matrix. One nice finding was that p-adic existence forces the loop masses to be above the mass of virtual gauge boson forced by purely physical conditions. It however seems that one must introduce transcendentals like  $\log(2)$  and  $\pi$  so that an algebraically infinite-dimensional and basically non-algebraic extension of p-adic numbers is unavoidable.

5. The p-adicization program for M-matrix involve a technical difficulty which led to a further progress. It is not possible to perform loop integrals in the p-adic context. All loop integrals must be carried out in the real context and the resulting functions must be p-adicized. For the bosonic vertices defined as purely fermionic loops this is not a problem but the situation changes for the expansion of the M-matrix involving both bosonic and fermionic lines inside loops. The same problem is encountered in the twistorialization and the solution of the problem is based on Cutkosky rules allowing unitarization of the tree amplitudes in terms of  $TT^\dagger$  contribution involving only light-like momenta seems to be the only working option and requires that  $TT^\dagger$  makes sense p-adically. This idea is actually very near to the original idea that only light-like momenta appear in loops so that twistorialization is elegant.  $TT^\dagger$  indeed allows interpretation in terms of loops so that I was not after all totally silly. The p-adic existence of the analytic continuation of  $TT^\dagger$  by dispersion relations poses strong constraints on otherwise not completely unique continuation.
6. After these steps I was mature to realize how to formulate quantum criticality in such a manner that it could fix the hyperbolic cutoff and hence coupling constant evolution uniquely. The fermionic loops defining bosonic vertices vanish when the incoming momenta are massless. This is it! The condition emerges as a consistency condition: if the vanishing does not occur for on mass shell bosons, one obtains T-matrix expressible in terms of analytic continuation of  $TT^\dagger$  and one does not have vertex identified as something irreducible anymore. The condition is suggested also by quantum criticality: the vanishing of vertices is very much analogous to the vanishing of higher functional derivatives of the action with respect to gauge fields at criticality (or derivatives of the potential function in Thom's catastrophe theory). Also the fact that only BFF vertex is fundamental vertex if bosonic emergence is accepted suggests the conditions. The vanishing of on mass shell N-vertices gives an infinite number of conditions on the hyperbolic cutoff as a function of the integer  $k$  labeling p-adic length scale at the limit when bosons are massless and IR cutoff for the loop mass scale is taken to zero. It is not yet clear whether dynamical symmetries, in particular super-conformal symmetries, are involved with the realization of the vanishing conditions or whether hyperbolic cutoff is all that is needed.

### 10.4.2 Searching for the solutions of criticality conditions

In the following criticality conditions are formulated more precisely and the results of the search for their solutions are summarized.

#### A detailed definition of the criticality conditions

The general definition of criticality should conform with  $ak^{-b}$  model for the coupling constant evolution in the sense that a small deformation of this model should result from the quantum criticality condition. Small deformation means that power law behavior should not be modified considerably (the logarithm of hyperbolic cutoff should be linear in the logarithm of  $k$ ) and the normalization at small values of

$k$  should not change much. The evolution of fine structure constant in the range  $k_{max} \in [89, 127]$  in turn fixes the value of  $a$  with high precision.

Before continuing it is convenient to introduce some notations. Let us denote by  $O(k)$  the half octave associated with  $k$  containing momenta  $p = xm_k = x2^{-k/2}m(CP_2)$ ,  $x \in [2^{-1/2}, 1)$ . Denote by  $J(k, k-1)$  the junction of  $O(k)$  and  $O(k-1)$  containing the point  $p = m_k$ . Define a distance inside half octave as in music - that is as  $d$  in  $x = 2^{d-1/2}$  so that the  $d = 1/4$  represents the middle point of the half octave and points with  $d < 1/4$  are nearer to the lower and those with  $d > 1/4$  nearer to the upper end of  $O(k)$ .

The detailed calculations of  $1/\alpha_{em}(p, k_{max})$  as a function of  $p = xm_{k_0}$  in  $ak^{-b}$  model demonstrate that the sign of  $1/\alpha_{em}(p, k_{max})$  becomes stably positive for  $k_0 \geq k_{max} + n$ , where  $n$  depends on  $k_{max}$ . The conditions are summarized in the following. The criterion has been that 5 values with distances  $d = (i-1)/2N_{max}$  in  $O(k_{max} + n_{max})$  are positive ( $N_{max} = 4$ ).

$$\begin{aligned}
n(k_{max}) &= 9 && \text{for } 1 \leq k_{max} \leq 4 \text{ ,} \\
n(k_{max}) &= 8 && \text{for } 5 \leq k_{max} \leq 8 \text{ ,} \\
n(k_{max}) &= 7 && \text{for } 9 \leq k_{max} \leq 14 \text{ ,} \\
n(k_{max}) &= 6 && \text{for } 15 \leq k_{max} \leq 22 \text{ ,} \\
n(k_{max}) &= 5 && \text{for } 23 \leq k_{max} \leq 39 \text{ ,} \\
n(k_{max}) &= 4 && \text{for } 40 \leq k_{max} \leq 71 \text{ ,} \\
n(k_{max}) &= 3 && \text{for } 72 \leq k_{max} \leq 109 \text{ ,} \\
n(k_{max}) &= 3 && \text{for } k \bmod 2 = 1 \& 110 \leq k_{max} \leq 134 \text{ ,} \\
n(k_{max}) &= 2 && \text{for } k \bmod 2 = 0 \& 110 \leq k_{max} \leq 134 \text{ ,} \\
n(k_{max}) &= 1 && \text{for } k_{max} \geq 135 \text{ .}
\end{aligned}
\tag{10.4.1}$$

For instance, for  $k_{max} \leq 4$  one has  $n(k_{max}) = 9$  and for  $k = 127$   $n(127) = 3$ .  $n(k_{max})$  is piecewise constant and monotonically decreasing as function of  $k_{max}$  except in the range  $[110, 134]$  where one has  $n(k_{max}) = 2$  for even values of  $k_{max}$  and  $n(k_{max}) = 3$  for odd values of  $k_{max}$ . Note that  $n(k_{max}) = 2$ , where oscillations set on corresponds to the p-adic length scale assignable to deuteron. The length scale range in which oscillations occur is between hadronic and atomic physics length scales.

Asymptotia is reached after  $k_{max} = 134$  - which is between electron's and atom's p-adic length scales - as  $n(k_{max})$  changes from 2 to 1.  $Y = 1/\alpha_{em}(p, k_{max})$  must vanish at the lower boundary  $O(k_{max})$  in the asymptotic region. The first prime in this range is  $k_0 = 137$  defining the p-adic length scale of atom. Note that fine structure constant  $1/\alpha_{em} \simeq 137$  is the fundamental constant of atomic physics and its value at electron length scale equals to Kähler coupling strength. .

### The behavior of the cutoff momentum as function of $k$

The attempts to realized the scenario for quantum criticality led to the question about the behavior as a function of  $k_{max}$  of the cutoff momentum  $p$  at which the inverse of propagator vanishes. If the propagator is continuous function of  $p$  this momentum should reside in the half octave  $k_{max} + n(k_{max})$ .

The calculation of the momentum value at which the inverse propagator vanishes as a function of  $k_{max}$  shows that above  $k_{max} = 61$  the cutoff momentum  $p$  tends to be very near to the upper end of the half octave for the ideal hyperbolic cutoff.

1. The first thing to notice is that there is strong correlation between the graphs of  $n(k)$  and  $p(k + n(k))/m(k + n(k))$ .
2. The behavior of  $f(k) = p(k + n(k))/m(k + n(k))$  brings in mind generalized 2-adic fractal since it typically increases essentially linearly from a minimum value  $k_0$  up to maximum value  $k_0\Delta k$  at which the value is suddenly reduced. The values of  $\Delta k$  appearing in the graph are 3, 4, 5, 7, 16, 21, 1. For  $k \geq 73$  the behave stabilizes to a 2-adic fractal for which odd values of  $k$  correspond to minima and even values of  $k$  maxima probably equal to  $\sqrt{2}$ . The numerical approach does not allow to tell whether this is the case. This means that the cutoff momenta associated with even  $k$  and its odd follower are very nearly equal. Similar situation sharpens at higher momenta and also when the end point is near 1.

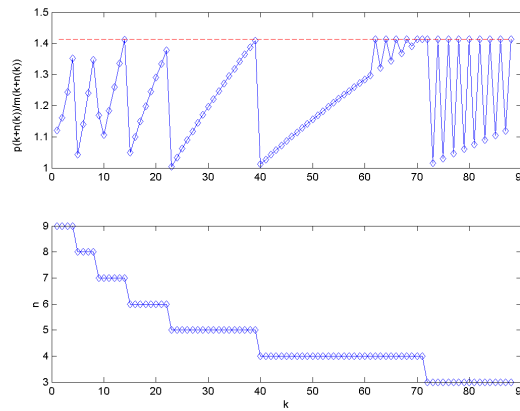

Figure 10.6: The graph represents the ratio  $p(k + n(k))/m(k + n(k))$  of the critical mass to the p-adic mass scale having variation range  $[1, \sqrt{2}]$ . Second graph representing  $n(k_{max})$  demonstrates the correlation between the two plots. The values of the calculated ratio at the upper end are not exact since the convergence to the actual value, presumably equal to  $\sqrt{2}$ , is so slow that calculation does not reach the zero in the available calculation time.

3. The calculation for  $k \in [110, 134]$  gives  $n(k_{max}) = 3$  for odd  $k_{max}$  and  $n(k_{max}) = 2$  for even  $k_{max}$  and  $f(k) = 1$ . For  $k = 135$   $n = 1$  is established. This is an alternative mechanism guaranteeing that the values of cutoff momentum are very near to each other. For large values of  $k_{max}$  the
4. The corresponding powers  $2^{\Delta k}$  could also correspond to primes near them so that one would have 2-adic fractality. The behavior of  $f(k)$  resembles population dynamics for which  $n(k)$  serves as a control parameter with breakdown of population induced by the reduction of  $n(k)$ .  $n(k)$  would be analogous to a temperature like parameter whose decrease reduces the population. Population however immediately adapts to the reduced value of the temperature. Above  $k = 73$  the dynamics becomes more like that of market economy and for large values of  $k$  not shown in the graph situation stabilizes to that of minimum population.

One might think that the change of the sign of the fine structure constant in apparently or genuinely discontinuous manner at the end point of the half-octave is due to the logarithmic singularity which moves from the range  $[1, u_{max}]$  outside it  $u = u_{max}$  and in this manner causes discontinuity. This cannot be the case since the value of  $n_{max}$  is 3 or 2 and even large in the region considered. At this moment the underlying mechanism is not understood.

This raises the question whether the phenomenon occurs only for the values  $a, b$  of the parameters of the model consistent with the coupling constant evolution. The emergence of p-adic mass scales as preferred ones would of course be a fantastic support for the model. The experimentation varying values of  $a$  ( $a = .1$  and  $a = .2$ ) however gives similar qualitative behavior at large values of  $k$ . For instance, for  $a = .2$   $p$  is at either end of the half octave for  $k_{max} = 107, 108, 109$ .

One can wonder whether the hyperbolic cutoff quite generally correspond to either end point of the half octave or a momentum given by p-adic mass scale as near as possible to the end point. One can consider various forms of the hypothesis.

1. The critical momentum at which the amplitude vanishes is always at either end point of the the half octave  $k_{max} + n(k_{max})$ . The following considerations demonstrate that this option fails.
2. The zero of  $X = 1/\alpha_{em}(k_{max})$  is as near as possible to either end point of the half octave  $k_{max} + n(k_{max}) - 1$ . The technical formulation is as the condition that both  $X$  and  $\partial_{u_{max}} X$  vanish so that  $du_{max}/dp$  at curve  $X = 0$  vanishes at criticality. This would mean kind of fixed point property. This option predicts the increase of  $u_{max}$  as function of  $k_{max}$  that is asymptotic freedom for all bare couplings. If the value of hyperbolic cutoff is small enough for  $k_{max} = 1$ ,

it could increase for small values of  $k_{max}$  and start to decrease somewhere around  $k_{max} = 74$ . Since the behavior at long length scales reflects only the net contribution from short length scales it might be possible to obtain consistency with the values of the fine structure constant at electron and intermediate boson length scales.

3. A further option is that a discontinuous change of the sign and magnitude at the end point - taking place for large values of  $k_{max}$  at least apparently - occurs quite generally. One could also argue that the inverse of coupling strength must be non-vanishing at the cutoff momentum to avoid the divergence of the propagator as momentum approaches this limit. The attempts to realize this scenario as a small deformation of  $ak^{-b}$  model however fail: it turns that  $X$  for small values of  $k$  is continuous and preserves change sign at the end point of the half-octave fixed by  $ak^{-b}$  model.
4. The behavior of  $1/\alpha_{em}(k_{max}, p)$  near critical momentum brings strongly in mind 2-adic fractals or their generalization which might be called  $2^k$ -fractals. The characteristic feature would be discontinuities at powers  $2^k$ . This behavior could be more or less equivalent with  $p \simeq 2^k$ -adic fractality. This raises the question whether the bosonic propagator should be replaced with its fractal variant so that one would obtain discontinuities and even zeros of  $1/\alpha_{em}(k_{max})$  near or at the end points half-octave for a small deformation of  $ak^{-b}$  model and whether primes  $p$  as near to  $2^k$  as possible would emerge naturally in this manner.

In the following these options are discussed in detail.

### The first model for the hyperbolic cutoff

Previous findings motivate the following concrete proposal.

1.  $Y = 1/\alpha_{em}(p, k_{max})$  vanishes at the junction  $J(k_{max} + n(k_{max}), k_{max} + n(k_{max}) - 1)$  that is for momentum  $p = m(k_{max} + n(k_{max}))$  representing the maximum momentum in  $O(k_{max} + n(k_{max}))$  if the point at which the sign changes in  $O(k_{max} + n(k_{max}) - 1)$  occurs is nearer to this junction. If the sign changes nearer to the junction of  $J(k_{max} + n - 1, k_{max} + n - 2)$  so that  $d > 1/4$  for the point in question, the sign change should take place at  $J(k_{max} + n - 1, k_{max} + n - 2)$  so that one has  $p = m(k_{max} + n(k_{max}) - 1)$ .
2. A more refined option for the identification of the cutoff momentum  $p$  would give a connection with the p-adic length scale hypothesis. The junction could be replaced with the p-adic mass scale  $p = \sqrt{q}m(CP_2) \in O(k)$  for prime  $q \in (2^{k-1}, 2^k)$  and as near as possible to the end point of the half octave. One would have  $k = k_{max} + n(k_{max})$  or  $k = k_{max} + n(k_{max}) - 1$  depending on whether the point at which sign changes is nearer to  $m(k_{max} + n)$  or  $m(k_{max} + n - 1)$ . This would provide an additional flexibility possibly significant for small values of  $k_{max}$  where small changes of the parameters affect dramatically the evolution of coupling constants in longer length scales. This option would explain the special importance of Mersenne primes and exclude Fermat primes. Note however that the primes in question are rather large and dense already for  $k_{max} = 1$ : since the prime in question is around  $2^{10}$  the variation  $\Delta p/p$  is of order  $2^{-10}$  as one moves from the end of the half octave to the nearest prime.

The computer code searching for the critical hyperbolic cutoff as a small deformation of the cutoff consistent with coupling constant evolution has rather simple structure. Similar procedure applies also if one assumes that the hyperbolic cutoff corresponds to a p-adic length scale near the end point of the half octave.

1. The program proceeds from  $k_{max} = 1$  one by one using the information obtained in previous steps to find hyperbolic cutoff at given value of  $k_{max}$  as a small deformation of that predicted by  $ak^{-b}$  model.
2. At each step the program calculates the values of  $Y = 1/\alpha_{em}(p, k_{max})$  for  $N$  points  $x(i) = 2^{-1/2+(i-1)/N}$ ,  $i = 1, N + 1$  in the interval  $O(k_{max} + n(k_{max}) - 1)$ , finds whether the sign changes occurs near the lower or upper end, and selects cutoff momentum accordingly as  $m(k_{max} + n(k_{max}))$  or  $m(k_{max} + n(k_{max}) - 1)$ . After this the program searches for two values of hyperbolic cutoff for  $k_{max}$  such that the signs of  $Y$  for them are different and finds the value of hyperbolic cutoff giving zero of  $Y$  by (say) interval halving.

This simple picture could fail and indeed seems to do it.

1.  $n(k_{max})$  need not remain same when cutoff  $ak^{-b}$  is replaced with the perturbed cutoff. Hence it seems that one must regard  $n(k_{max} = 1)$  as an integer labeling different coupling constant evolutions characterized by corresponding hyperbolic cutoff.
2. Preliminary calculations also support the conclusion that for physically sensible values of hyperbolic cutoff for  $k_{max} = 1$  the vanishing conditions can be satisfied for  $k_{max} = 1$  and  $k_{max} = 2$  at the lower end of the interval  $O(k_{max} + n(k_{max}))$  but that already for  $k_{max} = 3$  the conditions fail. The reason is that the value of  $J(k_{max} + n(k_{max}), k_{max} + n(k_{max}) - 1)$  is small and positive and  $1/\alpha_{em}(p, k_{max})$  has positive minimum here so that zero is not possible. In the junction  $J(k_{max} + n(k_{max}) - 1, k_{max} + n(k_{max}) - 2)$   $1/\alpha_{em}(p, k_{max})$  is large and negative and unrealistically large hyperbolic cutoff would be required.

These findings suggest a connection with the p-adic length scale hypothesis. In its strongest form it however cannot help in the problem at hand.

1. In the spirit of criticality one can consider the hypothesis that the p-adic prime in question is as near as possible to the zero junction but below the power of 2 characterizing it. The cutoff momentum would thus correspond to the largest possible one for the curve  $Y(u_{max}, p) = 0$  in the p-adic half octave. In this manner a finite number of scenarios would result since the parameters would be  $n(k_{max})$  and the set of values of hyperbolic cutoff labeled by these primes. For  $n(k_{max} = 1) = 9$  these primes would belong to the upper half of the octave  $[2^8, 2^9]$ . The list of these 25 primes is

367, 373, 379, 383, 389, 397, 401, 409, 419, 421, 431, 433, 439, 443, 449, 457, 461, 463, 467, 479,  
487, 491, 499, 503, 509 .

The problem of this option is that it allow in principle quite large number of alternatives since for each value of  $k_{max}$  branching becomes possible unless one poses additional conditions such as decrease of the hyperbolic cutoff.

2.  $J(k_{max} + n(k_{max}), k_{max} + n(k_{max}) - 1)$  for  $k = 3$  corresponds to a minimum of  $Y = 1/\alpha_{em}(p, k_{max})$  as a function of the hyperbolic cutoff  $u_{max}$ . This inspires a refined hypothesis attaching a genuine physical meaning to the preferred prime  $p(k_{max})$  in accordance with the notion of criticality stating that coupling strength is extremum with respect to some variable, most naturally the parameter  $u_{max}$ . Thus the hyperbolic cutoff for a given  $k_{max}$  would be such that  $Y$  vanishes for  $p(k_{max})$  and is minimum (or possibly maximum) as a function of  $u_{max}$  or momentum  $p$ . The only natural choice is  $u_{max}$ . Thus  $(Y = 0, u_{max}, p)$  could be interpreted as a fixed point of the coupling constant flow with respect to hyperbolic cutoff.
3. The geometric picture would be following. The graph of  $Y$  as a function  $Y(p, u_{max})$  of momentum  $p$  and hyperbolic cutoff  $u_{max}$  is a 2-D surface, and the zeros of  $Y$  define a curve  $X(p, u_{max}) = 0$  as the intersection of  $Y = 0$  plane and the surface  $Y(p, u_{max}) = 0$ . One would have the conditions

$$\begin{aligned}
 Y(p, u_{max}) &= 0 \quad , \\
 \frac{\partial Y}{\partial u_{max}} &= 0 \quad .
 \end{aligned}
 \tag{10.4.2}$$

The constancy of  $Y$  along  $X$  implies the condition

$$\frac{\partial Y}{\partial u_{max}} + \frac{\partial Y}{\partial p} \frac{dp}{du_{max}} = 0 \quad .
 \tag{10.4.3}$$

along the curve  $X$ . Together these conditions imply that the extremum satisfies either of the following conditions

$$\frac{\partial Y}{\partial p} = 0 \quad \text{or} \quad \frac{dp}{du_{max}} = 0 . \quad (10.4.4)$$

In the generic case both partial derivatives can vanish only in a discrete set of points in the space spanned by  $Y, u_{max}$  and  $p$  and the restriction to the plane  $Y = 0$  makes the solution set empty in the generic case. Thus the physically acceptable solutions would correspond to the turning point of the curve  $X$  as  $du/dp$  changes its sign. The cutoff momentum would thus be as near as possible to the upper end of the half octave. In the case that no turning point exists, one can choose the  $u_{max}$  to correspond to the end point of half octave so that the original picture results as a special case.

4. If prime  $p(k_{max})$  as near as possible to the minimum point p-adic length scale hypothesis is realized. The really good (probably too good!) news would be that prime corresponds to the exact minimum. This variational principle fixes coupling constant evolution to a high degree even without the p-adic length scale hypothesis.

Several methods to find the zero of the derivative of  $Y$  with respect to  $u_{max}$  have been tried since the severe restrictions posed by the numerical environment require efficient calculations. The fastest numerical realization for the search of  $u_{max}$  found hitherto is based on the assumption of differentiability. The idea is of course that differentiability allows to extract global information from local information. For instance, interval halving method assumes only continuity and is much slower. Differentiability means  $Y$  can be expanded as Taylor polynomial with respect to  $p$  for a constant value of  $u_{max}$  and vice versa. Repeated use of the numerically estimated first order Taylor polynomial allows to find the zero of both  $Y$  and zero of its partial derivative with respect to  $u_{max}$ .

1. Fix the interval  $O(k_{max} + n(k_{max}))$ . By a guesswork find a value of  $u_{max}$  for which the sign of  $Y$  is different at the end points of the interval. Calculate the derivative of  $Y$  numerically with respect to  $p$  at the lower end of the half-octave and approximating  $Y$  by first order Taylor polynomial estimate the value of  $p$  at which  $Y = 0$  holds true. At this point calculate the derivative of  $Y$  again and repeat the estimate.
2. To find the zero of derivative of  $Y$  with respect to  $u_{max}$  at  $Y = 0$  estimate numerically first and second derivative of  $Y$  with respect to  $u_{max}$  numerically and from the first order Taylor polynomial for the first derivative estimate the value  $u_{max}$  at which the first derivative vanishes.

Note that there is a connection with renormalization group theory. The negative contribution from the pole must compensate the contributions from shorter p-adic length scales, which themselves must cancel to a high degree. Certainly they can do it. The contribution from highest scale would compensate the change of the contributions from shorter scales resulting from change of the p-adic length scale of momentum. The vanishing conditions give kind of renormalization group equation governing the stationary situation and states that the hyperbolic cutoff in scale  $k_{max}$  must be such that its contribution cancels the change of the  $k < k_{max}$  contributions due to the increases of the cutoff momentum. This condition is not not quite all since it only assigns to  $Y = 0$  a definite value of  $p$  but leaves cutoff open. The vanishing of derivative gives additional condition.

### About the results of preliminary calculations

Preliminary calculations carried out up to  $k_{max} = 9$  lead to  $\sinh(\eta_{max})(1) = 0.20600945079286$  and to a value of hyperbolic cutoff which starts to gradually increase at  $k_{max} = 3$  as the table below shows. In the table the label 'cr' refers to the cutoff implied by quantum criticality and 'id' corresponds to the cutoff reproducing the coupling constant evolution.

$k_{max}$	1	2	3	
$cr$	0.20600945079286	0.14741274374679	0.12231921784712	
$id$	0.22050469512552	0.17501469250309	0.15288941641253	
$k_{max}$	4	5	6	
$cr$	0.12717022328504	0.13289051287886	0.13935265256642	(10.4.5)
$id$	0.13890925349465	0.12895192798125	0.12134841022403	
$k_{max}$	7	8	9	
$cr$	0.14687347939079	0.15423164581071	0.16257461579696	
$id$	0.11527058427996	0.11025234756276	0.10600760059852	

The increase can be understood as a positive feedback effect.

1. The calculation predicts  $n(k_{max}) = 9$  for all  $k_{max} \leq 9$  whereas the  $ak^{-b}$  model gives  $k_{max} = 8$  for  $4 \leq k_{max} \leq 7$  and  $k_{max} = 7$  for  $8 \leq 12$ . The problem must relate closely to the sticking to a fixed value of  $k_{max}$ .
2. For a given  $k_{max}$  the contribution from  $k_{max,i} + n(k_{max,i}), k_{max,i} < k_{max}$  to  $Y$  for  $p$  in  $O(k_{max} + n(k_{max}) - 1)$  is positive unless one has  $n_{k_{max}} < n_{k_{max}} - 1$  in which case both values of  $k_{max}$  give negative contributions. Hence the hyperbolic cutoff must increase in order to produce large enough negative contribution.
3. By a judicious choice of  $\sinh(\eta_{max})(k_{max})$  having a discrete set of possible values in one-one correspondence with different values of  $n(k_{max})$ , the feedback effect should become negative and guarantee that  $n(k_{max})$  approaches to unity fast enough. A sufficient reduction of the starting point estimate for  $\sinh(\eta_{max})$  for  $k_{max} \geq 4$  should induce a reduction  $n(k_{max})$  and allow a realistic evolution. Also the initial value  $\sinh(\eta_{max})(1)$  might require changing to a larger or smaller one.

The experimentation by varying the value of  $\sinh(\eta_{max})(1)$  does not give encouraging results. Hyperbolic cutoff begins to increase for all series listed below.

$k$	1	2	3	4
$\sinh(\eta_{max}(k))$	0.09660156250000	0.07527753426130	0.05642313113454	0.058050094309350
	0.13951072443182	0.10638078636486	0.08206464660889	0.08475010008178
	0.16883146306818	0.12598096859481	0.09976082012596	0.10329475255049
	0.20600945079286	0.14741274374679	0.12231921784712	0.13890925349465
	0.25472427728834	0.20217479286468	0.15842711440463	0.17679278339077

(10.4.6)

What could go wrong? These calculations are based on the assumption that the critical momentum is *nearer to the lower end* of the critical half-octave at which  $Y$  changes sign.  $p$  could be however also *nearer to the upper end* of the critical half-octave. The most general option allows both alternatives. If even and odd values of  $k$  correspond to different alternatives, the values of critical momenta are near to each other and  $k_{max}$  contribution must compensate a contribution from shorter scales which is as small as possible since it corresponds to the difference of the critical momenta. This could allow to avoid the increase of  $\sinh(\eta_{max})(k)$ . At the next step the distance between momenta would be however nearly two octaves in the worst case unless the value of  $n_{max}$  is reduced by unity and this could induce to the increase of the cutoff. Only numerical experimentation can tell whether this option works. The experimentation with the option  $\sinh(\eta_{max}(1)) = 0.20600945079286$  yields disappointment. For instance, the value of cutoff can be reduced for  $k_{max} = 4$  but it returns back to the earlier value at  $k_{max} = 5$ .

The increase at small values of  $k_{max}$  need not be a catastrophe as I thought first.

1. The increase of  $u_{max}$  as function of  $k_{max}$  is asymptotic freedom for all bare couplings and this is in accordance with GUT type thinking.
2. As already found, at large values of  $k_{max}$  the calculations show that critical momenta correspond to end points of the half-octaves for  $ak^{-b}$  model so that the decrease of the hyperbolic cutoff conforms with criticality. For instance, for  $a = .20, b = 1/3$  the lower end of the half-octave corresponds to the zero  $X$  in the range  $k_{max} = 89, \dots, 91$  (I have not checked how long interval gives the same result).
3. If the value of hyperbolic cutoff is small enough for  $k_{max} = 1$ , it could increase for small values of  $k_{max}$  and start to decrease for some value of  $k_{max} < 89$ . Since the behavior at long length scales reflects only the net contribution from short length scales, it might be possible to obtain consistency with the values of fine structure constant at electron and intermediate boson length scales. Unfortunately the numerical calculations are very slow with the computer resources available so that it takes time to check this.

The calculations done for the option  $\sinh(\eta_{max}(1)) = 0.09660156250000$  up to  $k_{max} = 29$  are not encouraging in this respect.

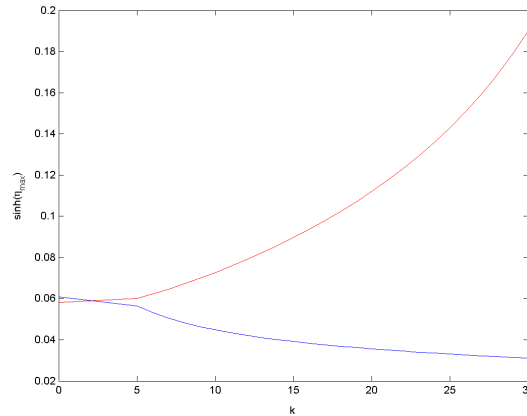

Figure 10.7: The hyperbolic cutoff  $\sinh(\eta_{max}(k))$  for the model of criticality with  $\sinh(\eta_{max}(1)) = 0.09660156250000$  assuming that critical momentum corresponds to the vanishing of both  $1/\alpha_{em}$  and  $\partial_{u_{max}} 1/\alpha_{em}$  so that critical momentum as near as possible to an end point of half octave.

The growth of the hyperbolic cutoff is in good approximation exponential with a slowly increasing rate parameter  $r$ . At certain value of  $r$  starts to increase rapidly as the figure 10.4.2 demonstrates. This kind of behavior is definitely non-physical.

Could one consider any cure to the situation? As already noticed, the relationship between the time-like and space-like hyperbolic cutoffs forced by the cancelation of the radiative mass is number theoretically cumbersome, and it might be that super-conformal symmetry or some more general symmetry could guarantee the cancelation of the radiative mass just as space-time super-symmetry does this in SUSYs [?]. This would allow the time-like and space-like cutoffs to be identical and affect considerably the loop corrections since space-like corrections would dominate and one would expect behavior of the hyperbolic cutoff to be roughly  $a/k$  rather than  $ak^{-1/3}$ . At this moment it is not possible to do any quantitative calculations in this respect without making simplifying ad hoc assumptions.

### 10.4.3 Could p-adic fractality solve the problems?

The above described proposals for how quantum criticality could fix coupling constant evolution in a manner consistent with  $ak^{-b}$  model might fail. The fundamental observation is that critical momenta



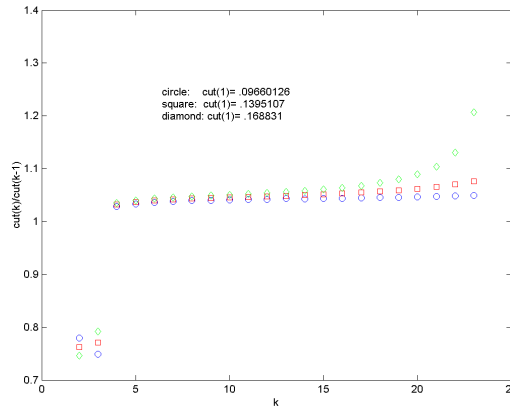

Figure 10.8: The ratio  $r = cut(k + 1)/cut(k)$  for the hyperbolic cutoff  $cut(k) \equiv \sinh(\eta_{max}(k))$  as function of  $k$  for three values of  $cut(1)$  is in reasonable approximation constant so that  $cut(k)$  increases exponentially. For certain critical value  $r$  begins to increase rapidly.

correspond to an end point of the half octave for large values of  $k$  automatically and  $2^k$ -adic behavior and discontinuities at the end point of the half octave emerges naturally at this limit. The obvious question is whether and how could one generalize this behavior. Superconformal invariance and some more general symmetry has been already mentioned. Or should one perhaps replace the inverse propagator with p-adic fractal to obtain discontinuities or perhaps even zeros at the end points of half-octaves for all values of  $k_{max}$ ? p-Adic thermodynamics in which mass squared and probabilities are p-adic valued and mapped to their real counterparts by canonical identification [?, ?] indeed suggests an approach based on p-adic fractalization. One can imagine several variants of this fractalization.

1. One could replace inverse propagator as a function of mass squared with its p-adic fractal variant obtained by the fractalization procedure meaning the replacement of  $p^2$  (mass squared) with its  $2^k$ -adic variant in the argument of  $1/\alpha_{em}(k_{max})$ , the replacement of ordinary algebraic operations with their  $2^k$ -adic or p-adic counterparts and the mapping of the resulting p-adic valued function back to the reals by the inverse of the canonical identification. The proposed model yielding the real propagator would remain an exact part of the model. The problem is that p-adicization respects the zeros of function so that the zeros of  $1/\alpha_{em}(k_{max})$  would not be shifted to the end points of half-octaves.
2. The loop integral for a given half octave  $O(k)$ ,  $1 \leq k \leq k_{max}$ , is the basic building block of  $1/\alpha_{em}(k_{max})$ . This suggests that it is these contributions which are  $2^k$ -adicized or p-adicized for  $p \simeq 2^k$ . The sum over these contributions carried out using  $2^k$ - or p-adic arithmetics would bring in the fractality. This would make possible to shift the zeros near the end points of the half octave with a proper choice of hyperbolic cutoff or even the replacement of zeros by discontinuous change of sign. If the detailed fractalization recipe is such that for large values of  $2^k$  or  $p$  real topology results in a good approximation, a consistency  $2^k$ -adic fractality suggested near cutoff mass also by the number based real approach for large values of  $k_{max}$  is obtained.
3. One could also consider the option in which one performs p-adic fractalization for the integrand appearing in the loop integral. This option however means quite a dramatic departure from the original model. For instance, the relationship between time-like and space-like hyperbolic cutoffs are lost guaranteeing masslessness would be lost. Also the definition of the p-adic variant of the momentum space represents a non-trivial challenges and one should treat mass squared and hyperbolic angle and other angles in non-symmetric manner in order to avoid the loss of Lorentz invariance. If all these coordinates are p-adicized there is algebraic interaction between all of them and hopes about reasonably simple numerics are lost. Already these reasons are enough to not consider this option. A further generalization would be the replacement of the

real loop integral by its possibly existing p-adic variant but the non-existence of satisfactory definition of p-adic definite integral is discouraging.

### The general recipe for p-adic fractalization

p-Adic fractals are obtained by replacing real analytic function  $f_R(x)$  with integer valued coefficients with its p-adic variant  $f_p(x)$ . One maps first the argument  $x_R$  to its p-adic variant  $x_p$  by the inverse  $I^{-1}$  of the canonical identification, calculates  $f(x_p)$  interpreted now as p-adically analytic function, and then maps the  $f(x_p)$  to a real number  $(f(x_p))_R$  by  $I$ . Since  $I$  does not commute with arithmetic operations, one obtains a fractal which has typically discontinuities at powers of  $p$ . By suitably generalizing the notion of canonical identification one can consider also functions for which the coefficients of Laurent series are rational numbers. Allowing algebraic extensions of p-adic numbers one can consider also algebraic coefficients.

Canonical identification allows several variants.

1. The simplest variant of a p-adic fractal is obtained by using the rule  $\sum x_n p^n \rightarrow f_p(x) = \sum x_n p^{-n}$  to map p-adic numbers to their real counterparts in a continuous manner. The inverse of the canonical identification is unique for numbers of form  $2^k n$ ,  $n$  a finite integer. If  $n$  is p-adic integer infinite as a real integer the inverse image of its image is two-valued. This corresponds to the fact that the binary expansion for real numbers is not unique when the number of binary digits is infinite (for instance  $-1 = (p-1)(1+p+p^2\dots)$  and  $1/p$  are mapped to same real point  $p$  in canonical identification).
2. Canonical identification is continuous but does not commute with the basic arithmetic operations since in general one has  $(x+y)_R \neq x_R + y_R$  and  $(xy)_R \neq x_R y_R$ . For integers smaller enough than  $p$  one has however commutativity so that addition and multiplication and also subtraction if it does not produce negative number commute in approximate sense with  $I$ .
3. One can consider also a canonical identification based on writing 2-adic expansion in the form  $x = \sum x_n p^{nk}$ ,  $x_n = \sum_0^{k-1} y_{nr} p^r$ . This map maps all integers smaller than  $p^k$  to itself. One might speak of  $p^k$ -adic fractal in this case. Effective p-adic topology could be interpreted in terms of  $2^k$ -adic fractality since  $2^k$ -adic thermodynamics and p-adic thermodynamics for  $p \simeq 2^k$  give very similar predictions for particle masses. p-Adic length scale  $k$  could correspond to the canonical identification labeled by  $k$  and at long length scales ordinary topology would gradually establish itself.
4. The problem of the simplest variants of canonical identification is that they do not respect even approximately real division: except in special cases  $I(m/n)$  does not have much to do with  $I(m)/I(n)$  if one expresses  $m/n$  as an infinite series in powers of  $p$  as is always possible. Physically  $I(m/n) \simeq I(m)/I(n)$  property would be however desirable approximately at least. The modification of the canonical identification respecting this property is based on the unique representation of the rational number as  $q = m/n$  ( $m$  and  $n$  have no common factors) and the definition of the canonical identification as  $q \rightarrow I(m)/I(n)$ . Here also  $p^k$ -adic variant of  $I$  could be used so that rationals with  $m < p^k, n < p^k$  would be mapped to rationals. In this manner canonical identification could be generalized to functions  $f(x)$  for which Laurent series has rational valued coefficients. Also algebraic coefficients are possible if algebraic extensions of p-adics are allowed.
5. The arithmetic operations on p-adic side - sums in the recent case - should be performed in such a manner that the outcome is a rational number mapped to real side by the inverse of the variant of canonical identification used. This is possible in a unique manner if binary cutoff for the expansions in powers of  $p$  is introduced. Also the fact that infinite series in powers of  $p$  appear makes binary cutoff necessary. The sum of the contributions from different p-adic half-octaves would reduce to sums of rationals and could be carried out in standard manner by forming a common denominator as a product of denominators. The representation as a generalized rational in which  $m$  and  $n$  are p-adic integers infinite as real integers is not unique since  $m/n$  can be always represented as an infinite integer when  $n$  is not divisible by  $p$ . The recipe for forming sums of rationals by forming common denominator would formally work but in practice binary cutoff is unavoidable in any case.

6. A conceptual problem related to the canonical identification is that it is not general coordinate invariant concept so that one encounters potential problems with symmetries. In the recent case however only mass squared defines a unique coordinate as Lorentz invariant and one circumvents this kind of problems.
7. Canonical identification maps all p-adic numbers to non-negative ones and minus sign has no natural p-adic counterpart so that p-adic fractalization of functions having also negative values requires a special care.
  - (a) The first problem is that it is not clear how to map negative real numbers to their p-adic counterparts. In the recent case however absolute value of  $p^2$  appears as the argument of the propagator so that this is not a problem. If one just takes the real analytic function with rational Laurent series and interprets it as its p-adic variant, canonical identification gives always a non-negative real function. For the inverse of the propagator one does not encounter this problem for physical values of  $p$  since non-negativity dictates the cutoff momentum. On the other hand, p-adicization would yield a non-negative value of  $1/\alpha_{em}$  everywhere and one could consider the possibility that this could be the deeper reason why for the p-adic fractalization. p-Adic fractalization might take place also in the confinement phase transition in which the coupling strength becomes negative in QFT based on real topology for mass squared.
  - (b) One could also separate the sign of real function by decomposing the domain of definition to regions in which the function has definite sign. The absolute value of the function could be mapped to its p-adic counterpart and mapped back by canonical identification in this approach. This kind of separation of sign factor is carried out also in Lebesgue integral.
8. Imaginary unit is also a potential problem, which is however absent if the physically unavoidable momentum cutoff eliminating pole contribution to the propagator is posed. For  $p \bmod 4 = 3$  imaginary unit can be introduced via an algebraic extension and it is natural to map real imaginary unit to its p-adic counterpart in this case. For  $p \bmod 4 = 1$   $\sqrt{-1}$  however exists as a p-adic number and the real image of the p-adicized complex function is real function in this case so that it seems that one must pose the condition  $p \bmod 4 = 3$  or treat the real imaginary unit just like minus sign.

### p-Adic fractalization of propagator

The first rough sketch for the criticality realized in terms of p-adic fractalization would be as follows.

1. One begins from the analytic expression for the contribution from the half-octave  $k \leq k_{max}$ , maps momentum  $p$  to p-adic number by  $I^{-1}$ , replaces the contribution with its p-adic variant, performs the p-adic summation of the contributions with various values of  $k$  and maps the result to reals by  $I$ . For a given value of  $k_{max}$   $2^{k_{max}+n(k_{max})}$ -adic fractalization based on  $I(m/n) = I(m)/I(n)$  takes place. Alternatively, p-adic fractalization with  $p \simeq 2^{k_{max}+n(k_{max})}$  is carried out.
2. Hyperbolic cutoff as a function of  $k_{max}$  is required to be such that the cutoff momentum  $p$  is at the either end of the half-octave. Stronger condition would be that  $1/\alpha_{em}$  vanishes at the end of the interval.
3. As far as numerics is considered, the new element is the replacement of the analytic representation of the loop integral for given value of  $k$  with its p-adic variant. This representation exists with certain restrictions on the values of  $p/m_k$ .
  - (a) Integrals of rational functions with integer coefficients are in question and give rational functions and logarithms. In the case of logarithms problems are encountered unless one can reduce everything these functions to  $\log(1+x)$  existing p-adically for  $|x|_p < 1$ . One must of course introduce  $\log(2)$  since the asymptotic contribution is proportional to  $\log(2)$ . Also  $\pi$  must be introduced the extension of p-adic numbers infinite-dimensional in the algebraic sense. These restrictions might well force the p-adic momentum cutoff number theoretically.

- (b) The inspection of the formulas for the integrals involved shows that for momenta in the region where one cannot expand the logarithms of integrands as power series the logarithms make the situation very complex. This provides number theoretic justification for the introduction of the cutoff of loop momenta larger than the virtual mass of gauge boson. It also eliminates the non-physical imaginary pole contribution and one gets rid of the problems posed by the negative values of the propagator.
- (c) In the asymptotic region where  $x_{k,r} = 2^{-r} \times (p/m(k_{max}))$ ,  $r \in \{1/2, 1\}$  ( $p$  denotes mass here) is small both in real and p-adic sense, the situation is relatively simple.  $p^2$  is indeed of order  $O(p)$  or  $O(2^{k_{max}+n_{k_{max}}})$  p-adically so that this condition is satisfied. If powers of  $u_{max}$  and  $x_{k,r}$  exist p-adically, various rational integrals exist p-adically. Also  $\log(u_{max})$  must make sense p-adically and  $u_{max} = 1 + O(p)$  is the minimal requirement guaranteeing this. At least  $\sqrt{2}$ ,  $\log(2)$ , and  $\pi$  must belong to the extension of p-adic numbers used. For a genuinely p-adic topology the cutoff hierarchy depends on p-adic prime  $p$  but for  $2^k$ -adic case cutoff hierarchy is same for all values of  $k$  so that  $2^k$ -adicity looks a more appropriate option.
4. The basic challenge is the summation of the contributions from different value of  $k_{max}$ . For suitably chosen cutoffs this might be possible to carry out analytically and the condition that this is possible might be part of quantum criticality. The condition that the contribution is a function of  $p/m_k$  with rational or at most algebraic coefficients is expected to pose strong conditions on the form of the hyperbolic cutoff as function of  $k_{max}$ .

#### p-Adic fractalization of the entire perturbation theory?

p-Adic fractalization works also for the vertices and would mean the mapping of the various contributions to the n-point function to their p-adic counterparts, performing the summation, and mapping the result back to the reals by  $I$ . If all contributions depend on Lorentz invariants such as  $s_{ij} = (p_i - p_j)^2$  and  $\epsilon_i \cdot p_j$ , p-adic fractalization can be carried out in Lorentz invariant manner. The invariant mass squared  $s_U$  for any subset  $U$  of particles defines this kind of invariant and  $s_U$  is same for a subset and its complement so that for  $N_i \rightarrow N_f$  scattering there are  $2^{N_i+N_f-1}$  invariants of this kind. The set of these invariants and thus canonical identification is unique. The entire perturbation series for the coefficients of Lorentz invariant form factors could be replaced with its p-adic variant with summation over various contributions carried out using p-adic arithmetics. Unless one treats separately the minus sign and imaginary unit, the resulting amplitudes would be non-negative numbers and interference effects would occur at the p-adic level only.

There is an objection against this picture. One can speak about interference in real and p-adic sense. How does one know which sums appearing in perturbation theory are carried out at the real side and which sums are performed at the p-adic side? An illustrative example is  $F \rightarrow BF \rightarrow F$  loop diagram contributing to the fermion propagator. The integral must be carried at the real side. What bosonic propagator should one use? The real propagator or its p-adic fractal variant? If p-adic fractal variant is used, a problem is caused by the fact that it does not have any nice analytic expression and the effect of canonical identification is not on an analytic function. Hence it would seem that one must calculate the basic building blocks  $n$ :th order contribution at the real side and then p-adicize. Hence p-adicization would be applied to the bosonic propagator itself rather than to the contributions from different p-adic length scales and one would lose the original motivation for the p-adic fractality.

Loops are also the basic problem of the twistor approach since the particles in the loops are massive and twistorialization for them is not elegant. The unitarization using Cutkosky rules meaning the addition of  $TT^\dagger$  term to the tree amplitude however allows twistorialization since loops are avoided completely and only light-like momenta are involved. This procedure could be used also to perform p-adicization and p-adic fractalization. Fermionic loops giving the vertices could be calculated in the real context and continued to the p-adic side. p-Adicization works for T-matrix if  $TT^\dagger$  allows it. The same procedure would make possible twistorialization, p-adicization, and p-adic fractalization.

A more radical possibility is that the loops associated with the  $T$ -matrix vanish if the incoming and outgoing particles are on mass shell so that only tree diagrams contribute to  $T$ -matrix. The interpretation would be in terms of quantum criticality. Also in this case one must however include  $TT^\dagger$  contribution to guarantee unitarity since the cutoff on loop momenta implies that the corresponding

contribution to the discontinuity of  $T$  vanishes. Therefore this approach seems un-necessarily complicated and leads to conditions which are very probably too strong. The vanishing of the N-vertices defined by fermionic loops for on mass shell bosons however makes sense and could be interpreted as a precise quantitative realization of quantum quantum criticality and bosonic emergence. This condition has also generalization to massive case and also to full quantum TGD. In the following both these options are discussed in more detail.

**What about unitarity?**

One criticism of the proposed vision is that the realization of unitarity in terms of Cutkosky rules do not seem to be consistent with the cutoff for loop momenta. In the following various options for defining unitary S-matrix are considered.

1. *Feynman graphics for zero energy states*

1. In negative energy ontology standard view about Feynman graphics can be expressed as the rule

$$T^{+-} = T^{+-} \hat{\times} T^{+-} . \tag{10.4.7}$$

Here  $\hat{\times}$  is product involving sum over virtual momenta restricted only by the p-adic cutoffs on mass squared and hyperbolic angle. There is analogy with projection operator for the extended product  $\hat{\times}$  but with incoming and outgoing momenta restricted to on mass shell.

2. Cutkosky rules can be expressed as

$$Disc(T^{+-}) = T^{+-} T^{+-} , \tag{10.4.8}$$

where the latter product is over on mass shell states with a given particle number in the intermediate state. Cutkosky rules imply that unitarity does not depend on the values of coupling constants and is much stronger condition than mere unitarity. Quantum criticality however requires special values of coupling constants so that either Cutkosky rules fail or some additional conditions emerge.

3. The application of Cutkosky rules to the above expression however yields a cold shower since the p-adic cutoffs for the loop momenta imply that the discontinuity vanishes. The only manner to guarantee unitarity is by adding the  $TT^\dagger$  contribution from massless intermediate states by hand as is done in the unitarization of twistor diagrams. This in turn make it un-necessary to introduce other than on mass shell loops and the original idea that loop momenta are light-like [?] is realized. This method also allow p-adicization and p-adic fractalization if  $TT^\dagger$  contribution makes sense p-adically. Sceptic reader can of course wonder why p-adic effective topology in momentum space would be needed. For p-adic mass calculations the answer is clear but for T-matrix far from so.

4. The p-adic fractal variant  $T_p$  of real  $T$ -matrix satisfies unitarity conditions in standard form only if the condition

$$(TT^\dagger)_p = T_p T_p^\dagger \tag{10.4.9}$$

holds true. The simplest possible toy example about the conditions is the product of two p-adic integers  $x = \sum x_n p^n$  and  $y = \sum y_n p^n$ .  $x_p y_p = (xy)_p$  for the simplest form of canonical identification only if the conditions  $\sum_{m \leq n} x_{n-m} y_m < p$  holds true. It could be possible to satisfy unitarity conditions with a suitable cutoff for pinary digits for the canonical identification used, at least in the measurement resolution used.

5. Could also fermionic loops be defined in terms of Cutkosky rules? If so, one could not introduce cutoffs and could not understand coupling constant evolution in the proposed manner. There is also another objection against this picture. In the case of massless particles the rate  $r(B \rightarrow FF)$  in which all momenta are collinear would define the absorptive part whose continuation would define the inverse of the bosonic propagator but only at mass shell where the propagator vanishes. This would mean the vanishing of  $r$  which might make sense due to the extremely singular kinematics. Hence this approach fails.
6. The vanishing of N-vertices for on mass shell momenta of incoming bosons would however be a natural condition fixing the hyperbolic cutoff since otherwise one should add unitarizing contribution and would not have a genuine vertex anymore. The vanishing of all vertices except  $BFF$  vertex on mass shell would also conform with the fact that Dirac action defines the entire theory. One testable implication of the vanishing condition is the prediction that the box diagram for  $2 \rightarrow 2$  scattering of gauge bosons vanishes and the scattering amplitude corresponds to the absorptive contribution to the annihilation of two gauge bosons to two fermion and antifermion.
7. Furry's theorem states that fermionic loops vanish for odd number of external photons irrespective of whether they are on or off mass shell. Furry's theorem follows from the oddness of the photon under charge conjugation implying that vacuum expectation involving odd number of photon fields vanishes. At the Feynman diagram level the theorem follows from the formulas  $C\gamma^\mu C^{-1} = -\gamma^\mu$  and  $CD_F(x_1, x_2)C^{-1} = D_F(x_2, x_1)$  allowing to show that diagrams with different orientation of fermionic lines contribute with opposite signs for a odd number of external photons (there is sum over the diagrams obtained by the permutation of vertices along the loop with one vertex fixed). Furry's theorem does not hold true for fermionic loops involving odd number of non-Abelian gluons since the permutation of boson vertices involves also permutation of charge matrices and vanishing occurs only if  $Tr(T_{a_1}T_{a_2}\dots T_{a_n}) = Tr(T_{a_n}T_{a_{n-1}}\dots T_{a_1})$  holds true.
8. If the N-vertex reduces to a sum of terms for which at least one of boson legs, - say the  $i^{th}$  one is proportional to  $p_i^\mu$ , vanishing occurs when all bosons are on mass shell. Non-abelian gauge boson vertices do not vanish on mass shell so that a form factor guaranteeing the vanishing of this kind of vertices must be present and should be induced by dynamical symmetries of some kind implying that the on mass shell bosonic action effectively reduces to that of a free Abelian YM theory.
9. One can hope that the hyperbolic cutoff alone could guarantee this miracle.  $p_i^2 = 0$  limit corresponds to asymptotia as far as the hyperbolic cutoff as a function of the p-adic mass scale labeled by  $k$  is considered. The weak form of the condition would state that the vanishing takes place only at the limit when the IR cutoff for the loop mass scale approaches zero - that is at the limit  $k_{max} \rightarrow \infty$ . The contributions from various p-adic mass scales would sum up to zero at this limit for any N-vertex. The resulting infinite set of conditions could fix hyperbolic cutoff as a function of  $k$ . The fact that the loops involve both gluons and electro-weak gauge bosons strengthens the conditions further.

The form of the condition consistent with finite measurement resolution would state that on mass shell  $N$ -vertices vanish for any value of  $k_{max}$  up to some maximum value  $N_{cr}$  depending on  $k_{max}$ .  $N_{cr}(k_{max})$  would be analogous to the order of perturbation theory and correspond to the maximal number of internal propagator legs. It would also characterize the measurement resolution.

### What could be the role of super-conformal and more general symmetries?

The argument, which eventually led to p-adic fractality and vanishing of loops as a realization of quantum criticality started from the working hypothesis that  $1/\alpha_{em}$  vanishes at a point which is as near to either end of the p-adic half octave as possible. This ad hoc assumption might be wrong and must be replaced with much more general assumption that vertices vanish for on mass shell gauge bosons. The cancelation of the vertices should be based on some general mechanism. Hyperbolic cutoff is the possibility already considered but symmetries is what would be the first guess in the framework of standard QFT.

1. *Is it necessary to have different hyperbolic cutoffs for time-like and space-like momenta?*

In the proposed model for the hyperbolic cutoff the cancelation of the mass term in the bosonic propagator fixes the relationship between time-like and space-like hyperbolic cutoffs. This approach did not predict a realistic evolution of the hyperbolic cutoff in the purely real context. One could hope that p-adic fractalization could help to resolve the problem.

The question is whether mere dynamical gauge symmetry could guarantee the vanishing of the vertices when incoming bosons are massless and have physical polarizations so that loop contributions would involve  $p_i^2$  and  $\epsilon_i \cdot p_i$  factors. If the vanishing for on mass shell momenta were implied by symmetries and would not occur for off mass shell particles, hyperbolic cutoff would become unnecessary and one could have the picture of standard quantum field theory. Also the fermionic loop defining the inverse of the gauge boson propagator should cancel for  $p^2 = 0$  as it indeed does by its  $p^2$ -proportionality.

Dynamical super-conformal or gauge invariance should force the vertices to be proportional to the product  $f \prod_i (p_i^2)$  with  $f(p_i^2) = 0$ , where  $p_i$  are the momenta for the incoming and outgoing particles. Vertices other than  $BFF$  would be non-vanishing only if some bosons are off mass shell. If this kind of vertices are to mimic the vertices of YM theory, they should be slowly varying: for instance,  $\prod_i (1/\log(p_i^2/M^2))$  proportionality of N-vertices would give hopes about this kind of mimicry. Maybe massless quarks and gluons inside hadrons are effectively non-interacting because vertices vanish for on mass shell massless particles whereas massivation for the electro-weak gauge bosons by symmetry breaking would make electro-weak vertices non-trivial.

2. *Superconformal invariance replaces space-time supersymmetry in TGD framework*

1. One of the most beautiful predictions of SUSY gauge theories [?] is the cancelation of the leading order corrections to the mass of the scalar particle whereas logarithmic corrections do not vanish and could be finite in  $N = 4$  SUSY.
2. In TGD framework there are reasons to believe that space-time supersymmetry is replaced by super-conformal symmetry so that sparticles are not quite what they are in SUSY gauge theories. Sparticles would be obtained by adding to the state a right handed neutrino moving in a non-trivial color partial wave so that sparticles in the sense of the minimal supersymmetry standard model (MSSM [?]) would not be present. There would be an infinite tower of these colored excitations. In fact, the allowed parameter space for MSSM has been shrinking continually [?] and challenges MSSM as a generalization of the standard model.
3. The notion of finite measurement resolution realized in terms of inclusions of hyperfinite factors of type  $II_1$  [K82, K25] leads to the proposal that there is infinite hierarchy of dynamical gauge symmetries and that the super-conformal variants of these symmetries could act as Super Kac-Moody type dynamical symmetries and leave physical states invariant.

3. *Could dynamical symmetries make possible non-trivial bosonic vertices vanishing for on mass shell momenta?*

The question is whether super-conformal sfermions associated with some dynamical gauge symmetry possibly related to the finite measurement resolution and HFFs could allow non-trivial bosonic vertices vanishing for on mass shell momenta.

1. There should be a force binding right handed neutrino and fermion together. This would suggest that right handed neutrino and fermion are colored and the force acts between wormhole throats which corresponds to a deformation of  $CP_2$  type vacuum extremal possessing induced metric with Euclidian signature. Since the addition of a possibly colored right handed neutrino would transform particle to sparticle in TGD, sfermions in TGD framework are not what they are in SUSYs. Squarks would be leptoquarks containing right-handed neutrino and sleptons would involve a contraction of  $M^4$  or  $CP_2$  gamma matrices with some naturally occurring classical vector field. Candidates for this kind of vector fields emerge in the formulation based on modified Dirac action.
2. Unless one is ready to modify the original idea about bosonic emergence, the only logical manner to define the propagator associated with the bosonic super partners of the fermion is in terms of a

fermionic loop in which the vertex contains a projector to the right handed neutrino spinor and a matrix responsible for the spin structure of the state at imbedding space level. The contribution to the gauge boson propagator from these states is higher order loop contribution and should vanish at  $p^2 = 0$  limit by the general vision. Hence the introduction of super partners would not help to get rid of the radiatively generated gauge boson mass. Note that this definition of sfermion propagators treats super-partners differently and is therefore inconsistent with the notion of super symmetry. Dynamical and probably broken super-conformal symmetry could be in question.

3. One can imagine also sfermions for which fermion and right handed neutrino reside at the same wormhole throat rather than opposite wormhole throats. Also now color force could guarantee stability of the state so that colored super-conformal generators with quantum numbers of right handed neutrino would be involved as also colored fermions. In this case one could argue that the propagator is just a scalar or vector propagator at the fundamental level. Note however that gauge invariance might cause difficulties if vectorial super-partners are allowed. If the coupling of the gauge boson to the sfermion candidates boils down to the standard coupling of a gauge boson to a scalar field, one obtains  $A \cdot p$  and  $A \cdot A$  couplings for scalar super partner and only the first one contributes to the gauge boson propagator. The contribution is automatically proportional to  $p^2$  for scalar superpartner and presumably also for spin one super-partners. Since no contribution to gauge boson mass appears, the relation between the time-like and hyperbolic cutoffs would remain the only possible manner to guarantee the vanishing of gauge boson mass and hyperbolic cutoff would be indeed fundamental for the understanding also the dynamical symmetry guaranteing the cancelation of loops.
4. Somewhat disappointingly, it would seem that the contribution of the superpartners to the inverse of the propagator can affect only the evolution of the hyperbolic cutoff if determined by the condition that critical momenta for which  $1/\alpha_{em}$  vanishes are as near as possible to the end points of the half octave, and one might hope a physically sensible prediction for the coupling constant evolution. What would be needed would be the transformation of the positive feedback loop to a negative one so that hyperbolic cutoff could decrease. Sfermion couplings should transform the increase of the coupling constant strength as a function of p-adic length scale characteristic for asymptotic freedom to a decrease.

To sum up: quantum criticality, bosonic emergence, number theoretic universality, p-adic fractality, and twistor program seem to be very intimately inter-related in TGD Universe. Less clear is whether dynamical super-conformal symmetries related to finite measurement resolution and hierarchy of HFFs are involved. Needless to say, the overall situation is far from crystal clear at this moment. The great question marks are whether the hyperbolic cutoff could be avoided by symmetries and if not - whether the choice of hyperbolic cutoff is fixed by the condition that N-vertices vanish at the limit when bosons are massless and IR cutoff for loop mass scale is taken to zero. Recall that the argument, which eventually led to p-adic fractality and vanishing of loops as a realization of quantum criticality started from the working hypothesis that  $1/\alpha_{em}$  vanishes at a point which is as near to either end of the p-adic half octave as possible. This somewhat ad hoc assumption can be replaced with much more general assumption that the fermionic loops defining the vertices vanish for on mass shell bosons.

## 10.5 Further progress

### 10.5.1 Could supersymmetry make momentum cutoffs un-necessary?

Super symmetric QFTs (SUSYs) are much more well-behaved than ordinary gauge theories as far as divergences are considered. This raises the question whether supersymmetry could allow to get rid of the momentum cutoffs in the loop integrations defining the bosonic propagators.

Contrary to the original expectations, TGD seems to allow a generalization of the space-time supersymmetry. This became clear with the increased understanding of the modified Dirac action [K15, ?]. The introduction of a measurement interaction term to the action allows to understand how stringy propagator results and provides profound insights about physics predicted by TGD. Also an old anomalous particle production event [?] that I learned of in the blog of Tommaso Dorigo [?] having



interpretation in terms of super-symmetry forced to reconsider the possibility of space-time super-symmetry in TGD [K43] .

The appearance of the momentum and color quantum numbers in the measurement interaction couples space-time degrees of freedom to quantum numbers and allows also to define SUSY algebra at fundamental level as anti-commutation relations of fermionic oscillator operators. Depending on the situation  $\mathcal{N} = 2N$  SUSY algebra or fermionic part of super-conformal algebra with infinite number of oscillator operators results. The addition of fermion in particular mode would define particular super-symmetry. Zero energy ontology implies that fermions as wormhole throats correspond to chiral super-fields assignable to positive or negative energy SUSY algebra whereas bosons as wormhole contacts with two throats correspond to the direct sum of positive and negative energy algebra and to fields which are chiral or antichiral with respect to both positive and negative energy theta parameters. This super-symmetry is badly broken due to the dynamics of the modified Dirac operator which also mixes  $M^4$  chiralities inducing massivation. Since righthanded neutrino has no electro-weak couplings the breaking of the corresponding super-symmetry should be weakest.

The question is whether this SUSY has a realization as a SUSY algebra at space-time level and whether the QFT limit of TGD could be formulated as a generalization of SUSY QFT. There are several problems involved.

1. In TGD framework super-symmetry means addition of fermion to the state and since the number of spinor modes is larger states with large spin and fermion numbers are obtained. This picture does not fit to the standard view about super-symmetry. In particular, the identification of theta parameters as Majorana spinors and super-charges as Hermitian operators is not possible.
2. The belief that Majorana spinors are somehow an intrinsic aspect of super-symmetry is however only a belief. Weyl spinors meaning complex theta parameters are also possible. Theta parameters can also carry fermion number meaning only the supercharges carry fermion number and are non-hermitian. The the general classification of super-symmetric theories indeed demonstrates that for  $D = 8$  Weyl spinors and complex and non-hermitian super-charges are possible. The original motivation for Majorana spinors might come from MSSM assuming that right handed neutrino does not exist. This belief might have also led to string theories in  $D=10$  and  $D=11$  as the only possible candidates for TOE after it turned out that chiral anomalies cancel.
3. The massivation of particles is the basic problem of both SUSYs and twistor approach. The fact that particles which are massive in  $M^4$  sense can be interpreted as massless particles in  $M^4 \times CP_2$  suggests a manner to understand super-symmetry breaking and massivation in TGD framework. In particular, the massive particle can be put in short representations of SUSY even when the massivation is by p-adic thermodynamics. The octonionic realization of twistors is a very attractive possibility in this framework and quaternionicity condition guaranteeing associativity leads to twistors which are almost equivalent with ordinary 4-D twistors.

It seems possible to formulate even quantum TGD proper in terms of super-field defined in the world of classical worlds (WCW). Super-fields would provide in this framework an elegant book-keeping apparatus for the elements of local Clifford algebra of WCW extended to fields in the  $M^4 \times CP_2$  whose points label the positions of the tips of the causal diamonds ( $CDs$ ). What the actual construction of SUSY QFT limit means depends on how strong approximations one wants to make.

1. The minimal approach to SUSY QFT limit is based on an approximation assuming only the super-multiplets generated by right-handed neutrino or both right-handed neutrino and its antineutrino. The assumption that right-handed neutrino has fermion number opposite to that of the fermion associated with the wormhole throat implies that bosons correspond to  $\mathcal{N} = (1, 1)$  SUSY and fermions to  $\mathcal{N} = 1$  SUSY identifiable also as a short representation of  $\mathcal{N} = (1, 1)$  SUSY algebra trivial with respect to positive or negative energy algebra. This means a deviation from the standard view but the standard SUSY gauge theory formalism seems to apply in this case.
2. A more ambitious approach would put the modes of induced spinor fields up to some cutoff into super-multiplets. At the level next to the one described above the lowest modes of the induced spinor fields would be included. The very large value of  $\mathcal{N}$  means that  $\mathcal{N} \leq \exists \in$  SUSY cannot define the QFT limit of TGD for higher cutoffs. One should generalize SUSYs gauge theories to

arbitrary value of  $\mathcal{N}$  but there are reasons to expect that the formalism becomes rather complex. More ambitious approach working at TGD however suggest a more general manner to avoid this problem.

- (a) One of the key predictions of TGD is that gauge bosons and Higgs can be regarded as bound states of fermion and antifermion located at opposite throats of a wormhole contact. This implies bosonic emergence meaning that its QFT limit can be defined in terms of Dirac action. Bosonic propagators and vertices can be constructed as fermionic loops so that all coupling constants follow as predictions. One must however pose cutoffs in mass squared and hyperbolic angle assignable to the momenta of fermions appearing in the loops in order to obtain finite theory and to avoid massivation of bosons. The resulting coupling constant evolution is consistent with low energy phenomenology if the cutoffs in hyperbolic angle as a function of p-adic length scale is chosen suitably.
  - (b) The generalization of bosonic emergence that the TGD counterpart of SUSY is obtained by the replacement of Dirac action with action for chiral super-field coupled to vector field as the action defining the theory so that the propagators of bosons and all their super-counterparts would emerge as fermionic loops.
  - (c) The huge super-symmetries give excellent hopes about the cancelation of infinities so that this approach would work even without the cutoffs in mass squared and hyperbolic angle assignable to the momenta of fermions appearing in the loops. Cutoffs have a physical motivation in zero energy ontology but it could be an excellent approximation to take them to infinity. Alternatively, super-symmetric dynamics provides cutoffs dynamically.
3. The intriguing formal analogy of the Kähler potential and super-potential with the Kähler function defining the Kähler metric of WCW and determined up to a real part of analytic function of the complex coordinates of WCW. This analogy suggests that the action defining the SUSY-Kähler potential- is identifiable as the Kähler function defining WCW Kähler metric at its maximum. Super-potential in turn would correspond to a holomorphic function defining the modification of Kähler function due and the space-time sheet due to measurement interaction. This beautiful correspondence would make WCW geometry directly visible in the properties of QFT limit of TGD.
  4. The condition that  $\mathcal{N} = \infty$  variants for chiral and vector superfields exist fixes completely the identification of these fields in zero energy ontology.
    - (a) In this framework chiral fields are generalizations of induced spinor fields and vector fields those of gauge potentials obtained by replacing them with their super-space counterparts. Chiral condition reduces to analyticity in theta parameters thanks to the different definition of hermitian conjugation in zero energy ontology ( $\theta$  is mapped to a derivative with respect to theta rather than to  $\bar{\theta}$ ) and conjugated super-field acts on the product of all theta parameters.
    - (b) Chiral action is a straightforward generalization of the Dirac action coupled to gauge potentials. The counterpart of YM action can emerge only radiatively as an effective action so that the notion emergence is now unavoidable and indeed basic prediction of TGD.
    - (c) The propagators associated with the monomials of  $n$  theta parameters behave as  $1/p^n$  so that only  $J = 0, 1/2, 1$  states propagate in normal manner and correspond to normal particles. The presence of monomials with number of thetas higher than 2 is necessary for the propagation of bosons since by the standard argument fermion and scalar loops cancel each other by super-symmetry. This picture conforms with the identification of graviton as a bound state of wormhole throats at opposite ends of string like object. A second element essential for the finiteness of the theory is that the super-vector bosons emitted by chiral particles move collinearly as indeed required by the wormhole contact picture. Therefore these emission vertices are local in momentum space.
    - (d) This formulation allows also to use modified gamma matrices in the measurement interaction defining the counterpart of super variant of Dirac operator. Poincare invariance is not lost since momenta and color charges act on the tip of  $CD$  rather than the coordinates of the space-time sheet. Hence what is usually regarded as a quantum theory in the

background defined by classical fields follows as exact theory. This feeds all data about space-time sheet associated with the maximum of Kähler function. In this approach WCW as a Kähler manifold is replaced by a cartesian power of  $CP_2$ , which is indeed quaternionic Kähler manifold. The replacement of light-like 3-surfaces with number theoretic braids when finite measurement resolution is introduced, leads to a similar replacement.

- (e) Quantum TGD as a "complex square root" of thermodynamics approach suggests that one should take a superposition of the amplitudes defined by the points of a coherence region (identified in terms of the slicing associated with a given wormhole throat) by weighting the points with the Kähler action density. The situation would be highly analogous to a spin glass system since the modified gamma matrices defining the propagators would be analogous to the parameters of spin glass Hamiltonian allowed to have a spatial dependence. This would predict the proportionality of the coupling strengths to Kähler coupling strength and bring in the dependence on the size of  $CD$  coming as a power of 2 and give rise to p-adic coupling constant evolution. Since TGD Universe is analogous to 4-D spin glass, also a sum over different preferred extremals assignable to a given coherence regions and weighted by  $\exp(K)$  is probably needed.
- (f) In TGD Universe graviton is necessarily a bi-local object and the emission and absorption of graviton are bi-local processes involving two wormhole contacts: a pair of particles rather than single particle emits graviton. This is definitely something new and defies a description in terms of QFT limit using point like particles. Graviton like states would be entangled states of vector bosons at both ends of stringy curve so that gravitation could be regarded as a square of YM interactions in rather concrete sense. The notion of emergence would suggest that graviton propagator is defined by a bosonic loop. Since bosonic loop is dimensionless, IR cutoff defined by the largest  $CD$  present must be actively involved. At QFT limit one can hope a description as a bi-local process using a bi-local generalization of the QFT limit. It turns out that surprisingly simple candidate for the bi-local action exists.

### 10.5.2 Generalized Feynman diagrams at fermionic and momentum space level

Negative energy ontology has already led to the idea of interpreting the virtual particles as pairs of positive and negative energy wormhole throats. Hitherto I have taken it as granted that ordinary Feynman diagrammatics generalizes more or less as such. It is however far from clear what really happens in the vertices of the generalized Feynmann diagrams. The safest approach relies on the requirement that unitarity realized in terms of Cutkosky rules in ordinary Feynman diagrammatics allows a generalization. This requires loop diagrams. In particular, photon-photon scattering can take place only via a fermionic square loop so that it seems that loops must be present at least in the topological sense.

One must be however ready for the possibility that something unexpectedly simple might emerge. For instance, the vision about algebraic physics allows naturally only finite sums for diagrams and does not favor infinite perturbative expansions. Hence the true believer on algebraic physics might dream about finite number of diagrams for a given reaction type. For simplicity generalized Feynman diagrams without the complications brought by the magnetic confinement since by the previous arguments the generalization need not bring in anything essentially new.

The basic idea of duality in early hadronic models was that the lines of the dual diagram representing particles are only re-arranged in the vertices. This however does not allow to get rid of off mass shell momenta. Zero energy ontology encourages to consider a stronger form of this principle in the sense that the virtual momenta of particles could correspond to pairs of on mass shell momenta of particles. If also interacting fermions are pairs of positive and negative energy throats in the interaction region the idea about reducing the construction of Feynman diagrams to some kind of lego rules might work.

#### Virtual particles as pairs of on mass shell particles in ZEO

The first thing is to try to define more precisely what generalized Feynman diagrams are. The direct generalization of Feynman diagrams implies that both wormhole throats and wormhole contacts join

at vertices.

1. A simple intuitive picture about what happens is provided by diagrams obtained by replacing the points of Feynman diagrams (wormhole contacts) with short lines and imagining that the throats correspond to the ends of the line. At vertices where the lines meet the incoming on mass shell quantum numbers would sum up to zero. This approach leads to a straightforward generalization of Feynman diagrams with virtual particles replaced with pairs of on mass shell throat states of type  $++$ ,  $--$ , and  $+-$ . Incoming lines correspond to  $++$  type lines and outgoing ones to  $--$  type lines. The first two line pairs allow only time like net momenta whereas  $+-$  line pairs allow also space-like virtual momenta. The sign assigned to a given throat is dictated by the the sign of the on mass shell momentum on the line. The condition that Cutkosky rules generalize as such requires  $++$  and  $--$  type virtual lines since the cut of the diagram in Cutkosky rules corresponds to on mass shell outgoing or incoming states and must therefore correspond to  $++$  or  $--$  type lines.
2. The basic difference as compared to the ordinary Feynman diagrammatics is that loop integrals are integrals over mass shell momenta and that all throats carry on mass shell momenta. In each vertex of the loop mass incoming on mass shell momenta must sum up to on mass shell momentum. These constraints improve the behavior of loop integrals dramatically and give excellent hopes about finiteness. It does not however seem that only a finite number of diagrams contribute to the scattering amplitude besides tree diagrams. The point is that if a the reactions  $N_1 \rightarrow N_2$  and  $N_2 \rightarrow N_3$ , where  $N_i$  denote particle numbers, are possible in a common kinematical region for  $N_2$ -particle states then also the diagrams  $N_1 \rightarrow N_2 \rightarrow N_2 \rightarrow N_3$  are possible. The virtual states  $N_2$  include all all states in the intersection of kinematically allow regions for  $N_1 \rightarrow N_2$  and  $N_2 \rightarrow N_3$ . Hence the dream about finite number possible diagrams is not fulfilled if one allows massless particles. If all particles are massive then the particle number  $N_2$  for given  $N_1$  is limited from above and the dream is realized.
3. For instance, loops are not possible in the massless case or are highly singular (bringing in mind twistor diagrams) since the conservation laws at vertices imply that the momenta are parallel. In the massive case and allowing mass spectrum the situation is not so simple. As a first example one can consider a loop with three vertices and thus three internal lines. Three on mass shell conditions are present so that the four-momentum can vary in 1-D subspace only. For a loop involving four vertices there are four internal lines and four mass shell conditions so that loop integrals would reduce to discrete sums. Loops involving more than four vertices are expected to be impossible.
4. The proposed replacement of the elementary fermions with bound states of elementary fermions and monopoles  $X_{\pm}$  brings in the analog of stringy diagrammatics. The 2-particle wave functions in the momentum degrees of freedom of fermions and  $X_{\pm}$  might allow more flexibility and allow more loops. Note however that there are excellent hopes about the finiteness of the theory also in this case.

### Loop integrals are manifestly finite

One can make also more detailed observations about loops.

1. The simplest situation is obtained if only 3-vertices are allowed. In this case conservation of momentum however allows only collinear momenta although the signs of energy need not be the same. Particle creation and annihilation is possible and momentum exchange is possible but is always light-like in the massless case. The scattering matrices of supersymmetric YM theories would suggest something less trivial and this raises the question whether something is missing. Magnetic monopoles are an essential element of also these theories as also massivation and symmetry breaking and this encourages to think that the formation of massive states as fermion  $X_{\pm}$  pairs is needed. Of course, in TGD framework one has also high mass excitations of the massless states making the scattering matrix non-trivial.
2. In YM theories on mass shell lines would be singular. In TGD framework this is not the case since the propagator is defined as the inverse of the 3-D dimensional reduction of the modified

Dirac operator  $D$  containing also coupling to four-momentum (this is required by quantum classical correspondence and guarantees stringy propagators),

$$\begin{aligned} D &= i\hat{\Gamma}^\alpha p_\alpha + \hat{\Gamma}^\alpha D_\alpha \ , \\ p_\alpha &= p_k \partial_\alpha h^k \ . \end{aligned} \tag{10.5.1}$$

The propagator does not diverge for on mass shell massless momenta and the propagator lines are well-defined. This is of course of essential importance also in general case. Only for the incoming lines one can consider the possibility that 3-D Dirac operator annihilates the induced spinor fields. All lines correspond to generalized eigenstates of the propagator in the sense that one has  $D_3\Psi = \lambda\gamma\Psi$ , where  $\gamma$  is modified gamma matrix in the direction of the stringy coordinate emanating from light-like surface and  $D_3$  is the 3-dimensional dimensional reduction of the 4-D modified Dirac operator. The eigenvalue  $\lambda$  is analogous to energy. Note that the eigenvalue spectrum depends on 4-momentum as a parameter.

3. Massless incoming momenta can decay to massless momenta with both signs of energy. The integration measure  $d^2k/2E$  reduces to  $dx/x$  where  $x \geq 0$  is the scaling factor of massless momentum. Only light-like momentum exchanges are however possible and scattering matrix is essentially trivial. The loop integrals are finite apart from the possible delicacies related to poles since the loop integrands for given massless wormhole contact are proportional to  $dx/x^3$  for large values of  $x$ .
4. Irrespective of whether the particles are massless or not, the divergences are obtained only if one allows too high vertices as self energy loops for which the number of momentum degrees of freedom is  $3N - 4$  for  $N$ -vertex. The construction of SUSY limit of TGD in [?] led to the conclusion that the parallelly propagating  $N$  fermions for given wormhole throat correspond to a product of  $N$  fermion propagators with same four-momentum so that for fermions and ordinary bosons one has the standard behavior but for  $N > 2$  non-standard so that these excitations are not seen as ordinary particles. Higher vertices are finite only if the total number  $N_F$  of fermions propagating in the loop satisfies  $N_F > 3N - 4$ . For instance, a 4-vertex from which  $N = 2$  states emanate is finite.

### Taking into account magnetic confinement

What has been said above is not quite enough. As shown in the accompanying article and in [?] the weak form of electric-magnetic duality [?] leads to the picture about elementary particles as pairs of magnetic monopoles inspiring the notions of weak confinement based on magnetic monopole force. Also color confinement would have magnetic counterpart. This means that elementary particles would behave like string like objects in weak boson length scale. Therefore one must also consider the stringy case with wormhole throats replaced with fermion- $X_\pm$  pairs ( $X_\pm$  is electromagnetically neutral and  $\pm$  refers to the sign of the weak isospin opposite to that of fermion) and their super partners.

1. The simplest assumption in the stringy case is that fermion- $X_\pm$  pairs behave as coherent objects, that is scatter elastically. In more general case only their higher excitations identifiable in terms of stringy degrees of freedom would be created in vertices. The massivation of these states makes possible non-collinear vertices. An open question is how the massivation fermion- $X_\pm$  pairs relates to the existing TGD based description of massivation in terms of Higgs mechanism and modified Dirac operator.
2. Mass renormalization could come from self energy loops with negative energy lines as also vertex normalization. By very general arguments supersymmetry implies the cancellation of the self energy loops but would allow non-trivial vertex renormalization [?] .
3. If only 3-vertices are allowed, the loops containing only positive energy lines are possible if on mass shell fermion- $X_\pm$  pair (or its superpartner) can decay to a pair of positive energy pair particles of same kind. Whether this is possible depends on the masses involved. For ordinary particles these decays are not kinematically possible below intermediate boson mass scale (the

decays  $F_1 \rightarrow F_2 + \gamma$  are forbidden kinematically or by the absence of flavor changing neutral currents whereas intermediate gauge bosons can decay to on mass shell fermion-antifermion pair).

4. The introduction of IR cutoff for 3-momentum in the rest system associated with the largest  $CD$  (causal diamond) looks natural as scale parameter of coupling constant evolution and p-adic length scale hypothesis favors the inverse of the size scale of  $CD$  coming in powers of two. This parameter would define the momentum resolution as a discrete parameter of the p-adic coupling constant evolution. This scale does not have any counterpart in standard physics. For electron,  $d$  quark, and  $u$  quark the proper time distance between the tips of  $CD$  corresponds to frequency of 10 Hz, 1280 Hz, and 160 Hz: all these frequencies define fundamental bio-rhythms [K22] .

These considerations have left completely untouched one important aspect of generalized Feynman diagrams: the necessity to perform a functional integral over the deformations of the partonic 2-surfaces at the ends of the lines- that is integration over WCW. Number theoretical universality requires that WCW and these integrals make sense also p-adically and in the following these aspects of generalized Feynman diagrams are discussed.

### 10.5.3 Trying to understand the QFT limit of TGD

Already string models taught (or at least should have taught) to see quantum field theory as an effective description of a microscopic theory working at low energy limit. Since string theorists have not been able cook up any convincing answer to the layman's innocent question "How would you describe atom using these tiny strings which are so awe inspiring?", QFT limits have become what string models actually are at the phenomenological level. AdS-CFT correspondence actually equates string theory with a conformal quantum field theory in Minkowski space so that hopes about genuine microscopic theory are lost. This is disappointing but not surprising since strings are still too simple: they are either open or closed, there is no interesting internal topology.

In TGD framework string world sheets are replaced with 4-D space-time surfaces. One ends up with a very concrete vision about matter based on the notion of many-sheeted space-time and the implications are highly non-trivial in all scales. For instance, blackhole interior is replaced with a space-time region with Euclidian signature of the induced metric characterizing any physical system be it elementary particle, condensed matter system, or astrophysical object. Therefore the key question becomes the following.

*Does TGD have QFT in  $M^4$  as low energy limit or rather - as a limit holding true in a given scale in the infinite length scale hierarchies predicted by theory (p-adic length scale hierarchy and hierarchy of effective Planck constants and hierarchy of causal diamonds)?*

This question emerged as an outcome of an attempt to answer a series of questions related to Higgs like particle [?]. Questions were motivated by the facts that p-adic thermodynamics [K45] provides a microscopic description of particle massivation in TGD Universe and Higgs like field has no obvious classical space-time correlate. Does Higgs like particle exists in TGD Universe? If it exists as the recent LHC data strongly suggest, what is its microscopic description in TGD framework? There is indeed elegant identification of Higgs like particle in terms of bosonic emergence (bosons would const of fermion-antfermion pairs associated with wormhole contacts). Is Higgs field a proper description for the Higgs like particle at QFT limit? Does Higgs mechanism provide QFT counterpart for description in terms of p-adic thermodynamics (even if this the case, Higgs mechanism would be only a manner to parametrize particle mass spectrum rather than to predict it)? How could one construct the standard model action defining the possibly existing QFT limit of TGD? The next question is the fundamental question already stated.

Instead of trying to answer the question about the existence of QFT limit, the following argument suggests a procedure for constructing the QFT limit by applying a variant of a standard procedure by assigning various kinds of fields to the particles described as quantum states associated with wormhole contacts at the microscopic level.

#### What are the fundamental dynamical objects?

The original assumption was that elementary particles correspond to wormhole throats. With the discovery of the weak form of electric-magnetic duality came the realization that wormhole throat

is homological magnetic monopole (rather than Dirac monopole) and must therefore have (Kähler) magnetic charge. Magnetic flux lines must be however closed so that the wormhole throat must be associated with closed flux loop.

The most natural assumption is that this loop connects two wormhole throats at the first space-time sheet, that the flux goes through a second wormhole contact to another sheet, returns back along second flux tube, and eventually is transferred to the original throat along the first wormhole contact.

The solutions of the Modified Dirac equation [?] assign to this flux tube string like curve as a boundary of string world sheet carrying the induced fermion field. This closed string has "short" portions assignable to wormhole contacts and "long" portions corresponding to the flux tubes connecting the two wormhole contacts. One can assign a string tension defined by  $CP_2$  scale with the "short" portions of the string and string tension defined by the primary or perhaps secondary p-adic length scale to the "long" portions of the closed string.

Also the "long" portion of the string can contribute to the mass of the elementary particle as a contribution to the vacuum conformal weight. In the case of weak gauge bosons this would be the case and since the contribution is naturally proportional to gauge couplings strength of W/Z boson one could understand Q/Z mass ratio if the p-adic thermodynamics gives a very small contribution from the "short" piece of string (also photon would receive this small contribution in ZEO): this is the case if one must have  $T = 1/2$  for gauge bosons. Note that "long" portion of string can contribute also to fermion masses a small shift. Hence no Higgs vacuum expectation value or coherent state of Higgs would be needed. There are two options for the interpretation of recent results about Higgs and Option II in which Higgs mechanism emerges as an effective description of particle massivation at QFT limit of the theory and both gauge fields and Higgs fields and its vacuum expectation exist only as constructs making sense at QFT limit. Higgs like particles do of course exist. At WCW limit they are replaced by WCW spinor fields as fundamental object.

One can consider several identifications of the fundamental dynamical object of p-adic mass calculations. Either as a wormhole throat (in the case of fermions for which either wormhole throat carries the fermion quantum number this looks natural), as entire wormhole contact, or as the entire flux tube having two wormhole contacts. Which one of these options is correct? The strong analogy with string model implied by the presence of fermionic string world sheet would support that the identification as entire flux tube in which case the large masses for higher conformal excitations could be interpreted in terms of string tension. Note that this is the only possibility in case of gauge bosons.

### A recipe for obtaining QFT limit?

In TGD framework quantized gauge potentials and Higgs field should emerge only at  $M^4$  QFT limit. It is not even possible to speak about Higgs and YM parts of the action at the microscopic level. The functional integral defined by the vacuum function expressed as exponent of Kähler action for preferred extremals to which couplings of microscopic expressions of particles in terms of fermions coupled to the effective fields describing them at QFT limit should define the effective action at QFT limit.

The basic recipe for obtaining the effective action defining QFT limit would be simple.

1. Start from the vacuum functional which is exponent of Kähler action for preferred extremals with Euclidian regions giving real exponent and Minkowskian regions imaginary exponent.
2. Add to this action terms which are bilinear in the microscopic expression for the particle state and the corresponding effective field appearing in the effective action. Note also that the bilinears of induced spinor field defining bosons involve induced spinor fields at different wormhole throats so that local divergences are avoided.
3. Perform the functional integration over WCW ("world of classical worlds") and take vacuum expectation value in fermionic degrees of freedom.
4. This gives an effective field theory in  $M^4 \times CP_2$ . To get  $M^4$  QFT integrate over  $CP_2$  degrees of freedom in the action. This dimensional reduction is similar to what occurs in Kaluza-Klein theories. The resulting action is effective action so that there is no need to calculate loops anymore since they have been included in the functional integral over preferred extremals.

The functional integration of WCW induces also integration of induced spinor fields which apart from right-handed neutrino are restricted to the string world sheets. In principle induced spinor fields could be non-vanishing also at partonic 2-surfaces but simple physical considerations suggest that they are restricted to the intersection points of partonic 2-surfaces and string world sheets defining the ends of braid strands. Therefore the effective spinor fields  $\Psi_{eff}$  would appear only at braid ends in the integration over WCW and one has good hopes of performing the functional integral.

1. One can assign to the induced spinor fields  $\Psi$  imbedding space spinor fields  $\Psi_{eff}$  appearing in the effective action. The dimensions of  $\Psi$  and  $\Psi_{eff}$  are  $1/L^{3/2}$ . A dimensionally correct guess is the term  $\int d^2x \sqrt{g_2} \overline{\Psi_{eff}}(P) D^{-1} \Psi + h.c.$ , where  $\Gamma^\alpha$  denotes the induced gamma matrices,  $P$  denotes the end point of a braid strand at the wormhole throat, and  $D$  denotes the "ordinary" massless Dirac operator  $\Gamma^\alpha D_\alpha$  for the induced gamma matrices. Propagator contributes dimension  $L$  and is well-defined since  $\Psi$  is not annihilated by  $D$  but by the modified Dirac operator in which modified gamma matrices defined by the modified Dirac action appear. Note that internal consistency does not allow the replacement of Kähler action with four-volume. Integral over the second wormhole throat contributes dimension  $L^2$ . Therefore the outcome is a dimensionless finite quantity, which reduces to the value of integrand at the intersection of partonic 2-surface and string world sheet - that is at ends of braid strand since induced spinors are localized at string world sheets unless right-handed neutrinos are in question. The fact that induced spinor fields are proportional to a delta function restricting them to string world sheets does not lead to problems since the modified Dirac action itself vanishes by modified Dirac equation.
2. Both Higgs and gauge bosons correspond to bi-local objects consisting of fermion and anti-fermion at opposite throats of wormhole contact and restricted to braid ends. They are connected by the analog of non-integrable phase factor defined by classical gauge potentials. These bilinear fermionic objects should correspond to Higgs and gauge potentials at QFT limit. The two integrations over the partonic 2-surfaces contribute  $L^2$  both, whereas the dimension of the quantity defining the gauge boson or Higgs like state is  $1/L^3$  from the dimensions of spinor fields and from the dimension of generalized polarization vector compensated by that of gamma matrices. Hence the dimensions of the bi-local quantities are  $L$  for both gauge bosons and Higgs like particles. They must be coupled to their effective QFT counterparts so that a dimensionless term in action results. Note that delta functions associated with the induced spinor fields reduce them to the end points of braid strand connecting wormhole throats and finite result is obtained.
3. How to identify these dimensional bilinear terms defining the QFT limit? The basic problem is that the microscopic representation of the particle is bi-local and the effective field at QFT limit should be local. The only possibility is to consider an average of the effective field over the stringy curve connecting the points at two throats. The resulting quantities must have dimensions  $1/L$  in accordance with naive scaling dimensions of gauge bosons and Higgs to compensate the dimension  $L$  of the microscopic representation of bosons. For gauge bosons having zero dimension as 1-forms the average  $\int A_\mu dx^\mu / l$  along a unique stringy curve of length  $l$  connecting wormhole throats defines a quantity with dimension  $1/L$ . For Higgs components having dimension  $1/L$  the quantities  $\int H_A \sqrt{g_1} dx / l$ , where  $g_1$  corresponds to the induced metric at the stringy curve, has also dimension  $1/L$ . The presence of the induced metric depending on  $CP_2$  metric guarantees that the effective action contains dimensional parameters so that the breaking of scale invariance results.



# Mathematics

- [A1] Gaussian Mersenne. <http://primes.utm.edu/glossary/xpage/GaussianMersenne.html>.
- [A2] Z. I. Borevich and I. R. Shafarevich. *Number Theory*. Academic Press, 1966.
- [A3] Eisenhart. *Riemannian Geometry*. Princeton University Press, 1964.
- [A4] C. N. Pope G. W. Gibbons.  $CP_2$  as gravitational instanton. *Comm. Math. Phys.*, 55, 1977.
- [A5] W. Hawking, S. and N. Pope, C. Generalized Spin Structures in Quantum Gravity. *Phys. Lett.*, (1), 1978.
- [A6] S. Helgason. *Differential Geometry and Symmetric Spaces*. Academic Press, New York, 1962.
- [A7] C. Itzykson and J-B. Zuber. *Quantum Field Theory*, volume 549. Mc Graw-Hill, New York, 1980.
- [A8] J. Milnor. *Topology form Differential Point of View*. The University Press of Virginia, Virginia, 1965.
- [A9] D. S. Moak. The q-analogue of the Laguerre polynomials. *J. Math. Anal. Appl.*, 81, 1981.
- [A10] N. Pope, C. Eigenfunctions and  $Spin^c$  Structures on  $CP_2$ , 1980.
- [A11] B. Shipman. The geometry of momentum mappings on generalized flag manifolds, connections with a dynamical system, quantum mechanics and the dance of honeybee. <http://math.cornell.edu/~oliver/Shipman.gif>, 1998.
- [A12] M. Spivak. *Differential Geometry I,II,III,IV*. Publish or Perish, Boston, 1970.
- [A13] J. Hanson T. Eguchi, B. Gilkey. *Phys. Rep.*, 66:1980, 1980.
- [A14] R. Thom. *Commentarii Math. Helvet.*, 28, 1954.
- [A15] Wallace. *Differential Topology*. W. A. Benjamin, New York, 1968.
- [A16] E. C. Zeeman. *Catastrophe Theory*. Addison-Wessley Publishing Company, 1977.



# Theoretical Physics

- [B1] J. Björken and S. Drell. *Relativistic Quantum Fields*. Mc Graw-Hill, New York, 1965.
- [B2] K. Huang. *Quarks, Leptons & Gauge Fields*. World Scientific, 1982.
- [B3] R. Kiehn. Electromagnetic waves in vacuum with torsion and spin. <http://www22.pair.com/csdc/pdf/helical6.pdf>.
- [B4] G. Parisi. *Field Theory, Disorder and Simulations*. World Scientific, 1992.
- [B5] A. Zee. *The Unity of Forces in the Universe*. World Science Press, Singapore, 1982.



# Particle and Nuclear Physics

- [C1] Giant Dipole Resonance: What is Known About? <http://cdfc.sinp.msu.ru/publications/lshkhnv-ELI03.pdf>.
- [C2] Abragam A. *The principles of nuclear magnetism*. Clarendon Press, Oxford, 1961.
- [C3] C. Rolfs et al. First hints on a change of the  $^{22}\text{Na}$  beta decay half-life in the metal Pd. *Eur. Phys. J. A*, 28, 2006.
- [C4] C. Rolfs et al. High-Z electron screening, the cases  $^{50}\text{V}(p,n)^{50}$ . *Eur. Phys. J. A*, 28, 2006.
- [C5] G. Tertuchny et al. Microscopic description of the pygmy and giant electric dipole resonances in stable Ca isotopes. <http://arxiv.org/abs/nucl-th/0603/0603051>, 2006.
- [C6] S. E. Shnoll et al. Realization of discrete states during fluctuations in macroscopic processes. *Uspekhi Fisicheskikh Nauk*, 41(10):1025–1035, 1998.
- [C7] V. M. Lobashev et al. In *Neutrino 96*, Singapore, 1996. World Scientific.
- [C8] K. Langanke H. J. Assenbaum and C. Rolfs. *Z. Phys. A*, 327, 1987.
- [C9] A. D. Krisch. The spin of proton. *Scientific American*, May 1979.
- [C10] M. T. Ressel and M. S. Turner. *Astrophys.*, 14, 1990.
- [C11] C. Rolfs and W. S. Rodney. *Cauldrons in the Cosmos*. University of Chicago Press, Chicago, 1988.



# Books related to TGD

- [K1] M. Pitkänen. 1983.
- [K2] M. Pitkänen. Is it Possible to Understand Coupling Constant Evolution at Space-Time Level? In *Towards M-Matrix*. Onlinebook. [http://tgdtheory.com/public\\_html/tgdquant/tgdquant.html#rgflow](http://tgdtheory.com/public_html/tgdquant/tgdquant.html#rgflow), 2006.
- [K3] M. Pitkänen. About Strange Effects Related to Rotating Magnetic Systems . In *TGD and Fringe Physics*. Onlinebook. [http://tgdtheory.com/public\\_html/freenergy/freenergy.html#Faraday](http://tgdtheory.com/public_html/freenergy/freenergy.html#Faraday), 2006.
- [K4] M. Pitkänen. About the New Physics Behind Qualia. In *Quantum Hardware of Living Matter*. Onlinebook. [http://tgdtheory.com/public\\_html/bioware/bioware.html#newphys](http://tgdtheory.com/public_html/bioware/bioware.html#newphys), 2006.
- [K5] M. Pitkänen. An Overview about Quantum TGD: Part I. In *Topological Geometrodynamics: Overview*. Onlinebook. [http://tgdtheory.com/public\\_html/tgdview/tgdview.html#evoII](http://tgdtheory.com/public_html/tgdview/tgdview.html#evoII), 2006.
- [K6] M. Pitkänen. An Overview about the Evolution of Quantum TGD. In *Topological Geometrodynamics: Overview*. Onlinebook. [http://tgdtheory.com/public\\_html/tgdview/tgdview.html#evoI](http://tgdtheory.com/public_html/tgdview/tgdview.html#evoI), 2006.
- [K7] M. Pitkänen. Anomalies Related to the Classical  $Z^0$  Force and Gravitation. In *TGD and Fringe Physics*. Onlinebook. [http://tgdtheory.com/public\\_html/freenergy/freenergy.html#Zanom](http://tgdtheory.com/public_html/freenergy/freenergy.html#Zanom), 2006.
- [K8] M. Pitkänen. Appendix A: Quantum Groups and Related Structures. In *Towards M-Matrix*. Onlinebook. [http://tgdtheory.com/public\\_html/tgdquant/tgdquant.html#bialgebra](http://tgdtheory.com/public_html/tgdquant/tgdquant.html#bialgebra), 2006.
- [K9] M. Pitkänen. Basic Extremals of Kähler Action. In *Physics in Many-Sheeted Space-Time*. Onlinebook. [http://tgdtheory.com/public\\_html/tgdclass/tgdclass.html#class](http://tgdtheory.com/public_html/tgdclass/tgdclass.html#class), 2006.
- [K10] M. Pitkänen. *Bio-Systems as Conscious Holograms*. Onlinebook. [http://tgdtheory.com/public\\_html/hologram/hologram.html](http://tgdtheory.com/public_html/hologram/hologram.html), 2006.
- [K11] M. Pitkänen. Bio-Systems as Conscious Holograms. In *Bio-Systems as Conscious Holograms*. Onlinebook. [http://tgdtheory.com/public\\_html/hologram/hologram.html#hologram](http://tgdtheory.com/public_html/hologram/hologram.html#hologram), 2006.
- [K12] M. Pitkänen. *Bio-Systems as Self-Organizing Quantum Systems*. Onlinebook. [http://tgdtheory.com/public\\_html/bioselforg/bioselforg.html](http://tgdtheory.com/public_html/bioselforg/bioselforg.html), 2006.
- [K13] M. Pitkänen. Bio-Systems as Super-Conductors: part I. In *Quantum Hardware of Living Matter*. Onlinebook. [http://tgdtheory.com/public\\_html/bioware/bioware.html#superc1](http://tgdtheory.com/public_html/bioware/bioware.html#superc1), 2006.
- [K14] M. Pitkänen. Bio-Systems as Super-Conductors: part II. In *Quantum Hardware of Living Matter*. Onlinebook. [http://tgdtheory.com/public\\_html/bioware/bioware.html#superc2](http://tgdtheory.com/public_html/bioware/bioware.html#superc2), 2006.
- [K15] M. Pitkänen. Configuration Space Spinor Structure. In *Quantum Physics as Infinite-Dimensional Geometry*. Onlinebook. [http://tgdtheory.com/public\\_html/tgdgeom/tgdgeom.html#cspin](http://tgdtheory.com/public_html/tgdgeom/tgdgeom.html#cspin), 2006.

- [K16] M. Pitkänen. Construction of elementary particle vacuum functionals. In *p-Adic Length Scale Hypothesis and Dark Matter Hierarchy*. Onlinebook. [http://tgdtheory.com/public\\_html/paddark/paddark.html#elvafu](http://tgdtheory.com/public_html/paddark/paddark.html#elvafu), 2006.
- [K17] M. Pitkänen. Construction of Quantum Theory: M-matrix. In *Towards M-Matrix*. Onlinebook. [http://tgdtheory.com/public\\_html/tgdquant/tgdquant.html#towards](http://tgdtheory.com/public_html/tgdquant/tgdquant.html#towards), 2006.
- [K18] M. Pitkänen. Cosmic Strings. In *Physics in Many-Sheeted Space-Time*. Onlinebook. [http://tgdtheory.com/public\\_html/tgdclass/tgdclass.html#cstrings](http://tgdtheory.com/public_html/tgdclass/tgdclass.html#cstrings), 2006.
- [K19] M. Pitkänen. Crop Circles and Life at Parallel Space-Time Sheets. In *Magnetospheric Consciousness*. Onlinebook. [http://tgdtheory.com/public\\_html/magnconsc/magnconsc.html#crop1](http://tgdtheory.com/public_html/magnconsc/magnconsc.html#crop1), 2006.
- [K20] M. Pitkänen. Crop Circles and Life at Parallel Space-Time Sheets. In *Magnetospheric Consciousness*. Onlinebook. [http://tgdtheory.com/public\\_html/magnconsc/magnconsc.html#crop2](http://tgdtheory.com/public_html/magnconsc/magnconsc.html#crop2), 2006.
- [K21] M. Pitkänen. Dark Forces and Living Matter. In *p-Adic Length Scale Hypothesis and Dark Matter Hierarchy*. Onlinebook. [http://tgdtheory.com/public\\_html/paddark/paddark.html#darkforces](http://tgdtheory.com/public_html/paddark/paddark.html#darkforces), 2006.
- [K22] M. Pitkänen. Dark Matter Hierarchy and Hierarchy of EEGs. In *TGD and EEG*. Onlinebook. [http://tgdtheory.com/public\\_html/tgdeeg/tgdeeg.html#eegdark](http://tgdtheory.com/public_html/tgdeeg/tgdeeg.html#eegdark), 2006.
- [K23] M. Pitkänen. Dark Nuclear Physics and Condensed Matter. In *p-Adic Length Scale Hypothesis and Dark Matter Hierarchy*. Onlinebook. [http://tgdtheory.com/public\\_html/paddark/paddark.html#exonuclear](http://tgdtheory.com/public_html/paddark/paddark.html#exonuclear), 2006.
- [K24] M. Pitkänen. DNA as Topological Quantum Computer. In *Genes and Memes*. Onlinebook. [http://tgdtheory.com/public\\_html/genememe/genememe.html#dnatqc](http://tgdtheory.com/public_html/genememe/genememe.html#dnatqc), 2006.
- [K25] M. Pitkänen. Does TGD Predict the Spectrum of Planck Constants? In *Towards M-Matrix*. Onlinebook. [http://tgdtheory.com/public\\_html/tgdquant/tgdquant.html#Planck](http://tgdtheory.com/public_html/tgdquant/tgdquant.html#Planck), 2006.
- [K26] M. Pitkänen. Evolution in Many-Sheeted Space-Time. In *Genes and Memes*. Onlinebook. [http://tgdtheory.com/public\\_html/genememe/genememe.html#prebio](http://tgdtheory.com/public_html/genememe/genememe.html#prebio), 2006.
- [K27] M. Pitkänen. General Ideas about Many-Sheeted Space-Time: Part I. In *Physics in Many-Sheeted Space-Time*. Onlinebook. [http://tgdtheory.com/public\\_html/tgdclass/tgdclass.html#topcond](http://tgdtheory.com/public_html/tgdclass/tgdclass.html#topcond), 2006.
- [K28] M. Pitkänen. General Theory of Qualia. In *Bio-Systems as Conscious Holograms*. Onlinebook. [http://tgdtheory.com/public\\_html/hologram/hologram.html#qualia](http://tgdtheory.com/public_html/hologram/hologram.html#qualia), 2006.
- [K29] M. Pitkänen. *Genes and Memes*. Onlinebook. [http://tgdtheory.com/public\\_html/genememe/genememe.html](http://tgdtheory.com/public_html/genememe/genememe.html), 2006.
- [K30] M. Pitkänen. Genes and Memes. In *Genes and Memes*. Onlinebook. [http://tgdtheory.com/public\\_html/genememe/genememe.html#genememec](http://tgdtheory.com/public_html/genememe/genememe.html#genememec), 2006.
- [K31] M. Pitkänen. Homeopathy in Many-Sheeted Space-Time. In *Bio-Systems as Conscious Holograms*. Onlinebook. [http://tgdtheory.com/public\\_html/hologram/hologram.html#homeoc](http://tgdtheory.com/public_html/hologram/hologram.html#homeoc), 2006.
- [K32] M. Pitkänen. Macro-Temporal Quantum Coherence and Spin Glass Degeneracy. In *Bio-Systems as Conscious Holograms*. Onlinebook. [http://tgdtheory.com/public\\_html/hologram/hologram.html#macro](http://tgdtheory.com/public_html/hologram/hologram.html#macro), 2006.
- [K33] M. Pitkänen. Macroscopic Quantum Coherence and Quantum Metabolism as Different Sides of the Same Coin. In *Bio-Systems as Conscious Holograms*. Onlinebook. [http://tgdtheory.com/public\\_html/hologram/hologram.html#metab](http://tgdtheory.com/public_html/hologram/hologram.html#metab), 2006.



- [K34] M. Pitkänen. Macroscopic Quantum Phenomena and  $CP_2$  Geometry. In *Physics in Many-Sheeted Space-Time*. Onlinebook. [http://tgdtheory.com/public\\_html/tgdclass/tgdclass.html#super](http://tgdtheory.com/public_html/tgdclass/tgdclass.html#super), 2006.
- [K35] M. Pitkänen. Magnetic Sensory Canvas Hypothesis. In *TGD and EEG*. Onlinebook. [http://tgdtheory.com/public\\_html//tgdeeg/tgdeeg/tgdeeg.html#mec](http://tgdtheory.com/public_html//tgdeeg/tgdeeg/tgdeeg.html#mec), 2006.
- [K36] M. Pitkänen. *Magnetospheric Consciousness*. Onlinebook. [http://tgdtheory.com/public\\_html/magnconsc/magnconsc.html](http://tgdtheory.com/public_html/magnconsc/magnconsc.html), 2006.
- [K37] M. Pitkänen. Magnetospheric Sensory Representations. In *Magnetospheric Consciousness*. Onlinebook. [http://tgdtheory.com/public\\_html/magnconsc/magnconsc.html#srepres](http://tgdtheory.com/public_html/magnconsc/magnconsc.html#srepres), 2006.
- [K38] M. Pitkänen. Many-Sheeted DNA. In *Genes and Memes*. Onlinebook. [http://tgdtheory.com/public\\_html/genememe/genememe.html#genecodec](http://tgdtheory.com/public_html/genememe/genememe.html#genecodec), 2006.
- [K39] M. Pitkänen. Massless states and particle massivation. In *p-Adic Length Scale Hypothesis and Dark Matter Hierarchy*. Onlinebook. [http://tgdtheory.com/public\\_html/paddark/paddark.html#mless](http://tgdtheory.com/public_html/paddark/paddark.html#mless), 2006.
- [K40] M. Pitkänen. *Mathematical Aspects of Consciousness Theory*. Onlinebook. [http://tgdtheory.com/public\\_html/mathconsc/mathconsc.html](http://tgdtheory.com/public_html/mathconsc/mathconsc.html), 2006.
- [K41] M. Pitkänen. Matter, Mind, Quantum. In *TGD Inspired Theory of Consciousness*. Onlinebook. [http://tgdtheory.com/public\\_html/tgdconsc/tgdconsc.html#conscic](http://tgdtheory.com/public_html/tgdconsc/tgdconsc.html#conscic), 2006.
- [K42] M. Pitkänen. Negentropy Maximization Principle. In *TGD Inspired Theory of Consciousness*. Onlinebook. [http://tgdtheory.com/public\\_html/tgdconsc/tgdconsc.html#nmpc](http://tgdtheory.com/public_html/tgdconsc/tgdconsc.html#nmpc), 2006.
- [K43] M. Pitkänen. New Particle Physics Predicted by TGD: Part I. In *p-Adic Length Scale Hypothesis and Dark Matter Hierarchy*. Onlinebook. [http://tgdtheory.com/public\\_html/paddark/paddark.html#mass4](http://tgdtheory.com/public_html/paddark/paddark.html#mass4), 2006.
- [K44] M. Pitkänen. Nuclear String Hypothesis. In *p-Adic Length Scale Hypothesis and Dark Matter Hierarchy*. Onlinebook. [http://tgdtheory.com/public\\_html/paddark/paddark.html#nuclstring](http://tgdtheory.com/public_html/paddark/paddark.html#nuclstring), 2006.
- [K45] M. Pitkänen. *p-Adic length Scale Hypothesis and Dark Matter Hierarchy*. Onlinebook. [http://tgdtheory.com/public\\_html/paddark/paddark.html](http://tgdtheory.com/public_html/paddark/paddark.html), 2006.
- [K46] M. Pitkänen. p-Adic Particle Massivation: Hadron Masses. In *p-Adic Length Scale Hypothesis and Dark Matter Hierarchy*. Onlinebook. [http://tgdtheory.com/public\\_html/paddark/paddark.html#mass3](http://tgdtheory.com/public_html/paddark/paddark.html#mass3), 2006.
- [K47] M. Pitkänen. p-Adic Physics as Physics of Cognition and Intention. In *TGD Inspired Theory of Consciousness*. Onlinebook. [http://tgdtheory.com/public\\_html/tgdconsc/tgdconsc.html#cognic](http://tgdtheory.com/public_html/tgdconsc/tgdconsc.html#cognic), 2006.
- [K48] M. Pitkänen. *Physics in Many-Sheeted Space-Time*. Onlinebook. [http://tgdtheory.com/public\\_html/tgdclass/tgdclass.html](http://tgdtheory.com/public_html/tgdclass/tgdclass.html), 2006.
- [K49] M. Pitkänen. Quantum Antenna Hypothesis. In *Quantum Hardware of Living Matter*. Onlinebook. [http://tgdtheory.com/public\\_html/bioware/bioware.html#tubuc](http://tgdtheory.com/public_html/bioware/bioware.html#tubuc), 2006.
- [K50] M. Pitkänen. Quantum Astrophysics. In *Physics in Many-Sheeted Space-Time*. Onlinebook. [http://tgdtheory.com/public\\_html/tgdclass/tgdclass.html#qastro](http://tgdtheory.com/public_html/tgdclass/tgdclass.html#qastro), 2006.
- [K51] M. Pitkänen. Quantum Control and Coordination in Bio-systems: Part I. In *Bio-Systems as Self-Organizing Quantum Systems*. Onlinebook. [http://tgdtheory.com/public\\_html/bioselforg/bioselforg.html#qcococI](http://tgdtheory.com/public_html/bioselforg/bioselforg.html#qcococI), 2006.
- [K52] M. Pitkänen. Quantum Control and Coordination in Bio-Systems: Part II. In *Bio-Systems as Self-Organizing Quantum Systems*. Onlinebook. [http://tgdtheory.com/public\\_html/bioselforg/bioselforg.html#qcococII](http://tgdtheory.com/public_html/bioselforg/bioselforg.html#qcococII), 2006.

- [K53] M. Pitkänen. *Quantum Hardware of Living Matter*. Onlinebook. [http://tgdtheory.com/public\\_html/bioware/bioware.html](http://tgdtheory.com/public_html/bioware/bioware.html), 2006.
- [K54] M. Pitkänen. Quantum Model for Hearing. In *TGD and EEG*. Onlinebook. [http://tgdtheory.com/public\\_html//tgdeeg/tgdeeg/tgdeeg.html#hearing](http://tgdtheory.com/public_html//tgdeeg/tgdeeg/tgdeeg.html#hearing), 2006.
- [K55] M. Pitkänen. Quantum Model for Nerve Pulse. In *TGD and EEG*. Onlinebook. [http://tgdtheory.com/public\\_html//tgdeeg/tgdeeg/tgdeeg.html#pulse](http://tgdtheory.com/public_html//tgdeeg/tgdeeg/tgdeeg.html#pulse), 2006.
- [K56] M. Pitkänen. Quantum Model for Paranormal Phenomena. In *TGD Inspired Theory of Consciousness*. Onlinebook. [http://tgdtheory.com/public\\_html/tgdconsc/tgdconsc.html#parac](http://tgdtheory.com/public_html/tgdconsc/tgdconsc.html#parac), 2006.
- [K57] M. Pitkänen. Quantum Model for Sensory Representations. In *TGD Inspired Theory of Consciousness*. Onlinebook. [http://tgdtheory.com/public\\_html/tgdconsc/tgdconsc.html#expc](http://tgdtheory.com/public_html/tgdconsc/tgdconsc.html#expc), 2006.
- [K58] M. Pitkänen. Quantum Model of EEG. In *TGD and EEG*. Onlinebook. [http://tgdtheory.com/public\\_html/tgdeeg/tgdeeg.html#eegII](http://tgdtheory.com/public_html/tgdeeg/tgdeeg.html#eegII), 2006.
- [K59] M. Pitkänen. Quantum Model of Memory. In *TGD Inspired Theory of Consciousness*. Onlinebook. [http://tgdtheory.com/public\\_html/tgdconsc/tgdconsc.html#memoryc](http://tgdtheory.com/public_html/tgdconsc/tgdconsc.html#memoryc), 2006.
- [K60] M. Pitkänen. *Quantum Physics as Infinite-Dimensional Geometry*. Onlinebook. [http://tgdtheory.com/public\\_html/tgdgeom/tgdgeom.html](http://tgdtheory.com/public_html/tgdgeom/tgdgeom.html), 2006.
- [K61] M. Pitkänen. *Quantum TGD*. Onlinebook. [http://tgdtheory.com/public\\_html/tgdquant/tgdquant.html](http://tgdtheory.com/public_html/tgdquant/tgdquant.html), 2006.
- [K62] M. Pitkänen. Quantum Theory of Self-Organization. In *Bio-Systems as Self-Organizing Quantum Systems*. Onlinebook. [http://tgdtheory.com/public\\_html/bioselforg/bioselforg.html#selforgac](http://tgdtheory.com/public_html/bioselforg/bioselforg.html#selforgac), 2006.
- [K63] M. Pitkänen. Semi-trance, Mental Illness, and Altered States of Consciousness. In *Magnetospheric Consciousness*. Onlinebook. [http://tgdtheory.com/public\\_html/magnconsc/magnconsc.html#semitrancec](http://tgdtheory.com/public_html/magnconsc/magnconsc.html#semitrancec), 2006.
- [K64] M. Pitkänen. Semitrance, Language, and Development of Civilization. In *Magnetospheric Consciousness*. Onlinebook. [http://tgdtheory.com/public\\_html/magnconsc/magnconsc.html#langsoc](http://tgdtheory.com/public_html/magnconsc/magnconsc.html#langsoc), 2006.
- [K65] M. Pitkänen. TGD and Astrophysics. In *Physics in Many-Sheeted Space-Time*. Onlinebook. [http://tgdtheory.com/public\\_html/tgdclass/tgdclass.html#astro](http://tgdtheory.com/public_html/tgdclass/tgdclass.html#astro), 2006.
- [K66] M. Pitkänen. TGD and Cosmology. In *Physics in Many-Sheeted Space-Time*. Onlinebook. [http://tgdtheory.com/public\\_html/tgdclass/tgdclass.html#cosmo](http://tgdtheory.com/public_html/tgdclass/tgdclass.html#cosmo), 2006.
- [K67] M. Pitkänen. *TGD and EEG*. Onlinebook. [http://tgdtheory.com/public\\_html/tgdeeg/tgdeeg.html](http://tgdtheory.com/public_html/tgdeeg/tgdeeg.html), 2006.
- [K68] M. Pitkänen. *TGD and Fringe Physics*. Onlinebook. [http://tgdtheory.com/public\\_html/freenergy/freenergy.html](http://tgdtheory.com/public_html/freenergy/freenergy.html), 2006.
- [K69] M. Pitkänen. TGD and Nuclear Physics. In *p-Adic Length Scale Hypothesis and Dark Matter Hierarchy*. Onlinebook. [http://tgdtheory.com/public\\_html/paddark/paddark.html#padnucl](http://tgdtheory.com/public_html/paddark/paddark.html#padnucl), 2006.
- [K70] M. Pitkänen. *TGD as a Generalized Number Theory*. Onlinebook. [http://tgdtheory.com/public\\_html/tgdnumber/tgdnumber.html](http://tgdtheory.com/public_html/tgdnumber/tgdnumber.html), 2006.
- [K71] M. Pitkänen. TGD as a Generalized Number Theory: p-Adicization Program. In *TGD as a Generalized Number Theory*. Onlinebook. [http://tgdtheory.com/public\\_html/tgdnumber/tgdnumber.html#visiona](http://tgdtheory.com/public_html/tgdnumber/tgdnumber.html#visiona), 2006.

- [K72] M. Pitkänen. TGD as a Generalized Number Theory: Quaternions, Octonions, and their Hyper Counterparts. In *TGD as a Generalized Number Theory*. Onlinebook. [http://tgdtheory.com/public\\_html/tgdnumber/tgdnumber.html#visionb](http://tgdtheory.com/public_html/tgdnumber/tgdnumber.html#visionb), 2006.
- [K73] M. Pitkänen. TGD Based Model for OBEs. In *TGD Inspired Theory of Consciousness*. Onlinebook. [http://tgdtheory.com/public\\_html/tgdconsc/tgdconsc.html#OBE](http://tgdtheory.com/public_html/tgdconsc/tgdconsc.html#OBE), 2006.
- [K74] M. Pitkänen. *TGD Inspired Theory of Consciousness*. Onlinebook. [http://tgdtheory.com/public\\_html/tgdconsc/tgdconsc.html](http://tgdtheory.com/public_html/tgdconsc/tgdconsc.html), 2006.
- [K75] M. Pitkänen. TGD Inspired Theory of Consciousness. In *Topological Geometrodynamics: Overview*. Onlinebook. [http://tgdtheory.com/public\\_html/tgdview/tgdview.html#tgdconsc2010](http://tgdtheory.com/public_html/tgdview/tgdview.html#tgdconsc2010), 2006.
- [K76] M. Pitkänen. The Notion of Free Energy and Many-Sheeted Space-Time Concept. In *TGD and Fringe Physics*. Onlinebook. [http://tgdtheory.com/public\\_html/freenergy/freenergy.html#freenergy](http://tgdtheory.com/public_html/freenergy/freenergy.html#freenergy), 2006.
- [K77] M. Pitkänen. The Relationship Between TGD and GRT. In *Physics in Many-Sheeted Space-Time*. Onlinebook. [http://tgdtheory.com/public\\_html/tgdclass/tgdclass.html#tgdgrt](http://tgdtheory.com/public_html/tgdclass/tgdclass.html#tgdgrt), 2006.
- [K78] M. Pitkänen. Three new physics realizations of the genetic code and the role of dark matter in bio-systems. In *Genes and Memes*. Onlinebook. [http://tgdtheory.com/public\\_html/genememe/genememe.html#dnatqccodes](http://tgdtheory.com/public_html/genememe/genememe.html#dnatqccodes), 2006.
- [K79] M. Pitkänen. Time, Spacetime and Consciousness. In *Bio-Systems as Conscious Holograms*. Onlinebook. [http://tgdtheory.com/public\\_html/hologram/hologram.html#time](http://tgdtheory.com/public_html/hologram/hologram.html#time), 2006.
- [K80] M. Pitkänen. *Topological Geometrodynamics: an Overview*. Onlinebook. [http://tgdtheory.com/public\\_html/tgdview/tgdview.html](http://tgdtheory.com/public_html/tgdview/tgdview.html), 2006.
- [K81] M. Pitkänen. Topological Quantum Computation in TGD Universe. In *Genes and Memes*. Onlinebook. [http://tgdtheory.com/public\\_html/genememe/genememe.html#tqc](http://tgdtheory.com/public_html/genememe/genememe.html#tqc), 2006.
- [K82] M. Pitkänen. Was von Neumann Right After All. In *Towards M-Matrix*. Onlinebook. [http://tgdtheory.com/public\\_html/tgdquant/tgdquant.html#vNeumann](http://tgdtheory.com/public_html/tgdquant/tgdquant.html#vNeumann), 2006.
- [K83] M. Pitkänen. Wormhole Magnetic Fields. In *Quantum Hardware of Living Matter*. Onlinebook. [http://tgdtheory.com/public\\_html/bioware/bioware.html#wormc](http://tgdtheory.com/public_html/bioware/bioware.html#wormc), 2006.



## Chapter 11

# Does the QFT Limit of TGD Have Space-Time Super-Symmetry?

### 11.1 Introduction

Contrary to the original expectations, TGD seems to allow a generalization of the space-time super-symmetry. This became clear with the increased understanding of the modified Dirac action [K15, ?] . The introduction of a measurement interaction term to the action allows to understand how stringy propagator results and provides profound insights about physics predicted by TGD. Also an old anomalous particle production event [?] that I learned of in the blog of Tommaso Dorigo [?] having interpretation in terms of super-symmetry forced to reconsider the possibility of space-time super-symmetry in TGD [K43] .

The appearance of the momentum and color quantum numbers in the measurement interaction couples space-time degrees of freedom to quantum numbers and allows also to define SUSY algebra at fundamental level as anti-commutation relations of fermionic oscillator operators. Depending on the situation  $\mathcal{N} = 2N$  SUSY algebra or fermionic part of super-conformal algebra with infinite number of oscillator operators results. The addition of fermion in particular mode would define particular super-symmetry. Zero energy ontology implies that fermions as wormhole throats correspond to chiral super-fields assignable to positive or negative energy SUSY algebra whereas bosons as wormhole contacts with two throats correspond to the direct sum of positive and negative energy algebra and to fields which are chiral or antichiral with respect to both positive and negative energy theta parameters. This super-symmetry is badly broken due to the dynamics of the modified Dirac operator which also mixes  $M^4$  chiralities inducing massivation. Since righthanded neutrino has no electro-weak couplings the breaking of the corresponding super-symmetry should be weakest.

The question is whether this SUSY has a realization as a SUSY algebra at space-time level and whether the QFT limit of TGD could be formulated as a generalization of SUSY QFT. There are several problems involved.

1. In TGD framework super-symmetry means addition of fermion to the state and since the number of spinor modes is larger states with large spin and fermion numbers are obtained. This picture does not fit to the standard view about super-symmetry. In particular, the identification of theta parameters as Majorana spinors and super-charges as Hermitian operators is not possible.
2. The belief that Majorana spinors are somehow an intrinsic aspect of super-symmetry is however only a belief. Weyl spinors meaning complex theta parameters are also possible. Theta parameters can also carry fermion number meaning only the supercharges carry fermion number and are non-hermitian. The the general classification of super-symmetric theories indeed demonstrates that for  $D = 8$  Weyl spinors and complex and non-hermitian super-charges are possible. The original motivation for Majorana spinors might come from MSSM assuming that right handed neutrino does not exist. This belief might have also led to string theories in D=10 and D=11 as the only possible candidates for TOE after it turned out that chiral anomalies cancel.
3. The massivation of particles is the basic problem of both SUSYs and twistor approach. The fact that particles which are massive in  $M^4$  sense can be interpreted as massless particles in

$M^4 \times CP_2$  suggests a manner to understand super-symmetry breaking and massivation in TGD framework. In particular, the massive particle can be put in short representations of SUSY even when the massivation is by p-adic thermodynamics. The octonionic realization of twistors is a very attractive possibility in this framework and quaternionicity condition guaranteeing associativity leads to twistors which are almost equivalent with ordinary 4-D twistors.

It seems possible to formulate even quantum TGD proper in terms of super-field defined in the world of classical worlds (WCW). Super-fields would provide in this framework an elegant book-keeping apparatus for the elements of local Clifford algebra of WCW extended to fields in the  $M^4 \times CP_2$  whose points label the positions of the tips of the causal diamonds ( $CDs$ ). What the actual construction of SUSY QFT limit means depends on how strong approximations one wants to make.

1. The minimal approach to SUSY QFT limit is based on an approximation assuming only the super-multiplets generated by right-handed neutrino or both right-handed neutrino and its antineutrino. The assumption that right-handed neutrino has fermion number opposite to that of the fermion associated with the wormhole throat implies that bosons correspond to  $\mathcal{N} = (1, 1)$  SUSY and fermions to  $\mathcal{N} = 1$  SUSY identifiable also as a short representation of  $\mathcal{N} = (1, 1)$  SUSY algebra trivial with respect to positive or negative energy algebra. This means a deviation from the standard view but the standard SUSY gauge theory formalism seems to apply in this case.
2. A more ambitious approach would put the modes of induced spinor fields up to some cutoff into super-multiplets. At the level next to the one described above the lowest modes of the induced spinor fields would be included. The very large value of  $\mathcal{N}$  means that  $\mathcal{N} \leq \exists \in$  SUSY cannot define the QFT limit of TGD for higher cutoffs. One should generalize SUSY's gauge theories to arbitrary value of  $\mathcal{N}$  but there are reasons to expect that the formalism becomes rather complex. More ambitious approach working at TGD however suggest a more general manner to avoid this problem.
  - (a) One of the key predictions of TGD is that gauge bosons and Higgs can be regarded as bound states of fermion and antifermion located at opposite throats of a wormhole contact. This implies bosonic emergence meaning that its QFT limit can be defined in terms of Dirac action. The resulting theory was discussed in detail in [?] and it was shown that bosonic propagators and vertices can be constructed as fermionic loops so that all coupling constant follow as predictions. One must however pose cutoffs in mass squared and hyperbolic angle assignable to the momenta of fermions appearing in the loops in order to obtain finite theory and to avoid massivation of bosons. The resulting coupling constant evolution is consistent with low energy phenomenology if the cutoffs in hyperbolic angle as a function of p-adic length scale is chosen suitably.
  - (b) The generalization of bosonic emergence that the TGD counterpart of SUSY is obtained by the replacement of Dirac action with action for chiral super-field coupled to vector field as the action defining the theory so that the propagators of bosons and all their super-counterparts would emerge as fermionic loops.
  - (c) The huge super-symmetries give excellent hopes about the cancelation of infinities so that this approach would work even without the cutoffs in mass squared and hyperbolic angle assignable to the momenta of fermions appearing in the loops. Cutoffs have a physical motivation in zero energy ontology but it could be an excellent approximation to take them to infinity. Alternatively, super-symmetric dynamics provides cutoffs dynamically.
3. The intriguing formal analogy of the Kähler potential and super-potential with the Kähler function defining the Kähler metric of WCW and determined up to a real part of analytic function of the complex coordinates of WCW. This analogy suggests that the action defining the SUSY-Kähler potential- is identifiable as the Kähler function defining WCW Kähler metric at its maximum. Super-potential in turn would correspond to a holomorphic function defining the modification of Kähler function due and the space-time sheet due to measurement interaction. This beautiful correspondence would make WCW geometry directly visible in the properties of QFT limit of TGD.

4. The condition that  $\mathcal{N} = \infty$  variants for chiral and vector superfields exist fixes completely the identification of these fields in zero energy ontology.
- (a) In this framework chiral fields are generalizations of induced spinor fields and vector fields those of gauge potentials obtained by replacing them with their super-space counterparts. Chiral condition reduces to analyticity in theta parameters thanks to the different definition of hermitian conjugation in zero energy ontology ( $\theta$  is mapped to a derivative with respect to theta rather than to  $\bar{\theta}$ ) and conjugated super-field acts on the product of all theta parameters.
  - (b) Chiral action is a straightforward generalization of the Dirac action coupled to gauge potentials. The counterpart of YM action can emerge only radiatively as an effective action so that the notion emergence is now unavoidable and indeed basic prediction of TGD.
  - (c) The propagators associated with the monomials of  $n$  theta parameters behave as  $1/p^n$  so that only  $J = 0, 1/2, 1$  states propagate in normal manner and correspond to normal particles. The presence of monomials with number of thetas higher than 2 is necessary for the propagation of bosons since by the standard argument fermion and scalar loops cancel each other by super-symmetry. This picture conforms with the identification of graviton as a bound state of wormhole throats at opposite ends of string like object. A second element essential for the finiteness of the theory is that the super-vector bosons emitted by chiral particles move collinearly as indeed required by the wormhole contact picture. Therefore these emission vertices are local in momentum space.
  - (d) This formulation allows also to use modified gamma matrices in the measurement interaction defining the counterpart of super variant of Dirac operator. Poincare invariance is not lost since momenta and color charges act on the tip of  $CD$  rather than the coordinates of the space-time sheet. Hence what is usually regarded as a quantum theory in the background defined by classical fields follows as exact theory. This feeds all data about space-time sheet associated with the maximum of Kähler function. In this approach WCW as a Kähler manifold is replaced by a cartesian power of  $CP_2$ , which is indeed quaternionic Kähler manifold. The replacement of light-like 3-surfaces with number theoretic braids when finite measurement resolution is introduced, leads to a similar replacement.
  - (e) Quantum TGD as a "complex square root" of thermodynamics approach suggests that one should take a superposition of the amplitudes defined by the points of a coherence region (identified in terms of the slicing associated with a given wormhole throat) by weighting the points with the Kähler action density. The situation would be highly analogous to a spin glass system since the modified gamma matrices defining the propagators would be analogous to the parameters of spin glass Hamiltonian allowed to have a spatial dependence. This would predict the proportionality of the coupling strengths to Kähler coupling strength and bring in the dependence on the size of  $CD$  coming as a power of 2 and give rise to p-adic coupling constant evolution. Since TGD Universe is analogous to 4-D spin glass, also a sum over different preferred extremals assignable to a given coherence regions and weighted by  $\exp(K)$  is probably needed.
  - (f) In TGD Universe graviton is necessarily a bi-local object and the emission and absorption of graviton are bi-local processes involving two wormhole contacts: a pair of particles rather than single particle emits graviton. This is definitely something new and defies a description in terms of QFT limit using point like particles. Graviton like states would be entangled states of vector bosons at both ends of stringy curve so that gravitation could be regarded as a square of YM interactions in rather concrete sense. The notion of emergence would suggest that graviton propagator is defined by a bosonic loop. Since bosonic loop is dimensionless, IR cutoff defined by the largest  $CD$  present must be actively involved. At QFT limit one can hope a description as a bi-local process using a bi-local generalization of the QFT limit. It turns out that surprisingly simple candidate for the bi-local action exists.

The plan of the chapter reflects partially my own selfish needs. I have to learn space-time super-symmetry at the level of the basic formalism and the best manner to do it is to write it out.

1. The chapter begins with a brief summary of the basic concepts of SUSYs without doubt revealing my rather fragmentary knowledge about these theories. My only excuse is that I really thought that space-time super-symmetries and the formalism of SUSY theories do not generalize in TGD framework.
2. Just learning the basics led to amazing findings. First, the anti-commutation relations of the fermionic oscillator operators for the modified Dirac action can be formulated as a generalized SUSY algebra for space-time super-symmetries with large or even infinite value of  $\mathcal{N} = 2N$ . Secondly, the notion of super-field allows an elegant formulation for the local Clifford algebra of WCW. And thirdly, Kähler potential and super-potential have interpretation in terms of the Kähler function characterizing WCW geometry. I can now grasp why SUSY aficionados are so fascinated about their brain child.
3. The octonionic formulation of the modified Dirac equation leading to a general solution ansatz working also for the ordinary gamma matrix algebra is discussed to demonstrate what is involved. The notions of hyper-octonionic twistor and induced hyper-quaternionic twistor structure [K15, ?] are introduced. Hyper-quaternionicity can be realized for the induced octonionic algebra and natural matrix representations are obtained using structure constants.
4. Twistors have indeed become a part of the calculational arsenal of SUSY gauge theories, and TGD leads to a proposal how to avoid the problems caused by massive particles by using the notion of masslessness in 8-D sense and the notion of induced octo-twistor. At QFT limit the idea is simple: massless free particles correspond to geodesics of  $M^4 \times CP_2$  and in QFT formulation one keeps just the knowledge that particle moves along geodesic circle  $S^1 \times CP_2$ .
5. SUSY algebras at the level of quantum TGD proper and its QFT limit are discussed and the conditions guaranteeing that standard SUSY formalism applies are discussed: in this theory fermions *resp.* bosons correspond to  $\mathcal{N} = 1$  *resp.*  $\mathcal{N} = (1, 1)$  SUSY.
6. Finally, SUSY QFT limit of quantum TGD based on the generalization of the bosonic emergence [?] is proposed. The generalization of SUSY YM action emerges radiatively through super-symmetric fermion loops in this framework and the counterpart of chiral action is the fundamental action. The first approach applying only for small values of  $\mathcal{N}$  relies on the replacement of the Dirac action coupled to gauge potentials with the Kähler potential defined by WCW Kähler function at its maximum. Second approach is inspired by  $\mathcal{N} = \infty$  case and based on different definition of super-fields.

This chapter is a fourth one in a series containing two chapters about twistors [?, ?] and a chapter about bosonic emergence [?]. At this moment the chapter about the generalization of twistor Grassmannian approach [?] and Yangian symmetry [?] to TGD framework [?] represents the most realistic view about what quantum TGD might be. Although a lot of cognitive dust is present, this chapter together with the chapters [?, ?] might be helpful for the reader trying to get a better understanding about my motivations and goals. There is also a connection with the topological explanation of family replacement phenomenon: by combining the assumption that  $SU(3)$  acts as dynamical symmetry acting on fermion families for vertices allows only BFF type vertices and their super-symmetric generalizations at fundamental level [K16]. Also bosonic emergence allows only BFF type vertices: this simplifies enormously the construction of  $M$ -matrix. Right-handed neutrinos have been the longstanding poorly understood issue of TGD and one can develop arguments that  $\mathcal{N} = 2$  or  $\mathcal{N} = 4$  SUSY emerges naturally in TGD framework and corresponds to the addition of a collinear right-handed neutrino and antineutrino to the state representing massless particle. It must be emphasized that also this chapter is like a lab note book, a story telling how ideas have evolved and continue to evolve.

## 11.2 SUSY briefly

The Tasi 2008 lectures by Yuri Shirman [?] provide a modern introduction to 4-dimensional  $\mathcal{N} = 1$  super-symmetry and super-symmetry breaking. In TGD framework the super-symmetry is 8-dimensional super-symmetry induced to 4-D space-time surface and one  $\mathcal{N} = 2N$  can be large so that this introduction is quite not enough for the recent purposes. This section provides only a



brief summary of the basic concepts related to SUSY algebras and SUSY QFTs and the breaking of super-symmetry is mentioned only by passing. I have also listed the crucial basic facts about  $\mathcal{N} > 1$  super-symmetry [?, ?] with emphasis in demonstrating that for 8-D super-gravity with one time-dimension super-charges are non-Hermitian and that Majorana spinors are absent as required by quantum TGD.

### 11.2.1 Weyl fermions

Gamma matrices in chiral basis.

$$\begin{aligned} \gamma^\mu &= \begin{pmatrix} 0 & \sigma^\mu \\ \bar{\sigma}^\mu & 0 \end{pmatrix}, \quad \gamma_5 = \begin{pmatrix} \sigma_0 & 0 \\ 0 & -\sigma_0 \end{pmatrix}, \\ \sigma^0 &= \begin{pmatrix} 1 & 0 \\ 0 & 1 \end{pmatrix}, \quad \sigma^1 = \begin{pmatrix} 0 & 1 \\ 1 & 0 \end{pmatrix}, \quad \sigma^2 = \begin{pmatrix} 0 & -i \\ i & 0 \end{pmatrix}, \quad \sigma^3 = \begin{pmatrix} 1 & 0 \\ 0 & -1 \end{pmatrix}, \\ \bar{\sigma}^0 &= \sigma^0, \quad \bar{\sigma}^i = -\sigma^i. \end{aligned} \quad (11.2.1)$$

Note that Pauli sigma matrices can be interpreted as matrix representation for hyper-quaternion units. Dirac spinors can be expressed in terms of Weyl spinors as

$$\Psi = \begin{pmatrix} \eta^\alpha \\ \bar{\chi}_{\dot{\alpha}}^* \end{pmatrix}. \quad (11.2.2)$$

Note that  $\bar{\chi}$  does not denote complex conjugation and that complex conjugation transforms non-dotted and dotted indices to each other.  $\eta$  and  $\bar{\chi}$  are both left handed Weyl spinors and transform according to complex conjugate representations of Lorentz group and one can interpret  $\bar{\chi}$  as representing that charge conjugate of right handed Dirac fermion.

Spinor indices can be lowered and raised using antisymmetric tensors  $\epsilon^{\alpha\beta}$  and  $\epsilon_{\dot{\alpha}\dot{\beta}}$  and one has

$$\begin{aligned} \eta^\alpha \eta_\alpha &= 0, \quad \bar{\chi}_{\dot{\alpha}}^* \bar{\chi}_{\dot{\alpha}}^* = 0, \\ \eta^\alpha \bar{\chi}_{\dot{\alpha}} &= \bar{\chi}_{\dot{\alpha}} \eta^\alpha = \epsilon^{\alpha\beta} \eta_\alpha \bar{\chi}_{\dot{\beta}}, \quad \eta^* \bar{\chi}^* = \bar{\chi}^* \eta^* = \epsilon^{\alpha\beta} \eta_\alpha^* \bar{\chi}_{\dot{\beta}}^*. \end{aligned} \quad (11.2.3)$$

Left-handed and right handed spinors can be combined to Lorentz vectors as

$$\eta_{\dot{\alpha}}^* \sigma^{\mu\dot{\alpha}\alpha} \eta_\alpha = -\eta^{*\alpha} \sigma_{\alpha\dot{\alpha}}^\mu \eta^{*\dot{\alpha}}. \quad (11.2.4)$$

The SUSY algebra at QFT limit differs from the SUSY algebra defining the fundamental anticommutators of the fermionic oscillator operators for the induced spinor fields since the modified gamma matrices defined by the Kähler action are replaced with ordinary gamma matrices. This is quite a dramatic difference and raises two questions.

The Dirac action

$$L = i\bar{\Psi}\partial_\mu\gamma^\mu\Psi - m\bar{\Psi}\Psi \quad (11.2.5)$$

for a massive particle reads in Weyl representation as

$$L = i\eta^*\partial_\mu\sigma^\mu\eta + i\bar{\chi}^*\partial_\mu\bar{\sigma}^\mu\bar{\chi} - m\bar{\chi}\eta - m\bar{\chi}^*\eta^*. \quad (11.2.6)$$

### 11.2.2 SUSY algebras

In the following 4-D SUSY algebras are discussed first following the representation of [?]. After that basic results about higher-dimensional SUSY algebras are listed with emphasis on 8-D case.

### $D = 4$ SUSY algebras

Poincare SUSY algebra contains as super-generators transforming as Weyl spinors transforming in complex conjugate representations of Lorentz group. The basic anti-commutation relations of Poincare SUSY algebra in Weyl fermion basis can be expressed as

$$\begin{aligned} \{Q_\alpha, Q_{\dot{\beta}}\} &= 2\sigma_{\alpha\dot{\beta}}^\mu P_\mu, \\ \{Q_\alpha, Q_\beta\} &= \{Q_{\dot{\alpha}}, Q_{\dot{\beta}}\} = 0, \\ [Q_\alpha, P_\mu] &= [Q_{\dot{\alpha}}, P_\mu] = 0. \end{aligned} \quad (11.2.7)$$

By taking a trace over spinor indices one obtains expression for energy as  $P^0 = \sum_i Q_i \bar{Q}_i + \bar{Q}_i Q_i$ . Since super-generators must annihilated super-symmetric ground states, the energy must vanish for them.

This algebra corresponds to simplest  $\mathcal{N} = 1$  SUSY in which only left-handed fermion appears. For  $\mathcal{N} = 1$  SUSY the super-charges are hermitian whereas in TGD framework supercharges carry fermion number. This implies that super-charges come in pairs of super charge so that  $\mathcal{N} = 2N$  must hold true and its hermitian conjugate and only the second half of super-charges can annihilate vacuum state. Weyl spinors must also come as pairs of right- and left-handed spinors.

The construction generalizes in a straightforward manner to allow arbitrary number of fermionic generators. The most general anti-commutation relations in this case are

$$\begin{aligned} \{Q_{i\alpha}, Q_{\dot{\beta}}^j\} &= 2\delta_i^j \sigma_{\alpha\dot{\beta}}^\mu P_\mu, \\ \{Q_{i\alpha}, Q_{j\beta}\} &= \epsilon_{\alpha\beta} Z_{ij}, \\ \{Q_{\dot{\alpha}}, Q_{\dot{\beta}}\} &= \epsilon^{\dot{\alpha}\dot{\beta}} Z_{ij}^*. \end{aligned} \quad (11.2.8)$$

The complex constants are called central charges because they commute with all generators of the super-Poincare group.

### Higher-dimensional SUSY algebras

The character of supersymmetry is sensitive to the dimension  $D$  of space-time and to the signature of the space-time metric higher dimensions [?]. The available spinor representations depend on  $k$ ; the maximal compact subgroup of the little group of the Lorentz that preserves the momentum of a massless particle is  $Spin(d-1) \times Spin(D-d-1)$ , where  $d$  is the number of spatial dimensions  $D-d$  is the number time dimensions and  $k$  is defined as  $k = 2d - D$ . Due to the mod 8 Bott periodicity of the homotopy groups of the Lorentz group, really we only need to consider  $k = 2d - D$  modulo 8. In TGD framework one has  $D = 8$ ,  $d = 7$  and  $k = 6$ .

For any value of  $k$  there is a Dirac representation, which is always of real dimension  $N = [2^{1+[(2d-k)/2]}]$  where  $[x]$  is the greatest integer less than or equal to  $x$ . For TGD this of course gives  $2^5 = 32$  corresponding to complex 8-component quark and lepton like spinors. For  $-2 \leq k \leq 2$  not realized in TGD there is a real Majorana spinor representation, whose dimension is  $N/2$ . When  $k$  is even (TGD) there is a Weyl spinor representation, whose real dimension is  $N/2$ . For  $k \bmod 8 = 0$  (say in super-string models) there is a Majorana-Weyl spinor, whose real dimension is  $N/4$ . For  $3 \leq k \leq 5$  so called symplectic Majorana spinor with dimension  $D/2$  and for  $k = 4$  symplectic Weyl-Majorana spinors with dimension  $D/4$  is possible. The matrix  $\Gamma_{D+1}$  defined as the product of all gamma matrices has eigenvalues  $\pm(-1)^{-k/2}$ . The eigenvalue of  $\Gamma_{D+1}$  is the chirality of the spinor. CPT theorem implies that the for  $D \bmod 4 = 0$  the numbers of left and right handed super-charges are same. For  $D \bmod 4 = 2$  the numbers of left and right handed chiralities can be different and corresponding SUSYs are classified by  $\mathcal{N} = (\mathcal{N}_L, \mathcal{N}_R)$ , where  $\mathcal{N}_L$  and  $\mathcal{N}_R$  are the numbers of left and right handed super charges. Note that in TGD the chiralities are  $\pm 1$  and correspond to quark and leptons like spinors.

TGD does not allow super-symmetry with Majorana particles. It is indeed possible to have non-hermitian super-charges [?] in dimension  $D = 8$ . In  $D = 8$  SUGRA with one time dimension super-charges are non-hermitian and Majorana particles are absent. Also in  $D = 4$  SUGRA predicts super-charges are non-hermitian super-charges but Majorana particles are present.

1.  $D = 8$  super-gravity corresponds to  $\mathcal{N} = 2$  and allows complex super-charges  $Q_\alpha^i \in 8$  and their hermitian conjugates  $\bar{Q}_{\dot{\alpha}}^i \in \bar{8}$ . The group of  $R$  symmetries is  $U(2)$ . Bosonic fields consists the metric  $g_{mn}$ , seven real scalars, six vectors, three 2-form fields and one 3-form field. Fermionic fields consist of two Weyl (left) gravitini  $\psi^{\alpha i}$ , six Weyl (right) spinors plus their hermitian conjugates of opposite chirality. There are no Majorana fermions.
2.  $D = 4, \mathcal{N} = 8$  SUGRA is second example allowing complex non-hermitian super-charges. The supercharges  $Q_\alpha^i \in 2$  and their hermitian conjugates  $\bar{Q}_{\dot{\alpha}}^i \in \bar{2}$ . R-symmetry group is  $U(8)$ . Bosonic fields are metric  $g_{mn}$ , 70 real scalars and 28 vectors. Fermionic fields are 8 Majorana gravitini  $\Psi_m^{a,i}$  and 56 Majorana spinors.

For  $\mathcal{N} = 2N$  and at least  $D = 8$  with one time dimension the super charges can be assumed to come in hermitian conjugate pairs and the non-vanishing anti-commutators can be expressed as

$$\begin{aligned}
 \{Q_{i\alpha}^\dagger, Q_{j\dot{\beta}}\} &= 2\delta_i^j \sigma_{\alpha\dot{\beta}}^\mu P_\mu, \\
 \{Q_{i\alpha}^\dagger, Q_{j\beta}\} &= \epsilon_{\alpha\beta} Z_{ij}, \\
 \{Q_{\dot{\alpha}}^\dagger, Q_{\dot{\beta}}\} &= \epsilon^{\dot{\alpha}\dot{\beta}} Z_{ij}^*.
 \end{aligned} \tag{11.2.9}$$

In this case  $Z_{ij}$  is anti-hermitian matrix. 8-D chiral invariance (separate conservation of lepton and quark numbers) suggests strongly that that the condition  $Z_{ij} = 0$  must hold holds true. A given pair of super-charges is analogous to creation and annihilation operators for a given fermionic chirality. In TGD framework opposite chiralities correspond to quark and lepton like spinors.

### Representations of SUSY algebras in dimension $D = 4$

The physical components of super-fields correspond to states in the irreducible representations of SUSY algebras. The representations can be constructed by using the basic anticommutation relations for  $Q_{i\alpha}$  and  $Q_{j\dot{\alpha}}$ ,  $i, j \in \{1, \dots, \mathcal{N}\}$ ,  $\alpha, \dot{\alpha} \in \{1, 2\}$ . The representations can be classified to massive and massless ones. Also the presence of central charges affects the situation. A given irreducible representation is characterized by its ground state and R-parity assignments distinguish between representations with the same spin content, say fermion and its scalar super-partner and Higgs with its fermionic super-partner.

1. In the massive case one obtains in the rest system just fermionic oscillator algebra with with  $2\mathcal{N}$  fermionic creation operators and  $2\mathcal{N}$  annihilation operators. The number of states created from a vacuum state with spin  $s_0$  is  $2\mathcal{N}$  and maximum spin is  $s_0 + \mathcal{N}/2$ . For instance, for  $\mathcal{N} = 1$  and  $s_0 = 0$  one obtains for 4 states with spins  $J \leq 1/2$ . Renormalizability requires massive matter to have  $s \leq 1/2$  so that only  $\mathcal{N} = 1$  is possible in this case. For particles massless at fundamental level and getting their masses by symmetry breaking this kind of restriction does not apply.
2. In the massless case only one half of fermionic oscillator operators have vanishing anticommutators corresponding to the fact that for massless state only the second helicity is physical. This implies that the number of states is only  $2^{\mathcal{N}}$  and the helicities vary from  $\lambda_0$  to  $\lambda_0 + \mathcal{N}/2$ . For  $\mathcal{N} = 1$  the representation is 2-dimensional.
3. In the presence of central charges  $Z_{ij} = -Z_{ji}$  the representations are in general massive ( $Z_{ij}$  has dimensions of mass),  $U(N)$  acts as symmetries of  $Z$ , and since  $Z^2$  is symmetric its diagonalizability implies that  $Z$  matrix can be cast by a unitary transformation into a direct sum of 2-D antisymmetric real matrices multiplied by constants  $Z_i$ . Therefore the super-algebra can be cast in diagonal form with anticommutators proportional to  $M \pm Z_m$  with  $M - Z_m \geq 0$  by unitarity. This implies the celebrated Bogomol'nyi bound  $M \geq \max\{Z_n\}$ . For this value of varying mass parameter it is possible to have reduction of the dimension of the representation by one half. If the eigenvalues  $Z_n$  are identical the number of states is reduced to that for a massless representation. This multiplet is known as short BPS multiplet. Although BPS multiplets are massive (mass is expressible in terms of Higgs expectation value) they form multiplets shorter than the usual massive SUSY multiplets.

### 11.2.3 Super-space

The heuristic view about super-space [?] is as a manifold with  $D$  local bosonic coordinates  $x^\mu$  and  $\mathcal{N}D/2$  complex anti-commuting spinor coordinates  $\theta_i^\alpha$  and their complex conjugates  $\bar{\theta}_i^\alpha = (\theta_i^\alpha)^*$ . For  $\mathcal{N} = 1$ , which is relevant to minimally super-symmetric standard model (MSSM), the spinors  $\theta$  can also be chosen to be real that is Majorana spinors, so that one has 4 bosonic and four real coordinates. In TGD framework one must however use Weyl spinors.

The anti-commutation relations for the super-coordinates are

$$\{\theta_\alpha, \theta_\beta\} = \{\theta_{\dot{\alpha}}, \theta_{\dot{\beta}}\} = \{\theta_\alpha, \theta_{\dot{\beta}}\} = 0 . \quad (11.2.10)$$

The integrals over super-space in 4-D  $\mathcal{N} = 1$  case are defined by the following formal rules which actually state that super-integration is formally analogous to derivation.

$$\begin{aligned} \int d\theta &= \int d\bar{\theta} = \int d\theta\bar{\theta} = \int d\bar{\theta}\theta = 0 , \\ \int d\theta^\alpha d\theta_\beta &= \delta_\beta^\alpha , \quad \int d\bar{\theta}_{\dot{\alpha}} d\bar{\theta}_{\dot{\beta}} = \delta_{\dot{\alpha}}^{\dot{\beta}} , \\ \int d^2\theta\theta^2 &= \int d^2\bar{\theta}\bar{\theta}^2 , \quad \int d^4\theta\theta^2\bar{\theta}^2 = 1 . \end{aligned} \quad (11.2.11)$$

Here the shorthand notations

$$\begin{aligned} d^2\theta &\equiv -\frac{1}{4}\epsilon_{\alpha\beta}d\theta^\alpha d\theta^\beta , \\ d^2\bar{\theta} &\equiv -\frac{1}{4}\epsilon^{\dot{\alpha}\dot{\beta}}d\bar{\theta}_{\dot{\alpha}} d\bar{\theta}_{\dot{\beta}} , \\ d^4\theta &\equiv d^2\theta d^2\bar{\theta} . \end{aligned} \quad (11.2.12)$$

are used.

The generalization of the formulas to  $D > 4$  and  $\mathcal{N} > 1$  cases is trivial. In infinite-dimensional case relevant for the super-symmetrization of the WCW geometry in terms of local Clifford algebra of WCW to be proposed later the infinite number of complex theta parameters poses technical problems unless one defines super-space functions properly.

#### Chiral super-fields

Super-multiplets can be expressed as single super-field define in super-space. Super-field can be expanded as a Taylor series with respect to the theta parameters. In 4-dimensional  $\mathcal{N} = 1$  case one has

$$\Phi(x^\mu, \theta, \bar{\theta}) = \phi(x^\mu) + \theta\eta(x^\mu) + \bar{\theta}\eta^\dagger(x^\mu) + \bar{\theta}\bar{\sigma}^\alpha\theta V_\alpha(x^\mu) + \theta^2 F(x^\mu) + \bar{\theta}^2 \bar{F}(x^\mu) \dots + \theta^2\bar{\theta}^2 D(x^\mu) \quad (11.2.13)$$

The action of super-symmetries on super-fields can be expressed in terms of super-covariant derivatives defined as

$$D_\alpha = \frac{\partial}{\partial\theta^\alpha} - i\sigma_{\alpha\dot{\alpha}}^\mu \bar{\theta}^{\dot{\alpha}} \frac{\partial}{\partial x^\mu} , \quad \bar{D}_{\dot{\alpha}} = -\frac{\partial}{\partial\bar{\theta}^{\dot{\alpha}}} + i\theta^\alpha \sigma_{\alpha\dot{\alpha}}^\mu \frac{\partial}{\partial x^\mu} . \quad (11.2.14)$$

This allows very concise realization of super-symmetries.

General super-field defines a reducible representation of super-symmetry. One can construct irreducible representations of super-fields a pair of chiral and antichiral super-fields by posing the condition

$$\bar{D}_{\dot{\alpha}}\Phi = 0 , \quad D_\alpha\Phi^\dagger = 0 . \quad (11.2.15)$$

The hermitian conjugate of chiral super-field is anti-chiral.

Chiral super-fields can be expressed in the form

$$\Phi = \Phi(\theta, y^\mu) , \quad y^\mu = x^\mu + i\bar{\theta}\sigma^\mu\theta , \quad y^{\mu\dagger} = x^\mu - i\bar{\theta}\sigma^\mu\theta . \quad (11.2.16)$$

These formulas generalize in a rather straightforward manner to  $D > 4$  and  $\mathcal{N} > 1$  case.

It is easy to check that any analytic function of a chiral super-field, call it  $W(\Phi)$ , is a chiral super-field. In super-symmetries its  $\theta^2$  component transforms by a total derivative so that the action defined by the super-space integral of  $W(\phi)$  is invariant under super-symmetries. This allows to construct super-symmetric actions using  $W(\Phi)$  and  $W(\Phi^\dagger)$ . The so called super-potential is defined using the sum of  $W(\Phi) + W(\Phi^\dagger)$ .

Analytic functions of does not give rise to kinetic terms in the action. The observation  $\theta^2\bar{\theta}^2$  component of a real function of chiral super-fields transforms also as total derivative under super-symmetries allows to circumvent this problem by introducing the notion of Kähler potential  $K(\Phi, \Phi^\dagger)$  as a real function of chiral super-field and its conjugate. In he simplest case one has

$$K = \sum_i \Phi_i^\dagger \Phi_i . \quad (11.2.17)$$

$L_K = \int K d^4\theta$  gives rise to simples super-symmetric action for left-handed fermion and its scalar super-partner.

Kähler potential allows an interpretation as a Kähler function defining the Kähler metric for the manifold defined by the scalars  $\phi_i$ . This Kähler metric depends in the general case on  $\phi_i$  and appears in the kinetic term of the super-symmetric action. Super-potential in turn can be interpreted as a counterpart of real part of a complex function which can be added to the Kähler function without affect the Kähler metric. This geometric interpretation suggests that in TGD framework every complex coordinate  $\phi_i$  of WCW defines a chiral super-field whose bosonic part.

### Wess-Zumino model as simple example

Wess-Zumino model without interaction term serves as a simple illustration of above formal considerations. The action density of Wess-Zumino Witten model can be deduced by integration Kähler potential  $K = \Phi^\dagger\Phi$  for chiral super fields over theta parameters. The result is

$$L = \partial_u\phi^*\partial^\mu\phi + i\eta^*\partial^\mu\eta + F^*F . \quad (11.2.18)$$

The action of super-symmetry

$$\delta\Phi = \epsilon^\alpha D_\alpha\Phi , \quad \delta\Phi^\dagger = \bar{\epsilon}^{\dot{\alpha}}\bar{D}_{\dot{\alpha}}\Phi , \quad \epsilon_{\dot{\alpha}} = \epsilon^{*\alpha} \quad (11.2.19)$$

gives the transformation formulas

$$\delta\phi = \epsilon^\alpha\eta_\alpha , \quad \delta\eta = -i\eta^{*\dot{\alpha}}\sigma_{\dot{\alpha}\alpha}^\mu\partial_\mu\phi + \epsilon_\alpha F , \quad \delta F = -i\epsilon_{\dot{\alpha}}\bar{\sigma}^{\mu\dot{\alpha}\alpha}\partial_\mu\eta_\alpha \quad (11.2.20)$$

plus their hermitian conjugates. The corresponding Noether current is indeed hermitian since the transformation parameters  $\epsilon^\alpha$  and  $\bar{\epsilon}_{\dot{\alpha}} = \epsilon^{*\alpha}$  appear in it and cannot be divided away. This conserved current has as such no meaning and the statement that ground state is annihilated by the corresponding super-charge means that vacuum field configuration rather than Fock vacuum remains invariant under supersymmetries. Rather, the breaking of super-symmetry by adding a super-potential implies that  $F$  develops vacuum expectation and the vacuum solution ( $\phi = 0, \eta = 0, F = \text{constant}$ ) of field equations is not anymore invariant super super-symmetries.

The non-hermitian parts of the super current corresponding to different fermion numbers are separately conserved and corresponding super-charges are non-Hermitian and together with other charges define a super-algebra which to my best understanding is not equivalent with the super-algebra defined by allowing the presence of anti-commuting parameters  $\epsilon$ . The situation is similar in

TGD where one class of non-hermitian super-currents correspond to the modes of the induced spinor fields contracted with  $\bar{\Psi}$  and their conjugates. The octonionic solution ansatz for the induced spinor field allows to express the solutions in terms of two complex scalar functions so that the super-currents in question would be analogous to those of  $\mathcal{N} = 2$  SUSY and one might see the super-symmetry of quantum TGD extended super-symmetry obtained from the fundamental  $\mathcal{N} = 2$  super-symmetry.

### Vector super-fields and supersymmetric variant of YM action

Chiral super-fields allow only the super-symmetrization of Dirac action. The super-symmetrization of YM action requires the notion of a hermitian vector super field  $V = V^\dagger$ , whose components correspond to vector bosons, their super-counterparts and additional degrees of freedom which cannot be dynamical. These degrees of freedom correspond gauge degrees of freedom.

In the Abelian case the gauge symmetries are realized as  $V \rightarrow V + \Lambda + \Lambda^\dagger$ , where  $\Lambda$  is a chiral super-field. These symmetries induce gauge transformations of the vector potential. Their action on chiral super-fields is  $\Phi \rightarrow \exp(-q\Lambda)\Phi$ ,  $\Phi^\dagger \rightarrow \Phi^\dagger \exp(-\Lambda^\dagger)$ . In non-Abelian case the realization is as  $\exp(V) \rightarrow \exp(-\Lambda^\dagger)\exp(V)\exp(\Lambda)$  so that the modified Kähler potential  $K(\Phi^\dagger, \exp(qV)\Phi)$  remains invariant.

One can assign to  $V$  a gauge invariant chiral spinor super-field as

$$\begin{aligned} W_\alpha &= -\frac{1}{4}\bar{D}^2(e^V D_\alpha e^{-V}) , \\ \bar{D}^2 &= \epsilon^{\dot{\alpha}\dot{\beta}}\bar{D}_{\dot{\alpha}}\bar{D}_{\dot{\beta}} \end{aligned} \quad (11.2.21)$$

defining the analog of gauge field.  $\bar{D}^2$  eliminates all terms the exponent of  $\bar{\theta}$  is higher than that of  $\theta$  since these would spoil the chiral super-field property (the anti-commutativity of super-covariant derivatives  $\bar{D}_{\dot{\alpha}}$  makes this obvious).  $D_\alpha$  in turn eliminates from the resulting scalar part so that one indeed has chiral spinor super-field. In higher dimensions and for larger value of  $\mathcal{N}$  the definition of  $W_\alpha$  must be modified in order to achieve this: what is needed is the product of all derivatives  $\bar{D}_{i\dot{\alpha}}$ .

The analytic functions of chiral spinor super-fields are chiral super-fields and  $\theta^2$  component of  $W^\alpha W_\alpha$  transforms as a total derivatives. The super-symmetric Lagrangian of U(1) theory can be written as

$$L = \frac{1}{4g^2} \left( \int d^2\theta W^\alpha W_\alpha + \int d^2\bar{\theta} W_\alpha^\dagger W_\alpha^\dagger \right) . \quad (11.2.22)$$

Note that in standard form of YM action  $1/2g^2$  appears.

### R-symmetry

R-symmetry is an important concomitant of super-symmetry. In  $\mathcal{N} = 1$  case R-symmetry performs a phase rotation  $\theta \rightarrow e^{i\alpha}\theta$  for the super-space coordinate  $\theta$  and an opposite phase rotation for the differential  $d\theta$ . For  $\mathcal{N} > 1$  R-symmetries are  $U(N)$  rotations. R-symmetry is an additional symmetry of the Lagrangian terms due to Kähler potential since both  $d^4\theta$  (and its generalization) as well as Kähler potential are real. Also super-symmetric YM action is R-invariant. R-symmetry is a symmetry of if super-potential  $W$  only if it has super-charge  $Q_R = 2$  ( $Q_R = 2\mathcal{N}$ ) in order to compensate the super-charge of  $d^{2\mathcal{N}}\theta$ .

### 11.2.4 Non-renormalization theorems

Super-symmetry gives powerful constraints on the super-symmetric Lagrangians and leads to non-renormalization theorems.

The following general results about renormalization of supersymmetric gauge theories hold true (see [?] , where heuristic justification of the non-renormalization theorems and explicit formulas are discussed).

1. Super-potential is not affected by the renormalization.

2. Kähler potential is subject to wavefunction renormalization in all orders. The renormalization depends on the parameters with dimensions of mass. In particular, quadratic divergences to masses cancel.
3. Gauge coupling suffers renormalization only by a constant which corresponds to one-loop renormalization. Any renormalization beyond one loop is due to wave function renormalization of the Kähler potential and it is possible to calculate the beta function exactly.

It is interesting to try to see these result from TGD perspective.

1. In TGD framework super-potential interpreted as defining the modification of WCW Kähler function, which does not affect Kähler metric and would reflect measurement interaction. The non-renormalization of  $W$  would mean that the measurement interaction is not subject to renormalization. The interpretation is in terms of quantum criticality which does not allow renormalization of the coefficients appearing in the measurement interaction term since otherwise Kähler metric of WCW would be affected.
2. The wavefunction renormalization of Kähler potential would correspond in TGD framework scaling of the WCW Kähler metric. Quantum criticality requires that Kähler function remains invariant. Also since no parameters with dimensions of mass are available, there is temptation to conclude that wave function renormalization is trivial.
3. Only the gauge coupling would be suffer renormalization. If one however believes in the generalization of bosonic emergence it is Kähler function which defines the SUSY QFT limit of TGD so that gauge couplings follow as predictions and their renormalization is a secondary -albeit real- effect having interpretation in terms of the dependence of the gauge coupling on the p-adic length scale. The conclusion would be that at the fundamental level the quantum TGD is RG invariant.

## 11.3 Does TGD allow the counterpart of space-time super-symmetry?

The question whether TGD allows space-time super-symmetry or something akin to it has been a longstanding problem. A considerable progress in the respect became possible with the better understanding of the modified Dirac equation. At the same time I learned about almost 15 year old striking  $ee\gamma\gamma + \cancel{E}$  detected by CDF collaboration [?, ?] from Tommaso Dorigo's blog [?] .

### 11.3.1 Basic data bits

Let us first summarize the data bits about possible relevance of super-symmetry for TGD before the addition of the 3-D measurement interaction term to the modified Dirac action [K15, ?] .

1. Right-handed covariantly constant neutrino spinor  $\nu_R$  defines a super-symmetry in  $CP_2$  degrees of freedom in the sense that Dirac equation is satisfied by covariant constancy and there is no need for the usual ansatz  $\Psi = D\Psi_0$  giving  $D^2\Psi = 0$ . This super-symmetry allows to construct solutions of Dirac equation in  $CP_2$  [A13, A5, A10, A4] .
2. In  $M^4 \times CP_2$  this means the existence of massless modes  $\Psi = \not{p}\Psi_0$ , where  $\Psi_0$  is the tensor product of  $M^4$  and  $CP_2$  spinors. For these solutions  $M^4$  chiralities are not mixed unlike for all other modes which are massive and carry color quantum numbers depending on the  $CP_2$  chirality and charge. As matter fact, covariantly constant right-handed neutrino spinor mode is the only color singlet. The mechanism leading to non-colored states for fermions is based on super-conformal representations for which the color is neutralized [K39, ?] . The negative conformal weight of the vacuum also cancels the enormous contribution to mass squared coming from mass in  $CP_2$  degrees of freedom.
3. Right-handed covariantly constant neutrino allows to construct the gamma matrices of the world of classical worlds (WCW) as fermionic counterparts of Hamiltonians of WCW. This gives rise super-symplectic symmetry algebra having interpretation also as a conformal algebra. Also more general super-conformal symmetries exist.

4. Space-time (in the sense of Minkowski space  $M^4$ ) super-symmetry in the conventional sense of the word is impossible in TGD framework since it would require Majorana spinors. In 8-D space-time with Minkowski signature of metric Majorana spinors are definitely ruled out by the standard argument leading to super string model. Majorana spinors would also break separate conservation of lepton and baryon numbers in TGD framework.

### 11.3.2 Could one generalize super-symmetry?

Could one then consider a more general space-time super-symmetry with "space-time" identified as space-time surface rather than Minkowski space?

1. The TGD variant of the super-symmetry could correspond quite concretely to the addition to fermion and boson states right-handed neutrinos. Since right-handed neutrinos do not have electro-weak interactions, the addition might not appreciably affect the mass formula although it could affect the p-adic prime defining the mass scale.
2. The problem is to understand what this addition of the right-handed neutrino means. To begin with, notice that in TGD Universe fermions reside at light-like 3-surfaces at which the signature of induced metric changes. Bosons correspond to pairs of light-like wormhole throats with wormhole contact having Euclidian signature of the induced metric. It is essential that either fermion or antifermion in the boson state carries what might be called un-physical polarization in the standard conceptual framework. Only in this manner the helicities can come out correctly. The assumption that the bosonic wormhole throats correspond to positive and negative energy space-time sheets realizes this constraint in the framework of zero energy ontology.
3. The super-symmetry as an addition to the fermion state a second wormhole throats carrying right handed neutrino quantum numbers does not make sense since the resulting state cannot be distinguished from gauge boson or Higgs type particle. The light-like 3-surfaces can however carry fermion numbers up to the number of modes of the induced spinor field, which is expected to be infinite inside string like objects having wormhole throats at ends and finite when one has space time sheets containing the throats [?]. In very general sense one could say that each mode defines a very large broken  $N$ -super-symmetry with the value of  $N$  depending on state and light-like 3-surface. The breaking of this super-symmetry would come from electro-weak -, color -, and gravitational interactions. Right-handed neutrino would by its electro-weak and color inertness define a minimally broken super-symmetry.
4. What this addition of the right handed neutrinos or more general fermion modes could precisely mean? One cannot assign fermionic oscillator operators to right handed neutrinos which are covariantly constant in both  $M^4$  and  $CP_2$  degrees of freedom since the modes with vanishing energy (frequency) cannot correspond to fermionic oscillator operator creating a physical state since one would have  $a = a^\dagger$ . The intuitive view is that all the spinor modes move in an exactly collinear manner -somewhat like quarks inside hadron do approximately.

### 11.3.3 Modified Dirac equation briefly

The answer to the question what "collinear motion" means mathematically emerged from the recent progress in the understanding of the modified Dirac equation.

1. The modified Dirac action involves two terms. Besides the original 4-D modified Dirac action there is measurement interaction. This term correlates space-time geometry with quantum numbers assignable to super-conformal representations and is also necessary to obtain almost-stringy propagator.
2. The modified Dirac equation with measurement action added reads as

$$(D_K + Q \times O)\Psi = 0 . \quad (11.3.1)$$



- (a)  $D_K$  corresponds formally to 4-D massless Dirac operator in  $X^4$ .  $Q$  realizes measurement interaction.
- (b)  $Q$  is linear in Cartan algebra generators of the isometry algebra of imbedding space (color isospin and hypercharge plus four-momentum or two components of four momentum and spin and boost in direction of 3-momentum).  $Q$  is expressible as

$$Q = Q_A \partial_\alpha h^k g^{AB} j_{Bk} \hat{\Gamma}_K^\alpha . \quad (11.3.2)$$

Here  $Q_A$  is Cartan algebra generator acting on physical states. Physical states must be eigen states of  $Q_A$  since otherwise the equations do not make sense.  $g^{AB}$  is the inverse of the matrix defined by the imbedding space inner product of Killing vector fields  $j_A^k$  and  $j_B^l$ : its existence allows only Cartan algebra charges.

- (c) One can add to the measurement interaction also a coupling to the modified gamma matrices defined by the instanton term  $J \wedge J$  associated with Kähler action. This term is total divergence but gives rise to a sum of Chern-Simons terms localizable to the wormhole throats or to light-like 3-surface parallel to them. This term contributes a boundary condition to the solutions of the modified Dirac equation breaking CP and T invariance. The interpretation is in terms of dissipation caused by state function reductions.
- (d) In general case the modified gamma matrices are defined in terms of action density  $L$  as

$$\hat{\Gamma}^\alpha = \frac{\partial L}{\partial_\alpha h^k} \gamma^k . \quad (11.3.3)$$

$\gamma^k$  denotes imbedding space gamma matrices.

- (e) The operator  $O$  characterizes the conserved fermionic current to which Cartan algebra generators of isometries couple. The simplest conserved currents correspond to quark or lepton currents and corresponding vectorial isospin- and spin currents [?] . Besides this there is an infinite hierarchy of conserved currents relating to quantum criticality and in one-one correspondence with vanishing second variations of Kähler action for preferred extremal. These couplings allow to represent measurement interaction for any observable.
3. The equation  $(D_K + Q)\nu_R = 0$  for right-handed neutrino would reduce for vanishing color charges and covariantly constant spinor to the analog of algebraic fermionic on mass shell condition  $p_A \gamma^A \nu_R = 0$  since  $Q$  is obtained by projecting the total four-momentum of the parton state interpreted as a vector-field of  $H$  to the space-time surface and by replacing ordinary gamma matrices with the modified ones. This equation cannot be exact since  $Q$  depends on the point of the light-like 3-surface so that covariant constancy fails and  $D_K$  cannot annihilate the state. This is the space-time correlate for the breaking of super-symmetry. The action of the Cartan algebra generators is purely algebraic and on the state of super-conformal representations rather than that of a differential operator on spinor field. The modified equation implies that all spinor modes represent fermions moving collinearly in the sense an equation with the same total four-momentum and total color quantum numbers is satisfied by all of them. Note that  $p_A$  represents the total four-momentum of the state rather than individual four-momenta of fermions.

### 11.3.4 TGD counterpart of space-time super-symmetry

This picture allows to define more precisely what one means with the approximate super-symmetries in TGD framework.

1. One can in principle construct many-fermion states containing both fermions and anti-fermions at given light-like 3-surface. The four-momenta of states related by super-symmetry need not be same. Super-symmetry breaking is present and has as the space-time correlate the deviation of the modified gamma matrices from the ordinary  $M^4$  gamma matrices. In particular, the fact that  $\hat{\Gamma}^\alpha$  possesses  $CP_2$  part in general means that different  $M^4$  chiralities are mixed: a space-time correlate for the massivation of the elementary particles.

2. For right-handed neutrino super-symmetry breaking is expected to be smallest but also in the case of the right-handed neutrino mode mixing of  $M^4$  chiralities takes place and breaks the TGD counterpart of super-symmetry.
3. The fact that all helicities in the state are physical for a given light-like 3-surface has important implications. For instance, the addition of a right-handed antineutrino to right-handed (left-handed) electron state gives scalar (spin 1) state. Also states with fermion number two are obtained from fermions. For instance, for  $e_R$  one obtains the states  $\{e_R, e_R\nu_R\bar{\nu}_R, e_R\bar{\nu}_R, e_R\nu_R\}$  with lepton numbers (1, 1, 0, 2) and spins (1/2, 1/2, 0, 1). For  $e_L$  one obtains the states  $\{e_L, e_L\nu_R\bar{\nu}_R, e_L\bar{\nu}_R, e_L\nu_R\}$  with lepton numbers (1, 1, 0, 2) and spins (1/2, 1/2, 1, 0). In the case of gauge boson and Higgs type particles -allowed by TGD but not required by p-adic mass calculations- gauge boson has 15 super partners with fermion numbers [2, 1, 0, -1, -2].

The cautious conclusion is that the recent view about quantum TGD allows the analog of super-symmetry which is necessary broken and for which the multiplets are much more general than for the ordinary super-symmetry. Right-handed neutrinos might however define something resembling ordinary super-symmetry to a high extent. The question is how strong prediction one can deduce using quantum TGD and proposed super-symmetry.

1. For a minimal breaking of super-symmetry only the p-adic length scale characterizing the super-partner differs from that for partner but the mass of the state is same. This would allow only a discrete set of masses for various super-partners coming as half octaves of the mass of the particle in question. A highly predictive model results.
2. The quantum field theoretic description should be based on QFT limit of TGD formulated in terms of bosonic emergence [?] . This formulation should allow to calculate the propagators of the super-partners in terms of fermionic loops.
3. This TGD variant of space-time super-symmetry resembles ordinary super-symmetry in the sense that selection rules due to the right-handed neutrino number conservation and analogous to the conservation of R-parity hold true. The states inside super-multiplets have identical electro-weak and color quantum numbers but their p-adic mass scales can be different. It should be possible to estimate reaction rates using rules very similar to those of super-symmetric gauge theories.
4. It might be even possible to find some simple generalization of standard super-symmetric gauge theory to get rough estimates for the reaction rates. There are however problems. The fact that spins  $J = 0, 1, 2, 3/2, 2$  are possible for super-partners of gauge bosons forces to ask whether these additional states define an analog of non-stringy strong gravitation. Note that graviton in TGD framework corresponds to a pair of wormhole throats connected by flux tube (counterpart of string) and for gravitons one obtains  $2^8$ -fold degeneracy.

### 11.3.5 Experimental indication for space-time super-symmetry

There is experimental indication for super-symmetry dating back to 1995 [?] . The event involves  $e^+e^-\gamma\gamma$  plus missing transverse energy  $\cancel{E}_T$ . The electron-positron pair has transversal energies  $E_T = (36, 59)$  GeV and invariant mass  $M_{ee} = 165$  GeV. The two photons have transversal energies (30,38) GeV. The missing transverse energy is  $\cancel{E}_T = 53$  GeV. The cross sections for these events in standard model are too small to be observed. Statistical fluctuation could be in question but one could also consider the event as an indication for super-symmetry.

In [?] an explanation of the event in terms of minimal super-symmetric standard model (MSSM) was proposed.

1. The collision of proton and antiproton would induce an annihilation of quark and antiquark to selectron pair  $\tilde{e}^-\tilde{e}^+$  via virtual photon or  $Z^0$  boson with the mass of  $\tilde{e}$  in the range (80,130) GeV (the upper bound comes from the total energy of the particles involved).
2.  $\tilde{e}^\pm$  would in turn decay to  $e^\pm$  and neutralino  $\chi_2^0$  and  $\chi_2^0$  to the lightest super-symmetric particle  $\chi_1^0$  and photon. The neutralinos are in principle mixtures of the super partners associated with

$\gamma$ ,  $Z^0$ , and neutral higgs  $h$  (there are two of them in minimal super-symmetric generalization of standard model). The highest probability for the chain is obtained if  $\chi_2^0$  is gluino and  $\chi_1^0$  is higgsino.

3. The kinematics of the event allows to deduce the bounds

$$\begin{aligned}
 80 &< m(\tilde{e})/GeV < 130 \ , \\
 38 &\leq m(\chi_2^0)/GeV \leq \min [1.12m(\tilde{e})/GeV - 37, 95 + 0.17m(\chi_1^0)/GeV] \ , \\
 m(\chi_1^0)/GeV &\leq m(\chi_2^0)/GeV \leq \min [1.4m(\tilde{e})/GeV - 105, 1.6m(\chi_2^0)/GeV - 60] \ .
 \end{aligned}
 \tag{11.3.4}$$

4. Sfermion production rate depends only on masses of the sfermions, so that slepton production cross section decouples from the analysis of particular scenarios. The cross section is at the level of  $\sigma = 10$  fb and consistent with data (one event!). The parameters of MSSM are super-symmetric soft-breaking parameters, super-potential parameters, and the parameter  $\tan(\beta)$ . This allows to derive more stringent limits on the masses and parameters of MSSM.

Consider now the explanation of the event in TGD framework.

1. By the properties of super-partners the production rate for  $\tilde{e}^- \tilde{e}^+$  is predicted to be same as in MSSM for  $\tilde{e} = e_R \bar{\nu}_R$ . Same order of magnitude is predicted also for more exotic super-partners such as  $e_L \bar{\nu}_R$  with spin 1.
2. In TGD framework it is safest to use just the kinematical bounds on the masses and p-adic length scale hypothesis. If super-symmetry breaking means same mass formula from p-adic thermodynamics but in a different p-adic mass scale,  $m(\tilde{e})$  is related by a power of  $\sqrt{2}$  to  $m(e)$ . Using  $m(\tilde{e}) = 2^{(127-k(\tilde{e}))/2} m(e)$  one finds that the mass range [80, 130] GeV allows two possible masses for selectron corresponding to  $p \simeq 2^k$ ,  $k = 91$  with  $m(\tilde{e}) = 131.1$  GeV and  $k = 92$  with  $m(\tilde{e}) = 92.7$  GeV. The bounds on  $m(Z)$  leave only the option  $m(\tilde{Z}) = m(Z) = 91.2$  GeV and  $m(\tilde{e}) = 131.1$  GeV.
3. The indirect determinations of Higgs masses from experimental data seem to converge to two different values. The first one would correspond to  $m(h) = 129$  GeV and  $k(h) = 94$  and second one to  $m(h) = 91$  GeV with  $k(h) = 95$  [K16, K46] . The fact that already the TGD counterpart for the Gell-Mann-Okubo mass formula in TGD framework requires quarks to exist at several p-adic mass scales [K46] , suggests that Higgs can exist in both of these mass scales depending on the experimental situation. The mass of Higgsino would correspond to some half octave of  $m(h)$ . Note that the model allows to conclude that Higgs indeed exists also in TGD Universe although it does not seem to play the same role in particle massivation as in the standard model. The bounds allow only  $k(\tilde{h}) = k(h) + 3 = 97$  and  $m(\tilde{h}) = 45.6$  GeV for  $m(h) = 129$  GeV . The same mass is obtained for  $m(h) = 91$  GeV. Therefore the kinematic limits plus super-symmetry breaking at the level of p-adic mass scale fix completely the masses of the super-particles involved in absence of mixing effects for sneutralinos. To sum up, the masses of particles involved are predicted to be

$$m(\tilde{e}) = 131 \text{ GeV} \ , \ m(\tilde{Z}^0) = 91.2 \text{ GeV} \ , \ m(\tilde{h}) = 45.6 \text{ GeV} \ .
 \tag{11.3.5}$$

## 11.4 Octo-twistors and modified Dirac equation

Classical number fields define one vision about quantum TGD which has unexpected connection also with the problem of defining twistors in terms of octonionic analog of the Clifford algebra which serves as alternative for standard Clifford algebra in this dimension. The vision about quantum TGD has evolved gradually and involves several speculative ideas.

1. The hard core of the vision is that space-time surfaces as preferred extremals of Kähler action can be identified as what I have called hyper-quaternionic surfaces of  $M^8$  or  $M^4 \times CP_2$ . This requires only the mapping of the modified gamma matrices to octonions or to a basis of subspace of complexified octonions. This means also the mapping of spinors to octonionic spinors. There is no need to assume that imbedding space-coordinates are octonionic.
2. I have considered also the idea that quantum TGD might emerge from the mere associativity.
  - (a) Consider Clifford algebra of WCW. Treat "vibrational" degrees of freedom in terms second quantized spinor fields and add center of mass degrees of freedom by replacing 8-D gamma matrices with their octonionic counterparts - which can be constructed as tensor products of octonions providing alternative representation for the basis of 7-D Euclidian gamma matrix algebra - and of 2-D sigma matrices. Spinor components correspond to tensor products of octonions with 2-spinors: different spin states for these spinors correspond to leptons and baryons.
  - (b) Construct a local Clifford algebra by considering Clifford algebra elements depending on point of  $M^8$  or  $H$ . The octonionic 8-D Clifford algebra and its local variant are non-associative. Associative sub-algebra of 8-D Clifford algebra is obtained by restricting the elements so any quaternionic 4-plane. Doing the same for the local algebra means restriction of the Clifford algebra valued functions to any 4-D hyper-quaternionic sub-manifold of  $M^8$  or  $H$  which means that the gamma matrices span complexified quaternionic algebra at each point of space-time surface. Also spinors must be quaternionic.
  - (c) The assignment of the 4-D gamma matrix sub-algebra at each point of space-time surface can be done in many manners. If the gamma matrices correspond to the tangent space of space-time surface, one obtains just induced gamma matrices and the standard definition of quaternionic sub-manifold. In this case induced 4-volume is taken as the action principle. If Kähler action defines the space-time dynamics, the modified gamma matrices do not span the tangent space in general.
  - (d) An important additional element is involved. If the  $M^4$  projection of the space-time surface contains a preferred subspace  $M^2$  at each point, the quaternionic planes are labeled by points of  $CP_2$  and one can equivalently regard the surfaces of  $M^8$  as surfaces of  $M^4 \times CP_2$  (number-theoretical "compactification"). This generalizes:  $M^2$  can be replaced with a distribution of planes of  $M^4$  which integrates to a 2-D surface of  $M^4$  (for instance, for string like objects this is necessarily true). The presence of the preferred local plane  $M^2$  corresponds to the fact that octonionic spin matrices  $\Sigma_{AB}$  span 14-D Lie-algebra of  $G_2 \subset SO(7)$  rather than that 28-D Lie-algebra of  $SO(7, 1)$  whereas octonionic imaginary units provide 7-D fundamental representation of  $G_2$ . Also spinors must be quaternionic and this is achieved if they are created by the Clifford algebra defined by induced gamma matrices from two preferred spinors defined by real and preferred imaginary octonionic unit. Therefore the preferred plane  $M^3 \subset M^4$  and its local variant has direct counterpart at the level of induced gamma matrices and spinors.
  - (e) This framework implies the basic structures of TGD and therefore leads to the notion of world of classical worlds (WCW) and from this one ends up with the notion WCW spinor field and WCW Clifford algebra and also hyper-finite factors of type  $II_1$  and  $III_1$ . Note that  $M^8$  is exceptional: in other dimensions there is no reason for the restriction of the local Clifford algebra to lower-dimensional sub-manifold to obtain associative algebra.
3. I have used time also to wilder speculations inspired by the idea that one could treat imbedding space coordinates or space-time coordinate as single hyper-octonionic or hyper-quaternionic coordinate but this line of approach has not led to anything really interesting. For instance, I have considered the generalization of conformal fields by replacing complex coordinate  $z$  with complexified octonionic coordinate of  $M^8$  to obtain a generalization of configuration space spinor fields and Clifford algebra elements to octonion-conformal fields. The dependence of the modes of the octonion-conformal field on  $M^4$  coordinates seems however non-physical (one would expect plane waves instead of powers) so that this approach does not seem promising.

The above line of ideas leads naturally to (hyper-)quaternionic sub-manifolds and to basic quantum TGD (note that the "hyper" is un-necessary if one accepts just the notion of quaternionic sub-manifold formulated in terms of modified gamma matrices). One can pose some further questions.

1. Quantum TGD reduces basically to the second quantization of the induced spinor fields. Could it be that the theory is integrable only for 4-D hyper-quaternionic space-time surfaces in  $M^8$  (equivalently in  $M^4 \times CP_2$ ) in the sense than one can solve the modified Dirac equation exactly only in these cases?
2. The construction of quantum TGD -including the construction of vacuum functional as exponent of Kähler function reducing to Kähler action for a preferred extremal - should reduce to the modified Dirac equation defined by Kähler action. Could it be that the modified Dirac equation can be solved exactly only for Kähler action.
3. Is it possible to solve the modified Dirac equation for the octonionic gamma matrices and octonionic spinors and map the solution as such to the real context by replacing gamma matrices and sigma matrices with their standard counterparts? Could the associativity conditions for octospinors and modified Dirac equation allow to pin down the form of solutions to such a high degree that the solution can be constructed explicitly?
4. Octonionic gamma matrices provide also a non-associative representation for 8-D version of Pauli sigma matrices and encourage the identification of 8-D twistors as pairs of octonionic spinors conjectured to be highly relevant also for quantum TGD. Does the quaternionicity condition imply that octo-twistors reduce to something closely related to ordinary twistors as the fact that 2-D sigma matrices provide a matrix representation of quaternions suggests?

In the following I will try to answer these questions by developing a detailed view about the octonionic counterpart of the modified Dirac equation and proposing explicit solution ansätze for the modes of the modified Dirac equation.

#### 11.4.1 The replacement of $SO(7, 1)$ with $G_2$

The basic implication of octonionization is the replacement of  $SO(7, 1)$  as the structure group of spinor connection with  $G_2$ . This has some rather unexpected consequences.

##### Octonionic representation of 8-D gamma matrices

Consider first the representation of 8-D gamma matrices in terms of tensor products of 7-D gamma matrices and 2-D Pauli sigma matrices.

1. The gamma matrices are given by

$$\gamma^0 = 1 \times \sigma_1 \quad , \quad \gamma^i = \gamma^i \otimes \sigma_2 \quad , \quad i = 1, \dots, 7 \quad . \quad (11.4.1)$$

7-D gamma matrices in turn can be expressed in terms of 6-D gamma matrices by expressing  $\gamma^7$  as

$$\gamma_{i+1}^{(7)} = \gamma_i^{(6)} \quad , \quad i = 1, \dots, 6 \quad , \quad \gamma_1^{(7)} = \gamma_7^{(6)} = \prod_{i=1}^6 \gamma_i^{(6)} \quad . \quad (11.4.2)$$

2. The octonionic representation is obtained as

$$\gamma_0 = 1 \times \sigma_1 \quad , \quad \gamma_i = e_i \otimes \sigma_2 \quad . \quad (11.4.3)$$

where  $e_i$  are the octonionic units.  $e_i^2 = -1$  guarantees that the  $M^4$  signature of the metric comes out correctly. Note that  $\gamma_7 = \prod \gamma_i$  is the counterpart for choosing the preferred octonionic unit and plane  $M^2$ .

3. The octonionic sigma matrices are obtained as commutators of gamma matrices:

$$\Sigma_{0i} = e_i \times \sigma_3 \quad , \quad \Sigma_{ij} = f_{ij}{}^k e_k \otimes 1 \quad . \quad (11.4.4)$$

These matrices span  $G_2$  algebra having dimension 14 and rank 2 and having imaginary octonion units and their conjugates as the fundamental representation and its conjugate. The Cartan algebra for the sigma matrices can be chosen to be  $\Sigma_{01}$  and  $\Sigma_{23}$  and belong to a quaternionic sub-algebra.

4. The lower dimension of the  $G_2$  algebra means that some combinations of sigma matrices vanish. All left or right handed generators of the algebra are mapped to zero: this explains why the dimension is halved from 28 to 14. From the octonionic triangle expressing the multiplication rules for octonion units [?] one finds  $e_4 e_5 = e_1$  and  $e_6 e_7 = -e_1$  and analogous expressions for the cyclic permutations of  $e_4, e_5, e_6, e_7$ . From the expression of the left handed sigma matrix  $I_L^3 = \sigma_{23} + \sigma^{30}$  representing left handed weak isospin (see the Appendix of the book about the geometry of  $CP_2$ ) one can conclude that this particular sigma matrix and left handed sigma matrices in general are mapped to zero. The quaternionic sub-algebra  $SU(2)_L \times SU(2)_R$  is mapped to that for the rotation group  $SO(3)$  since in the case of Lorentz group one cannot speak of a decomposition to left and right handed subgroups. The elements of the complement of the quaternionic sub-algebra are expressible in terms of  $\Sigma_{ij}$  in the quaternionic sub-algebra.

### Some physical implications of $SO(7,1) \rightarrow G_2$ reduction

This has interesting physical implications if one believes that the octonionic description is equivalent with the standard one.

1. Since  $SU(2)_L$  is mapped to zero only the right-handed parts of electro-weak gauge field survive octonization. The right handed part is neutral containing only photon and  $Z^0$  so that the gauge field becomes Abelian.  $Z^0$  and photon fields become proportional to each other ( $Z^0 \rightarrow \sin^2(\theta_W)\gamma$ ) so that classical  $Z^0$  field disappears from the dynamics, and one would obtain just electrodynamics. This might provide a deeper reason for why electrodynamics is an excellent description of low energy physics and of classical physics. This is consistent with the fact that  $CP_2$  coordinates define 4 field degrees of freedom so that single Abelian gauge field should be enough to describe classical physics. This would remove also the interpretational problems caused by the transitions changing the charge state of fermion induced by the classical  $W$  boson fields.

Also the realization of  $M^8 - H$  duality led to the conclusion  $M^8$  spinor connection should have only neutral components. The isospin matrix associated with the electromagnetic charge is  $e_1 \times 1$  and represents the preferred imaginary octonionic unit so that that the image of the electro-weak gauge algebra respects associativity condition. An open question is whether octonization is part of  $M^8$ -H duality or defines a completely independent duality. The objection is that information is lost in the mapping so that it becomes questionable whether the same solutions to the modified Dirac equation can work as a solution for ordinary Clifford algebra.

2. The gauge potentials and gauge fields defined by  $CP_2$  spinor connection are mapped to fields in  $SO(2) \subset SU(2) \times U(1)$  in quaternionic sub-algebra which in a well-defined sense corresponds to  $M^4$  degrees of freedom! Since the resulting interactions are of gravitational character, one might say that electro-weak interactions are mapped to manifestly gravitational interactions. Since  $SU(2)$  corresponds to rotational group one cannot say that spinor connection would give rise only to left or right handed couplings, which would be obviously a disaster.

### Octo-spinors and their relation to ordinary imbedding space spinors

Octo-spinors are identified as octonion valued 2-spinors with basis

$$\begin{aligned} \Psi_{L,i} &= e_i \begin{pmatrix} 1 \\ 0 \end{pmatrix} , \\ \Psi_{q,i} &= e_i \begin{pmatrix} 0 \\ 1 \end{pmatrix} . \end{aligned} \tag{11.4.5}$$

One obtains quark and lepton spinors and conjugation for the spinors transforms quarks to leptons. Note that octospinors can be seen as 2-dimensional spinors with components which have values in the space of complexified octonions.

The leptonic spinor corresponding to real unit and preferred imaginary unit  $e_1$  corresponds naturally to the two spin states of the right handed neutrino. In quark sector this would mean that right handed U quark corresponds to the real unit. The octonions decompose as  $1 + 1 + 3 + \bar{3}$  as representations of  $SU(3) \subset G_2$ . The concrete representations are given by

$$\begin{aligned} \{1 \pm ie_1\} &, \quad e_R \text{ and } \nu_R \text{ with spin } 1/2 , \\ \{e_2 \pm ie_3\} &, \quad e_R \text{ and } \nu_L \text{ with spin } -1/2 , \\ \{e_4 \pm ie_5\} &, \quad e_L \text{ and } \nu_L \text{ with spin } 1/2 , \\ \{e_6 \pm ie_7\} &, \quad e_L \text{ and } \nu_L \text{ with spin } 1/2 . \end{aligned} \tag{11.4.6}$$

Instead of spin one could consider helicity. All these spinors are eigenstates of  $e_1$  (and thus of the corresponding sigma matrix) with opposite values for the sign factor  $\epsilon = \pm$ . The interpretation is in terms of vectorial isospin. States with  $\epsilon = 1$  can be interpreted as charged leptons and D type quarks and those with  $\epsilon = -1$  as neutrinos and U type quarks. The interpretation would be that the states with vanishing color isospin correspond to right handed fermions and the states with non-vanishing SU(3) isospin (to be not confused with QCD color isospin) and those with non-vanishing SU(3) isospin to left handed fermions. The only difference between quarks and leptons is that the induced Kähler gauge potentials couple to them differently.

The importance of this identification is that it allows a unique map of the candidates for the solutions of the octonionic modified Dirac equation to those of ordinary one. There are some delicacies involved due to the possibility to chose the preferred unit  $e_1$  so that the preferred subspace  $M^2$  can corresponds to a sub-manifold  $M^2 \subset M^4$ .

### 11.4.2 Octonionic counterpart of the modified Dirac equation

The solution ansatz for the octonionic counterpart of the modified Dirac equation discussed below makes sense also for ordinary modified Dirac equation which raises the hope that the same ansatz, and even same solution could provide a solution in both cases.

#### The general structure of the modified Dirac equation

There are two options concerning measurement interaction corresponding to  $D_4 = D_K + Q_K$  and  $D_3 = D_{C-S} + Q_{C-S}$ . Here only the option based on  $D_K + Q_K$  is discussed since it looks more promising.

For  $D_K + Q_K$  option there is only single equation and corresponds to a 4-D modified Dirac equation defined by Kähler action with measurement interaction term:

$$(D_K + Q_K)\Psi = 0 . \tag{11.4.7}$$

Also a CP-breaking instanton could be considered. In absence of measurement interaction the dimensional reduction of this operator to a sum corresponding to  $D_{K,3}$  acting on light-like 3-surfaces and 1-D operator  $D_{K,1}$  acting on the coordinate labeling the 3-D light-like 3-surfaces in the slicing allows to assign eigenvalues to  $D_{K,3}$  as analogs of energy eigenvalues for ordinary Schrödinger equation. It is not clear whether similar reduction occurs also in presence of measurement interaction. Dirac determinant is identified as the product of these eigen values of  $D_{K,3} + Q_K$ .

### About the hyper-octonionic variant of the modified Dirac equation

What gives excellent hopes that the octonionic variant of modified Dirac equation could lead to a provide precise information about the solution spectrum of modified Dirac equation is the condition that everything in the equation should be associative. Hence the terms which are by there nature non-associative should vanish automatically. First some general comments.

1. The first implication is that the besides octonionic gamma matrices also octonionic spinors should belong to the local quaternionic plane at each point of the space-time surface. Spinors are also generated by quaternionic Clifford algebra from two preferred spinors defining a preferred plane in the space of spinors. Hence spinorial dynamics seems to mimic very closely the space-time dynamics and one might even hope that the solutions of the modified Dirac action could be seen as maps of the space-time surface to surfaces of the spinor space. The reduction to quaternionic sub-algebra suggest that some variant of ordinary twistors emerges in this manner in matrix representation.
2. The octonionic sigma matrices span  $G_2$  where as ordinary sigma matrices define  $SO(7,1)$ . On the other hand, the holonomies are identical in the two cases if right-handed charge matrices are mapped to zero so that there are indeed hopes that the solutions of the octonionic Dirac equation cannot be mapped to those of ordinary Dirac equation. If left-handed charge matrices are mapped to zero, the resulting theory is essentially the analog of electrodynamics coupled to gravitation at classical level but it is not clear whether this physically acceptable. It is not clear whether associativity condition leaves only this option under consideration.
3. The condition  $D^2\Psi = 0$  with  $D = (D_K + Q_K)$  involves products of three octonions and derivatives of the modified gamma matrices which can belong to the complement of the quaternionic sub-space. Therefore  $(D^2)D\Psi_i = D(D^2\Psi_i)$  could fail. It is not clear whether the failure of this condition is a catastrophe.

For the measurement interaction defined by Kähler action situation is very simple since commutator condition is not needed. The solution ansatz to the modified Dirac equation with interaction term is expected to be of the form  $\Psi = (D_K + Q_K)(\Psi_0 u_0 + \Psi_1 u_1)$ , where  $u_0$  and  $u_1$  are constant spinors representing real unit and the preferred unit  $e_1$ . Hence constant spinors associated with right handed electron and neutrino and right-handed d and u quark would appear in  $\Psi$  and  $\Psi_i$  could correspond to scalar coefficients of spinors with different charge. This ansatz would reduce the modified Dirac equation to  $(D_K + Q_K)^2\Psi_i = 0$  since there are no charged couplings present. The reduction of a d'Alembert type equation for single scalar function coupling to  $U(1)$  gauge potential and  $U(1)$  "gravitation" would obviously mean a dramatic simplification raising hopes about integrable theory.

### General features of the solution ansatz

The solution ansätze for Chern-Simons and Kähler option have some common features.

1. In both cases one must eliminate  $Q_K$  from the equation. The function  $\Phi_i$  -call it just  $\Phi$  - is proportional to a function, which is a generalization of plane wave and guarantees that Kähler Dirac equation is satisfied:

$$U_Q = \exp(i\Phi_Q) , \quad \Phi_Q = \int_{\gamma_{4,1}} Q_{K,\alpha} dx^\alpha . \quad (11.4.8)$$

Here the curves  $\gamma_{4,1}$  can be chosen rather freely since integrable phase factor is in question.  $\gamma_{4,1}$  can be chose so that it defines a slicing of  $X^4$  reducing to a union of the slicings of  $Y_l^3$ . The stringy slicing of  $X^4$  encourages the identification of these curves as the ends of the orbits of strings connecting different wormhole throats. For four-momentum this expression reduces to a plane wave.



2. In both cases one must eliminate the covariant derivatives from the modified Dirac equation. For the Abelian option the non-integrable phase factor is defined by the Abelian induced spinor connection and eliminates the coupling to gauge potentials in the modified Dirac equation. By abelianity these factors reduce to ordinary integrals:

$$U_{A,i} = \exp\left(i \int_{\gamma_{4,i}} A_\alpha dx^\alpha\right) \equiv \exp(i\Phi_{A,i}) \ , \ i = 1, 2 \ . \quad (11.4.9)$$

The two families of curves denoted by  $\gamma_{4,i}$  correspond to stringy curves and the curves defined by their ends. The phase factors are actually diagonal  $2 \times 2$  matrix since  $A$  involves a coupling to spin. In octonionic case the Abelian phase factor is actually diagonal  $2 \times 2$  matrix since  $A$  involves a coupling to spin.

#### The detailed form of the modified Dirac-Kähler equation for Kähler option

$\hat{\Gamma}^u = \hat{\Gamma}^v$  implies the degeneracy of the effective metric so that one has  $\hat{g}^{u\alpha} = \hat{g}^{v\alpha}$ . This simplifies the equation to an effectively 2-dimensional form.

1. The integrable phase factor  $\exp(\Phi_Q)$  and non-integrable phase factors  $\exp(\Phi_{A,i})$  are present also now.
2. The general form of the solution ansatz for Kähler option differs slightly from that for Chern-Simons option since one can assume plane waves in both directions but with different "energies".

$$U_{\lambda_1, \lambda_2} = \exp(i\lambda_1 u) \exp(i\lambda_2 v) \equiv \exp(i\Phi_{\lambda_1}) \exp(i\Phi_{\lambda_2}) \ . \quad (11.4.10)$$

3. In the recent case the factor  $R$  depends only on the transversal coordinates associated with the partonic 2-surfaces, and is analogous to oscillator wave function in an external magnetic field at  $X^2$  defined by the Abelian gauge field.
4. One can write the solution ansatz in the form

$$\Psi = (D_K + Q_K)\Psi_i = \left[ \frac{D_{K,2}R}{R} + \hat{\Gamma}^u (\partial_u \Phi_Q + \partial_u \Phi_{A,1} + \partial_v \Phi_{A,2} + \lambda_1 + \lambda_2) \right] \Psi_i \ . \quad (11.4.11)$$

Here  $D_{K,2}$  represents 2-dimensional dimensional reduction of  $D_K$  acting at partonic 2-surface.

5. Without further assumptions it is not possible get rid of the non-integrable phase factors completely. The sum of the derivatives of non-integrable phase factors characterizes the change of the Kähler magnetic flux through a surface defined by 2 parallel stringy curves and 2 parallel string end curves as second stringy curve and string end curve meeting at the point considered are shifted slightly. The condition allowing to get rid of these derivatives reads as

$$J_{tu} = 0 \ . \quad (11.4.12)$$

The condition states that there is no Kähler electric field component along string orbits so that the strings would behave like conductors. Note that this condition generalizes also to non-Abelian case (non-octonionic gamma matrices). Effective 3-dimensionality suggests that also  $\Phi_Q$  is constant along stringy curves.

With these optimistic assumptions the ansatz would reduce to

$$\Psi = (D_K + Q_K)\Psi_i = \left[ \frac{D_{K,2}R}{R} + \hat{\Gamma}^u(\lambda_1 + \lambda_2) \right] \Psi_i . \quad (11.4.13)$$

6. Continuing in the same optimistic spirit the modified Dirac equation reduces to

$$\begin{aligned} (D_K + Q_K)(D_K + Q_K)\Psi_i &= (D_K + Q_K) \left[ \frac{D_{K,2}R}{R} + \hat{\Gamma}^u(\lambda_1 + \lambda_2) \right] \Psi_i \\ &= \left[ \frac{D_{K,2}^2R}{R} + (\hat{\Gamma}^u)^2(\lambda_1 + \lambda_2)^2 + [D_K, \hat{\Gamma}^u](\lambda_1 + \lambda_2) \right] \Psi_i . \end{aligned} \quad (11.4.14)$$

Since  $R$  depends only on the two transversal coordinates, one obtains equation analogous to a 2-dimensional Schrödinger equation in 2-D magnetic field and quantization of  $\lambda_1 + \lambda_2$  is expected. In the octonionic picture the magnetic field is Abelian so that the analogy is rather concrete. If the region surrounding the wormhole throat has boundary, only finite number of eigen-modes are expected. If a string-like object is in question there is no boundary so that the number of eigenvalues can be infinite. This means homological non-triviality and Kähler magnetic charge so that a string carrying magnetic monopoles at its ends is in question.

7. The quantization of  $\lambda_i$  ought to have a description in terms of the analogy with the harmonic oscillator wave functions for a charged particle in an external Abelian magnetic field.  $\lambda_1 - \lambda_2$  could be determined by the boundary conditions.  $\lambda_1 = \lambda_2$  is suggested by the duality of the slicing defined by stringy curves and by string end curves.

To sum up, the solution ansatz is very simple for Kähler option provided that the induced Kähler form (more generally, induced electro-weak gauge field) vanishes in  $(u, v)$  planes and the generalized plane-waves  $\exp(i\Phi_Q)$  are constant along the stringy curves as the effective 3-dimensionality and light-likeness of these curves suggests. For the dual solution ansatz  $\exp(i\Phi_Q)$  would be constant along the string end curves. These ansätze are analogs of plane waves with opposite wave vectors but same frequency.

### 11.4.3 Could the notion of octo-twistor make sense?

The basic problem of the twistor program is how to overcome the difficulties caused by particle massivation and TGD framework suggests possible clues in this respect.

1. In TGD framework it is natural to regard particles as massless particles in 8-D sense and to introduce 8-D counterpart of twistors by relying on the geometric picture in which twistors correspond to a pair of spinors characterizing light-like momentum ray and a point of  $M^8$  through which the ray traverses. Twistors would consist of a pair of spinors and quark and lepton spinors define the natural candidate for the spinors in question.
2. In the case of ordinary Clifford algebra unit matrix and six-dimensional gamma matrices  $\gamma_i$ ,  $i = 1, \dots, 6$  and  $\gamma_7 = \prod_i \gamma_i$  would define the variant of Pauli sigma matrices as  $\sigma_0 = 1$ ,  $\sigma_k = \gamma_k$ ,  $k = 1, \dots, 7$ . The problem is that masslessness condition does not correspond to the vanishing of the determinant for the matrix  $p_k \sigma^k$ .
3. In the case of octo-twistors Pauli sigma matrices  $\sigma^k$  would correspond to hyper-octonion units  $\{\sigma_0, \sigma_k\} = \{1, ie^k\}$  and one could assign to  $p_k \sigma^k$  a matrix by the linear map defined by the multiplication with  $P = p_k \sigma^k$ . The matrix is of form  $P_{mn} = p^k f_{kmn}$ , where  $f_{kmn}$  are the structure constants characterizing multiplication by hyper-octonion. The norm squared for octonion is the fourth root for the determinant of this matrix. Since  $p_k \sigma^k$  maps its octonionic

conjugate to zero so that the determinant must vanish (as is easy to see directly by reducing the situation to that for hyper-complex numbers by considering the hyper-complex plane defined by  $P$ ).

4. The associativity of octo-twistors means that the momentum like quantity and the two spinors belong to the same complex quaternionic plane. This suggests that octo-twistor can be mapped to an ordinary twistor by mapping the basis of hyper-quaternions to Pauli sigma matrices. Quaternionization would also allow to assign to momentum to the spinors in standard manner.

One can consider two approaches to the notion of octo-twistor: global and local.

1. The global approach to the notion of octo-twistor starts from four-momentum and color charges combined to form an 8-vector. Associativity requires that both the momentum and the spinors defining the twistors are in the same quaternionic plane which suggests that 8-D twistors reduce to 4-D twistors. In the case of  $M^8$  and assuming 8-momenta, this difficulty can be overcome if fixed  $M^4 \subset M^8$  defines Minkowski momentum. In the case of  $M^4 \times CP_2$  one can assign to light-like geodesics light-like 8-momentum in terms of the tangent vector to a light-like geodesic line reducing to circle in  $CP_2$ . In quantum theory color isospin and hypercharge would be the counterparts of  $CP_2$  momentum. In this case the geometric condition assigning to the light-like ray a position assignable to light-cone boundary of  $M^8$  in second light-cone boundary of  $M^8$  requires  $M^8 - H$  duality. The objection against this approach is that it is stringy propagator which should fix the notion of twistor used.
2. The second approach is local and replaces 8-momentum with the charge vector  $Q_\alpha$  appearing in the stringy propagator belonging to the local hyper-quaternionic plane of the space-time surface by the associativity condition. Local twistorialization would be based on  $Q_\alpha$ , which together with the leptonic and quark-like spinors should belong to the local quaternionic sub-space. This means four complex components for both spinors and four components for real components for  $Q_\alpha$ . The defining equation would read in this case be

$$Q_{i\alpha} = \bar{\Psi}_i \hat{\Gamma}_\alpha \Psi_i . \tag{11.4.15}$$

Here  $i = q, L$  refers to leptonic/quark-like spinor. These conditions would hold true separately for quark-like and lepton like charge vectors since quark and lepton currents are separately conserved.

The experience with the ordinary twistors and the requirement that local octo-twistors can be mapped to ordinary twistors suggest that one should consider the condition

$$g_K^{\alpha\beta} Q_{i\alpha} Q_{i\beta} = 0 \tag{11.4.16}$$

as a generalization of the masslessness condition. Here  $g_K$  is the effective metric defined by the anti-commutator of the modified gamma matrices defined by C-S action or Kähler action. One can hope that this condition is consistent with the vanishing of the commutator  $[D_K, D_3]$  giving already 8 conditions. If the dynamics of Kähler action manages to make massive particles effectively massless, a local twistor description in essentially 4-dimensional sense would be possible by the effective metric defined by modified gamma matrices and the construction of local twistors would reduce to standard recipes.

## 11.5 SUSY algebra of fermionic oscillator operators and WCW local Clifford algebra elements as super-fields

Whether TGD allows space-time supersymmetry has been a long-standing question. Majorana spinors appear in  $N = 1$  super-symmetric QFTs- in particular minimally super-symmetric standard model

(MSSM). Majorana-Weyl spinors appear in M-theory and super string models. An undesirable consequence is chiral anomaly in the case that the numbers of left and right handed spinors are not same. For  $D = 11$  and  $D = 10$  these anomalies cancel which led to the breakthrough of string models and later to M-theory. The probable reason for considering these dimensions is that standard model does not predict right-handed neutrino (although neutrino mass suggests that right handed neutrino exists) so that the numbers of left and right handed Weyl-spinors are not the same.

In TGD framework the situation is different. Covariantly constant right-handed neutrino spinor acts as a super-symmetry in  $CP_2$ . One might think that right-handed neutrino in a well-defined sense disappears from the spectrum as a zero mode so that the number of right and left handed chiralities in  $M^4 \times CP_2$  would not be same. For light-like 3-surfaces covariantly constant right-handed neutrino does not however solve the counterpart of Dirac equation for a non-vanishing four-momentum and color quantum numbers of the physical state. Therefore it does not disappear from the spectrum anymore and one expects the same number of right and left handed chiralities.

In TGD framework the separate conservation of baryon and lepton numbers excludes Majorana spinors and also the the Minkowski signature of  $M^4 \times CP_2$  makes them impossible. The conclusion that TGD does not allow super-symmetry is however wrong. For  $\mathcal{N} = 2N$  Weyl spinors are indeed possible and if the number of right and left handed Weyl spinors is same super-symmetry is possible. In 8-D context right and left-handed fermions correspond to quarks and leptons and since color in TGD framework corresponds to  $CP_2$  partial waves rather than spin like quantum number, also the numbers of quark and lepton-like spinors are same.

The physical picture suggest a new kind of approach to super-symmetry in the sense that the anti-commutations of fermionic oscillator operators associated with the modes of the induced spinor fields define a structure analogous to SUSY algebra. This means that  $\mathcal{N} = 2N$  SUSY with large  $N$  is in question allowing spins higher than two and also large fermion numbers. Recall that  $\mathcal{N} \leq 32$  is implied by the absence of spins higher than two and the number of real spinor components is  $N = 32$  also in TGD. The situation clearly differs from that encountered in super-string models and SUSYs and the large value of  $N$  allows to expect very powerful constraints on dynamics irrespective of the fact that SUSY is broken. Right handed neutrino modes define a sub-algebra for which the SUSY is only slightly broken by the absence of weak interactions and one could also consider a theory containing a large number of  $\mathcal{N} = 2$  super-multiplets corresponding to the addition of right-handed neutrinos and antineutrinos at the wormhole throat.

Masslessness condition is essential for super-symmetry and at the fundamental level it could be formulated in terms of modified gamma matrices using octonionic representation and assuming that they span local quaternionic sub-algebra at each point of the space-time sheet. SUSY algebra has standard interpretation with respect to spin and isospin indices only at the partonic 2-surfaces so that the basic algebra should be formulated at these surfaces. Effective 2-dimensionality would require that partonic 2-surfaces can be taken to be ends of any light-like 3-surface  $Y_I^3$  in the slicing of the region surrounding a given wormhole throat.

### 11.5.1 Super-algebra associated with the modified gamma matrices

Anti-commutation relations for fermionic oscillator operators associated with the induced spinor fields are naturally formulated in terms of the modified gamma matrices. Super-conformal symmetry suggests that the anti-commutation relations for the fermionic oscillator operators at light-like 3-surfaces or at their ends are most naturally formulated as anti-commutation relations for SUSY algebra. The resulting anti-commutation relations would fix the quantum TGD. Lepton and quark like spinors are now the counterparts of right and left handed Weyl spinors. Spinors with dotted and un-dotted indices correspond to conjugate representations of  $SO(3, 1) \times SU(4)_L \times SU(2)_R$ . The anti-commutation relations make sense for sigma matrices identified as 6-dimensional matrices  $1_6, \gamma_7, \gamma_1, \dots, \gamma_6$ .

In leptonic sector one would have the anticommutation relations

$$\begin{aligned} \{a_{m\dot{\alpha}}^\dagger, a_\beta^n\} &= 2\delta_m^n D_{\dot{\alpha}\beta} \ , \\ D &= (p_\mu + \sum_a Q_\mu^a) \sigma^\mu \ . \end{aligned} \quad (11.5.1)$$

In quark sector  $\sigma^\mu$  is replaced with  $\bar{\sigma}^\mu$  obtained by changing the signs of space-like sigma matrices.  $p_\mu$  and  $Q_\mu^a$  are the projections of momentum and color charges in Cartan algebra to the space-time

surface. The action of these charges is on the position of the tip of  $CD$  and therefore purely algebraic as far as space-time coordinates are considered. The anti-commutation relations define a generalization of the ordinary equal-time anticommutation relations for fermionic oscillator operators to a manifestly covariant form. Extended SUSY algebra suggest that the anti-commutators could contain additional central charge term proportional to  $\delta_{\alpha\beta}$  but the 8-D chiral invariance excludes this term.

In the octonionic representation of the sigma matrices matrix indices cannot be present at the right handed side without additional conditions. Octonionic units however allow a representation as matrices defined by the structure constants failing only when products of more than two octonions are considered. For the quaternionic sub-algebra this does not occur. Both spinor modes and gamma matrices must belong to the local hyper-quaternionic sub-algebra. Octonionic representation reduces  $SO(7, 1)$  so  $G_2$  as a tangent space group. Similar reduction for 7-dimensional compact space takes place also M-theory.

One can consider basically two different options concerning the definition of the super-algebra. If the super-algebra is defined at the 3-D ends of the intersection of  $X^4$  with the boundaries of  $CD$ , the modified gamma matrices appearing in the operator  $D$  appearing in the anti-commutator are associated with Kähler action. If the generalized masslessness condition  $D^2 = 0$  holds true -as suggested already earlier- one can hope that no explicit breaking of super-symmetry takes place and elegant description of massive states as effectively massless states making also possible generalization of twistor is possible. One must however notice that also massive representatives of SUSY exist. SUSY algebra could be also defined at 2-D ends of light-like 3-surfaces. According to considerations of [?] these options are equivalent if the effective metric defined by the modified gamma matrices is degenerate so that space-time sheet is effectively 3-dimensional. In this case propagation takes place along 3-D light-like 3-surfaces. This condition fails for string like objects.

One can realize the local Clifford algebra in terms of super fields by introducing theta parameters in the standard manner and the expressing a collection of local Clifford algebra element with varying values of fermion numbers (function of  $CD$  and  $CP_2$  coordinates) as a chiral super-field. The definition of a chiral super field requires the introduction of super-covariant derivatives.

Standard form for the anti-commutators of super-covariant derivatives  $D_\alpha$  make sense only if the momentum and color charges do not act as differential operators acting on space-time coordinates and thus affecting the modified gamma matrices. This is achieved since  $p_k$  and  $Q_a$  act on the position of the tip of  $CD$  in  $M^4 \times CP_2$  (rather than internal coordinates of the space-time sheet).

### 11.5.2 Super-fields associated with WCW Clifford algebra

WCW local Clifford algebra elements possess definite fermion numbers and it is not physically sensible to super-pose local Clifford algebra elements with different fermion numbers. The extremely elegant formulation of super-symmetric theories in terms of super-fields encourages to ask whether the local Clifford algebra elements could allow expansion in terms of complex theta parameters assigned to various fermionic oscillator operator in order to obtain formal superposition of elements with different fermion numbers. One can also ask whether the notion of chiral super field might make sense.

The obvious question is whether it makes sense to assign super-fields with the modified gamma matrices.

1. As already noticed, modified gamma matrices are not covariantly constant but this is not a problem since the action of momentum generators and color generators space-time coordinates is purely algebraic.
2. One can define the notion of super-field also at the fundamental level. Chiral super-field would be continuation of the local Clifford algebra of associated with  $CD$  to a local Clifford algebra element associated with the union of  $CD$ s. This would allow elegant description of cm degrees of freedom, which are the most interesting as far as QFT limit is considered.
3. In particular, the Kähler function of WCW as a function of complex coordinates can be extended to a chiral super-field defined in quantum fluctuation degrees of freedom. It would depend on zero modes too. Does also the latter dependence allow super-space continuation? Coefficients of powers of theta would correspond to fermionic oscillator operators. Does this function define the propagators of various states associated with light-like 3-surface? Configuration space complex

coordinates would correspond to the modes of induced spinor field so that super-symmetry would be realized very concretely.

4. Quantum criticality implies infinite number of conserved super-currents assignable to zero modes and it seems that similar coding makes sense also for the dependence of Kähler function on zero modes.

The really elegant feature of the super-field concept is that it allows to code the Taylor polynomial of a function at given point -essentially non-local data- to a purely local data about super field. The coding of the Taylor expansion of WCW Kähler function at maximum would represent only one example of this expansion.

The obvious idea is that the exponent of the super-space Kähler function defines the vacuum functional of the theory determining all interaction vertices. In this interpretation the scalar components  $\phi_i$  of infinite-component chiral field would correspond to complex coordinates of WCW. Also zero modes might allow super-symmetrization by using the fermionic currents implied by quantum criticality.

It is not clear whether vector super-fields make sense in this framework or are needed.

1. Zero energy ontology and the identification of gauge bosons as wormhole contacts encourage the identification of both fermions and bosons as chiral super-fields. One could assign to fermions either the positive or negative energy variant of  $\mathcal{N}$  super-algebra having possibly infinite number of generators and to bosons the direct sum of these super-algebras so that one has positive and negative energy fermions  $F_+$  and  $F_-$  with  $\mathcal{N}$  super-symmetry and bosons  $B_{+-}$  with  $(\mathcal{N}, \mathcal{N})$  super-symmetry.  $B_{+-}$  would be anti-chiral with respect to  $\theta_+$  and chiral with respect to  $\theta_-$  and hermiticity condition can be considered as an additional condition with hermitian conjugation mapping  $\theta_+$  to  $\theta_-$ . The fundamental action would reduce to the integral over  $\theta_+$  and  $\theta_-$  and their conjugates in the product of  $\bar{F}_- B_{-+} F_+$ . Gauge symmetries are consistent with this guess if realized by regarding both  $B$  and  $F$  fields are chiral super-fields. Bosonic emergence would suggest that no kinetic term is needed for bosons.
2. One can consider also the possibility of Hermitian vector field  $V$  as local Clifford algebra element by using the same basic definition as used in super-symmetric quantum field theories. The  $c$ -number part of  $V$  could be interpreted in terms of the spinor connection of WCW: this part cannot be dynamical. It is not however clear whether the definition of corresponding chiral super-field is sensible in the infinite-dimensional context. Also one can ask whether this kind of field is needed at the fundamental level since bosons and their super-partners in TGD framework are identified as pairs of wormhole throats. Super-Kähler function  $K = K(\Phi^\dagger, \Phi)$  ( $K = K(\Phi^\dagger, \exp(-V)\Phi)$ ) would be a function of chiral super-field  $\Phi$ , its conjugate  $\Phi^\dagger$  (, and vector super-field  $V$ ). A profound generalization of the physics as geometry idea would be the outcome.

At QFT limit the super fields depend on the point of  $M^4$ . The dependence on the point  $h$  of  $M^4 \times CP_2$  makes sense also in WCW context since  $h$  can be interpreted as position of the either tip of  $CD$ . A given value of  $\Phi$  at given point  $h$  of  $H$  fixes the WCW coordinates characterizing the light-like 3-surface  $X_l^3$  inside  $CD$  with tip at  $h$ . Constant values of  $\Phi$  analogous to vacuum expectation of Higgs means that  $X_l^3$  is same for all  $CD$ s. The quantum field character of  $\Phi$  codes for the fact that one has actually quantum superposition of space-time surfaces. The functional integral around a given maximum of Kähler function replaces this superposition effectively with single space-time surface.

## 11.6 SUSY algebra at QFT limit

The first expectation is that QFT limit TGD corresponds to a situation in which space-time surfaces are representable as a graph for some map  $M^4 \rightarrow CP_2$ . This assumption is not actually needed in zero energy ontology since  $M^4$  labels the positions of either tip of  $CD$  rather than points of the space-time sheet. The position of the other tip of  $CD$  relative to the first one could be interpreted in terms of Robertson-Walker coordinates for quantum cosmology [K66]. Second intuitively plausible idea is that particle space-time sheets are replaced with world-lines. Actually the replacement of partonic 2-surfaces with points is needed and even this assumption can be given up in one formulation

of QFT limit feeding information about partonic 2-surfaces to the theory. What is essential that only perturbations around single maximum of Kähler function are considered. If several maxima are important, one must include a weighting defined by the values of the exponent of Kähler function.

### 11.6.1 Minimum information about space-time sheet and particle quantum numbers needed to formulate SUSY algebra

The basic problem is how to feed just the essential information about quantum states and space-time surfaces to the definition of the QFT limit.

1. The information about quantum numbers of particles feeded to the measurement interaction must be feeded also to the QFT action. It is natural to start from the classical description of point like particles in  $H$  in terms of light-like curves of  $H$  reducing to light-like geodesic lines for free particles. Momentum and color charges serve as natural quantum numbers. The conserved color charges associated with  $CP_2$  geodesics need not correspond to the usual color charges since they correspond to center of mass rotational motion in  $CP_2$  degrees of freedom. Ordinary color charges correspond to the spinorial partial wavs assignable to  $CP_2$  type extremals.
2. Should interpreted QFT limit as a QFT in  $X^4$  representable as a graph for a map  $M^4 \rightarrow CP_2$ , or in  $M^4$ , or perhaps in  $M^4 \times CP_2$ ? In zero energy ontology the proper interpretation is in terms of QFT in  $M^4$  labeling the tips of  $CD$ s so that no restrictions on space-time sheets need to be posed. Furthermore, by quantum classical correspondence the space-time sheet surrounding given wormhole throat depends on the four-momentum assigned so that Poincare invariant theory in  $M^4$  is the only logically consistent option. Minimal extension to  $M^4 \times CP_2$  is required in order to take into account the geodesic motion in  $CP_2$  degrees of freedom.
3. What information about space-time surface is needed?
  - (a) One can in principle feed all information about space-time sheet without losing Poincare invariance since momentum operators do not act on space-time coordinates. The description becomes however in-practical even if one restricts the consideration to the maxima of Kähler function.
  - (b) The minimal approach would use only cm degrees of freedom for the tip of the  $CD$  associated with the particle and feed minimum information about light-like 3-surface inside the  $CD$ .
  - (c) The information about partonic two-surfaces  $X^2$  defined as intersections of 3-D light-like wormhole throats with the boundary of  $CD$  characterizes elementary particles, and it would be natural to feed this information to the theory by replacing  $M^4$  gamma matrices with modified gamma matrices. This would feed in also the information about hyper-quaternionicity making possible to generalize the notion of twistor. This information would be coded by the partial derivatives of the imbedding space coordinates at  $X^2$ , and would be needed only at the partonic 2-surfaces  $X^2$  defining the generalized vertices.
  - (d) Some information about zero modes characterized by the induced Kähler form invariant under quantum fluctuations assignable to Hamiltonians of  $\delta M_{\pm}^4 \times CP_2$  at boundaries of  $CD$  is certainly needed: here the identification of Kähler potential as the Kähler function of WCW is highly attractive hypothesis.

### 11.6.2 The physical picture behind the realization of SUSY algebra at point like limit

The challenge is to deduce SUSY algebra in the approximation that partonic 2-surfaces are replaced by points. The basic physical constraint on the realization of the SUSY algebra come from the condition that one must be able to describe also massive particles as members of SUSY multiplets. This should make possible also twistorialization in terms of octonionic gamma matrices reducing to quaternionic ones using representation of octonion units in terms of the structure constants of the octonionic algebra. The general structure of modified Dirac action suggests how to proceed.  $p^k \gamma_k$  should be replaced with a simplified version of its 8-D variant in  $M^4 \times CP_2$  and the  $CP_2$  part of this operator should describe the massivation.

1. Since light-like 3-surfaces contract to light-like curves at point like limit and since only  $CP_2$  gamma matrices contribute to Chern-Simons Dirac action, it is natural to assume that the  $CP_2$  projection of the light-like curve describing the particle characterizes the situation. The interpretation of the curve is in terms of center of mass motion of the topologically condensed space-time sheet describing the particle. For particles which are massless in  $M^4$ , the  $CP_2$  projection must contract to a point. For massive particles the projection is a curve in  $CP_2$ .
2. The generalization of the Dirac operator appearing in commutation relations reads as

$$p^k \gamma_k \rightarrow D = p^k \gamma_k + Q \gamma_k \frac{ds^k}{ds} ,$$

$$s_{kl} \frac{ds^k}{dt} \frac{ds^l}{dt} = 1 . \quad (11.6.1)$$

Mass shell condition fixes the value of  $Q$

$$Q = \pm m . \quad (11.6.2)$$

For geodesic circle the angle coordinate to be angle parameterizing the geodesic circle is the natural variable and the gamma matrices can be taken to be just single constant gamma matrix along the geodesic circle.

3. Imbedding space spinors have anomalous color charge equal to -1 unit for lepton and 1/3 units for quarks. Mass shell condition is satisfied if  $Q$  is proportional to anomalous hyper-charge and mass of the particle in turn determined by p-adic thermodynamics.
4. The geometric interpretation would be that in topological condensation the color rotational degrees of freedom of the particle are reduced. If the light-like 3-surfaces contains the geodesic the geodesic circle  $S^1$ , color rotational degrees of freedom are not lost completely and color hyper-charge remains a good quantum number in these degrees of freedom. It is however important to notice that anomalous color hypercharge has nothing to do with ordinary color quantum numbers.
5. Particle mass  $m$  should relate closely to the frequencies characterizing general extremals. Quite generally, one can write in cylindrical coordinates the general expressions of  $CP_2$  angle variables  $\Psi$  and  $\Phi$  as  $(\Psi, \Phi) = (\omega_1 t + k_1 z + n_1 \phi \dots, \omega_2 t + k_2 z + n_2 \phi \dots)$ . Here ... denotes Fourier expansion [?] , [?] : this corresponds to Cartan algebra of Poincare group with energy, one momentum component and angular momentum defining the quantum numbers. One can say that the frequencies define a warping of  $M^4$  for  $(\Psi, \Phi) = (\omega_1 t, \omega_2 t)$ . The frequencies characterizing the warping of the canonically imbedded  $M^4$  should closely relate to the mass of the particle. This raises the question whether the replacement of  $S^1$  with  $S^1 \times S^1$  is appropriate.
6. Twistor description is also required. Generalization of ordinary twistors to octotwistor with quaternionicity condition as constraint allows to describe massive particles using almost-twistors. For massive particle the unit octonion corresponding to momentum in rest frame, the octonion defined by the polarization vector  $\epsilon_k \gamma_k$ , and the tangent vector  $\gamma_k ds^k/ds$  (analog of polarization vector in  $CP_2$ ) generate quaternionic sub-algebra. For massless particle momentum and polarization generate quaternionic sub-algebra as  $M^4$  tangent space.

The SUSY algebra at QFT limit differs from the SUSY algebra defining the fundamental anti-commutators of the fermionic oscillator operators for the induced spinor fields since the modified gamma matrices defined by the Kähler action are replaced with ordinary gamma matrices. This is quite a dramatic difference and raises two questions. The first question "Why not replace the anti-commutation relations with those for the actual fermionic oscillator algebra?" has been already answered.



One can also wonder why not to replace Kähler action with the action defined by the 4-D volume in the induced metric? After all, apart from almost vacuum extremals 4-volume action has almost the same basic extremals ( $CP_2$  type extremals, restricted subset of massless extremals, string like objects). The modified gamma matrices for volume action are just induced gamma matrices reducing to  $M^4$  gamma matrices for canonically imbedded  $M^4$  so that the proposed form of the super-algebra in this framework can be seen as a well-motivated approximation. Also super-symmetry breaking induced by the mixing of  $M^4$  chiralities is expected to occur. There are however arguments in favor Kähler action.

1. Four-volume option has obvious shortcomings. Only very small space-time sheets are possible since vacuum functional decreases exponentially as a function of four-volume so that the Planck constant allowing space-time sheet with a given four-volume would scale like 1/four-volume. As a matter fact, also for Kähler action large value of Planck constant is required and this explains why string like objects correspond to a macroscopic quantum phase. Classical gauge fields would be completely absent from the space-time dynamics. The notion of effective 3-dimensionality would make no sense and the slicings by light-like 3-surfaces are not restricted to a finite volume surrounding the wormhole throat at QFT limit. Hence the value of  $\mathcal{N}$  is expected to be infinite and one can hope of obtaining the SUSY QFT limit with a finite value of  $\mathcal{N}$  only as an approximation.
2. For  $CP_2$  type extremals and string like objects the two actions are expected to give rise to a rather similar theory. Canonically imbedded  $M^4$  and its small deformations are an exception. The good news is that for the small deformations of  $M^4$  one can expect finite value of  $\mathcal{N}$  as an exact result rather than approximation.
3. The information about the zero modes - including vacuum degeneracy - is actually not lost as one replaces modified gamma matrices with the ordinary ones in anti-commutations since the Kähler potential defining the action principle (assuming bosonic emergence) carries information about zero modes. The Kähler potential carries also information about quantum fluctuating degrees of freedom coded by the super-potential at the maximum of Kähler function (with measurement interaction controllable by the experimenter included and affecting only the super-potential and thus the maximum of Kähler function but not WCW metric).
4. The quantum criticality of the Kähler action distinguishes Kähler action from four-volume. It predicts inclusion hierarchies of super-conformal algebras assignable to the zero modes. In each breaking of the super-conformal symmetry the rank of the WCW Kähler metric is reduced as quantum fluctuating degrees of freedom are transformed to zero modes. Some components of the inverse of the Kähler metric appearing in the Kähler potential diverge as a consequence and the corresponding complex coordinates of WCW transform to zero modes. This picture conforms with the view about SUSY breaking as a reduction of the rank of the Kähler metric defined by Kähler potential.

### 11.6.3 Explicit form of the SUSY algebra at QFT limit

The explicit form of the SUSY algebra follows from the proposed picture.

1. Spinor modes at  $X^2$  correspond to the generators of the algebra. Effective 2-D property implies that spinor modes at partonic 2-surface can be assumed to have well-defined weak isospin and spin and be proportional to constant spinors.
2. The anti-commutators of oscillator operators define SUSY algebra. In leptonic sector one has

$$\begin{aligned} \{a_{m\dot{\alpha}}^\dagger, a_\beta^n\} &= \delta_m^n D_{\dot{\alpha}\beta} \ , \\ D &= (p^k \sigma_k + Q^a \sigma_a) \ . \end{aligned} \tag{11.6.3}$$

$Q^a$  denote color charges. The notions are same as in the case of WCW Clifford algebra. In quark sector one has opposite chirality and  $\sigma$  is replaced with  $\hat{\sigma}$ . Both the ordinary and octonionic representations of sigma matrices are possible.

### 11.6.4 How the representations of SUSY in TGD differ from the standard representations?

The minimal super-sub-algebra generated by right-handed neutrino and antineutrino are the most interesting at low energies, and it is interesting to compare the naturally emerging representations of SUSY to the standard representations appearing in super-symmetric YM theories.

The basic new element is that it is possible to have short representations of SUSY algebra for massive states since particles are massless in 8-D sense. The mechanism causing the massivation remains open and p-adic thermodynamics can be responsible for it. Higgs mechanism could however induce small corrections to the masses.

The SUSY representations of SYM theories are constructed from  $J = 0$  ground state (chiral multiplet for  $\mathcal{N} = 1$  hyper-multiplet for  $\mathcal{N} = 2$ : more logical naming convention would be just scalar multiplet) and  $J = 1/2$  ground state for vector multiplet in both cases.  $\mathcal{N} = 2$  multiplet decomposes to vector and chiral multiplets of  $\mathcal{N} = 1$  SUSY. Hyper-multiplet decomposes into two chiral multiplets which are hermitian conjugates of each other. The group of R-symmetries is  $SU(2)_R \times U(1)_R$ . In TGD framework the situation is different for two reasons.

1. The counterparts of ordinary fermions are constructed from  $J = 1/2$  ground state with standard electro-weak quantum numbers associated with wormhole throat rather than  $J = 0$  ground state.
2. The counterparts of ordinary bosons are constructed from  $J = 0$  and  $J = 1$  ground states assigned to wormhole contacts with the electroweak quantum numbers of Higgs and electroweak gauge bosons. If one poses no restrictions on bound states, the value of  $\mathcal{N}$  is effectively doubled from that for representation associated with single wormhole throat.

These differences are allowed by general SUSY symmetry which allow the ground state to have arbitrary quantum numbers. Standard SYM theories however correspond to different representations so that the formalism used does not apply as such.

Consider first the states associated with single wormhole throat. The addition of righthanded neutrinos and their antineutrinos to a state with the constraint that  $p^k \gamma^k$  annihilates the state at partonic 2-surface  $X^2$  would mean that the helicities of the two super-symmetry generators are opposite. In this respect the situation is same as in the case of ordinary SUSY.

1. If one starts from  $J = 0$  ground state, which could correspond to a bosonic state generated by configuration space Hamiltonian and carrying  $SO(2) \times SU(3)_c$  quantum numbers one obtains the counterparts of chiral/hyper- multiplets. These states have however vanishing electro-weak quantum numbers and do not couple to ordinary quarks neither.
2. If one starts  $J = 1/2$  ground state one obtains the analog of the vector multiplet as in SYM but but belonging to a fundamental representation of rotation group and weak isospin group rather than to adjoint representation. For  $\mathcal{N} = 1$  one obtains the analog of vector chiral multiplet but containing spins  $J = 1/2$  and  $J = 1$ . For  $\mathcal{N} = 2$  one obtains two chiral multiplets with  $(J, F, R) = (1, 2, 1)$  and  $(J, F, R) = (1/2, 1, 0)$  and  $(J, F, R) = (0, 0, -1)$  and  $(-1/2, 1, 0) = (0, 0, 0)$ .
3. It is possible to have standard SUSY multiplet if one assumes that the added neutrino has always fermionic number opposite that the fermion in question. In this case one obtains  $\mathcal{N} = 1$  scalar multiplet. This option could be defended by stability arguments and by the fact that it does not put right-handed neutrino itself to a special role.

For the states associates with wormhole contact zero energy ontology allows to consider two non-equivalent options. The following argument supports the view that gauge bosons are obtained as wormhole throats only if the throats correspond to different signs of energy.

1. For the first option the both throats correspond to positive energies so that spin 1 bosons are obtained only if the fermion and antifermion associated with throats have opposite  $M^4$  chirality in the case that they are massless (this is important!). This looks somewhat strange but reflects the fact that  $J = 1$  states constructed from fermion and antifermion with same chirality and parallel 4-momenta have longitudinal polarization. If the ground state has longitudinal polarization the spin of the state is due to right-handed neutrinos alone: in this case however spin 1 states would have fermion number 2 and -2.

2. If the throats correspond to positive and negative energies the momenta are related by time reflection and physical polarizations for the negative energy antifermion correspond to non-physical polarizations of positive energy antifermion. In this case physical polarizations are obtained.

If one assumes that the signs of the energy are opposite for the wormhole throats, the following picture emerges.

1. If fermion and antifermion correspond to  $\mathcal{N} = 2$ -dimensional representation of super-symmetry, one expects  $2\mathcal{N} = 4$  gauge boson states obtained as a tensor product of two hyper-multiplets if bound states with all possible quantum number combinations are possible. Taking seriously the idea that only the bound states of fermion and antifermion are possible, one is led to consider the idea that the wormhole throats carry representations of  $\mathcal{N} = 1$  super-symmetry generated by  $M^4$  Weyl spinors with opposite chiralities at the two wormhole throats (right-handed neutrino and its antineutrino). This would give rise to a vector representation and eliminate a large number of exotic quantum number combinations such as the states with fermion number equal to two and also spin two states. This idea makes sense also for a general value of  $\mathcal{N}$ . Bosonic representation could be also seen as the analog of short representation for  $\mathcal{N} = 2N$  super-algebra reducing to a long representation  $\mathcal{N} = N$ . Short representations occur quite generally for the massive representations of SUSY and super-conformal algebras when  $2^r$  generators annihilate the states [?] .

Note that in TGD framework the fermionic states of vector and hyper multiplets related by  $U(2)_R$   $R$ -symmetry differ by a  $\nu_R \bar{\nu}_R$  pair whose members are located at the opposite throats of the wormhole contact.

2. If no restrictions on the quantum numbers of the boson like representation are posed, zero energy ontology allows to consider also an alternative interpretation.  $\mathcal{N} = 4$  (or more generally,  $\mathcal{N} = 2N$ -) super-algebra could be interpreted as a direct sum of positive and negative energy super-algebras assigned to the opposite wormhole throats. Boson like multiplets could be interpreted as a long representation of the full algebra and fermionic representations as short representations with states annihilated either by the positive or negative energy part of the super-algebra. The central charges  $Z_{ij}$  must vanish in order to have a trivial representations with  $p^k = 0$ . This is expected since the representations are massless in the generalized sense.
3. Standard  $\mathcal{N} = 2$  multiplets are obtained if one assume that right-handed neutrino has always opposite fermion number than the fermion at the throat. The arguments in favor of this option have been already given.

## 11.7 Super-symmetric QFT limit of TGD

The definition of the SUSY QFT limit of TGD involves several challenges. A generalization of the super-space concept is needed to cope with  $\mathcal{N} > 1$  symmetry and the notions of chiral and vector super-fields must be defined precisely. The previous findings about the super-multiplets assignable to fermions and bosons suggest that standard formalism does not generalize as such. Accordingly, two lines of approach are studied in this section. The first one relies on the generalization of the standard definitions chiral and vector super-fields applied in TGD framework, and works in practice only for  $\mathcal{N} = (1, 0)$  and  $\mathcal{N} = (0, 1)$  in fermionic sector and  $\mathcal{N} = (1, 1)$  in bosonic sector (notation is motivated by zero energy ontology). Second approach relies on a new view about super fields forced by the condition that the formalism makes sense for  $\mathcal{N} = \infty$ .

### 11.7.1 Basic concepts and ideas

A brief overview about basic concepts and ideas to be discussed in this section is in order before going to the details.

#### The notion of super-space

1. Majorana spinors do not make sense in TGD framework but the use of Weyl spinors as spinors with definite H-chirality is possible. It is possible to use spinor of fixed chirality only since

leptons and charge conjugates of quarks can be regarded as having same H-chirality. By hyper-quaternionicity the octonionic gamma matrices allow a matrix representation in terms of octonionic structure constants so that also octonionic formulation makes sense. The pair  $\{a_m^\dagger, a_m\}$  of oscillator operators corresponds to the pair  $(\bar{\theta}_{m\dot{\alpha}}, \theta_m^\alpha)$ .

2. A non-trivial question relates to the identification of the super-space. The first candidate is  $M^{1,\mathcal{N}}$ ,  $M = M^4 \times S^1$ ,  $S^1$  a geodesic circle of  $CP_2$ . Since the gamma matrices of  $S^1$  must be expressed in terms of  $H$  gamma matrices one can however argue that effectively super-space corresponds induced from  $M^{1,\mathcal{N}}$ ,  $M = H$ . This and the condition of hyper-quaternionicity suggest the notion of induced super-symmetry suggests itself meaning that  $D = 4$  holds true effectively. The value of  $\mathcal{N}$  would be naturally  $\mathcal{N} = 2$  for fermions and  $\mathcal{N} = 4$  for bosons if one restricts the consideration to right-handed neutrino and antineutrino modes since  $CP_2$  spinor indices are effectively frozen in this case. If the numbers of quark and lepton like modes are different, one has  $\mathcal{N} = (\mathcal{N}_1, \mathcal{N}_2)$  super-symmetry, and the axial anomaly with respect to  $H$ -chirality is possible. The different couplings of lepton and quark fields to Kähler gauge potential should take care of the anomaly.

### Super-covariant derivatives

Consider next the definition of super-covariant derivatives.

1. The dotted and un-dotted indices  $D_{m,\alpha}$  *resp.*  $D_{m,\dot{\alpha}}$  label the spin and weak isospin indices of quark *resp.* lepton like spinors. The indices  $m$  label the spinor modes associated with quarks and leptons for the space-time sheet whose zero modes are coded by the induced  $CP_2$  Kähler form  $J_{\alpha\beta}$ . Also now leptons and antiquarks can be regarded as two induces spinor field with same chirality so that one has  $\mathcal{N} = 2N$  super-symmetry.
2. Super-covariant derivatives can be defined by modifying the usual definitions in rather obvious manner.

$$D_{m,\alpha} = \frac{\partial}{\partial \theta_{m,\alpha}} - iQ_{\alpha\dot{\alpha}} \bar{\theta}_m^{\dot{\alpha}}, \quad \bar{D}_{m\dot{\alpha}} = -\frac{\partial}{\partial \bar{\theta}_{m,\dot{\alpha}}} + i\theta_m^\alpha Q_{\alpha\dot{\alpha}}, \quad Q = \sigma^A(p_A + Q_A). \quad (11.7.1)$$

3. The anti-commutations for given a H-chirality can be written as

$$\begin{aligned} \{D_{m\alpha}, D_{n\beta}\} &= 0, & \{\bar{D}_{m\dot{\alpha}}, \bar{D}_{n\dot{\beta}}\} &= 0, \\ \{D_{m\alpha}, \bar{D}_{n\dot{\beta}}\} &= \delta_m^n D_{\alpha\dot{\beta}}. \end{aligned} \quad (11.7.2)$$

### Identification of the super-fields: conventional approach

Also now super-field can be defined in terms of the Taylor expansion with respect to theta parameters. Chiral super-fields satisfy the usual conditions given by

$$D_{m\alpha} \Phi = 0, \quad \bar{D}_{m\dot{\alpha}} \Phi = 0. \quad (11.7.3)$$

The differences from standard SUSY are due to the fact that fermions have ground state which is not scalar but  $J = 1/2$  particle whereas bosons correspond to  $J = 1$  ground states and wormhole throats so that  $\mathcal{N}_B = 2\mathcal{N}_F$  holds true. This means that  $J = 0$  chiral field must be replaced with spin  $J = 1/2$  and  $\mathcal{N} = 2$  chiral superfield in the case of fermions and spin  $1/2$  vector field must be replaced with spin  $J = 1$   $\mathcal{N}_B = 4$  analog of vector super-field unless one poses additional conditions of the allowed bound states to reduce  $\mathcal{N}_B$  to  $\mathcal{N}_B = 2$ .

As found, the assumption that right handed neutrino has fermion number opposite to the fermion state assigned to the throat reduces the fermionic super-symmetry to  $\mathcal{N} = 1$  and bosonic super-symmetry to  $\mathcal{N} = 2$  and fermionic states can be regarded as short representations of  $\mathcal{N} = 2$  super-symmetry natural in zero energy ontology. With these assumptions standard formalism works as such.

1. The chiral super-field can be written as

$$\Phi = \Phi(\theta_m, H^k) , \quad H^k = h^k + i\bar{\theta}_m \bar{Q} \theta^m , \quad h^k \equiv (m^k, \phi) . \quad (11.7.4)$$

Here the sum is over both lepton and antiquark plus modes mode the induced spinor field.

2. Vector super-fields describe gauge bosons and their super-counterparts.  $V = V^\dagger$  is satisfied. The definition of vector super field is as usual. One starts from super field  $V$  and defines super gauge transformations as transformations  $V \rightarrow V + \Lambda + \Lambda^\dagger$ , where  $\Lambda$  is chiral spinor super-field.

$$W_{m\alpha} = XD_{m,\alpha}V , \quad \bar{W}_{m\alpha} = \bar{X}\bar{D}_{m,\alpha}V , \quad X = -\frac{1}{2^{\mathcal{N}}} \prod_{m,\alpha} \bar{D}_{m\alpha} . \quad (11.7.5)$$

defines a gauge invariant quantity analogous to gauge field. Chiral super-fields transform as  $\Phi \rightarrow \exp(\Lambda)\Phi$ ,  $\Phi^\dagger \rightarrow \Phi^\dagger \exp(\Lambda^\dagger)$ .

The quantity

$$L = \Phi^\dagger \exp(-V)\Phi . \quad (11.7.6)$$

is gauge invariant and defines a generalization of Dirac Lagrangian. This action can be regarded as a particular Kähler potential.

3. For ordinary SUSYs Kähler potential can be very general real function of super-fields and the space of super-fields defines Kähler manifold. Also super-potential which is sum of holomorphic function of chiral super-fields and its conjugate is possible and corresponds to the addition of real part of complex function to Kähler potential is possible. These terms are make possible breaking of super-symmetry by a generation of vacuum expectation values of some scalar fields.

**Identification of the super-fields: the approach inspired by  $\mathcal{N} = \infty$  case**

The standard approach does not work at all for  $\mathcal{N} = \infty$  and becomes highly questionable also for the values of  $\mathcal{N}$ , which are large. Zero energy ontology and the identification of fermions as wormhole throats and bosons as wormhole contacts inspires a new manner to see super fields. Positive energy chiral fields correspond to analytic functions of  $\theta$  alone with no dependence on  $\bar{\theta}$ . Negative energy chiral field is obtained as hermitian conjugate of this field. Hermitian conjugation maps  $\theta$  to  $\partial_\theta D$  in positive energy chiral super field and the resulting operator acts on the product  $X$  of all theta parameters. Note that the presence of  $D$  is essential for obtaining the generalization of Dirac action. Note that in this approach there is no need to introduce super-derivatives and  $\theta$ s and  $\partial_\theta D$ s define the representation of the space-time super-symmetry algebra. Super vector fields are defined as hermitian operators of form  $V_k = V_k(\theta, \partial_\theta)$  acting on chiral super-fields, and the generalization of chiral action with coupling to super vector fields is obtained by the minimal substitution  $D \rightarrow D + V$ .

**SUSY breaking**

The general vision about breaking of super-symmetry would be following.

1. The effective dimension of space-time as it appears in the anticommutators of super-generators in  $D = 5$ . Since the number of components of 5-D Weyl spinors is 4, the number  $\kappa$  of supergenerators is given by  $\kappa = 4\mathcal{N}$ .

2. One obtains a hierarchy of SUSY breakings. It is possible to decompose the full SUSY action to a sum of actions with a smaller value of  $\mathcal{N}$  by integrating over theta parameters associated with the higher modes of the induced spinor field. It is also possible to take into account only finite number of spinor modes. The presence of higher modes poses strong constraints on the coupling parameters of the SUSY action.
3. Taking into account only right-handed neutrino and its antineutrino, the number of real supercharges is  $\kappa = 8$  so that if  $D = 5$  is the effective space-time dimension  $\mathcal{N} = (1, 1)$  SUSY is obtained at the lowest level in good approximation due to the electro-weak inertness of right-handed neutrinos.

### 11.7.2 About super-field formalism in $\mathcal{N} = 2$ case

For SUSY limit of quantum TGD assuming that only right-handed neutrinos and antineutrinos appear as generators of super-symmetries and that the added righthanded neutrino has fermion number opposite that that of the fermion of the throat corresponds to  $\mathcal{N} = 2$  for gauge bosons and Higgs and to  $\mathcal{N} = 1$  equivalently  $\mathcal{N} = 2$  short representation for fermions. For this option super-field formalism guarantees also the conservation of fermion numbers automatically. With these assumptions it is of considerable interest to summarize the basic facts of  $\mathcal{N} = 2$  super-fields.

1.  $\mathcal{N} = 2$  super-multiplets are known as vector multiplet assigned to gauge bosons and their partners and hyper multiplet assigned with matter. Vector multiplet contains two Weyl fermions and vector boson and scalar in adjoint representations. The two fermionic states transform non-trivially under the R-symmetry group  $SU(2)_R \times U(1)_R$ . Vector multiplet decomposes under  $\mathcal{N} = 1$  supersymmetry to vector multiplet and chiral multiplet. Hyper-multiplet consists of two Weyl fermion and complex bosons and  $SU_R$  mixes the two fermions. Two  $\mathcal{N} = 1$  multiplets are in question.
2. A pedagogical representation for the generalization of  $\mathcal{N} = 1$  SYM action to  $\mathcal{N} = 2$  case can be found in the article of Adel Bilal [?] . This action includes only  $\mathcal{N} = 2$  super partners of gauge boson which are all in the adjoint representation of the gauge group.  $\mathcal{N} = 2$  vector multiplet decomposes to  $\mathcal{N} = 1$  vector multiplet and chiral multiplet and the  $\mathcal{N} = 1$  reduction of the action gives sum of  $\mathcal{N} = 1$  YM action and Kähler potential.  $\mathcal{N} = 2$  symmetry allows no superpotential for vector multiplet. The super YM action is determined by a holomorphic function known as pre-potential fixed completely by renormalizability to be quadratic function of  $\mathcal{N} = 2$  vector super-field  $\Psi$ .
3. The Lagrangian of  $\mathcal{N} = 2$  SUSY YM theory reduced to  $\mathcal{N} = 1$  notation reads as

$$L = \frac{1}{4\pi} \text{Im} \left[ \int d^4\theta \frac{\partial \mathcal{F}(A)}{\partial A} + \int d^2\theta \frac{1}{2} \frac{\partial^2 \mathcal{F}(A)}{\partial A^2} W_\alpha W^\alpha \right] . \quad (11.7.7)$$

$A$  denotes  $\mathcal{N} = 1$  chiral multiplet in  $\mathcal{N} = 2$  vector multiplet whose scalar component is denoted by  $a$ .

4.  $\mathcal{N} = 2$  supersymmetry implies that the Kähler potential and Kähler metric associated with the vector multiplet can be written in terms of single holomorphic function  $\mathcal{F}(A)$  known as prepotential as

$$\begin{aligned} K &= \text{Im} \left( \frac{\partial \mathcal{F}(A)}{\partial A} \bar{A} \right) , \\ ds^2 &= \text{Im} \left( \frac{\partial^2 \mathcal{F}(A)}{\partial^2 a^2} \right) da d\bar{a} . \end{aligned} \quad (11.7.8)$$

5. In the classical theory tree level Lagrangian allows to deduce  $\mathcal{F}(A)$  as

$$\mathcal{F}(A) = \frac{1}{2} \times \tau_{cl} A^2, \quad \tau_{cl} = \frac{\theta}{2\pi\hbar} + i \frac{4\pi}{g^2}. \quad (11.7.9)$$

Here  $\tau$  unifies gauge coupling strength and  $\theta$  parameter associated with the instanton term to single complex parameter and the holomorphy of  $\mathcal{F}(a)$  poses very powerful constraints on the theory.

The expression of the scalar potential associated with vector multiplet reads as

$$V(\phi) = \frac{1}{g^2} \text{Tr}(\phi, \phi^\dagger)^2. \quad (11.7.10)$$

Scalar potential vanishes in the sub-space defined by the Cartan algebra of gauge group so that scalar potential has  $r$ -dimensional sub-manifold of vanishing extrema, where  $r$  is the rank of the Cartan sub-algebra. Radiative corrections affect  $V$  so that the vacuum degeneracy disappears. Note that vacuum degeneracy is analogous to the vacuum degeneracy of Kähler action in TGD.

There are very strong constraints on the moduli space defined by scalars [?].

1. For  $D = 4$  and  $\mathcal{N} = 2$  the moduli space associated with the vector multiplet (so called Coulomb branch) contains one complex scalar defining so calling special Kähler manifold [?]. The moduli space associated with hyper-multiplet (so called Higgs branch) contains two scalars and is Hyper-Kähler manifold [?]. For  $\mathcal{N} > 2$  the moduli spaces are symmetric spaces. The article of Antoine van Proyen discusses vector multiplets in  $\mathcal{N} = 2$  supersymmetry and associated moduli spaces for the scalar fields appearing in the theory and fixed to a high degree by super-symmetry.
2. This picture conforms with the view that WCW is infinite-dimensional symmetric space with Hyper-Kähler structure and corresponds to the moduli space of hypermultiplet.

In TGD framework vector multiplets are associated with wormhole contacts. They do not represent fundamental degrees of freedom and describe at QFT limit phenomenologically bound states since it is the total momentum and color charge which appear in the modified Dirac equation in regions surrounding both wormhole throats. With above described assumptions about super-symmetry the bosonic multiplets are  $\mathcal{N} = 2$  multiplets whereas fermionic ones are short variants of them. Zero energy ontology plays an essential role.

### 11.7.3 Electric magnetic duality, monopole condensation and confinement from TGD point view

$\mathcal{N} = 2$  SYM theory was studied by Seiberg and Witten in their seminal paper *Electric-magnetic duality, monopole condensation, and confinement in  $\mathcal{N} = 2$  super-symmetric Yang-Mills theory* [?] and it is interesting to try to see the results of Seiberg and Witten from TGD point of view. Electric magnetic duality conjecture of Olive and Montonen was inspired by the observation about the upper bound from the masses of dyons deduced by Prasad and Somerfield and Bogomol'nyi (BPS) and reading as

$$M \geq \sqrt{|Z|}, \quad Z = v(n_e + i \frac{n_m}{\alpha}). \quad (11.7.11)$$

Here  $v$  denotes Higgs expectation value,  $\alpha = g^2/4\pi\hbar$  is gauge coupling strength, and  $n_e$  and  $n_m$  characterize the electric and magnetic charges of the dyon. States for which equality holds true in above formula are called BPS saturated and they correspond to massive representation of SUSY with the same number of states as appearing in massless representations. The observation inspiring the

duality conjecture was that the formula is symmetric under  $n_e \leftrightarrow n_m$ ,  $v \leftrightarrow v/\alpha$ , and  $\alpha \leftrightarrow 1/\alpha$ . Electric magnetic duality implies that the strong coupling phase for ordinary particles can be understood as a weak coupling phase for monopoles.

Witten demonstrated that in the original sense this duality can hold true for  $\mathcal{N} = 4$  theories since only in this case the electrons and monopoles have same quantum number spectrum but in the case of  $\mathcal{N} = 2$  theories it can hold true at the low energy Abelian limit of the theory and between particle and special class of dyons with vanishing electric charges (neutral magnetic monopoles). The duality of Montonen and Olive actually generalizes in the sense that all transformation of the group  $SL(2, Z)$  acting on the complex coupling strength

$$\tau = i \frac{4\pi\hbar}{g^2} + \frac{\theta}{2\pi}$$

transform different phases of the theory to each other. These transformations also transform dyons with charges  $(n_m, n_e)$  to each other.

An interesting question is whether electric magnetic duality and color confinement based on the condensate of magnetic monopoles could have counterparts in TGD framework.

1. The counterpart for the electric phase corresponds to wormhole throats surrounded by a slicing by light-like 3-surfaces with boundary so that momentum and color charges can be assigned to single wormhole throat and  $\mathcal{N}$  for the entire super-algebra is finite.
2. Also the counterpart of the magnetic phase exists. Topological magnetic monopoles make sense in TGD framework since the topology of  $CP_2$  allows wormhole throats carrying homological magnetic charges. Monopole phase could exist in the sense that the outer boundary of the space-time sheet carries the neutralizing magnetic charge or that the wormhole throats feed the magnetic fluxes to large space-time sheets. Also the deformations of string like objects  $X^2 \times Y^2 \subset M^4 \times CP_2$  carry naturally magnetic fluxes along them and could feed them to larger space-time sheets through magnetically charged wormhole throats defining bosonic super-multiplet. Also fermions with opposite magnetic charges can topologically condense at string like object and effectively serve as its ends. The same momentum and color charge would be associated with all wormhole throats associated with a given string like object having an interpretation as hadron-like object so that a color confined perturbative phase would be in question. The value of  $\mathcal{N}$  for the entire super-algebra is infinite for string like objects and the description in terms of super-conformal algebra seems to be more appropriate than QFT description. In this sense one would have genuinely non-perturbative phase.
3. As Witten shows, in  $\mathcal{N} = 2$  theory electric magnetic duality of Montonen and Olive fails in  $\mathcal{N} = 2$  SUSY because the number of states for electron multiplet is 4 and contains spin 1 state whereas monopole states have  $J \leq 1/2$ . In TGD framework the reduction of  $\mathcal{N} = 2$  symmetry to  $\mathcal{N} = 1$  symmetry for massless fermions changes the situation so that a natural conjecture is that electric magnetic duality actually holds true in TGD framework. If the conjecture is really true, it could be seen as a support for zero energy ontology as also for the identification of fermions as wormhole throats and bosons as wormhole contacts.
4. The mapping of the coupling constant to its inverse cannot apply to the Kähler coupling strength fixed by the quantum criticality but makes sense for the color coupling strength. If one accepts holography, then light-like 3-surfaces are fundamental objects and whether one can regard them as magnetic monopoles or not, depends on the space-time sheets assigned to them. This assignment could change in a phase transition transforming the space-time sheets surrounding the wormhole throats so that particles would transform to monopole like entities. More generally, the basic objects would be dyons and the phase transitions would be characterized by  $SI(2, Z)$ .
5. One can of course, ask whether the inverse of Kähler coupling strength, which is analogous to the inverse of critical temperature and with CP breaking theta angle added to it as an imaginary part, could have a discrete spectrum of values identifiable as the orbit of  $SI(2, Z)$ .



### 11.7.4 Interpretation of Kähler potential and super-potential terms in TGD framework

TGD suggests the interpretation of Kähler potential and superpotential in terms of WCW geometry.

1. The Kähler potential could be interpreted in terms of WCW Kähler function. If  $K$  is quadratic in chiral super-field only the dependence on zero modes is possible. This is what is required since integration over quantum fluctuating degrees of freedom is carried out at QFT limit. Maximum of configuration space Kähler function defines Kähler potential. Spinor modes more or less in 1-1 correspondence with coordinates of WCW. Could Kähler potential define the Kähler potential of WCW which would thus make itself directly visible at space-time level.
2. Super-potential term could be interpreted as counterpart for the addition of a real part of holomorphic function to Kähler function. This part would not affect WCW metric but would characterize different measurement interactions. Separate conservation of lepton and quark numbers require that super-potential is sum over lepton and quark contributions. R-parity conservation allows only quadratic super-potential. By quantum criticality the moduli space for the super-potential could correspond to the modifications of Kähler function not affecting Kähler metric but affecting the maximum of Kähler function and thus space-time sheet. This would be counterpart for the non-renormalization theorems of super-potential in SUSYs.

### 11.7.5 Generalization of bosonic emergence

Generalization of the bosonic emergence. The propagators for wormhole contacts carrying manyfermion states at wormhole throats are induced by propagators assignable to single throats as radiative corrections. Dirac action is replaced with  $K = \Phi^\dagger \exp(V) \Phi$ , where  $\Phi$  is chiral super field.

Different measurement interactions correspond to different super-potentials.

By previous arguments bosonic emergence would mean that the super-variant of the configuration space Kähler function defines the super-symmetric action principle at QFT limit so that one can say that the geometrization of quantum physics takes place in a very concrete sense also at QFT limit. This would be quite an elegant physical manifestation of the underlying infinite-dimensional geometry.

### 11.7.6 Is $\mathcal{N} > 8$ super-symmetry internally consistent?

The standard wisdom says that  $\mathcal{N} = 8$  is absolute upper bound for the super-symmetry (spins larger than 2 are not regarded as physical). In TGD  $\mathcal{N} = 8$  emerges naturally for space-time surfaces due to the dimension  $D = 8$  of imbedding space and the fact that imbedding space spinors with a given H-chirality (quarks and leptons which color appearing as partial waves in  $CP_2$  have 8 complex components. One obtains  $\mathcal{N} = 8$  without restrictions if one considers only the super-algebra defined by the oscillator operators associated with the lowest modes of these spinor fields at light-like 3-surfaces obtained as a solutions of the modified Dirac equation with measurement interaction term.

It is also possible to consider the super-symmetry generated by all modes of the induced spinor fields and thus with a quite large (even infinite for string like objects) number  $\mathcal{N}$  of super generators. This super-symmetry is broken as all super-symmetries in TGD framework. This means that rather high spins are present in the analogs of scalar and vector multiplets and the Kähler potential (expected to be closely related to the Kähler function of the world of the classical worlds (WCW)) describing interaction of chiral multiplet with a vector multiplet can be constructed also for any value of  $\mathcal{N}$  - at least formally. If one believes on the generalization of the bosonic emergence, one expects that bosonic part of the action is generated radiatively as one functionally integrates over the fields appearing in the chiral multiplet.

The standard wisdom says that it is not possible to construct interactions for higher spin fields. Is this really true? Why wouldn't the analogs of scalar (chiral/hyper) and vector multiplets make sense for higher values of  $\mathcal{N}$ ? Why would it be impossible to define a spin 1/2 chiral super-field associated with the vector multiplet and therefore the super-symmetric analog of YM action using standard formulas? Why the standard coupling to chiral multiplet would not make sense?

One objection against higher spins is of course the lack of the geometric interpretation. Spin 1 and Spin 2 fields allow it. Can one then imagine any geometric interpretation for higher spin components of super-fields? John Baez and others [?] are busily developing non-Abelian generalizations of group

theory, categories and geometry and speak about things that they call n-groups, n-categories, and n-geometries. Could the generalization of ordinary geometry to n-geometry in which parallel translations are performed for higher dimensional objects rather than points provide a natural interpretation for gauge fields assigned to higher spins? One would have natural hierarchy. Parallel translations of points would give rise curves, parallel translations of curves would give rise to surfaces, and so on. As a special case the entire hierarchy of these parallel translations would be induced by ordinary parallel translation.

### 11.7.7 Super-fields in TGD framework

In the case of infinite-dimensional super-space the definition of the super-fields is not quite straightforward since the super-space integrals of finite polynomials of theta parameters always vanish so that the construction of super-symmetric action as an integral over super-space would give a trivial result. For chiral fields the integrals are formally non-vanishing but in the case that the super-field reduces to a finite polynomial of theta at  $y^\mu = 0$  the non-vanishing terms in real Lagrangian involve the action of an infinite number of operators  $\bar{D}_\alpha$  implying the proportionality to an infinite power of momentum which vanishes for massless states. It seems that one should be able to add in a natural manner terms which are obtained as theta derivatives of the product of all theta parameters and that the action should consist of the products of the terms associated with monomials of theta and monomials of derivatives with respect to theta parameters acting on the infinite product of theta parameters, call it  $X$ .

The fact that positive *resp.* negative energy vacuum is analogous to Dirac sea with negative *resp.* positive energy states filled suggests a remedy to the situation. This would mean that positive energy chiral field is just like its ordinary counterpart whereas negative energy chiral fields would be obtained by applying a polynomial of derivatives of theta to the product  $X = \prod \theta_{i\alpha}$  of all theta parameters. The theta integral of  $X$  is by definition equal to 1. In integral over theta parameters the monomials of theta associated with positive energy chiral field and negative energy chiral field would combine together and one would obtain desired action. In the following this approach is sketched. Devil lies in the details and detailed checks that everything works are not yet done.

#### TGD variants of chiral super fields

Consider first the construction of chiral super-fields and of the super-counterpart of Dirac action.

1. Wormhole throats carry a collection of *collinearly* moving fermions with momentum appearing in the measurement interaction term identified as the total momentum. This suggests that kinetic terms behave positive powers of Dirac operator with one power for each theta parameter.
2. One must be careful with dimensions. The counterpart of Dirac operator is  $D = \sigma^k(p_k + Q_k)/M$ . The mass parameter  $M$  must be included for dimensional reasons and changes only the normalization of the theta parameters from that used earlier and changes the anti-commutation relations of the super-algebra in an obvious manner. The value of  $M$  is determined by quantum criticality since it appears also in the measurement interaction term. The first guess for the value of  $M$  is of order  $CP_2$  mass defined as  $m(CP_2) = n\hbar_0/R$ , where  $R$  is the length of  $CP_2$  geodesic and  $n$  is a numerical constant. The proposal for a bi-local QFT limit describing gravitational interaction leads to the conclusion that gravitational constant is proportional to  $1/M^2$ .
3. In the case of single wormhole throat one can speak about positive and negative energy chiral fields. Positive energy chiral fields are constructed as polynomials, and more generally, as Taylor series whereas negative energy chiral fields are obtained by mapping positive energy chiral fields to an operator in which each theta parameter  $\theta$  is replaced with

$$\partial_\theta D = \partial_\theta \sigma^k \frac{(p_k + Q_k)}{M} . \quad (11.7.12)$$

This operator acts in the product  $X$  of all theta parameters to give the negative energy counterpart of chiral field. The inclusion of sigma-matrices is necessary in order to obtain chiral

symmetry at the level of  $H$ , in particular the counterpart of Dirac action. In the integral over all theta parameters defining the Lagrangian density the terms corresponding to monomials  $M(\theta, x)$  and their conjugates  $M(\partial_{\bar{\theta}} D^\dagger, x)$  are paired and theta integrals can be carried out easily. Here  $\rightarrow$  tells that the spatial derivatives appearing in  $D$  are applied to  $M$ .

4. There is an asymmetry between positive and negative energy states and the experience with the ordinary Dirac action  $\bar{\Psi} D^\dagger \Psi - \bar{\Psi} D^\dagger \Psi$  suggests that one should add a term in which  $\theta$  parameters are replaced with  $-D\theta$  so that space-time derivatives act on the positive energy chiral field and partial derivative  $\partial_{\bar{\theta}}$  appear as such. The most plausible interpretation is that the negative energy chiral field is obtained by replacing  $\theta$ s in the positive energy chiral field with  $\partial_{\theta} X$  and allowing to act on  $X$ . The addition of  $D$  would thus give rise to the generalization of the kinetic term.
5. Chiral condition can be posed and one can express positive energy chiral field in as an infinite powers series containing all finite powers of theta parameters whereas negative energy chiral field contains only infinite powers of  $\theta$ . The interpretation is in terms of different Dirac vacuum. What one means which super-covariant derivatives is not quite clear.

(a) The usual definition of super covariant derivatives would be as

$$D_{i\alpha} = \partial_{i\alpha} + i(\bar{\theta}D)_{i\alpha} \quad , \quad \bar{D}_{i\dot{\alpha}} = \partial_{\theta i\dot{\alpha}} + i(D\theta)_{i\dot{\alpha}} \quad . \quad (11.7.13)$$

(b) A definition giving rise to the same anti-commutators would be as

$$D_{i\alpha} = \partial_{i\alpha} \quad , \quad \bar{D}_{i\dot{\alpha}} = \partial_{i\dot{\alpha}} + 2i(D\theta)_{i\dot{\alpha}} \quad (11.7.14)$$

In the recent case  $\bar{D}$  does not appear at all in the chiral action since for negative energy chiral field conjugation does not correspond to  $\theta \rightarrow \bar{\theta}$  but to  $\theta \rightarrow \partial_{\theta}$  and  $1 \rightarrow X$ . Hence the simplest theory would result using  $D_\alpha = \partial_{i\alpha}$ .

- (c) If one includes into the product of  $X$  of theta parameters only  $\theta$ s but not their conjugates, the two definitions are equivalent since the powers of  $\bar{\theta}D\theta$  give nothing in theta integration. This definition of  $X$  is possible using the definition of hermitian conjugation appropriate also for  $\mathcal{N} = \infty$ . This formalism of course works also for a finite value of  $\mathcal{N}$ .

Consider now the resulting action obtained by performing the theta integrations. The interesting question is what form of the super-covariant derivatives one should use. The following considerations suggests that the two alternatives give almost identical -if not identical- results but that the simpler definition  $D_\alpha = \partial_{i\alpha}$  is much more elegant.

1. For  $D_\alpha = \partial_{i\alpha}$  the propagators are just inverses of  $D^d$  where  $d$  is the number of theta parameters in the monomial defining the super-field component in question so that the Feynman rules for calculating bosonic propagators and vertices are very simple. Only the spinor and vector terms corresponding to degree  $d = 1$  and  $d = 2$  in theta parameters behave in the expected manner. This conforms with the collinearity. In particular, for spin 2 states the propagator would behave like  $p^{-4}$  for large momenta. This conforms with the prediction that graviton cannot correspond to singlet wormhole throat but to a string like object consisting of a superposition of pairs of wormhole contacts and of wormhole throats. If this expansion makes sense, higher spin propagators would behave as increasingly higher inverse powers of momentum and would not contribute much to the high energy physics. At energies much smaller than mass scale they would give rise to contact terms proportional to a negative power of mass dictated by the number of thetas.
2. For  $D_\alpha = \partial_{i\alpha} + i(\bar{\theta}D)_\alpha$  the situation is considerably more complex although the basic contribution to the propagators is same. The chiral field property using the standard definition means that propagator is multiplied by an infinite geometric series in  $D^2$  coming from the contractions of  $\bar{\theta}D\theta$  in positive energy chiral super-field as they are contracted with corresponding terms  $\partial_{\bar{\theta}} D \partial \theta$  appearing in negative energy chiral super-field acting on  $X$ . The summation can be done

by Feynman rules for a "free field theory" in which incoming particles correspond to  $\theta$  parameters and outgoing particles to partial derivatives with respect to theta parameters. The rule is that any theta parameter can be connected to any derivative with respect to theta parameter and any pair of theta parameters and its conjugate connected in this manner gives  $D^2/M^2$  as a result. For the  $N$ :th power of  $\bar{\theta}D\theta$  a given theta can be connected to  $\partial\theta$  in  $N!$  manner and same applies to its conjugate. Hence the  $1/N!$  factors coming from the expansion of plane wave  $\exp(ip \cdot m + i\bar{\theta}D\theta)$  cancel each other and one obtains geometric series.

- (a) These rules assign to the power series  $\exp(i\bar{\theta}D\theta)$  an over-all factor

$$Y = \mathcal{K}Y_1, \quad Y_1 = \frac{1 - \left(\frac{p^2 - m^2}{M^2}\right)^{K+1}}{1 - \frac{p^2 - m^2}{M^2}}. \quad (11.7.15)$$

The integer  $K$  results when one truncates the SUSY to a SUSY with finite value of  $\mathcal{N}$ . The value of  $K$  depends somewhat on the number of theta parameters associated with the field component but approaches infinite value for  $\mathcal{N} = \infty$ .

- (b) Propagator is inversely proportional to  $Y$ . This factor appears also in vertices and since the propagators and vertices defining the bosonic action involve always chiral loops with the same number of chiral field propagators and incoming vector super-fields the factors  $\mathcal{N}$  cancel out neatly.
- (c) For  $p^2 \ll M^2$  the factor  $Y_1$  equals to unity in good approximation. For  $|p^2 - m^2| \gg M^2$   $Y_1$  diverges at the limit  $\mathcal{K} \rightarrow \infty$  and propagator vanishes for  $|p^2 - m^2| \gg M^2$ , which raises the hope about dynamical cutoff guaranteeing UV finiteness. Vertices however contain a similar factor. Again the fact that the loops defining the bosonic vertices and propagators contain same number of vertices and propagators implies that these factors cancel each other.
- (d) The overall result seems to be a presence of infinite factors which however cancel completely in the expressions for bosonic vertices and propagators and introduce only a small effect at low energies. For  $D_\alpha = \partial_{i\alpha}$  all these complications are avoided. It should not be difficult to decide between these options.

### TGD variant of vector super field

Chiral super-fields are certainly not all that is needed. Also interactions must be included, and this raises the question about the TGD counterpart of the vector super-field.

1. The counterpart of the chiral action would be a generalization of the Dirac action coupled to a gauge potential obtained by adding the super counterpart of the vector potential to the proposed super counterpart of Dirac action. The generalization of the vector potential would be the TGD counterpart of the vector super field. Vector particle include  $M^4$  scalars since Higgs behaves as  $CP_2$  vector and  $H$ -scalars are excluded by chiral invariance.
2. Since bosons are bound states of positive and negative energy fermions at opposite wormhole throats it seems that vector super field must correspond to an operator slashed between positive and negative energy super-fields rather than ordinary vector super-field. The first guess is that vector super-field is an operator expressible as a Taylor series in which positive energy fermions correspond to the powers of  $\theta_\alpha$  and negative energy fermions correspond to the powers of derivatives  $\partial_{\theta_\alpha}$ . Naively,  $D$  in  $\partial_\theta D$  is replaced by  $D+V$ . Vector super-field must be hermitian ( $V = V^\dagger$ ) with hermitian conjugation defined so that it maps theta parameters to the partial derivatives  $\partial_\theta$  and performs complex conjugation. A better guess is that  $D$  appearing in the definition of the kinetic term is replaced with  $D + V$  where  $V$  is a hermitian super-field. This definition would be direct generalization of the minimal substitution rule.
3. It is important to notice that the gauge bosons appearing in the covariant derivatives have *same momentum* so that the interaction terms are local in momentum space rather than x-space. This conforms with the view that the  $N$  virtual bosons emitted in the  $N + 2$  vertex propagate along single wormhole throat. For bosonic emergence these couplings give rise to exchanges of

$N$  collinear vector particles between two fermion lines behaving like  $(k^2 - m^2)^{-2N}$  and thus approaching rapidly to zero in UV and contact interaction in IR. For  $m = 0$  one obtains series of interactions corresponding to potentials of form  $V \propto r^{2n+1}$ . For massive case these interactions are screened by the Yukawa factor  $\exp(-mr/\hbar)$ . Confining linear interaction potential in QCD could result in this manner for  $m = 0$  and  $N = 2$ . If the coupling were local in x-space the exchange would involve  $N - 1$  free loop momenta giving loop integral diverging like  $\lambda^{2N-4}$  as a function of momentum cutoff. Already for  $d = 2$  one would obtain logarithmic divergence.

4. It is difficult to imagine how a kinetic term for the vector super-field could be defined. This supports the idea that bosonic propagators and vertices emerge as one performs functional integral over components of the chiral fields.
5. There is also the question about gauge invariance. The super-field generalization of the non-Abelian gauge transformation formula looks more like the generalization of Dirac action to its super-counterpart:  $D \rightarrow D + V$  everywhere. Here  $V$  is the contraction of sigma matrices with super-field  $V_k$ , which is vector field in  $M^4$  having also  $S^1$  component which does not depend on  $S^1$  coordinate. Positive energy chiral field would transform as  $\Phi_+ \rightarrow \exp(\Lambda)\Phi$ , where  $\lambda$  is a chiral field. The negative energy chiral field would transform as  $\Phi_- \rightarrow \Phi_- \exp(\Lambda^\dagger)$  with hermitian conjugation involving also the map of thetas to their derivatives. Each theta parameter would represent a fermion transforming under gauge symmetries in a manner dictated by its electro-weak quantum numbers (the inclusion of color quantum numbers is not quite trivial: probably they must be included as a label for quark modes). As in the case of Dirac action, the transformation formula for vector super-field would be dictated by the requirement that the derivatives of  $\Lambda$  coming from  $\exp(\Lambda)$  are canceled by the derivative terms in the transformation formula for the vector super field. The resulting transformation formulas are identical with standard ones formally since the only new thing is that both  $V_k$  and gauge group element  $g$  are super-fields.

### How to feed information about classical physics of space-time sheet to chiral and vector super-fields?

The new view about super fields need not be consistent with the geometric interpretation assigned to the chiral multiplets in the standard SUSY without some modifications.

1. The geometric interpretation of Kähler potential and super-potential are very attractive features of ordinary SUSY. The most general interpretation in TGD framework would be as the WCW Kähler function  $K$  and holomorphic function  $f$ , whose real part added to  $K$  does not affect its metric but changes the maxima of Kähler function.
2. In standard SUSYs the scalar parts of chiral fields give rise to Higgs expectation values and internal consistency arguments force the manifold of Higgs expectation values to be Kähler or even quaternionic Kähler manifold with coordinates interpreted as Higgs field. In TGD framework Higgs is  $CP_2$  vector which brings in additional constraint.  $CP_2$  is quaternionic Kähler manifold but  $CP_2$  coordinates do not allow interpretation as Higgs field.  $CP_2$  gamma matrices induced to  $S^1$  giving rise to a constant gamma matrix could be however identified as  $S^1$  component of vector potential identifiable as Higgs vacuum expectation contributing to the mass of a given particle besides the dominating contribution coming from p-adic thermodynamics.
3. In the model based on ordinary  $\mathcal{N} = 1$  SUSY each particle would correspond to its own  $\mathcal{N} = 1$  multiplet so that a Cartesian power of  $CP_2$ s would define the quaternionic manifold. This conforms with the geometric picture provided by the replacement of light-like 3-surfaces with braid strands in which a Cartesian power of  $\delta M_{\pm}^4 \times CP_2$  effectively replaces WCW.
4. The new view about super fields requires the replacement of the constant  $S^1$  component of the super gauge potential with a diagonal matrix whose eigenvalues depend on the mode of spinor field characterized by the theta parameter. Quite generally, super-symmetry breaking results from the replacement of the mass parameter  $m$  in  $D$  with a diagonal operator whose eigenvalues  $m_k$  give the masses assignable to the modes depending on the spinor mode. Mathematically the genuine  $S^1$  mass term determined by p-adic thermodynamics can be distinguished from a small Higgs expectation coded by  $S^1$  vector potential by comparing particles with different charges.

The induced Kähler form defining zero modes is so essential for quantum TGD at the fundamental level that the coding of at least part of this information to the chiral action is a highly desirable feature. This seems possible.

1. The overall renormalization factor of the chiral super field cannot carry the information about the geometry of the space-time sheet. The vector super-field vertices involving vector particles are obtained as chiral loops and the normalization factors from the vertices involving  $N$  vectors and 2 chiral particles cancel their inverses associated with the chiral propagators. Hence the possible renormalization of the generalized Dirac action has no physical implications. This is one of the nice outcomes of emergence concept.
2. One can however add to the induced gauge potentials associated with the space-time sheet to the super gauge potential as its classical parts. It is important to notice that  $X^4$  coordinates would appear as parameters constant with respect to  $p_k$  since  $p_k$  would correspond to  $M^4$  coordinate for the tip of  $CD$  rather than space-time coordinate. The standard interpretation would be as slowly varying background fields.
3. The information about vacuum degeneracy coded by the modified gamma matrices could be coded by replacing the operator  $D$  with that appearing in the modified Dirac action and assigned to the maximum of Kähler function. Note that this would bring in two color charges  $Q_i$ . The modified gamma matrices appearing in it would behave as constants with respect to  $p_k$  and  $Q_k$ . Somewhat surprisingly, zero energy ontology would make it possible to feed all information about the classical physics of the space-time sheet without losing Poincare invariance.

### 11.7.8 Could QFT limit be finite?

Could the resulting theory be finite without hyperbolic and mass scale cutoffs in UV region? Consider first general arguments without any resort to the proposed definition of TGD counterparts of super-fields.

1. Non-renormalization theorems allow to expect that a cancelation of quadratic infinities takes place as a consequence of super-symmetry. Cancelation of quadratic divergences in the bosonic propagators means that there is no need to assume that hyperbolic cutoffs are different for time-like and space-like momenta.
2. There are arguments suggesting that  $N = 8$  SUGRA is UV finite. Since the number of super-symmetries in quantum TGD is even higher than in  $N = 8$  super-gravity, the theory might be also UV finite. If infinities cancel, the theory without UV cutoff for the mass scale and hyperbolic angle could provide an excellent approximation to the theory. Also the standard prescription for calculating loop integrals might make sense if this is the case. Geometric arguments support the presence of the cutoffs but one must remain critical.
3. Super-symmetry alone does not guarantee finiteness since it is possible to define extremely general SUSY actions in terms of integrals of functions of super-space integrated over super-space. Chiral action should have some additional symmetries not possessed by super-symmetric counter-terms. Chiral action is quadratic in chiral super-field meaning the absence of self couplings of the chiral super field. Linear superposition of the solutions is certainly a very special symmetry and very essential for the perturbation theory. QFT limit is obtained by integrating over the quantum fluctuations in WCW degrees of freedom for a maximum of Kähler function. Therefore Kähler potential naturally corresponds to WCW Kähler potential at its maximum and depends only on zero modes. This would conform with the fact that only second derivatives of Kähler potential (Kähler metric) appear in the Kähler potential. Also R-parity arguments favor this form.
4. Also for the proposed TGD inspired identifications of super-fields, the cancelation of UV divergences should be essentially algebraic and due to the cancelation of chiral contributions from the loops contributing to the vector super-field propagators and vertices. Also for the emerging bosonic effective action same mechanism should be at work. The renormalization theorems state that the only renormalizations in SUSYs are wave function renormalizations. In the case

of bosonic propagators loops therefore mean only the renormalization of the propagator. In the recent case only the chiral loops are included so that the situation is analogous to Abelian YM theory or  $\mathcal{N} = 4$  super YM theory, where the beta functions for gauge couplings vanish. Hence one might hope that also now wave function renormalization is the only effect so that the radiatively generated contribution should be proportional to the standard form of the vector propagator. The worst that can occur is logarithmically diverging renormalization of the propagator which occur in many SUSYs. The challenge is to show that logarithmic divergences possibly coming from the  $\theta^d$ ,  $d = 1, 2$ , parts of the chiral super-field cancel. The condition for this cancelation is purely algebraic since the coupling to  $k = 2$  part is gradient coupling so that the leading divergences have same form.

5. It could happen that the contributions from  $d \leq 2$  cancel exactly as they do in SUSYs but the contributions from the field components with  $d > 2$  give a non-vanishing and certainly finite contribution. If this were the case then the exotic chiral field components with propagators behaving like  $1/p^d$ ,  $d > 2, \dots$  would make possible the propagation for the components of the vector super-field.

### 11.7.9 Can one understand p-adic coupling constant evolution as a prediction of QFT limit?

The precise formulation of the p-adic coupling constant evolution is one the basic challenges of quantum TGD. The best that one can hope is the deduction of p-adic thermodynamics and p-adic length scale hypothesis as well as p-adic coupling constant evolution from QFT limit alone.

For the simple form of the QFT limit involving  $M^4 \times S^1$  gamma matrices in the definition of  $D$ , p-adic length scale could make itself visible via the mass parameters and the contribution of the Higgs field appearing as  $S^1$  part of the gauge potential. This is of course just feeding in the results of p-adic thermodynamics. Gauge couplings predicted by the emergence would depend on these parameters but the coupling constant evolution would reflect only the effects of mass parameters on it.

4-D spin glass analogy is one of the basic visions about the physics of quantum TGD. In the theory of spin glasses ultrametric topology possessed also by p-adic number fields emerges as a topology of the energy landscape consisting of the minima of free energy. In TGD framework the space for the maxima of Kähler function could obey ultrametric topology with the value of prime  $p$  fixed by the scale of  $CD$  in question and given by a power of 2. Therefore one has good hopes that for small enough sub- $CD$ s of a given  $CD$  the failure of the strict non-determinism implies p-adic coupling constant evolution. p-Adic thermodynamics determining particle masses cannot of course follow from QFT limit since it relates to the space-like space-time regions (locally  $CP_2$  type vacuum extremals) defining the generalized Feynman diagrams. By combining this vision and the QFT limit with maximal information feed about the space-time sheet gives hopes about achieving more ambitious goals.

1. If one replaces  $D$  with the actual measurement interaction term, all information about the space-time sheet within a given  $CD$  is feeded via modified gamma matrices  $\hat{\Gamma}^\alpha = \Gamma^k \partial L_K / \partial_\alpha h^k$  in as effective slowly varying background fields. The propagators reflect directly the local space-time dynamics, and one obtains a distribution of scattering amplitudes as a function of the point of the space-time sheet within a given  $CD$ . A 4-D distribution for the values of gauge coupling constants is predicted whereas 1-D evolution or even discrete p-adic evolution would be quite enough.
2. Space-time surfaces decompose into connected Minkowskian regions surrounding wormhole throats (basins for the local slicings by light-like 3-surfaces parallel to the throats) and these regions naturally correspond to coherence regions at QFT limit. A space-time integral defining a quantum superposition of the amplitudes associated with various points of the coherence region looks like a physically natural mathematical object to consider. Only the kinetic terms for vector super-field would involve the weighting over the coherence region. Ideal weighting depends on zero modes only and therefore cannot depend on the induced metric.
  - (a) If the weighting is defined by Kähler action density, normalization is not required and would lead to difficulties when the Kähler action vanishes. This implies the proportionality of emerging bosonic kinetic terms to  $1/g_K^2$  so that propagators and also gauge coupling

strengths included by definition to the propagators are proportional to  $g_K^2$ . The basic property of emergence is that the dependence of Feynman diagrams on  $1/g_K^2$  coming from the modified gamma matrices cancels out in perturbation theory. This is a nice feature consistent with the idea that the propagator for the small deformations of 3-surfaces corresponds to the WCW contravariant Kähler metric proportional to  $g_K^2$  [?]. The counterparts of the gauge couplings identified in terms of the inverses of propagators for the vector super-field components obtained in this manner would depend on the p-adic length scale  $L_p \propto \sqrt{p}$ ,  $p \simeq 2^k$ , for the smallest  $CD$  containing the coherence region. One can criticize this weighting scheme. The ideal weighting scheme should depend on zero modes ( $J_{\alpha\beta}$ ) only but this weighting scheme depends on the induced metric. Huge amount of information is needed and a concrete connection with the view about generalized Feynman graphs is lacking. Note also that the properties of elementary particles reflecting themselves at the level of propagators would depend on the macroscopic field patterns of Kähler electric field.

- (b) The idea that light-like 3-surfaces meet at partonic two-surfaces  $X^2$  identified as their intersections of wormhole throats with the light-like boundaries of  $CD$ s would suggest only 2-D weighting over partonic 2-surfaces with Kähler action replaced by magnetic flux density  $\frac{1}{g_K} J \sqrt{g_2}$ ,  $J = J^{\alpha\beta} \epsilon_{\alpha\beta}$ . The dependence on the induced metric is only apparent.  $1/g_K$  factor must be included to get dimensions correctly. This weighting depends on zero modes only. The dependence of the coupling constants on the p-adic size scale of  $CD$  comes out naturally, and only the information from the scales relevant to elementary particles affect propagators and couplings. As in the previous case, non-trivial interference effects are possible since the sign of  $J$  varies. The only information about the preferred extremals of Kähler action is about the derivatives  $\partial_\alpha h^k$  at  $X^2$  appearing in  $\hat{\Gamma}^\alpha$ . In the calculation of the super-vector field propagators the information about the modified gamma matrices at *both* ends of  $X_l^3$  is needed and the weighting would be over the both ends.
- (c) One must decide whether to perform the weighting for the kinetic term of vector super-field action or for the loop integrals defining the corresponding propagators. Spin glass analogy would suggest the first option. The weighting the kinetic term would be proportional to  $x^2/g_K^2$ , where  $x$  is a numerical parameter characterizing the net result of the weighting. The emerging propagators would be proportional to  $g_K^2/x^2$  and  $g_K^2$  proportionality is indeed what one expects. For the latter option propagator would be proportional to  $x^2/g_K^2$ , which does not make sense unless one considers the rather remote possibility that electric-magnetic duality relates the two weightings. The value of  $x$  is expected to be smallest for homologically trivial partonic 2-surfaces (Kähler magnetic charge vanishes). Gauge coupling strengths would be therefore smallest for magnetic monopoles, which looks somewhat counter-intuitive if one thinks in terms of electric-magnetic duality. On the other hand, since the propagator for the deformations of 3-surface is contravariant Kähler metric of WCW becoming singular near vacuum extremals and since the kinetic term of Kähler action approaches zero near vacuum extremals, one expects gauge couplings to grow large near vacuum extremals since they are inversely proportional to the scale of the kinetic term. Also asymptotic freedom conforms with this result since in very short length scales magnetically charged string like objects are expected to replace space-time sheets as basic objects whereas long length scales correspond to nearly vacuum extremals.

A cautious conclusion is that the weighting scheme based on Kähler magnetic flux is the correct choice.

3. p-Adic coupling constant evolution for the propagator is obtained in a manner consistent with what has been discussed in [?]. If virtual boson momenta in a given half octave of masses labeled by integer  $k$  correspond to  $CD$  labeled by this integer. Since the coherence region surrounding the propagating wormhole throat is contained inside a  $CD$  characterized by this size scale, the scale of  $CD$  indeed defines the p-adic length scale in question. Since the propagator by definition is proportional to the coupling strength also coupling constant evolution is coded in this manner. The difference to earlier picture is that  $\alpha_K$  proportionality means that the loops defining propagator must be of order one or larger. In the model based on hyperbolic cutoff the cutoff guaranteed the desired value.



4. The failure of the strict determinism for Kähler action suggests that for the practical purposes the coherence regions must be replaced with an ensemble of local preferred extremals of Kähler action. The dependence of the modified gamma matrices defined by the Kähler action on the space-time point is analogous to a similar dependence of the coupling constant parameters of the spin glass Hamiltonian. The vacuum functional  $\exp(K)$  for the coherence region defines the counterpart for the real square root of the density matrix and the sum over the preferred extremals weighted by  $\exp(K)$  for the coherence region defines the analog of statistical average.

### 11.7.10 Is the QFT type description of gravitational interactions possible?

In TGD Universe graviton is necessarily a bi-local object and the emission and absorption of graviton are bi-local processes involving two wormhole contacts: a pair of particles rather than single particle emits graviton. This is definitely something new and defies a description in terms of QFT limit using point like particles. Graviton like states would be entangled states of vector bosons at both ends of string so that gravitation could be regarded as a square of YM interactions in rather concrete sense. The notion of emergence would suggest that graviton propagator is defined by a bosonic loop. Since bosonic loop is dimensionless, IR cutoff defined by the largest  $CD$  present must be actively involved.

The connection with strings is via the assignment of wormhole contacts at the ends of a stringy curve. Stringy diagrams would not however describe graviton emission. Rather, a generalization of the vertex of Feynman diagram would be in question in the sense that three string world sheets would be glued together along their 1-dimensional ends in the vertex. This generalizes similar description for gauge interactions using Feynman diagrams. In the microscopic description point like particles are replaced with 2-D partonic surfaces so that in gravitational case one has stringy 3-surfaces at vertices.

At QFT limit one can hope a description as a bi-local process using a bi-local generalization of the QFT limit so that stringy degrees of freedom need not be described explicitly. There are hopes about success, since these degrees of freedom have been taken into account in the spectrum of modes of the induced spinor field and reflect themselves as quantum numbers labeling fermionic oscillator operators. Also modified gamma matrices feed information about space-time surface to the theory.

#### What one really means with strings?

Before continuing is it is good take critical attitude to the proposed picture. What one really means with string is the first question.

1. Stringy curves appear in in the slicing of the space-time sheet around wormhole throat to light-like 3-surfaces labeled by the points of string. Hamilton-Jacobi coordinates [K9] suggest that the  $M^4$  projections of these curves light-like so that the curves would be space-like.
2. For string like objects obtained as deformations of cosmic strings  $X^2 \times Y^2 \subset M^4 \times CP_2$  one can assign Kähler magnetic flux flowing along the stringy curves. These curves should define a special class of stringy curves.
3. If the basin for the slicing by light-like 3-surfaces for a given wormhole throat has an outer boundary at which induced Kähler form vanishes (it is not obvious that this can be the case), one can ask whether stringy curves effectively end at the boundary of the basin or what happens? Magnetic flux conservation does not allow to assign magnetic flux to the stringy curves now. The analogy with field lines gravitational scalar potential suggests a possible answer. All wormhole throats would act as sources for these lines identifiable as field lines of a gradient vector field. Basins would not actually have any boundaries since the extrema of the potential would consist in the generic case of a discrete set of points. Whether stringy curves really have something to do with field lines of a gradient of gravitational potential must be however left an open question.
4. Despite the emergence of stringy picture, string model as such does not seem to help much since the graviton emission vertex is completely different from that in string models.

A physically attractive realization of the braids - and more generally- of slicings of space-time surface by 3-surfaces and string world sheets, is discussed in [?] by starting from the observation that TGD defines an almost topological QFT of braids, braid cobordisms, and 2-knots. The boundaries of

the string world sheets at the space-like 3-surfaces at boundaries of  $CD$ s and wormhole throats would define space-like and time-like braids uniquely.

The idea relies on a rather direct translation of the notions of singular surfaces and surface operators used in gauge theory approach to knots [?] to TGD framework. It leads to the identification of slicing by three-surfaces as that induced by the inverse images of  $r = \text{constant}$  surfaces of  $CP_2$ , where  $r$  is  $U(2)$  invariant radial coordinate of  $CP_2$  playing the role of Higgs field vacuum expectation value in gauge theories.  $r = \infty$  surfaces correspond to geodesic spheres and define analogs of fractionally magnetically charged Dirac strings identifiable as preferred string world sheets. The union of these sheets labelled by subgroups  $U(2) \subset SU(3)$  would define the slicing of space-time surface by string world sheets. The choice of  $U(2)$  relates directly to the choice of quantization axes for color quantum numbers characterizing  $CD$  and would have the choice of braids and string world sheets as a space-time correlate.

### What one really means with gravitons?

One can also ask what one really means with graviton. The identification of graviton is indeed far from obvious.

1. Wormhole throats and contacts allow  $J = 2$  states but they couple only to states which corresponds to  $d \geq 2$  monomials of theta so that couplings to the fermions are absent.
2. TGD predicts a hierarchy of string like objects of all possible sizes and these are good candidates for graviton like states. The hierarchy of Planck constants and the huge values of gravitational Planck constant suggests that gigantic gravitons identifiable as stringy curves connecting particles at astrophysical distances are possible. The emission of dark graviton would be bi-local process in astrophysical length scales and would look locally like an emission of gauge boson.
3. One can of course argue it is not clear whether stringy gravitons represent hadron like objects responsible for strong gravitation below relevant p-adic length scale rather than genuine gravitons. For instance, the identification of elementary particles in terms of  $CP_2$  type extremals forces to ask whether gravitons could correspond to pieces of  $CP_2$  type extremals connecting positive and negative energy space-time sheets with a wormhole contact having two pairs of wormhole throats so that spin two states would become possible. If this generalization is accepted, one must also accept the possibility of wormhole contacts with arbitrary number of throat pairs. One can also wonder what is the origin of Planck length which is roughly  $10^4$  times shorter than  $CP_2$  length. For instance, could it have purely geometric interaction characterizing the distance between these wormhole contacts?

With this identification graviton emission at elementary particle level could be seen as a creation of a virtual wormhole throat pair inside wormhole contact formed by fermion and anti-fermion and making possible emission of graviton. One can also consider a distribution of wormhole throat pairs inside wormhole created in this manner in which case  $1/G_N$  would characterize the probability for the appearance of wormhole throat pair.

4. Graviton must be generalized to a super-field and bi-locality suggests that this field is a bi-local composite of super gauge fields in some sense. Ordinary graviton would be only single component of this field.

To sum up, it is far from clear what graviton precisely is and gauge-theory-gravitation correspondence suggests that there is a rich spectrum of graviton like states. Despite this one can characterize rather precisely what the description of gravitational interaction at QFT limit must be by using general symmetry principles and basic structure of quantum TGD.

### Could bi-local QFT allow to describe gravitation as a square of gauge interactions?

The key question is whether one can generalize the formalism of QFT limit to describe also gravitational interactions. The first guess is that in some sense gravitation is a square of YM interactions. This statement has a precise content in some string theories. Also the scattering amplitudes of  $N = 8$  super-gravity allow a construction in terms of  $N = 4$  SYM amplitudes. In the recent case gravitation as a square of YM theory would mean that graviton propagator emerges from vector super-field

propagators assignable at the ends of the gravitonic string. Vector propagators would in turn emerge from chiral super-field propagators.

The bi-local character of the basic process suggests that a bi-local generalization of QFT limit is needed to describe gravitation. In fact, at the long length scale limit of the theory the appearance of second derivatives in the curvature scalar could be seen as a signature of bi-locality at fundamental level. Bi-locality brings in the notion of distance and the metric description of gravitation indeed assumes that distances are dynamical. Note that also the typical experimental arrangements for detecting gravitons are bi-local (typically the variation of the distance between the ends of a metal bar is measured).

1. Bi-locality would suggest that one has a pairing of the chiral actions to a bi-local action. Whether the vector bosons at the ends of graviton string move collinearly or not is a non-trivial question. Experimentation with the candidates for the bilinear gravitational action shows that the simplest theory results when collinearity assumption is given up. It is also far from clear whether collinearity assumption allows any internally consistent mathematical realization: the problem is that by collinearity graviton propagator becomes proportional to  $1/p^4$  and one should somehow eliminate one  $1/p^2$  factor. If one gives up collinearity, one obtains a bosonic loop integral with vector boson momenta  $p - k$  and  $k$ . Graviton kinetic term emerges from a loop of two bosons and is therefore dimensionless so that IR cutoff  $L$  is necessary in order to obtain  $p^2 L^2$  type kinetic term and finiteness. The IR cutoff comes naturally as the size scale  $L$  of the largest  $CD$  involved and appears also as scaling factor of the action by purely dimensional reasons and disappears naturally from the interaction vertices.
2. Graviton would correspond to a bi-local composite of super gauge fields acting as operators  $V(\theta_i, \partial_{\theta_i})$ ,  $i = 1, 2$ , on the chiral super-fields at the ends of the string and graviton propagation should reduce to vector boson propagation just as vector boson propagation reduces to fermion pair propagation. General gauge invariance at the level of space-time sheet is not a problem. At the level of  $M^4$ , whose coordinates label the positions for the tips of  $CD$  the possibility to choose preferred  $M^4$  coordinates guarantees general coordinate invariance trivially. The elimination of non-physical graviton polarizations for massless gravitons is achieved by the ordinary gauge invariance. In this conceptual framework elimination of non-physical graviton polarization does not have obvious connection with general coordinate invariance. The properties of the slicings by light-like 3-surfaces suggest this connection.
3. At the point like limit the emission of gravitons is described by an interaction term of form  $T^{\alpha\beta} \delta g_{\alpha\beta}$ . This expression should have a bi-local gauge invariant generalization. The energy momentum tensor for Dirac action suggests the following remarkably simple expression for the interaction action  $L_{gr}$  in super space.

$$L_{gr} = K \bar{\Psi} D^A \Psi \times \bar{\Psi} D_A \Psi . \quad (11.7.16)$$

A summation over the contracted index pairs is understood in the formula. The theta parameters associated with the two actions are regarded as independent Grassmann variables.

4. If the vector boson momenta at the ends of graviton string vary freely apart from the constraint that they sum up to the momentum of the virtual graviton,  $K$  must be of form  $K = kL^2$  to compensate the dimension  $1/L^2$  coming from the two  $D_A$ s.  $L$  naturally corresponds to IR cutoff defined by the size of the largest  $CD$  involved. The bosonic loop giving graviton propagator at the IR limit is dimensionless so that the resulting propagator must be proportional to  $1/(p^2 L^2)$  so that the powers of  $L$  cancel each other in the propagators.  $D_A = p_A + Q_A + V_A$  is the covariant derivative corresponding to a particular momentum component. Note that also color charge (color hyper charge or isospin) is included and is present for massive particles. Since only covariant derivatives appear, the expression is manifestly super gauge invariant.
5. The integration over the theta parameters gives factors  $D = \hat{\Gamma}^A D_A / M$  for each integrated pair of theta parameters. Here  $M$  is a parameter with dimensions of mass to make  $D$  dimensionless and

$CP_2$  is the most natural guess for its value. The resulting action for graviton has the following form

$$\begin{aligned}
L_{gr} &= \frac{K}{M^2} \bar{\Psi} O^A \Psi \times \bar{\Psi} O_A \Psi , \\
O^A &= \frac{D^{\rightarrow} D^{A\rightarrow} - D^{\leftarrow} D^{A\leftarrow}}{M} , \\
D^{\leftarrow} &= \frac{D_A^{\leftarrow} \hat{\Gamma}^A}{M} , \quad D^{\rightarrow} = \frac{\hat{\Gamma}^A D_A^{\rightarrow}}{M} , \quad D = \frac{\hat{\Gamma}^A D_A}{M} .
\end{aligned}
\tag{11.7.17}$$

The  $1/p^2 L^2$  from the IR cutoff for the loop integral defining the emergent graviton propagator given by a dimensionless bosonic loop cancels  $L^2$  from factor  $kL^2/M^2$  and  $kM^2$  should be proportional to  $G_N$ .

6. The tensor structure of the graviton vertex resulting from  $DD^A$  in the lowest order seems to be correct.  $\hat{\Gamma}^A D^{B\rightarrow}$  *resp.*  $\hat{\Gamma}^A D^{B\leftarrow}$  is the analog of energy momentum tensor and in the lowest order gives rise to the desired proportionality of the gravitational coupling to momentum. Since graviton is emitted by a pair of particles the proportionality to the momenta of both particles is natural. Note that only the momenta associated with the vector bosons defining the emitted graviton-like particle are collinear, not the momenta of the emitting particles at the ends of the string. The bilinear  $D_B \otimes D_C$  is the counterpart of  $\delta g_{\alpha\beta}$  and polarization tensor of graviton. Both  $D_B$  and  $D_C$  are contracted with the analog of the energy momentum tensor.
7. Ordinary graviton must correspond to electro-weak  $U(1)$  for which coupling is to fermion number. The mixing of  $U(1)_Y$  and  $U(1) \subset SU(2)$  should be completely absent for gravitons. In other words, the corresponding value of Weinberg angle must vanish:  $\sin^2(\theta_{W,gr}) = 0$  implying  $m_Z = m_W$  in gravitonic propagation. The graviton analogs formed from massless gluons would have a finite interaction range by confinement and weak gravitons would be massive so that no dramatic new effects are predicted.

When one feeds the information about space-time surface into the theory additional complications arise since the modified gamma matrices  $\hat{\Gamma}^\alpha(x) = \Gamma^k \partial L_K / \partial_\alpha h^k$  would replace the  $M^4 \times S^1$  gamma matrices and one must integrate over the points  $x$ . As found, the condition that weighting scheme depends on zero modes only (is symplectic invariant at the level of WCW) fixes it uniquely to a weighting by magnetic flux at the intersections of light-like wormhole throats with the light-like boundaries of  $CD$  relevant for the  $p$ -adic length scale defined by the virtual momentum squared.

1. Bi-locality suggests that both ends of string correspond to their own partonic 2-surfaces so that both ends involve weighting by the Kähler magnetic flux  $J\sqrt{g}/g_K$ .  $J = J^{\alpha\beta} \epsilon_{\alpha\beta}$ . Since  $J$  vanishes for vacuum regions and since also its sign varies, this is expected to bring in four identical reduction factors -call them  $x$ - to the kinetic term of graviton.
2. The defining property of the emergence is that the variation of the scale of  $\hat{\Gamma}^A$  is compensated by the variation of the scale of the propagator so that the proportionality of  $\hat{\Gamma}^A$  to  $1/g_K^2$  is not seen in scattering amplitudes.
3. Again one must decide whether the weighting is performed for the calculation of the propagator or whether one uses the bosonic propagators already calculated with corresponding weightings at the ends of lines. Only the latter option conforms with the idea about gravitation as square of gauge interactions predicting  $\alpha_K^2$ -proportionality for the graviton propagator. From the general proportionality of bosonic propagators to  $g_K^2/x^2 \propto \alpha_K$  one has the order of magnitude estimate

$$16\pi G_N \sim \frac{kg_K^4}{x^4 M^2} \sim \frac{k\alpha_K^2}{M^2} .
\tag{11.7.18}$$

$16\pi G$  comes from the fact that it appears in the linearized Einstein's equations as the coefficient of energy momentum tensor. If  $k$  does not depend on  $\hbar$  then  $\alpha_K \propto 1/\hbar$  and  $M \propto \hbar/R$  correctly predicts that  $G_N$  does not depend on  $\hbar$ . Using  $\alpha_K \simeq 1/137$  and  $M = m(CP_2) = .2437 \times 10^{-3} m_{Pl}$  [K39] one obtains the very rough estimate  $k = (m(CP_2)/\alpha_K m_{Pl})^2 = .056$ .

4. Note that the solutions of field equations in the static limit when the situation resembles formally electrostatics, gravitational coupling strength is estimated classically to be of order  $CP_2$  length squared [K9]. Since the value of  $CP_2$  mass (and thus length) is firmly fixed by elementary particle mass calculations [K39], this results could be seen as a serious objection against TGD. One could say that the weighting provides a "screening mechanism" reducing the naive value of the gravitational coupling strength.

This picture allows to interpret the cutoff for  $\mathcal{N}$  as a cutoff for the maximal number of points of the partonic 2-surface carrying fermionic quantum numbers: essentially a cutoff in measurement resolution is in question. The super-symmetric excitations of graviton can be interpreted microscopically as multi-string states but looking like a single string in the spatial measurement resolution provided by single partonic 2-surface.

### Could one apply the formalism at fundamental level?

There are good motivations for asking whether this formalism - when appropriately generalized- could apply to the basic quantum TGD.

1. Only the data about partonic 2-surfaces are feeded into the vertices so that the assumption that space-time sheets are representable as graphs for maps from  $M^4$  to  $CP_2$  is not actually needed. The information about the interior topology of the space-time sheet is un-necessary and the effective 2-dimensionality simplifies the situation enormously. Note however that the initial values of derivatives of  $H$ -coordinates at partonic 2-surfaces are needed.
2. The cutoff for  $\mathcal{N}$  has interpretation as a cutoff for the maximal number of points of the partonic 2-surface carrying fermionic quantum numbers: essentially a cutoff in measurement resolution is in question. Already  $\mathcal{N} = 2$  cutoff is expected to be a good approximation since higher theta monomials give rise to short range forces.
3. The super-symmetric excitations of graviton can be interpreted microscopically as multi-string states but looking like a single string in the spatial measurement resolution provided by single partonic 2-surface. Therefore strings split to space-like braids at fundamental level. The duality between these space-like braids and light-like braids at light-like 3-surfaces might be important.
4. The generalization should take into account the fact theta parameters correspond to different points of  $X^2$  and that the wormhole throats associated with the bosonic wormhole contacts are not one and same thing. These effects are expected to be small unless the size of the wormhole is very large as it is for anyon-like wormhole throats with macroscopic size containing states with a high fermion number [?]. Also global data such as the moduli characterizing the conformal equivalence class of partonic 2-surface are needed in order to describe family replication phenomenon at the fundamental level. The description of color quantum numbers at fundamental level introduces additional complications. The functional integral over WCW must be performed and gives rise to non-perturbative effects when a large number of maxima of Kähler function must be included.

## 11.8 A more detailed summary of Feynman diagrammatics for emergence

In the following the Feynman diagrammatics for Dirac action coupled to gauge potential is sketched briefly and some comments on generalization to the super-symmetric case are made.

### 11.8.1 Emergence in absence of super-symmetry

The resulting Feynman diagrammatics deserves some more detailed comments.

1. Consider first the exponent of the action  $\exp(iS_c)$  resulting in fermionic path integral. The exponent

$$\exp\left[i \int d^4x d^4y \bar{\xi}(x) G_F(x-y) \xi(y)\right] = \exp\left[i \int d^4k \bar{\xi}(-k) G_F(k) \xi(k)\right]$$

is combinatorially equivalent with the sum over  $n$ -point functions of a theory representing free fermions constructed using Wick's rules that is by connecting  $n$  Grassmann spinors and their conjugates in all possible ways by the fermion propagator  $G_F$ .

2. The action of

$$\exp\left[i \int d^4x \frac{\delta}{\delta \bar{\xi}(x)} \gamma \cdot A(x) \frac{\delta}{\delta \xi(x)}\right] = \exp\left[i \int d^4k d^4k_1 \frac{\delta}{\delta \bar{\xi}(k-k_1)} \gamma \cdot A(-k) \frac{\delta}{\delta \xi(k_1)}\right]$$

on diagrams consisting of  $n$  free fermion lines gives sum over all diagrams obtained by connecting fermion and anti-fermion ends of two fermion lines and inserting to the resulting vertex  $A(-k)$  such that momentum is conserved. This gives sum over all closed and open fermion lines containing  $n \geq 2$  boson insertions. The diagram with single gauge boson insertion gives a term proportional to  $A_\mu(k=0) \cdot \int d^4k k^\mu k^{-2}$ , which vanishes.

3.  $S_c$  as obtained in the fermionic path integral is the generating functional for connected many-fermion diagrams in an external gauge boson field and represented as sum over diagrams in which one has either closed fermion loop or open fermion line with  $n \geq 2$  bosons attached to it. The two parts of  $S_c$  have interpretation as the counterparts of YM action for gauge bosons and Dirac action for fermions involving arbitrary high gauge invariant  $n$ -boson couplings besides the standard coupling. An expansion in powers of  $\gamma^\mu D_\mu$  is suggestive. Arbitrary number of gauge bosons can appear in the bosonic vertices defined by the closed fermion loops and gauge invariance must pose strong constraints on the bosonic part of the action if expressible in terms of bosonic gauge invariants. The closed fermion loop with  $n = 2$  gauge boson insertions defines the bosonic kinetic term and bosonic propagator. The sign of the kinetic terms comes out correctly thanks to the minus sign assigned to the fermion loop.
4. Feynman diagrammatics is constructed for  $S_c$  using standard Feynman rules. In ordinary YM theory ghosts are needed for gauge fixing and this seems to be the case also now.
5. One can consider also the presence of Higgs bosons. Also the Higgs propagator would be generated radiatively and would be massless for massless fermions as the study of the fermionic self energy diagram shows. Higgs would be necessary  $CP_2$  vector in  $M^4 \times CP_2$  picture and  $E^4$  vector in  $M^8 = M^4 \times E^4$  picture. It is not clear whether one can describe Higgs simply as an  $M^4$  scalar. Note that TGD allows in principle Higgs boson but - according to the recent view - it does not play a role in particle massivation.

### 11.8.2 Some differences from standard Feynman diagrammatics

The diagrammatics differs from the Feynman diagrammatics of standard gauge theories in some respects.

1. 1-P irreducible self energy insertions involve always at least one gauge boson line since the simplest fermionic loop has become the inverse of the bosonic propagator. Fermionic self energy loops in gauge theories tends to spoil asymptotic freedom in gauge theories. In the recent case the lowest order self-energy corrections to the propagators of non-abelian gauge bosons correspond to bosonic loops since fermionic loops define propagators. Hence asymptotic freedom is suggestive.

2. The only fundamental vertex is  $AF\bar{F}$  vertex. As already found, there seems no point in attaching to the vertex an explicit gauge coupling constant  $g$ . If this is however done  $n$ -boson vertices defined by loops are proportional to  $g^n$ . In gauge theories  $n$ -boson vertices are proportional to  $g^{n-2}$  so that a formal consistency with the gauge theory picture is achieved for  $g = 1$ . In each internal boson line the  $g^2$  factor coming from the ends of the bosonic propagator line is canceled by the  $g^{-2}$  factor associated with the bosonic propagator. In S-matrix the division of the bosonic propagator from the external boson lines implies  $g^n$  proportionality of an  $n$ -point function involving  $n$  gauge bosons. This means asymmetry between fermions and bosons unless one has  $g = 1$ .  $g = 1$  above means  $g = \sqrt{\hbar_0}$ . Since fermionic propagator is proportional to  $\hbar_0^0$  and since loop integral involves the factor  $1/\hbar_0$ , the dimensions of bosonic propagator and radiatively generated vertices come out correctly. The counterparts of gauge coupling constants could be identified from the amplitudes for 2-fermion scattering by comparison with the predictions of standard gauge theories. The small value of effective gauge coupling  $g$  obtained in this manner would correspond to a large deviation of the normalization factor of the radiatively generated boson propagator from its standard value.
3. Furry's theorem holding true for Abelian gauge theories implies that all closed loops with an odd number of Abelian gauge boson insertions vanish. This conforms with the expectation that 3-vertices involving Abelian gauge bosons must vanish by gauge invariance. In the non-abelian case Furry's theorem does not hold true so that non-Abelian 3-boson vertices are obtained.

### 11.8.3 Generalization of the formalism to the super-symmetric case

In principle the generalization of the formula of generalized Feynmann diagrammatics to super-symmetric case at QFT limit of TGD is straightforward.

1. Consider first the standard formalism making sense only for  $\mathcal{N} = 1$  case in TGD framework. In this case the Kähler potential  $K(\Phi^\dagger, \exp(-V)\Phi)$  replaces Dirac action coupled to gauge potentials and the functional integral at the first step is over super-fields assigned to the fermions. Theta integrations gives the Lagrangian as function of components of super-fields and the free-field functional integral over the fields appearing in  $\Phi$  and  $\Phi^\dagger$  gives the action as a functional of gauge boson fields and their super-partners appearing in  $V$ . All vertices and propagators are expressible in terms of loops of fermions and their super-partners and gauge couplings and their evolution follow as predictions.
2. For the option based on TGD inspired generalization of super-fields the fundamental action is the generalization of Dirac action. As already found the propagators for chiral field components with  $d$  theta parameters behave as  $k^{-d}$  so that they do not induce divergences in fermionic loops. Also bosonic propagators for field components involving  $d$  thetas behave in similar manner. The possible divergences in the bosonic propagators would vanish by the same mechanism as in ordinary super-symmetry.

In the earlier approach the elimination of UV divergences required the introduction of cutoffs in mass squared and hyperbolic angle characterizing velocity of virtual fermion in the rest system of the virtual boson. The requirement that quadratic divergences are absent in the inverses of the propagators forced the hyperbolic cutoffs to be different for time-like and space-like momenta. The justification for hyperbolic cutoff was in terms of a geometric argument: the causal diamond ( $CD$ ) characterizing virtual fermion must remain inside the  $CD$  defining the IR cutoff. Super-symmetry could imply this cutoff in a smooth manner by the cancelation of the divergences associated with particles and their super-partners as already noticed.

## 11.9 Could $\mathcal{N} = 2$ or $\mathcal{N} = 4$ SUSY be a part of TGD after all?

Whether right-handed neutrinos generate a supersymmetry in TGD has been a long standing open question.  $\mathcal{N} = 1$  SUSY is certainly excluded by fermion number conservation but already  $\mathcal{N} = 2$  defining a "complexification" of  $\mathcal{N} = 1$  SUSY is possible and could generate right-handed neutrino and its antiparticle. These states should however possess a non-vanishing light-like momentum since

the fully covariantly constant right-handed neutrino generates zero norm states. So called massless extremals (MEs) allow massless solutions of the modified Dirac equation for right-handed neutrino in the interior of space-time surface, and this seems to be case quite generally in Minkowskian signature for preferred extremals. This suggests that particle represented as magnetic flux tube structure with two wormhole contacts sliced between two MEs could serve as a starting point in attempts to understand the role of right handed neutrinos and how  $\mathcal{N} = 2$  or  $\mathcal{N} = 4$  SYM emerges at the level of space-time geometry. The following arguments inspired by the article of Nima Arkani-Hamed et al [?] about twistorial scattering amplitudes suggest a more detailed physical interpretation of the possible SUSY associated with the right-handed neutrinos.

The fact that right handed neutrinos have only gravitational interaction suggests a radical re-interpretation of SUSY: no SUSY breaking is needed since it is very difficult to distinguish between mass degenerate spartners of ordinary particles. In order to distinguish between different spartners one must be able to compare the gravitomagnetic energies of spartners in slowly varying external gravimagnetic field: this effect is extremely small.

### 11.9.1 Scattering amplitudes and the positive Grassmannian

The work of Nima Arkani-Hamed and others represents something which makes me very optimistic and I would be happy if I could understand the horrible technicalities of their work. The article Scattering Amplitudes and the Positive Grassmannian by Arkani-Hamed, Bourjaily, Cachazo, Goncharov, Postnikov, and Trnka [?] summarizes the recent situation in a form, which should be accessible to ordinary physicist. Lubos has already discussed the article. The following considerations do not relate much to the main message of the article (positive Grassmannians) but more to the question how this approach could be applied in TGD framework.

#### All scattering amplitudes have on shell amplitudes for massless particles as building bricks

The key idea is that all planar amplitudes can be constructed from on shell amplitudes: all virtual particles are actually real. In zero energy ontology I ended up with the representation of TGD analogs of Feynman diagrams using only mass shell massless states with both positive and negative energies. The enormous number of kinematic constraints eliminates UV and IR divergences and also the description of massive particles as bound states of massless ones becomes possible.

In TGD framework quantum classical correspondence requires a space-time correlate for the on mass shell property and it indeed exists. The mathematically ill-defined path integral over all 4-surfaces is replaced with a superposition of preferred extremals of Kähler action analogous to Bohr orbits, and one has only a functional integral over the 3-D ends at the light-like boundaries of causal diamond (Euclidian/Minkowskian space-time regions give real/imaginary Chern-Simons exponent to the vacuum functional). This would be obviously the deeper principle behind on mass shell representation of scattering amplitudes that Nima and others are certainly trying to identify. This principle in turn reduces to general coordinate invariance at the level of the world of classical worlds.

Quantum classical correspondence and quantum ergodicity would imply even stronger condition: the quantal correlation functions should be identical with classical correlation functions for any preferred extremal in the superposition: all preferred extremals in the superposition would be statistically equivalent [?]. 4-D spin glass degeneracy of Kähler action however suggests that this is probably too strong a condition applying only to building bricks of the superposition.

Minimal surface property is the geometric counterpart for masslessness and the preferred extremals are also minimal surfaces: this property reduces to the generalization of complex structure at space-time surfaces, which I call Hamilton-Jacobi structure for the Minkowskian signature of the induced metric. Einstein Maxwell equations with cosmological term are also satisfied.

#### Massless extremals and twistor approach

The decomposition  $M^4 = M^2 \times E^2$  is fundamental in the formulation of quantum TGD, in the number theoretical vision about TGD, in the construction of preferred extremals, and for the vision about generalized Feynman diagrams. It is also fundamental in the decomposition of the degrees of string to longitudinal and transversal ones. An additional item to the list is that also the states appearing



in thermodynamical ensemble in p-adic thermodynamics correspond to four-momenta in  $M^2$  fixed by the direction of the Lorentz boost. In twistor approach to TGD the possibility to decompose also internal lines to massless states at parallel space-time sheets is crucial.

Can one find a concrete identification for  $M^2 \times E^2$  decomposition at the level of preferred extremals? Could these preferred extremals be interpreted as the internal lines of generalized Feynman diagrams carrying massless momenta? Could one identify the mass of particle predicted by p-adic thermodynamics with the sum of massless classical momenta assignable to two preferred extremals of this kind connected by wormhole contacts defining the elementary particle?

Candidates for this kind of preferred extremals indeed exist. Local  $M^2 \times E^2$  decomposition and light-like longitudinal massless momentum assignable to  $M^2$  characterizes "massless extremals" (MEs, "topological light rays"). The simplest MEs correspond to single space-time sheet carrying a conserved light-like  $M^2$  momentum. For several MEs connected by wormhole contacts the longitudinal massless momenta are not conserved anymore but their sum defines a time-like conserved four-momentum: one has a bound states of massless MEs. The stable wormhole contacts binding MEs together possess Kähler magnetic charge and serve as building bricks of elementary particles. Particles are necessary closed magnetic flux tubes having two wormhole contacts at their ends and connecting the two MEs.

The sum of the classical massless momenta assignable to the pair of MEs is conserved even when they exchange momentum. Quantum classical correspondence requires that the conserved classical rest energy of the particle equals to the prediction of p-adic mass calculations. The massless momenta assignable to MEs would naturally correspond to the massless momenta propagating along the internal lines of generalized Feynman diagrams assumed in zero energy ontology. Masslessness of virtual particles makes also possible twistor approach. This supports the view that MEs are fundamental for the twistor approach in TGD framework.

### Scattering amplitudes as representations for braids whose threads can fuse at 3-vertices

Just a little comment about the content of the article. The main message of the article is that non-equivalent contributions to a given scattering amplitude in  $\mathcal{N} = 4$  SYM represent elements of the group of permutations of external lines - or to be more precise - decorated permutations which replace permutation group  $S_n$  with  $n!$  elements with its decorated version containing  $2^n n!$  elements. Besides 3-vertex the basic dynamical process is permutation having the exchange of neighboring lines as a generating permutation completely analogous to fundamental braiding. BFCW bridge has interpretation as a representations for the basic braiding operation.

This supports the TGD inspired proposal (TGD as almost topological QFT) that generalized Feynman diagrams are in some sense also knot or braid diagrams allowing besides braiding operation also two 3-vertices [?]. The first 3-vertex generalizes the standard stringy 3-vertex but with totally different interpretation having nothing to do with particle decay: rather particle travels along two paths simultaneously after  $1 \rightarrow 2$  decay. Second 3-vertex generalizes the 3-vertex of ordinary Feynman diagram (three 4-D lines of generalized Feynman diagram identified as Euclidian space-time regions meet at this vertex). The main idea is that in TGD framework knotting and braiding emerges at two levels.

1. At the level of space-time surface string world sheets at which the induced spinor fields (except right-handed neutrino [?]) are localized due to the conservation of electric charge can form 2-knots and can intersect at discrete points in the generic case. The boundaries of strings world sheets at light-like wormhole throat orbits and at space-like 3-surfaces defining the ends of the space-time at light-like boundaries of causal diamonds can form ordinary 1-knots, and get linked and braided. Elementary particles themselves correspond to closed loops at the ends of space-time surface and can also get knotted (possible effects are discussed in [?]).
2. One can assign to the lines of generalized Feynman diagrams lines in  $M^2$  characterizing given causal diamond. Therefore the 2-D representation of Feynman diagrams has concrete physical interpretation in TGD. These lines can intersect and what suggests itself is a description of non-planar diagrams (having this kind of intersections) in terms of an algebraic knot theory. A natural guess is that it is this knot theoretic operation which allows to describe also non-planar diagrams by reducing them to planar ones as one does when one constructs knot invariant by reducing the knot to a trivial one. Scattering amplitudes would be basically knot invariants.

"Almost topological" has also a meaning usually not assigned with it. Thurston's geometrization conjecture stating that geometric invariants of canonical representation of manifold as Riemann geometry, defined topological invariants, could generalize somehow. For instance, the geometric invariants of preferred extremals could be seen as topological or more refined invariants (symplectic, conformal in the sense of 4-D generalization of conformal structure). If quantum ergodicity holds true, the statistical geometric invariants defined by the classical correlation functions of various induced classical gauge fields for preferred extremals could be regarded as this kind of invariants for sub-manifolds. What would distinguish TGD from standard topological QFT would be that the invariants in question would involve length scale and thus have a physical content in the usual sense of the word!

### 11.9.2 Could $\mathcal{N} = 2$ or $\mathcal{N} = 4$ SUSY have something to do with TGD?

$\mathcal{N} = 4$  SYM has been the theoretical laboratory of Nima and others.  $\mathcal{N} = 4$  SYM is definitely a completely exceptional theory, and one cannot avoid the question whether it could in some sense be part of fundamental physics. In TGD framework right handed neutrinos have remained a mystery: whether one should assign space-time SUSY to them or not. Could they give rise to something resembling  $\mathcal{N} = 2$  or  $\mathcal{N} = 4$  SUSY with fermion number conservation?

#### Earlier results

My latest view is that *fully* covariantly constant right-handed neutrinos decouple from the dynamics completely. I will repeat first the earlier arguments which consider only fully covariantly constant right-handed neutrinos.

1.  $\mathcal{N} = 1$  SUSY is certainly excluded since it would require Majorana property not possible in TGD framework since it would require superposition of left and right handed neutrinos and lead to a breaking of lepton number conservation. Could one imagine SUSY in which both MEs between which particle wormhole contacts reside have  $\mathcal{N} = 2$  SUSY which combine to form an  $\mathcal{N} = 4$  SUSY?
2. Right-handed neutrinos which are covariantly constant right-handed neutrinos in both  $M^4$  degrees of freedom cannot define a non-trivial theory as shown already earlier. They have no electroweak nor gravitational couplings and carry no momentum, only spin.

The fully covariantly constant right-handed neutrinos with two possible helicities at given ME would define representation of SUSY at the limit of vanishing light-like momentum. At this limit the creation and annihilation operators creating the states would have vanishing anticommutator so that the oscillator operators would generate Grassmann algebra. Since creation and annihilation operators are hermitian conjugates, the states would have zero norm and the states generated by oscillator operators would be pure gauge and decouple from physics. This is the core of the earlier argument demonstrating that  $\mathcal{N} = 1$  SUSY is not possible in TGD framework: LHC has given convincing experimental support for this belief.

#### Could massless right-handed neutrinos covariantly constant in $CP_2$ degrees of freedom define $\mathcal{N} = 2$ or $\mathcal{N} = 4$ SUSY?

Consider next right-handed neutrinos, which are covariantly constant in  $CP_2$  degrees of freedom but have a light-like four-momentum. In this case fermion number is conserved but this is consistent with  $\mathcal{N} = 2$  SUSY at both MEs with fermion number conservation.  $\mathcal{N} = 2$  SUSYs could emerge from  $\mathcal{N} = 4$  SUSY when one half of SUSY generators annihilate the states, which is a basic phenomenon in supersymmetric theories.

1. At space-time level right-handed neutrinos couple to the space-time geometry - gravitation - although weak and color interactions are absent. One can say that this coupling forces them to move with light-like momentum parallel to that of ME. At the level of space-time surface right-handed neutrinos have a spectrum of excitations of four-dimensional analogs of conformal spinors at string world sheet (Hamilton-Jacobi structure).

For MEs one indeed obtains massless solutions depending on longitudinal  $M^2$  coordinates only since the induced metric in  $M^2$  differs from the light-like metric only by a contribution which is

light-like and contracts to zero with light-like momentum in the same direction. These solutions are analogs of (say) left movers of string theory. The dependence on  $E^2$  degrees of freedom is holomorphic. That left movers are only possible would suggest that one has only single helicity and conservation of fermion number at given space-time sheet rather than 2 helicities and non-conserved fermion number: two real Majorana spinors combine to single complex Weyl spinor.

- At imbedding space level one obtains a tensor product of ordinary representations of  $\mathcal{N} = 2$  SUSY consisting of Weyl spinors with opposite helicities assigned with the ME. The state content is same as for a reduced  $\mathcal{N} = 4$  SUSY with four  $\mathcal{N} = 1$  Majorana spinors replaced by two complex  $\mathcal{N} = 2$  spinors with fermion number conservation. This gives 4 states at both space-time sheets constructed from  $\nu_R$  and its antiparticle. Altogether the two MEs give 8 states, which is one half of the 16 states of  $\mathcal{N} = 4$  SUSY so that a degeneration of this symmetry forced by non-Majorana property is in question.

### Is the dynamics of $\mathcal{N} = 2$ or $\mathcal{N} = 4$ SYM possible in right-handed neutrino sector?

Could  $\mathcal{N} = 2$  or  $\mathcal{N} = 4$  SYM be a part of quantum TGD? Could TGD be seen a fusion of a degenerate  $\mathcal{N} = 4$  SYM describing the right-handed neutrino sector and string theory like theory describing the contribution of string world sheets carrying other leptonic and quark spinors? Or could one imagine even something simpler?

What is interesting that the net momenta assigned to the right handed neutrinos associated with a pair of MEs would correspond to the momenta assignable to the particles and obtained by p-adic mass calculations. It would seem that right-handed neutrinos provide a representation of the momenta of the elementary particles represented by wormhole contact structures. Does this mimicry generalize to a full duality so that all quantum numbers and even microscopic dynamics of defined by generalized Feynman diagrams (Euclidian space-time regions) would be represented by right-handed neutrinos and MEs? Could a generalization of  $\mathcal{N} = 4$  SYM with non-trivial gauge group with proper choices of the ground states helicities allow to represent the entire microscopic dynamics?

Irrespective of the answer to this question one can compare the TGD based view about supersymmetric dynamics with what I have understood about  $\mathcal{N} = 4$  SYM.

- In the scattering of MEs induced by the dynamics of Kähler action the right-handed neutrinos play a passive role. Modified Dirac equation forces them to adopt the same direction of four-momentum as the MEs so that the scattering reduces to the geometric scattering for MEs as one indeed expects on basis of quantum classical correspondence. In  $\nu_R$  sector the basic scattering vertex involves four MEs and could be a re-sharing of the right-handed neutrino content of the incoming two MEs between outgoing two MEs respecting fermion number conservation. Therefore  $\mathcal{N} = 4$  SYM with fermion number conservation would represent the scattering of MEs at quantum level.
- $\mathcal{N} = 4$  SUSY would suggest that also in the degenerate case one obtains the full scattering amplitude as a sum of permutations of external particles followed by projections to the directions of light-like momenta and that BCFW bridge represents the analog of fundamental braiding operation. The decoration of permutations means that each external line is effectively doubled. Could the scattering of MEs can be interpreted in terms of these decorated permutations? Could the doubling of permutations by decoration relate to the occurrence of pairs of MEs?

One can also revert these questions. Could one construct massive states in  $\mathcal{N} = 4$  SYM using pairs of momenta associated with particle with integer label  $k$  and its decorated copy with label  $k + n$ ? Massive external particles obtained in this manner as bound states of massless ones could solve the IR divergence problem of  $\mathcal{N} = 4$  SYM.

- The description of amplitudes in terms of leading singularities means picking up of the singular contribution by putting the fermionic propagators on mass shell. In the recent case it would give the inverse of massless Dirac propagator acting on the spinor at the end of the internal line annihilating it if it is a solution of Dirac equation.

The only way out is a kind of cohomology theory in which solutions of Dirac equation represent exact forms. Dirac operator defines the exterior derivative  $d$  and virtual lines correspond to

non-physical helicities with  $d\Psi \neq 0$ . Virtual fermions would be on mass-shell fermions with non-physical polarization satisfying  $d^2\Psi = 0$ . External particles would be those with physical polarization satisfying  $d\Psi = 0$ , and one can say that the Feynman diagrams containing physical helicities split into products of Feynman diagrams containing only non-physical helicities in internal lines.

4. The fermionic states at wormhole contacts should define the ground states of SUSY representation with helicity  $+1/2$  and  $-1/2$  rather than spin 1 or -1 as in standard realization of  $\mathcal{N} = 4$  SYM used in the article. This would modify the theory but the twistorial and Grassmannian description would remain more or less as such since it depends on light-likeness and momentum conservation only.

### 3-vertices for sparticles are replaced with 4-vertices for MEs

In  $\mathcal{N} = 4$  SYM the basic vertex is on mass-shell 3-vertex which requires that for real light-like momenta all 3 states are parallel. One must allow complex momenta in order to satisfy energy conservation and light-likeness conditions. This is strange from the point of view of physics although number theoretically oriented person might argue that the extensions of rationals involving also imaginary unit are rather natural.

The complex momenta can be expressed in terms of two light-like momenta in 3-vertex with one real momentum. For instance, the three light-like momenta can be taken to be  $p, k$ , and  $p - ka$  with  $k = ap_R$ . Here  $p$  (incoming momentum) and  $p_R$  are real light-like momenta satisfying  $p \cdot p_R = 0$  but with opposite sign of energy, and  $a$  is complex number. What is remarkable that also the negative sign of energy is necessary also now.

In zero energy ontology the situation is different due to the presence of a pair of MEs, the allowance of negative energies in internal lines, and the fact that scattering of sparticles is induced by that of MEs. In the simplest vertex a massive external particle with non-parallel MEs carrying non-parallel light-like momenta can decay to a pair of MEs with light-like momenta. This can be interpreted as 4-ME-vertex rather than 3-vertex (say) BFF so that complex momenta are not needed. For an incoming boson identified as wormhole contact the vertex can be seen as BFF vertex.

To obtain space-like momentum exchanges one must allow negative sign of energy and one has strong conditions coming from momentum conservation and light-likeness which allow non-trivial solutions since the basically 4-vertices are in question. This reduces dramatically the number of graphs. Note that one can also consider vertices in which three pairs of MEs join along their ends so that 6 MEs (analog of 3-boson vertex) would be involved.

### Is SUSY breaking possible or needed?

It is difficult to imagine the breaking of the proposed kind of SUSY in TGD framework, and the first guess is that all these 4 super-partners of particle have identical masses. p-Adic thermodynamics does not distinguish between these states and the only possibility is that the p-adic primes differ for the spartners. But is the breaking of SUSY really necessary? Can one really distinguish between the 8 different states of a given elementary particle using the recent day experimental methods?

1. In electroweak and color interactions the spartners behave in an identical manner classically. The coupling of right-handed neutrinos to space-time geometry however forces the right-handed neutrinos to adopt the same direction of four-momentum as MEs has. Could some gravitational effect allow to distinguish between spartners? This would be trivially the case if the p-adic mass scales of spartners would be different. Why this should be the case remains however an open question.
2. In the case of unbroken SUSY only spin distinguishes between spartners. Spin determines statistics and the first naive guess would be that bosonic spartners obey totally different atomic physics allowing condensation of selectrons to the ground state. Very probably this is not true: the right-handed neutrinos are delocalized to 4-D MEs and other fermions correspond to wormhole contact structures and 2-D string world sheets.

The coupling of the spin to the space-time geometry seems to provide the only possible manner to distinguish between spartners. Could one imagine a gravimagnetic effect with energy splitting

proportional to the product of gravimagnetic moment and external gravimagnetic field  $B$ ? If gravimagnetic moment is proportional to spin projection in the direction of  $B$ , a non-trivial effect would be possible. Needless to say this kind of effect is extremely small so that the unbroken SUSY might remain undetected.

3. If the spin of sparticle be seen in the classical angular momentum of ME as quantum classical correspondence would suggest then the value of the angular momentum might allow to distinguish between spartners. Also now the effect is extremely small.



# Mathematics

- [A1] Gaussian Mersenne. <http://primes.utm.edu/glossary/xpage/GaussianMersenne.html>.
- [A2] Z. I. Borevich and I. R. Shafarevich. *Number Theory*. Academic Press, 1966.
- [A3] Eisenhart. *Riemannian Geometry*. Princeton University Press, 1964.
- [A4] C. N. Pope G. W. Gibbons.  $CP_2$  as gravitational instanton. *Comm. Math. Phys.*, 55, 1977.
- [A5] W. Hawking, S. and N. Pope, C. Generalized Spin Structures in Quantum Gravity. *Phys. Lett.*, (1), 1978.
- [A6] S. Helgason. *Differential Geometry and Symmetric Spaces*. Academic Press, New York, 1962.
- [A7] C. Itzykson and J-B. Zuber. *Quantum Field Theory*, volume 549. Mc Graw-Hill, New York, 1980.
- [A8] J. Milnor. *Topology form Differential Point of View*. The University Press of Virginia, Virginia, 1965.
- [A9] D. S. Moak. The q-analogue of the Laguerre polynomials. *J. Math. Anal. Appl.*, 81, 1981.
- [A10] N. Pope, C. Eigenfunctions and  $Spin^c$  Structures on  $CP_2$ , 1980.
- [A11] B. Shipman. The geometry of momentum mappings on generalized flag manifolds, connections with a dynamical system, quantum mechanics and the dance of honeybee. <http://math.cornell.edu/~oliver/Shipman.gif>, 1998.
- [A12] M. Spivak. *Differential Geometry I,II,III,IV*. Publish or Perish, Boston, 1970.
- [A13] J. Hanson T. Eguchi, B. Gilkey. *Phys. Rep.*, 66:1980, 1980.
- [A14] R. Thom. *Commentarii Math. Helvet.*, 28, 1954.
- [A15] Wallace. *Differential Topology*. W. A. Benjamin, New York, 1968.
- [A16] E. C. Zeeman. *Catastrophe Theory*. Addison-Wessley Publishing Company, 1977.





# Theoretical Physics

- [B1] J. Björken and S. Drell. *Relativistic Quantum Fields*. Mc Graw-Hill, New York, 1965.
- [B2] K. Huang. *Quarks, Leptons & Gauge Fields*. World Scientific, 1982.
- [B3] R. Kiehn. Electromagnetic waves in vacuum with torsion and spin. <http://www22.pair.com/csdc/pdf/helical6.pdf>.
- [B4] G. Parisi. *Field Theory, Disorder and Simulations*. World Scientific, 1992.
- [B5] A. Zee. *The Unity of Forces in the Universe*. World Science Press, Singapore, 1982.



# Particle and Nuclear Physics

- [C1] Giant Dipole Resonance: What is Known About? <http://cdfc.sinp.msu.ru/publications/lshkhv-ELI03.pdf>.
- [C2] Abragam A. *The principles of nuclear magnetism*. Clarendon Press, Oxford, 1961.
- [C3] C. Rolfs et al. First hints on a change of the  $^{22}\text{Na}$  beta decay half-life in the metal Pd. *Eur. Phys. J. A*, 28, 2006.
- [C4] C. Rolfs et al. High-Z electron screening, the cases  $^{50}\text{V}(p,n)^{50}$ . *Eur. Phys. J. A*, 28, 2006.
- [C5] G. Tertuchny et al. Microscopic description of the pygmy and giant electric dipole resonances in stable Ca isotopes. <http://arxiv.org/abs/nucl-th/0603/0603051>, 2006.
- [C6] S. E. Shnoll et al. Realization of discrete states during fluctuations in macroscopic processes. *Uspekhi Fisicheskikh Nauk*, 41(10):1025–1035, 1998.
- [C7] V. M. Lobashev et al. In *Neutrino 96*, Singapore, 1996. World Scientific.
- [C8] K. Langanke H. J. Assenbaum and C. Rolfs. *Z. Phys. A*, 327, 1987.
- [C9] A. D. Krisch. The spin of proton. *Scientific American*, May 1979.
- [C10] M. T. Ressel and M. S. Turner. *Astrophys.*, 14, 1990.
- [C11] C. Rolfs and W. S. Rodney. *Cauldrons in the Cosmos*. University of Chicago Press, Chicago, 1988.



# Books related to TGD

- [K1] M. Pitkänen. 1983.
- [K2] M. Pitkänen. Is it Possible to Understand Coupling Constant Evolution at Space-Time Level? In *Towards M-Matrix*. Onlinebook. [http://tgdtheory.com/public\\_html/tgdquant/tgdquant.html#rgflow](http://tgdtheory.com/public_html/tgdquant/tgdquant.html#rgflow), 2006.
- [K3] M. Pitkänen. About Strange Effects Related to Rotating Magnetic Systems . In *TGD and Fringe Physics*. Onlinebook. [http://tgdtheory.com/public\\_html/freenergy/freenergy.html#Faraday](http://tgdtheory.com/public_html/freenergy/freenergy.html#Faraday), 2006.
- [K4] M. Pitkänen. About the New Physics Behind Qualia. In *Quantum Hardware of Living Matter*. Onlinebook. [http://tgdtheory.com/public\\_html/bioware/bioware.html#newphys](http://tgdtheory.com/public_html/bioware/bioware.html#newphys), 2006.
- [K5] M. Pitkänen. An Overview about Quantum TGD: Part I. In *Topological Geometrodynamics: Overview*. Onlinebook. [http://tgdtheory.com/public\\_html/tgdview/tgdview.html#evoII](http://tgdtheory.com/public_html/tgdview/tgdview.html#evoII), 2006.
- [K6] M. Pitkänen. An Overview about the Evolution of Quantum TGD. In *Topological Geometrodynamics: Overview*. Onlinebook. [http://tgdtheory.com/public\\_html/tgdview/tgdview.html#evoI](http://tgdtheory.com/public_html/tgdview/tgdview.html#evoI), 2006.
- [K7] M. Pitkänen. Anomalies Related to the Classical  $Z^0$  Force and Gravitation. In *TGD and Fringe Physics*. Onlinebook. [http://tgdtheory.com/public\\_html/freenergy/freenergy.html#Zanom](http://tgdtheory.com/public_html/freenergy/freenergy.html#Zanom), 2006.
- [K8] M. Pitkänen. Appendix A: Quantum Groups and Related Structures. In *Towards M-Matrix*. Onlinebook. [http://tgdtheory.com/public\\_html/tgdquant/tgdquant.html#bialgebra](http://tgdtheory.com/public_html/tgdquant/tgdquant.html#bialgebra), 2006.
- [K9] M. Pitkänen. Basic Extremals of Kähler Action. In *Physics in Many-Sheeted Space-Time*. Onlinebook. [http://tgdtheory.com/public\\_html/tgdclass/tgdclass.html#class](http://tgdtheory.com/public_html/tgdclass/tgdclass.html#class), 2006.
- [K10] M. Pitkänen. *Bio-Systems as Conscious Holograms*. Onlinebook. [http://tgdtheory.com/public\\_html/hologram/hologram.html](http://tgdtheory.com/public_html/hologram/hologram.html), 2006.
- [K11] M. Pitkänen. Bio-Systems as Conscious Holograms. In *Bio-Systems as Conscious Holograms*. Onlinebook. [http://tgdtheory.com/public\\_html/hologram/hologram.html#hologram](http://tgdtheory.com/public_html/hologram/hologram.html#hologram), 2006.
- [K12] M. Pitkänen. *Bio-Systems as Self-Organizing Quantum Systems*. Onlinebook. [http://tgdtheory.com/public\\_html/bioselforg/bioselforg.html](http://tgdtheory.com/public_html/bioselforg/bioselforg.html), 2006.
- [K13] M. Pitkänen. Bio-Systems as Super-Conductors: part I. In *Quantum Hardware of Living Matter*. Onlinebook. [http://tgdtheory.com/public\\_html/bioware/bioware.html#superc1](http://tgdtheory.com/public_html/bioware/bioware.html#superc1), 2006.
- [K14] M. Pitkänen. Bio-Systems as Super-Conductors: part II. In *Quantum Hardware of Living Matter*. Onlinebook. [http://tgdtheory.com/public\\_html/bioware/bioware.html#superc2](http://tgdtheory.com/public_html/bioware/bioware.html#superc2), 2006.
- [K15] M. Pitkänen. Configuration Space Spinor Structure. In *Quantum Physics as Infinite-Dimensional Geometry*. Onlinebook. [http://tgdtheory.com/public\\_html/tgdgeom/tgdgeom.html#cspin](http://tgdtheory.com/public_html/tgdgeom/tgdgeom.html#cspin), 2006.

- [K16] M. Pitkänen. Construction of elementary particle vacuum functionals. In *p-Adic Length Scale Hypothesis and Dark Matter Hierarchy*. Onlinebook. [http://tgdtheory.com/public\\_html/paddark/paddark.html#elvafu](http://tgdtheory.com/public_html/paddark/paddark.html#elvafu), 2006.
- [K17] M. Pitkänen. Construction of Quantum Theory: M-matrix. In *Towards M-Matrix*. Onlinebook. [http://tgdtheory.com/public\\_html/tgdquant/tgdquant.html#towards](http://tgdtheory.com/public_html/tgdquant/tgdquant.html#towards), 2006.
- [K18] M. Pitkänen. Cosmic Strings. In *Physics in Many-Sheeted Space-Time*. Onlinebook. [http://tgdtheory.com/public\\_html/tgdclass/tgdclass.html#cstrings](http://tgdtheory.com/public_html/tgdclass/tgdclass.html#cstrings), 2006.
- [K19] M. Pitkänen. Crop Circles and Life at Parallel Space-Time Sheets. In *Magnetospheric Consciousness*. Onlinebook. [http://tgdtheory.com/public\\_html/magnconsc/magnconsc.html#crop1](http://tgdtheory.com/public_html/magnconsc/magnconsc.html#crop1), 2006.
- [K20] M. Pitkänen. Crop Circles and Life at Parallel Space-Time Sheets. In *Magnetospheric Consciousness*. Onlinebook. [http://tgdtheory.com/public\\_html/magnconsc/magnconsc.html#crop2](http://tgdtheory.com/public_html/magnconsc/magnconsc.html#crop2), 2006.
- [K21] M. Pitkänen. Dark Forces and Living Matter. In *p-Adic Length Scale Hypothesis and Dark Matter Hierarchy*. Onlinebook. [http://tgdtheory.com/public\\_html/paddark/paddark.html#darkforces](http://tgdtheory.com/public_html/paddark/paddark.html#darkforces), 2006.
- [K22] M. Pitkänen. Dark Matter Hierarchy and Hierarchy of EEGs. In *TGD and EEG*. Onlinebook. [http://tgdtheory.com/public\\_html/tgdeeg/tgdeeg.html#eegdark](http://tgdtheory.com/public_html/tgdeeg/tgdeeg.html#eegdark), 2006.
- [K23] M. Pitkänen. Dark Nuclear Physics and Condensed Matter. In *p-Adic Length Scale Hypothesis and Dark Matter Hierarchy*. Onlinebook. [http://tgdtheory.com/public\\_html/paddark/paddark.html#exonuclear](http://tgdtheory.com/public_html/paddark/paddark.html#exonuclear), 2006.
- [K24] M. Pitkänen. DNA as Topological Quantum Computer. In *Genes and Memes*. Onlinebook. [http://tgdtheory.com/public\\_html/genememe/genememe.html#dnatqc](http://tgdtheory.com/public_html/genememe/genememe.html#dnatqc), 2006.
- [K25] M. Pitkänen. Does TGD Predict the Spectrum of Planck Constants? In *Towards M-Matrix*. Onlinebook. [http://tgdtheory.com/public\\_html/tgdquant/tgdquant.html#Planck](http://tgdtheory.com/public_html/tgdquant/tgdquant.html#Planck), 2006.
- [K26] M. Pitkänen. Evolution in Many-Sheeted Space-Time. In *Genes and Memes*. Onlinebook. [http://tgdtheory.com/public\\_html/genememe/genememe.html#prebio](http://tgdtheory.com/public_html/genememe/genememe.html#prebio), 2006.
- [K27] M. Pitkänen. General Ideas about Many-Sheeted Space-Time: Part I. In *Physics in Many-Sheeted Space-Time*. Onlinebook. [http://tgdtheory.com/public\\_html/tgdclass/tgdclass.html#topcond](http://tgdtheory.com/public_html/tgdclass/tgdclass.html#topcond), 2006.
- [K28] M. Pitkänen. General Theory of Qualia. In *Bio-Systems as Conscious Holograms*. Onlinebook. [http://tgdtheory.com/public\\_html/hologram/hologram.html#qualia](http://tgdtheory.com/public_html/hologram/hologram.html#qualia), 2006.
- [K29] M. Pitkänen. *Genes and Memes*. Onlinebook. [http://tgdtheory.com/public\\_html/genememe/genememe.html](http://tgdtheory.com/public_html/genememe/genememe.html), 2006.
- [K30] M. Pitkänen. Genes and Memes. In *Genes and Memes*. Onlinebook. [http://tgdtheory.com/public\\_html/genememe/genememe.html#genememec](http://tgdtheory.com/public_html/genememe/genememe.html#genememec), 2006.
- [K31] M. Pitkänen. Homeopathy in Many-Sheeted Space-Time. In *Bio-Systems as Conscious Holograms*. Onlinebook. [http://tgdtheory.com/public\\_html/hologram/hologram.html#homeoc](http://tgdtheory.com/public_html/hologram/hologram.html#homeoc), 2006.
- [K32] M. Pitkänen. Macro-Temporal Quantum Coherence and Spin Glass Degeneracy. In *Bio-Systems as Conscious Holograms*. Onlinebook. [http://tgdtheory.com/public\\_html/hologram/hologram.html#macro](http://tgdtheory.com/public_html/hologram/hologram.html#macro), 2006.
- [K33] M. Pitkänen. Macroscopic Quantum Coherence and Quantum Metabolism as Different Sides of the Same Coin. In *Bio-Systems as Conscious Holograms*. Onlinebook. [http://tgdtheory.com/public\\_html/hologram/hologram.html#metab](http://tgdtheory.com/public_html/hologram/hologram.html#metab), 2006.

- [K34] M. Pitkänen. Macroscopic Quantum Phenomena and  $CP_2$  Geometry. In *Physics in Many-Sheeted Space-Time*. Onlinebook. [http://tgdtheory.com/public\\_html/tgdclass/tgdclass.html#super](http://tgdtheory.com/public_html/tgdclass/tgdclass.html#super), 2006.
- [K35] M. Pitkänen. Magnetic Sensory Canvas Hypothesis. In *TGD and EEG*. Onlinebook. [http://tgdtheory.com/public\\_html//tgdeeg/tgdeeg/tgdeeg.html#mec](http://tgdtheory.com/public_html//tgdeeg/tgdeeg/tgdeeg.html#mec), 2006.
- [K36] M. Pitkänen. *Magnetospheric Consciousness*. Onlinebook. [http://tgdtheory.com/public\\_html/magnconsc/magnconsc.html](http://tgdtheory.com/public_html/magnconsc/magnconsc.html), 2006.
- [K37] M. Pitkänen. Magnetospheric Sensory Representations. In *Magnetospheric Consciousness*. Onlinebook. [http://tgdtheory.com/public\\_html/magnconsc/magnconsc.html#srepre](http://tgdtheory.com/public_html/magnconsc/magnconsc.html#srepre), 2006.
- [K38] M. Pitkänen. Many-Sheeted DNA. In *Genes and Memes*. Onlinebook. [http://tgdtheory.com/public\\_html/genememe/genememe.html#genecodec](http://tgdtheory.com/public_html/genememe/genememe.html#genecodec), 2006.
- [K39] M. Pitkänen. Massless states and particle massivation. In *p-Adic Length Scale Hypothesis and Dark Matter Hierarchy*. Onlinebook. [http://tgdtheory.com/public\\_html/paddark/paddark.html#mless](http://tgdtheory.com/public_html/paddark/paddark.html#mless), 2006.
- [K40] M. Pitkänen. *Mathematical Aspects of Consciousness Theory*. Onlinebook. [http://tgdtheory.com/public\\_html/mathconsc/mathconsc.html](http://tgdtheory.com/public_html/mathconsc/mathconsc.html), 2006.
- [K41] M. Pitkänen. Matter, Mind, Quantum. In *TGD Inspired Theory of Consciousness*. Onlinebook. [http://tgdtheory.com/public\\_html/tgdconsc/tgdconsc.html#conscic](http://tgdtheory.com/public_html/tgdconsc/tgdconsc.html#conscic), 2006.
- [K42] M. Pitkänen. Negentropy Maximization Principle. In *TGD Inspired Theory of Consciousness*. Onlinebook. [http://tgdtheory.com/public\\_html/tgdconsc/tgdconsc.html#nmpc](http://tgdtheory.com/public_html/tgdconsc/tgdconsc.html#nmpc), 2006.
- [K43] M. Pitkänen. New Particle Physics Predicted by TGD: Part I. In *p-Adic Length Scale Hypothesis and Dark Matter Hierarchy*. Onlinebook. [http://tgdtheory.com/public\\_html/paddark/paddark.html#mass4](http://tgdtheory.com/public_html/paddark/paddark.html#mass4), 2006.
- [K44] M. Pitkänen. Nuclear String Hypothesis. In *p-Adic Length Scale Hypothesis and Dark Matter Hierarchy*. Onlinebook. [http://tgdtheory.com/public\\_html/paddark/paddark.html#nuclstring](http://tgdtheory.com/public_html/paddark/paddark.html#nuclstring), 2006.
- [K45] M. Pitkänen. *p-Adic length Scale Hypothesis and Dark Matter Hierarchy*. Onlinebook. [http://tgdtheory.com/public\\_html/paddark/paddark.html](http://tgdtheory.com/public_html/paddark/paddark.html), 2006.
- [K46] M. Pitkänen. p-Adic Particle Massivation: Hadron Masses. In *p-Adic Length Scale Hypothesis and Dark Matter Hierarchy*. Onlinebook. [http://tgdtheory.com/public\\_html/paddark/paddark.html#mass3](http://tgdtheory.com/public_html/paddark/paddark.html#mass3), 2006.
- [K47] M. Pitkänen. p-Adic Physics as Physics of Cognition and Intention. In *TGD Inspired Theory of Consciousness*. Onlinebook. [http://tgdtheory.com/public\\_html/tgdconsc/tgdconsc.html#cognic](http://tgdtheory.com/public_html/tgdconsc/tgdconsc.html#cognic), 2006.
- [K48] M. Pitkänen. *Physics in Many-Sheeted Space-Time*. Onlinebook. [http://tgdtheory.com/public\\_html/tgdclass/tgdclass.html](http://tgdtheory.com/public_html/tgdclass/tgdclass.html), 2006.
- [K49] M. Pitkänen. Quantum Antenna Hypothesis. In *Quantum Hardware of Living Matter*. Onlinebook. [http://tgdtheory.com/public\\_html/bioware/bioware.html#tubuc](http://tgdtheory.com/public_html/bioware/bioware.html#tubuc), 2006.
- [K50] M. Pitkänen. Quantum Astrophysics. In *Physics in Many-Sheeted Space-Time*. Onlinebook. [http://tgdtheory.com/public\\_html/tgdclass/tgdclass.html#qastro](http://tgdtheory.com/public_html/tgdclass/tgdclass.html#qastro), 2006.
- [K51] M. Pitkänen. Quantum Control and Coordination in Bio-systems: Part I. In *Bio-Systems as Self-Organizing Quantum Systems*. Onlinebook. [http://tgdtheory.com/public\\_html/bioselforg/bioselforg.html#qcococI](http://tgdtheory.com/public_html/bioselforg/bioselforg.html#qcococI), 2006.
- [K52] M. Pitkänen. Quantum Control and Coordination in Bio-Systems: Part II. In *Bio-Systems as Self-Organizing Quantum Systems*. Onlinebook. [http://tgdtheory.com/public\\_html/bioselforg/bioselforg.html#qcococII](http://tgdtheory.com/public_html/bioselforg/bioselforg.html#qcococII), 2006.

- [K53] M. Pitkänen. *Quantum Hardware of Living Matter*. Onlinebook. [http://tgdtheory.com/public\\_html/bioware/bioware.html](http://tgdtheory.com/public_html/bioware/bioware.html), 2006.
- [K54] M. Pitkänen. Quantum Model for Hearing. In *TGD and EEG*. Onlinebook. [http://tgdtheory.com/public\\_html//tgdeeg/tgdeeg/tgdeeg.html#hearing](http://tgdtheory.com/public_html//tgdeeg/tgdeeg/tgdeeg.html#hearing), 2006.
- [K55] M. Pitkänen. Quantum Model for Nerve Pulse. In *TGD and EEG*. Onlinebook. [http://tgdtheory.com/public\\_html//tgdeeg/tgdeeg/tgdeeg.html#pulse](http://tgdtheory.com/public_html//tgdeeg/tgdeeg/tgdeeg.html#pulse), 2006.
- [K56] M. Pitkänen. Quantum Model for Paranormal Phenomena. In *TGD Inspired Theory of Consciousness*. Onlinebook. [http://tgdtheory.com/public\\_html/tgdconsc/tgdconsc.html#parac](http://tgdtheory.com/public_html/tgdconsc/tgdconsc.html#parac), 2006.
- [K57] M. Pitkänen. Quantum Model for Sensory Representations. In *TGD Inspired Theory of Consciousness*. Onlinebook. [http://tgdtheory.com/public\\_html/tgdconsc/tgdconsc.html#expc](http://tgdtheory.com/public_html/tgdconsc/tgdconsc.html#expc), 2006.
- [K58] M. Pitkänen. Quantum Model of EEG. In *TGD and EEG*. Onlinebook. [http://tgdtheory.com/public\\_html/tgdeeg/tgdeeg.html#eegII](http://tgdtheory.com/public_html/tgdeeg/tgdeeg.html#eegII), 2006.
- [K59] M. Pitkänen. Quantum Model of Memory. In *TGD Inspired Theory of Consciousness*. Onlinebook. [http://tgdtheory.com/public\\_html/tgdconsc/tgdconsc.html#memoryc](http://tgdtheory.com/public_html/tgdconsc/tgdconsc.html#memoryc), 2006.
- [K60] M. Pitkänen. *Quantum Physics as Infinite-Dimensional Geometry*. Onlinebook. [http://tgdtheory.com/public\\_html/tgdgeom/tgdgeom.html](http://tgdtheory.com/public_html/tgdgeom/tgdgeom.html), 2006.
- [K61] M. Pitkänen. *Quantum TGD*. Onlinebook. [http://tgdtheory.com/public\\_html/tgdquant/tgdquant.html](http://tgdtheory.com/public_html/tgdquant/tgdquant.html), 2006.
- [K62] M. Pitkänen. Quantum Theory of Self-Organization. In *Bio-Systems as Self-Organizing Quantum Systems*. Onlinebook. [http://tgdtheory.com/public\\_html/bioselforg/bioselforg.html#selforgac](http://tgdtheory.com/public_html/bioselforg/bioselforg.html#selforgac), 2006.
- [K63] M. Pitkänen. Semi-trance, Mental Illness, and Altered States of Consciousness. In *Magnetospheric Consciousness*. Onlinebook. [http://tgdtheory.com/public\\_html/magnconsc/magnconsc.html#semitrancec](http://tgdtheory.com/public_html/magnconsc/magnconsc.html#semitrancec), 2006.
- [K64] M. Pitkänen. Semitrance, Language, and Development of Civilization. In *Magnetospheric Consciousness*. Onlinebook. [http://tgdtheory.com/public\\_html/magnconsc/magnconsc.html#langsoc](http://tgdtheory.com/public_html/magnconsc/magnconsc.html#langsoc), 2006.
- [K65] M. Pitkänen. TGD and Astrophysics. In *Physics in Many-Sheeted Space-Time*. Onlinebook. [http://tgdtheory.com/public\\_html/tgdclass/tgdclass.html#astro](http://tgdtheory.com/public_html/tgdclass/tgdclass.html#astro), 2006.
- [K66] M. Pitkänen. TGD and Cosmology. In *Physics in Many-Sheeted Space-Time*. Onlinebook. [http://tgdtheory.com/public\\_html/tgdclass/tgdclass.html#cosmo](http://tgdtheory.com/public_html/tgdclass/tgdclass.html#cosmo), 2006.
- [K67] M. Pitkänen. *TGD and EEG*. Onlinebook. [http://tgdtheory.com/public\\_html/tgdeeg/tgdeeg.html](http://tgdtheory.com/public_html/tgdeeg/tgdeeg.html), 2006.
- [K68] M. Pitkänen. *TGD and Fringe Physics*. Onlinebook. [http://tgdtheory.com/public\\_html/freenergy/freenergy.html](http://tgdtheory.com/public_html/freenergy/freenergy.html), 2006.
- [K69] M. Pitkänen. TGD and Nuclear Physics. In *p-Adic Length Scale Hypothesis and Dark Matter Hierarchy*. Onlinebook. [http://tgdtheory.com/public\\_html/paddark/paddark.html#padnucl](http://tgdtheory.com/public_html/paddark/paddark.html#padnucl), 2006.
- [K70] M. Pitkänen. *TGD as a Generalized Number Theory*. Onlinebook. [http://tgdtheory.com/public\\_html/tgdnumber/tgdnumber.html](http://tgdtheory.com/public_html/tgdnumber/tgdnumber.html), 2006.
- [K71] M. Pitkänen. TGD as a Generalized Number Theory: p-Adicization Program. In *TGD as a Generalized Number Theory*. Onlinebook. [http://tgdtheory.com/public\\_html/tgdnumber/tgdnumber.html#visiona](http://tgdtheory.com/public_html/tgdnumber/tgdnumber.html#visiona), 2006.



- [K72] M. Pitkänen. TGD as a Generalized Number Theory: Quaternions, Octonions, and their Hyper Counterparts. In *TGD as a Generalized Number Theory*. Onlinebook. [http://tgdtheory.com/public\\_html/tgdnumber/tgdnumber.html#visionb](http://tgdtheory.com/public_html/tgdnumber/tgdnumber.html#visionb), 2006.
- [K73] M. Pitkänen. TGD Based Model for OBEs. In *TGD Inspired Theory of Consciousness*. Onlinebook. [http://tgdtheory.com/public\\_html/tgdconsc/tgdconsc.html#OBE](http://tgdtheory.com/public_html/tgdconsc/tgdconsc.html#OBE), 2006.
- [K74] M. Pitkänen. *TGD Inspired Theory of Consciousness*. Onlinebook. [http://tgdtheory.com/public\\_html/tgdconsc/tgdconsc.html](http://tgdtheory.com/public_html/tgdconsc/tgdconsc.html), 2006.
- [K75] M. Pitkänen. TGD Inspired Theory of Consciousness. In *Topological Geometrodynamics: Overview*. Onlinebook. [http://tgdtheory.com/public\\_html/tgdview/tgdview.html#tgdconsc2010](http://tgdtheory.com/public_html/tgdview/tgdview.html#tgdconsc2010), 2006.
- [K76] M. Pitkänen. The Notion of Free Energy and Many-Sheeted Space-Time Concept. In *TGD and Fringe Physics*. Onlinebook. [http://tgdtheory.com/public\\_html/freenergy/freenergy.html#freenergy](http://tgdtheory.com/public_html/freenergy/freenergy.html#freenergy), 2006.
- [K77] M. Pitkänen. The Relationship Between TGD and GRT. In *Physics in Many-Sheeted Space-Time*. Onlinebook. [http://tgdtheory.com/public\\_html/tgdclass/tgdclass.html#tgdgrt](http://tgdtheory.com/public_html/tgdclass/tgdclass.html#tgdgrt), 2006.
- [K78] M. Pitkänen. Three new physics realizations of the genetic code and the role of dark matter in bio-systems. In *Genes and Memes*. Onlinebook. [http://tgdtheory.com/public\\_html/genememe/genememe.html#dnatqccodes](http://tgdtheory.com/public_html/genememe/genememe.html#dnatqccodes), 2006.
- [K79] M. Pitkänen. Time, Spacetime and Consciousness. In *Bio-Systems as Conscious Holograms*. Onlinebook. [http://tgdtheory.com/public\\_html/hologram/hologram.html#time](http://tgdtheory.com/public_html/hologram/hologram.html#time), 2006.
- [K80] M. Pitkänen. *Topological Geometrodynamics: an Overview*. Onlinebook. [http://tgdtheory.com/public\\_html/tgdview/tgdview.html](http://tgdtheory.com/public_html/tgdview/tgdview.html), 2006.
- [K81] M. Pitkänen. Topological Quantum Computation in TGD Universe. In *Genes and Memes*. Onlinebook. [http://tgdtheory.com/public\\_html/genememe/genememe.html#tqc](http://tgdtheory.com/public_html/genememe/genememe.html#tqc), 2006.
- [K82] M. Pitkänen. Was von Neumann Right After All. In *Towards M-Matrix*. Onlinebook. [http://tgdtheory.com/public\\_html/tgdquant/tgdquant.html#vNeumann](http://tgdtheory.com/public_html/tgdquant/tgdquant.html#vNeumann), 2006.
- [K83] M. Pitkänen. Wormhole Magnetic Fields. In *Quantum Hardware of Living Matter*. Onlinebook. [http://tgdtheory.com/public\\_html/bioware/bioware.html#wormc](http://tgdtheory.com/public_html/bioware/bioware.html#wormc), 2006.



# Articles about TGD

- [L1] M. Pitkänen. Macro-temporal quantum coherence, quantum spin glass degeneracy, and number theoretic information concept. <http://www.emergentmind.org/journal.htm>, 2003.
- [L2] M. Pitkänen. Time, Space-Time, and Consciousness. <http://www.emergentmind.org/journal.htm>, 2003.
- [L3] M. Pitkänen. Further Progress in Nuclear String Hypothesis. <http://tgdtheory.com/articles/nuclstring.pdf>, 2007.
- [L4] M. Pitkänen. TGD based solution of Fermi paradox. <http://www.physics.helsinki.fi/~matpitka/articles/fermieng.pdf>, 2007.



## Chapter 12

# Generalized Feynman Graphs as Generalized Braids

### 12.1 Introduction

Ulla send me a link to an article by Sam Nelson about very interesting new-to-me notion known as algebraic knots [?, ?], which has initiated a revolution in knot theory. This notion was introduced 1996 by Louis Kauffman [?] so that it is already 15 year old concept. While reading the article I realized that this notion fits perfectly the needs of TGD and leads to a progress in attempts to articulate more precisely what generalized Feynman diagrams are. It should be added that the knots and braids are not anything new in TGD framework and I have considered knot theory from TGD point of view already earlier [?].

The basic challenge of quantum TGD is to give a precise content to the notion of generalization Feynman diagram and the reduction to braids of some kind is very attractive possibility inspired by zero energy ontology. The point is that no  $n > 2$ -vertices at the level of braid strands are needed if bosonic emergence holds true. In the following I will summarize briefly the vision about generalized Feynman diagrams, introduce the notion of algebraic knot, and after than discuss in more detail how the notion of algebraic knot could be applied to generalized Feynman diagrams.

1. The algebraic structures kei, quandle, rack, and biquandle and their algebraic modifications as such are not enough. The lines of Feynman graphs are replaced by braids and in vertices braid strands redistribute. This poses several challenges: the crossing associated with braiding and crossing occurring in non-planar Feynman diagrams should be integrated to a more general notion; braids are replaced with sub-manifold braids; braids of braids ....of braids are possible; the redistribution of braid strands in vertices should be algebraized. In the following I try to abstract the basic operations which should be algebraized in the case of generalized Feynman diagrams.
2. One should be also able to concretely identify braids and 2-braids (string world sheets) as well as partonic 2-surfaces and I have discussed several identifications during last years. Legendrian braids turn out to be very natural candidates for braids and their duals for the partonic 2-surfaces. String world sheets in turn could correspond to the analogs of Lagrangian sub-manifolds or to minimal surfaces of space-time surface satisfying the weak form of electric-magnetic duality. The latter option turns out to be more plausible. Finite measurement resolution would be realized as symplectic invariance with respect to the subgroup of the symplectic group leaving the end points of braid strands invariant. In accordance with the general vision TGD as almost topological QFT would mean symplectic QFT. The identification of braids, partonic 2-surfaces and string world sheets - if correct - would solve quantum TGD explicitly at string world sheet level in other words in finite measurement resolution.
3. Irrespective of whether the algebraic knots are needed, the natural question is what generalized Feynman diagrams are. It seems that the basic building bricks can be identified so that one can write rather explicit Feynman rules already now. Of course, the rules are still far from

something to be burned into the spine of the first year graduate student. A brief summary of generalized Feynman rules in zero energy ontology is proposed. This requires the identification of vertices, propagators, and prescription for integrating over all 3-surfaces. It turns out that the basic building blocks of generalized Feynman diagrams are well-defined.

4. The notion of generalized Feynman diagram leads to a beautiful duality between the descriptions of hadronic reactions in terms of hadrons and partons analogous to gauge-gravity duality and AdS/CFT duality but requiring no additional assumptions. The model of quark gluon plasma as a strongly interacting phase is proposed. Color magnetic flux tubes are responsible for the long range correlations making the plasma phase more like a very large hadron rather than a gas of partons. One also ends up with a simple estimate for the viscosity/entropy ratio using black-hole analogy.

## 12.2 Algebraic braids, sub-manifold braid theory, and generalized Feynman diagrams

Ulla send me a link to an article by Sam Nelson about very interesting new-to-me notion known as algebraic knots [?, ?], which has initiated a revolution in knot theory. This notion was introduced 1996 by Louis Kauffman [?] so that it is already 15 year old concept. While reading the article I realized that this notion fits perfectly the needs of TGD and leads to a progress in attempts to articulate more precisely what generalized Feynman diagrams are.

In the following I will summarize briefly the vision about generalized Feynman diagrams, introduce the notion of algebraic knot, and after that discuss in more detail how the notion of algebraic knot could be applied to generalized Feynman diagrams. The algebraic structures *kei*, *quandle*, *rack*, and *biquandle* and their algebraic modifications as such are not enough. The lines of Feynman graphs are replaced by braids and in vertices braid strands redistribute. This poses several challenges: the crossing associated with braiding and crossing occurring in non-planar Feynman diagrams should be integrated to a more general notion; braids are replaced with sub-manifold braids; braids of braids ...of braids are possible; the redistribution of braid strands in vertices should be algebraized. In the following I try to abstract the basic operations which should be algebraized in the case of generalized Feynman diagrams.

One should be also able to concretely identify braids and 2-braids (string world sheets) as well as partonic 2-surfaces and I have discussed several identifications during last years. Legendrian braids turn out to be very natural candidates for braids and their duals for the partonic 2-surfaces. String world sheets in turn could correspond to the analogs of Lagrangian sub-manifolds or to minimal surfaces of space-time surface satisfying the weak form of electric-magnetic duality. The latter option turns out to be more plausible. Finite measurement resolution would be realized as symplectic invariance with respect to the subgroup of the symplectic group leaving the end points of braid strands invariant. In accordance with the general vision TGD as almost topological QFT would mean symplectic QFT. The identification of braids, partonic 2-surfaces and string world sheets - if correct - would solve quantum TGD explicitly at string world sheet level in other words in finite measurement resolution.

Irrespective of whether the algebraic knots are needed, the natural question is what generalized Feynman diagrams are. It seems that the basic building bricks can be identified so that one can write rather explicit Feynman rules already now. Of course, the rules are still far from something to be burned into the spine of the first year graduate student.

### 12.2.1 Generalized Feynman diagrams, Feynman diagrams, and braid diagrams

#### How knots and braids a la TGD differ from standard knots and braids?

TGD approach to knots and braids differs from the knot and braid theories in given abstract 3-manifold (4-manifold in case of 2-knots and 2-braids) is that space-time is in TGD framework identified as 4-D surface in  $M^4 \times CP_2$  and preferred 3-surfaces correspond to light-like 3-surfaces defined by wormhole throats and space-like 3-surfaces defined by the ends of space-time sheets at the two light-like boundaries of causal diamond  $CD$ .

The notion of finite measurement resolution effectively replaces 3-surfaces of both kinds with braids and space-time surface with string world sheets having braids strands as their ends. The 4-dimensionality of space-time implies that string world sheets can be knotted and intersect at discrete points (counterpart of linking for ordinary knots). Also space-time surface can have self-intersections consisting of discrete points.

The ordinary knot theory in  $E^3$  involves projection to a preferred 2-plane  $E^2$  and one assigns to the crossing points of the projection an index distinguishing between two cases which are transformed to each other by violently taking the first piece of strand through another piece of strand. In TGD one must identify some physically preferred 2-dimensional manifold in imbedding space to which the braid strands are projected. There are many possibilities even when one requires maximal symmetries. An obvious requirement is however that this 2-manifold is large enough.

1. For the braids at the ends of space-time surface the 2-manifold could be large enough sphere  $S^2$  of light-cone boundary in coordinates in which the line connecting the tips of  $CD$  defines a preferred time direction and therefore unique light-like radial coordinate. In very small knots it could be also the geodesic sphere of  $CP_2$  (apart from the action of isometries there are two geodesic spheres in  $CP_2$ ).
2. For light-like braids the preferred plane would be naturally  $M^2$  for which time direction corresponds to the line connecting the tips of  $CD$  and spatial direction to the quantization axis of spin. Note that these axes are fixed uniquely and the choices of  $M^2$  are labelled by the points of projective sphere  $P^2$  telling the direction of space-like axis. Preferred plane  $M^2$  emerges naturally also from number theoretic vision and corresponds in octonionic pictures to hyper-complex plane of hyper-octonions. It is also forced by the condition that the choice of quantization axes has a geometric correlate both at the level of imbedding space geometry and the geometry of the "world of classical worlds".

The braid theory in TGD framework could be called sub-manifold braid theory and certainly differs from the standard one.

1. If the first homology group of the 3-surface is non-trivial as it when the light-like 3-surfaces represents an orbit of partonic 2-surface with genus larger than zero, the winding of the braid strand (wrapping of branes in M-theory) meaning that it represents a homologically non-trivial curve brings in new effects not described by the ordinary knot theory. A typical new situation is the one in which 3-surface is locally a product of higher genus 2-surface and line segment so that knot strand can wind around the 2-surface. This gives rise to what are called non-planar braid diagrams for which the projection to plane produces non-standard crossings.
2. In the case of 2-knots similar exotic effects could be due to the non-trivial 2-homology of space-time surface. Wormhole throats assigned with elementary particle wormhole throats are homologically non-trivial 2-surfaces and might make this kind of effects possible for 2-knots if they are possible.

The challenge is to find a generalization of the usual knot and braid theories so that they apply in the case of braids (2-braids) imbedded in 3-D (4-D) surfaces with preferred highly symmetry sub-manifold of  $M^4 \times CP_2$  defining the analog of plane to which the knots are projected. A proper description of exotic crossings due to non-trivial homology of 3-surface (4-surface) is needed.

### Basic questions

The questions are following.

1. How the mathematical framework of standard knot theory should be modified in order to cope with the situation encountered in TGD? To my surprise I found that this kind of mathematical framework exists: so called algebraic knots [?, ?] define a generalization of knot theory very probably able to cope with this kind of situation.
2. Second question is whether the generalized Feynman diagrams could be regarded as braid diagrams in generalized sense. Generalized Feynman diagrams are generalizations of ordinary

Feynman diagrams. The lines of generalized Feynman diagrams correspond to the orbits of wormhole throats and of wormhole contacts with throats carrying elementary particle quantum numbers.

The lines meet at vertices which are partonic 2-surfaces. Single wormhole throat can describe fermion whereas bosons have wormhole contacts with fermion and antifermion at the opposite throats as building bricks. It seems however that all fermions carry Kähler magnetic charge so that physical particles are string like objects with magnetic charges at their ends.

The short range of weak interactions results from the screening of the axial isospin by neutrinos at the other end of string like object and also color confinement could be understood in this manner. One cannot exclude the possibility that the length of magnetic flux tube is of order Compton length.

3. Vertices of the generalized Feynman diagrams correspond to the partonic 2-surfaces along which light-like 3-surfaces meet and this is certainly a challenge for the required generalization of braid theory. The basic objection against the reduction to algebraic braid diagrams is that reaction vertices for particles cannot be described by ordinary braid theory: the splitting of braid strands is needed.

The notion of bosonic emergence [?] however suggests that 3-vertex and possible higher vertices correspond to the splitting of braids rather than braid strands. By allowing braids which come from both past and future and identifying free fermions as wormhole throats and bosons as wormhole contacts consisting of a pair of wormhole throats carrying fermion and antifermion number, one can understand boson exchanges as recombinations without any need to have splitting of braid strands. Strictly and technically speaking, one would have tangles like objects instead of braids. This would be an enormous simplification since  $n > 2$ -vertices which are the source of divergences in QFT:s would be absent.

4. Non-planar Feynman diagrams are the curse of the twistor approach and I have already earlier proposed that the generalized Feynman amplitudes and perhaps even twistorial amplitudes could be constructed as analogs of knot invariants by recursively transforming non-planar Feynman diagrams to planar ones for which one can write twistor amplitudes. This forces to answer two questions.
  - (a) Does the non-nonplanarity of Feynman diagrams - completely combinatorial objects identified as diagrams in plane - have anything to do with the non-planarity of algebraic knot diagrams and with the non-planarity of generalized Feynman diagrams which are purely geometric objects?
  - (b) Could these two kind of non-planarities be fused to together by identifying the projection 2-plane as preferred  $M^2 \subset M^4$ . This would mean that non-planarity in QFT sense is defined for entire braids: braid A can have virtual crossing with B. Non-planarity in the sense of knot theory would be defined for braid strands inside the braids. At vertices braid strands are redistributed between incoming lines and the analog of virtual crossing be identifiable as an exchange of braid strand between braids. Several kinds of non-planarities would be present and the idea about gradual unknotting of a non-planar diagram so that a planar diagram results as the final outcome might make sense and allow to generalize the recursion recipe for the twistorial amplitudes.
  - (c) One might consider the possibility that inside orbits of wormhole throats defining the lines of Feynman diagrams the  $R$ -matrix for integrable QFT in  $M^2$  (only permutations of momenta are allowed) describes the dynamics so that one obtains just a permutation of momenta assigned to the braid strands. Ordinary braiding would be described by existing braid theories. The core problem would be the representation of the exchange of a strand between braids algebraically.

### 12.2.2 Brief summary of algebraic knot theory

#### Basic ideas of algebraic knot theory

In ordinary knot theory one takes as a starting point the representation of knots of  $E^3$  by their plane plane projections to which one attach a "color" to each crossing telling whether the strand goes over



or under the strand it crosses in planar projection. These numbers are fixed uniquely as one traverses through the entire knot in given direction.

The so called Reidemeister moves are the fundamental modifications of knot leaving its isotopy equivalence class unchanged and correspond to continuous deformations of the knot. Any algebraic invariant assignable to the knot must remain unaffected under these moves. Reidemeister moves as such look completely trivial and the non-trivial point is that they represent the minimum number of independent moves which are represented algebraically.

In algebraic knot theory topological knots are replaced by typographical knots resulting as planar projections. This mapping of topology to algebra and this is always fascinating. It turns out that the existing knot invariants generalize and ordinary knot theory can be seen as a special case of the algebraic knot theory. In a loose sense one can say that the algebraic knots are to the classical knot theory what algebraic numbers are to rational numbers.

Virtual crossing is the key notion of the algebraic knot theory. Virtual crossing and their rules of interaction were introduced 1996 by Louis Kauffman as basic notions [?]. For instance, a strand with only virtual crossings should be replaceable by any strand with the same number of virtual crossings and same end points. Reidemeister moves generalize to virtual moves. One can say that in this case crossing is self-intersection rather than going under or above. I cannot be eliminated by a small deformation of the knot. There are actually several kinds of non-standard crossings: examples listed in figure 7 of [?] are virtual, flat, singular, and twist bar crossings.

Algebraic knots have a concrete geometric interpretation.

1. Virtual knots are obtained if one replaces  $E^3$  as imbedding space with a space which has non-trivial first homology group. This implies that knot can represent a homologically non-trivial curve giving an additional flavor to the unknottedness since homologically non-trivial curve cannot be transformed to a curve which is homologically non-trivial by any continuous deformation.
2. The violent projection to plane leads to the emergence of virtual crossings. The product  $(S^1 \times S^1) \times D$ , where  $(S^1 \times S^1)$  is torus  $D$  is finite line segment, provides the simplest example. Torus can be identified as a rectangle with opposite sides identified and homologically non-trivial knots correspond to curves winding  $n_1$  times around the first  $S^1$  and  $n_2$  times around the second  $S^1$ . These curves are not continuous in the representation where  $S^1 \times S^1$  is rectangle in plane.
3. A simple geometric visualization of virtual crossing is obtained by adding to the plane a handle along which the second strand traverses and in this manner avoids intersection. This visualization allows to understand the geometric motivation for the the virtual moves.

This geometric interpretation is natural in TGD framework where the plane to which the projection occurs corresponds to  $M^2 \subset M^4$  or is replaced with the sphere at the boundary of  $S^2$  and 3-surfaces can have arbitrary topology and partonic 2-surfaces defining as their orbits light-like 3-surfaces can have arbitrary genus.

In TGD framework the situation is however more general than represented by sub-manifold braid theory. Single braid represents the line of generalized Feynman diagram. Vertices represent something new: in the vertex the lines meet and the braid strands are redistributed but do not disappear or pop up from anywhere. That the braid strands can come both from the future and past is also an important generalization. There are physical arguments suggesting that there are only 3-vertices for braids but not higher ones [K16]. The challenge is to represent algebraically the vertices of generalized Feynman diagrams.

### Algebraic knots

The basic idea in the algebraization of knots is rather simple. If  $x$  and  $y$  are the crossing portions of knot, the basic algebraic operation is binary operation giving "the result of  $x$  going under  $y$ ", call it  $x \triangleright y$  telling what happens to  $x$ . "Portion of knot" means the piece of knot between two crossings and  $x \triangleright y$  denotes the portion of knot next to  $x$ . The definition is asymmetrical in  $x$  and  $y$  and the dual of the operation would be  $y \triangleleft x$  would be "the result of  $y$  going above  $x$ ". One can of course ask, why not to define the outcome of the operation as a pair  $(x \triangleleft y, y \triangleright x)$ . This operation would be bi-local in a well-defined sense. One can of course do this: in this case one has binary operation from  $X \times X \rightarrow X \times X$  mapping pairs of portions to pairs of portions. In the first case one has binary operation  $X \times X \rightarrow X$ .

The idea is to abstract this basic idea and replace  $X$  with a set endowed with operation  $\triangleright$  or  $\triangleleft$  or both and formulate the Reidemeister conditions given as conditions satisfied by the algebra. One ends up to four basic algebraic structures kei, quandle, rack, and biquandle.

1. In the case of non-oriented knots the kei is the algebraic structure. Kei - or inventory quandle-is a set  $X$  with a map  $X \times X \rightarrow X$  satisfying the conditions

- (a)  $x \triangleright x = x$  (idempotency, one of the Reidemeister moves)
- (b)  $(x \triangleright y) \triangleright y = x$  (operation is its own right inverse having also interpretation as Reidemeister move)
- (c)  $(x \triangleright y) \triangleright z = (x \triangleright z) \triangleright (y \triangleright z)$  (self-distributivity)

$Z[[t]]/(t^2)$  module with  $x \triangleright y = tx + (1 - t)y$  is a kei.

2. For orientable knot diagram there is preferred direction of travel along knot and one can distinguish between  $\triangleright$  and its right inverse  $\triangleright^{-1}$ . This gives quandle satisfying the axioms

- (a)  $x \triangleright x = x$
- (b)  $(x \triangleright y) \triangleright^{-1} y = (x \triangleright^{-1} y) \triangleright y = x$
- (c)  $(x \triangleright y) \triangleright z = (x \triangleright z) \triangleright (y \triangleright z)$

$Z[t^{\pm 1}]$  module with  $x \triangleright y = tx + (1 - t)y$  is a quandle.

3. One can also introduce framed knots: intuitively one attaches to a knot very near to it. More precise formulation in terms of a section of normal bundle of the knot. This makes possible to speak about self-linking. Reidemeister moves must be modified appropriately. In this case rack is the appropriate structure. It satisfies the axioms of quandle except the first axiom since corresponding operation is not a move anymore. Rack axioms are equivalent with the requirement that functions  $f_y : X \rightarrow X$  defined by  $f_y(x) = x \triangleright y$  are automorphisms of the structure. Therefore the elements of rack represent its morphisms. The modules over  $Z[t^{\pm 1}, s]/s(t + s - 1)$  are racks. Coxeter racks are inner product spaces with  $x \triangleright y$  obtained by reflecting  $x$  across  $y$ .
4. Biquandle consists of arcs connecting the subsequent crossings (both under- and over-) of oriented knot diagram. Biquandle operation is a map  $B : X \times X \rightarrow X \times X$  of order pairs satisfying certain invertibility conditions together with set theoretic Yang-Baxter equation:

$$(B \times I)(I \times B)(B \times I) = (I \times B)(B \times I)(I \times B) .$$

Here  $I : X \rightarrow X$  is the identity map. The three conditions to which Yang-Baxter equation decomposes gives the counterparts of the above discussed axioms. Alexander biquandle is the module  $Z(t^{\pm 1}, s^{\pm 1})$  with  $B(x, y) = (ty + (1 - ts)x, sx)$  where one has  $s \neq 1$ . If one includes virtual, flat and singular crossings one obtains virtual/singular aundles and semiquandles.

### 12.2.3 Generalized Feynman diagrams as generalized braid diagrams?

Zero energy ontology suggests the interpretation of the generalized Feynman diagrams as generalized braid diagrams so that there would be no need for vertices at the fundamental braid strand level. The notion of algebraic braid (or tangle) might allow to formulate this idea more precisely.

#### Could one fuse the notions of braid diagram and Feynman diagram?

The challenge is to fuse the notions of braid diagram and Feynman diagram having quite different origin.

1. All generalized Feynman diagrams are reduced to sub-manifold braid diagrams at microscopic level by bosonic emergence (bosons as pairs of fermionic wormhole throats). Three-vertices appear only for entire braids and are purely topological whereas braid strands carrying quantum numbers are just re-distributed in vertices. No 3-vertices at the really microscopic level! This is an additional nail to the coffin of divergences in TGD Universe.

2. By projecting the braid strands of generalized Feynman diagrams to preferred plane  $M^2 \subset M^4$  (or rather 2-D causal diamond), one could achieve a unified description of non-planar Feynman diagrams and braid diagrams. For Feynman diagrams the intersections have a purely combinatorial origin coming from representations as 2-D diagrams.

For braid diagrams the intersections have different origin and non-planarity has different meaning. The crossings of entire braids analogous to those appearing in non-planar Feynman diagrams should define one particular exotic crossing besides virtual crossings of braid strands due to non-trivial first homology of 3-surfaces.

3. The necessity to choose preferred plane  $M^2$  looks strange from QFT point of view. In TGD framework it is forced by the number theoretic vision in which  $M^2$  represents hyper-complex plane of sub-space of hyper-octonions which is subspace of complexified octonions. The choice of  $M^2$  is also forced by the condition that the choice of quantization axes has a geometric correlate both at the level of imbedding space geometry and the geometry of the "world of classical worlds".
4. Also 2-braid diagrams defined as projections of string world sheets are suggestive and would be defined by a projections to the 3-D boundary of  $CD$  or to  $M^3 \subset M^4$ . They would provide a more concrete stringy illustration about generalized Feynman diagram as analog of string diagram. Another attractive illustration is in terms of dance metaphor with the boundary of  $CD$  defining the 3-D space-like parquette. The duality between space-like and light-like braids is expected to be of importance.

The obvious conjecture is that Feynman amplitudes are a analogous to knot invariants constructible by gradually reducing non-planar Feynman diagrams to planar ones after which the already existing twistor theoretical machinery of  $\mathcal{N} = 4$  SYMs would apply [?].

### Does 2-D integrable QFT dictate the scattering inside the lines of generalized Feynman diagrams

The preferred plane  $M^2$  (more precisely, 2-D causal diamond having also interpretation as Penrose diagram) plays a key role as also the preferred sphere  $S^2$  at the boundary of  $CD$ . It is perhaps not accident that a generalization of braiding was discovered in integrable quantum field theories in  $M^2$ . The S-matrix of this theory is rather trivial looking: particle moving with different velocities cross each other and suffer a phase lag and permutation of 2-momenta which has physical effects only in the case of non-identical particles. The  $R$ -matrix describing this process reduces to the  $R$ -matrix describing the basic braiding operation in braid theories at the static limit.

I have already earlier conjectured that this kind of integrable QFT is part of quantum TGD [?]. The natural guess is that it describes what happens for the projections of 4-momenta in  $M^2$  in scattering process inside lines of generalized Feynman diagrams. If integrable theories in  $M^2$  control this scattering, it would cause only phase changes and permutation of the  $M^2$  projections of the 4-momenta. The most plausible guess is that  $M^2$  QFT characterized by  $R$ -matrix describes what happens to the braid momenta during the free propagation and the remaining challenge would be to understand what happens in the vertices defined by 2-D partonic surfaces at which re-distribution of braid strands takes place.

### How quantum TGD as almost topological QFT differs from topological QFT for braids and 3-manifolds

One must distinguish between two topological QFTs. These correspond to topological QFT defining braid invariants and invariants of 3-manifolds respectively. The reason is that knots are an essential element in the procedure yielding 3-manifolds. Both 3-manifold invariants and knot invariants would be defined as Wilson loops involving path integral over gauge connections for a given 3-manifold with exponent of non-Abelian Chern-Simons action defining the weight.

1. In TGD framework the topological QFT producing braid invariants for a given 3-manifold is replaced with sub-manifold braid theory. Kähler action reduces Chern-Simons terms for preferred extremals and only these contribute to the functional integral. What is the counterpart of

topological invariance in this framework? Are general isotopies allowed or should one allow only sub-group of symplectic group of  $CD$  boundary leaving the end points of braids invariant? For this option Reidemeister moves are undetectable in the finite measurement resolution defined by the subgroup of the symplectic group. Symplectic transformations would not affect 3-surfaces as the analogs of abstract contact manifold since induced Kähler form would not be affected and only the imbedding would be changed.

In the approach based on inclusions of HFFs gauge invariance or its generalizations would represent finite measurement resolution (the action of included algebra would generate states not distinguishable from the original one).

2. There is also ordinary topological QFT allowing to construct topological invariants for 3-manifold. In TGD framework the analog of topological QFT is defined by Chern-Simons-Kähler action in the space of preferred 3-surfaces. Now one sums over small deformations of 3-surface instead of gauge potentials. If extremals of Chern-Simons-Kähler action are in question, symplectic invariance is the most that one can hope for and this might be the situation quite generally. If all light-like 3-surfaces are allowed so that only weak form of electric-magnetic duality at them would bring metric into the theory, it might be possible to have topological invariance at 3-D level but not at 4-D level. It however seems that symplectic invariance with respect to subgroup leaving end points of braids invariant is the realistic expectation.

### Could the allowed braids define Legendrian sub-manifolds of contact manifolds?

The basic questions concern the identification of braids and 2-braids. In quantum TGD they cannot be arbitrary but determined by dynamics providing space-time correlates for quantum dynamics. The deformations of braids should mean also deformations of 3-surfaces which as topological manifolds would however remain as such. Therefore topological QFT for given 3-manifold with path integral over gauge connections would in TGD correspond to functional integral of 3-surfaces corresponding to same topology even symplectic structure. The quantum fluctuating degrees of freedom indeed correspond to symplectic group divided by its subgroup defining measurement resolution.

What is the dynamics defining the braids strands? What selects them? I have considered this problem several times. Just two examples is enough here.

1. Could they be some special light-like curves? Could the condition that the end points of the curves correspond to rational points in some preferred coordinates allow to select these light-like curves? But what about light-like curves associated with the ends of the space-time surface?
2. The solutions of modified Dirac equation [?] are localized to curves by using the analog of periodic boundary conditions: the length of the curve is quantized in the effective metric defined by the modified gamma matrices. Here one however introduced a coordinate along light-like 3-surface and it is not clear how one should fix this preferred coordinate.

#### 1. Legendrian and Lagrangian sub-manifolds

A hint about what is missing comes from the observation that a non-vanishing Chern-Simons-Kähler form  $A$  defines a contact structure [?] at light-like 3-surfaces if one has  $A \wedge dA \neq 0$ . This condition states complete non-integrability of the distribution of 2-planes defined by the condition  $A_\mu t^\mu = 0$ , where  $t$  is tangent vector in the tangent bundle of light-like 3-surface. It also states that the flow lines of  $A$  do *not* define global coordinate varying along them.

1. It is however possible to have 1-dimensional curves for which  $A_\mu t^\mu = 0$  holds true at each point. These curves are known as Legendrian sub-manifolds to be distinguished from Lagrangian manifolds for which the projection of symplectic form expressible locally as  $J = dA$  vanishes. The set of this curves is discrete so that one obtains braids. Legendrian knots are the simplest example of Legendrian sub-manifolds and the question is whether braid strands could be identified as Legendrian knots. For Legendrian braids symplectic invariance replaces topological invariance and Legendrian knots and braids can be trivial in topological sense. In some situations the property of being Legendrian implies un-knottedness.

2. For Legendrian braid strands the Kähler gauge potential vanishes. Since the solutions of the modified Dirac equation are localized to braid strands, this means that the coupling to Kähler gauge potential vanishes. From physics point of view a generalization of Legendre braid strand by allowing gauge transformations  $A \rightarrow A + d\Phi$  looks natural since it means that the coupling of induced spinors is pure gauge terms and can be eliminated by a gauge transformation.

### 2. 2-D duals of Legendrian sub-manifolds

One can consider also what might be called 2-dimensional duals of Legendrian sub-manifolds.

1. Also the one-form obtained from the dual of Kähler magnetic field defined as  $B^\mu = \epsilon^{\mu\nu\gamma} J_{\nu\gamma}$  defines a distribution of 2-planes. This vector field is ill-defined for light-like surfaces since contravariant metric is ill-defined. One can however multiply  $B$  with the square root of metric determining formally so that metric would disappear completely just as it disappears from Chern-Simons action. This looks however somewhat tricky mathematically. At the 3-D space-like ends of space-time sheets at boundaries of  $CD$   $B^\mu$  is however well-defined as such.
2. The distribution of 2-planes is integrable if one has  $B \wedge dB = 0$  stating that one has Beltrami field: physically the conditions states that the current  $dB$  feels no Lorentz force. The geometric content is that  $B$  defines a global coordinate varying along its flow lines. For the preferred extremals of Kähler action Beltrami condition is satisfied by isometry currents and Kähler current in the interior of space-time sheets. If this condition holds at 3-surfaces, one would have an global time coordinate and integrable distribution of 2-planes defining a slicing of the 2-surface. This would realize the conjecture that space-time surface has a slicing by partonic 2-surfaces. One could say that the 2-surfaces defined by the distribution are orthogonal to  $B$ . This need not however mean that the projection of  $J$  to these 2-surfaces vanishes. The condition  $B \wedge dB = 0$  on the space-like 3-surfaces could be interpreted in terms of effective 2-dimensionality. The simplest option posing no additional conditions would allow two types of braids at space-like 3-surfaces and only Legendrian braids at light-like 3-surfaces.

These observations inspire a question. Could it be that the conjectured dual slicings of space-time sheets by space-like partonic 2-surfaces and by string world sheets are defined by  $A_\mu$  and  $B^\mu$  respectively associated with slicings by light-like 3-surfaces and space-like 3-surfaces? Could partonic 2-surfaces be identified as 2-D duals of 1-D Legendrian sub-manifolds?

The identification of braids as Legendrian braids for light-like 3-surfaces and with Legendrian braids or their duals for space-like 3-surfaces would in turn imply that topological braid theory is replaced with a symplectic braid theory in accordance with the view about TGD as almost topological QFT. If finite measurement resolution corresponds to the replacement of symplectic group with the coset space obtained by dividing by a subgroup, symplectic subgroup would take the role of isotopies in knot theory. This symplectic subgroup could be simply the symplectic group leaving the end points of braids invariant.

### An attempt to identify the constraints on the braid algebra

The basic problems in understanding of quantum TGD are conceptual. One must proceed by trying to define various concepts precisely to remove the many possible sources of confusion. With this in mind I try collect essential points about generalized Feynman diagrams and their relation to braid diagrams and Feynman diagrams and discuss also the most obvious constraints on algebraization.

Let us first summarize what generalized Feynman diagrams are.

1. Generalized Feynman diagrams are 3-D (or 4-D, depends on taste) objects inside  $CD \times CP_2$ . Ordinary Feynman diagrams are in plane. If finite measurement resolution has as a space-time correlate discretization at the level of partonic 2-surfaces, both space-like and light-like 3-surfaces reduce to braids and the lines of generalized Feynman diagrams correspond to braids. It is possible to obtain the analogs of ordinary Feynman diagrams by projection to  $M^2 \subset M^4$  defined uniquely for given  $CD$ . The resulting apparent intersections would represent ne particular kind of exotic intersection.

2. Light-like 3-surfaces define the lines of generalized Feynman diagrams and the braiding results naturally. Non-trivial first homology for the orbits of partonic 2-surfaces with genus  $g > 0$  could be called homological virtual intersections.
3. It zero energy ontology braids must be characterized by time orientation. Also it seems that one must distinguish in zero energy ontology between on mass shell braids and off mass shell braid pairs which decompose to pairs of braids with positive and negative energy massless on mass shell states. In order to avoid confusion one should perhaps speak about tangles inside  $CD$  rather than braids. The operations of the algebra are same except that the braids can end either to the upper or lower light-like boundary of  $CD$ . The projection to  $M^2$  effectively reduces the  $CD$  to a 2-dimensional causal diamond.
4. The vertices of generalized Feynman diagrams are partonic 2-surfaces at which the light-like 3-surfaces meet. This is a new element. If the notion of bosonic emergence is accepted no  $n > 2$ -vertices are needed so that braid strands are redistributed in the reaction vertices. The redistribution of braid strands in vertices must be introduced as an additional operation somewhat analogous to  $\triangleright$  and the challenge is to reduce this operation to something simple. Perhaps the basic operation reduces to an exchange of braid strand between braids. The process can be seen as a decay of of braid with the conservation of braid strands with strands from future and past having opposite strand numbers. Also for this operation the analogs of Reidemeister moves should be identified. In dance metaphor this operation corresponds to a situation in which the dancer leaves the group to which it belongs and goes to a new one.
5. A fusion of Feynman diagrammatic non-planarity and braid theoretic non-planarity is needed and the projection to  $M^2$  could provide this fusion when at least two kinds of virtual crossings are allowed. The choice of  $M^2$  could be global. An open question is whether the choice of  $M^2$  could characterize separately each line of generalized Feynman diagram characterized by the four-momentum associated with it in the rest system defined by the tips of  $CD$ . Somehow the theory should be able to fuse the braiding matrix for integrable QFT in  $M^2$  applying to entire braids with the braiding matrix for braid theory applying at the level of single braid.

Both integral QFTs in  $M^2$  and braid theories suggest that biquandle structure is the structure that one should try to generalized.

1. The representations of resulting bi-quandle like structure could allow abstract interesting information about generalized Feynman diagrams themselves but the dream is to construct generalized Feynman diagrams as analogs of knot invariants by a recursive procedure analogous to un-knotting of a knot.
2. The analog of bi-quandle algebra should have a hierarchical structure containing braid strands at the lowest level, braids at next level, and braids of braids...of braids at higher levels. The notion of operad would be ideal for formulating this hierarchy and I have already proposed that this notion must be essential for the generalized Feynman diagrammatics. An essential element is the vanishing of total strand number in the vertex (completely analogous to conserved charged such as fermion number). Again a convenient visualization is in terms of dancers forming dynamical groups, forming groups of groups forming .....

I have already earlier suggested [?] that the notion of operad [?] relying on permutation group and its subgroups acting in tensor products of linear spaces is central for understanding generalized Feynman diagrams.  $n \rightarrow n_1 + n_2$  decay vertex for  $n$ -braid would correspond to "symmetry breaking"  $S_n \rightarrow S_{n_1} \times S_{n_2}$ . Braid group represents the covering of permutation group so that braid group and its subgroups permuting braids would suggest itself as the basic group theoretical notion. One could assign to each strand of  $n$ -braid decaying to  $n_1$  and  $n_2$  braids a two-valued color telling whether it becomes a strand of  $n_1$ -braid or  $n_2$ -braid. Could also this "color" be interpreted as a particular kind of exotic crossing?

3. What could be the analogs of Reidemeister moves for braid strands?
  - (a) If the braid strands are dynamically determined, arbitrary deformations are not possible. If however all isotopy classes are allowed, the interpretation would be that a kind of gauge

choice selecting one preferred representation of strand among all possible ones obtained by continuous deformations is in question.

- (b) Second option is that braid strands are dynamically determined within finite measurement resolution so that one would have braid theory in given length scale resolution.
  - (c) Third option is that topological QFT is replaced with symplectic QFT: this option is suggested by the possibility to identify braid strands as Legendrian knots or their duals. Subgroup of the symplectic group leaving the end points of braids invariant would act as the analog of continuous transformations and play also the role of gauge group. The new element is that symplectic transformations affect partonic 2-surfaces and space-time surfaces except at the end points of braid.
4. Also 2-braids and perhaps also 2-knots could be useful and would provide string theory like approach to TGD. In this case the projections could be performed to the ends of  $CD$  or to  $M^3$ , which can be identified uniquely for a given  $CD$ .
  5. There are of course many additional subtleties involved. One should not forget loop corrections, which naturally correspond to sub- $CD$ s. The hierarchy of Planck constants and number theoretical universality bring in additional complexities.

All this looks perhaps hopelessly complex but the Universe around is complex even if the basic principles could be very simple.

#### 12.2.4 About string world sheets, partonic 2-surfaces, and two-knots

String world sheets and partonic 2-surfaces provide a beautiful visualization of generalized Feynman diagrams as braids and also support for the duality of string world sheets and partonic 2-surfaces as duality of light-like and space-like braids. Dance metaphor is very helpful here.

1. The projection of string world sheets and partonic 2-surfaces to 3-D space replaces knot projection. In TGD context this 3-D of space could correspond to the 3-D light-like boundary of  $CD$  and 2-knot projection would correspond to the projection of the braids associated with the lines of generalized Feynman diagram. Another identification would be as  $M^1 \times E^2$ , where  $M^1$  is the line connecting the tips of  $CD$  and  $E^2$  the orthogonal complement of  $M^2$ .
2. Using dance metaphor for light-like braiding, braids assignable to the lines of generalized Feynman diagrams would correspond to groups of dancers. At vertices the dancing groups would exchange members and completely new groups would be formed by the dancers. The number of dancers (negative for those dancing in the reverse time direction) would be conserved. Dancers would be connected by threads representing strings having braid points at their ends. During the dance the light-like braiding would induce space-like braiding as the threads connecting the dancers would get entangled. This would suggest that the light-like braids and space-like braidings are equivalent in accordance with the conjectured duality between string-world sheets and partonic 2-surfaces. The presence of genuine 2-knottedness could spoil this equivalence unless it is completely local.

Can string world sheets and partonic 2-surfaces get knotted?

1. Since partonic 2-surfaces (wormhole throats) are imbedded in light-cone boundary, the preferred 3-D manifolds to which one can project them is light-cone boundary (boundary of  $CD$ ). Since the projection reduces to inclusion these surfaces cannot get knotted. Only if the partonic 2-surfaces contains in its interior the tip of the light-cone something non-trivial identifiable as virtual 2-knottedness is obtained.
2. One might argue that the conjectured duality between the descriptions provided by partonic 2-surfaces and string world sheets requires that also string world sheets represent trivial 2-braids. I have shown earlier that nontrivial local knots glued to the string world sheet require that  $M^4$  time coordinate has a local maximum. Does this mean that 2-knots are excluded? This is not obvious: TGD allows also regions of space-time surface with Euclidian signature and generalized Feynman graphs as 4-D space-time regions are indeed Euclidian. In these regions string world sheets could get knotted.

What happens for knot diagrams when the dimension of knot is increased to two? According to the articles of Nelson [?] and Carter [?] the crossings for the projections of braid strands are replaced with more complex singularities for the projections of 2-knots. One can decompose the 2-knots to regions surrounded by boxes. Box can contain just single piece of 2-D surface; it can contain two intersection pieces of 2-surfaces as the counterpart of intersecting knot strands and one can tell which of them is above which; the box can contain also a discrete point in the intersection of projections of three disjoint regions of knot which consists of discrete points; and there is also a box containing so called cone point. Unfortunately, I failed to understand the meaning of the cone point.

For 2-knots Reidemeister moves are replaced with Roseman moves. The generalization would allow virtual self intersections for the projection and induced by the non-trivial second homology of 4-D imbedding space. In TGD framework elementary particles have homologically non-trivial partonic 2-surfaces (magnetic monopoles) as their building bricks so that even if 2-knotting in standard sense might be not allowed, virtual 2-knotting would be possible. In TGD framework one works with a subgroup of symplectic transformations defining measurement resolution instead of isotopies and this might reduce the number of allowed mov

### The dynamics of string world sheets and the expression for Kähler action

The dynamics of string world sheets is an open question. Effective 2-dimensionality suggests that Kähler action for the preferred extremal should be expressible using 2-D data but there are several guesses for what the explicit expression could be, and one can only make only guesses at this moment and apply internal consistency conditions in attempts to kill various options.

#### 1. *Could weak form of electric-magnetic duality hold true for string world sheets?*

If one believes on duality between string world sheets and partonic 2-surfaces, one can argue that string world sheets are most naturally 2-surfaces at which the weak form of electric magnetic duality holds true. One can even consider the possibility that the weak form of electric-magnetic duality holds true only at the the string world sheets and partonic 2-surfaces but not at the preferred 3-surfaces.

1. The weak form of electric magnetic duality would mean that induced Kähler form is non-vanishing at them and Kähler magnetic flux over string world sheet is proportional to Kähler electric flux.
2. The flux of the induced Kähler form of  $CP_2$  over string world sheet would define a dimensionless "area". Could Kähler action for preferred extremals reduces to this flux apart from a proportionality constant. This "area" would have trivially extremum with respect to symplectic variations if the braid strands are Legendrian sub-manifolds since in this case the projection of Kähler gauge potential on them vanishes. This is a highly non-trivial point and favors weak form of electric-magnetic duality and the identification of Kähler action as Kähler magnetic flux. This option is also in spirit with the vision about TGD as almost topological QFT meaning that induced metric appears in the theory only via electric-magnetic duality.
3. Kähler magnetic flux over string world sheet has a continuous spectrum so that the identification as Kähler action could make sense. For partonic 2-surfaces the magnetic flux would be quantized and give constant term to the action perhaps identifiable as the contribution of  $CP_2$  type vacuum extremals giving this kind of contribution.

The change of space-time orientation by changing the sign of permutation symbol would change the sign in electric-magnetic duality condition and would not be a symmetry. For a given magnetic charge the sign of electric charge changes when orientation is changed. The value of Kähler action does not depend on space-time orientation but weak form of electric-magnetic duality as boundary condition implies dependence of the Kähler action on space-time orientation. The change of the sign of Kähler electric charge suggests the interpretation of orientation change as one aspect of charge conjugation. Could this orientation dependence be responsible for matter antimatter asymmetry?

#### 2. *Could string world sheets be Lagrangian sub-manifolds in generalized sense?*

Legendrian sub-manifolds can be lifted to Lagrangian sub-manifolds [?] Could one generalize this by replacing Lagrangian sub-manifold with 2-D sub-manifold of space-times surface for which the projection of the induced Kähler form vanishes? Could string world sheets be Lagrangian sub-manifolds?



I have also proposed that the inverse image of homologically non-trivial sphere of  $CP_2$  under imbedding map could define counterparts of string world sheets or partonic 2-surfaces. This conjecture does not work as such for cosmic strings, massless extremals having 2-D projection since the inverse image is in this case 4-dimensional. The option based on homologically non-trivial geodesic sphere is not consistent with the identification as analog of Lagrangian manifold but the identification as the inverse image of homologically trivial geodesic sphere is.

The most general option suggested is that string world sheet is mapped to 2-D Lagrangian sub-manifold of  $CP_2$  in the imbedding map. This would mean that theory is exactly solvable at string world sheet level. Vacuum extremals with a vanishing induced Kähler form would be exceptional in this framework since they would be mapped as a whole to Lagrangian sub-manifolds of  $CP_2$ . The boundary condition would be that the boundaries of string world sheets defined by braids at preferred 3-surfaces are Legendrian sub-manifolds. The generalization would mean that Legendrian braid strands could be continued to Lagrangian string world sheets for which induced Kähler form vanishes. The physical interpretation would be that if particle moves along this kind of string world sheet, it feels no covariant Lorentz-Kähler force and contra variant Lorentz forces is orthogonal to the string world sheet.

There are however serious objections.

1. This proposal does not respect the proposed duality between string world sheets and partonic 2-surfaces which as carries of Kähler magnetic charges cannot be Lagrangian 2-manifolds.
2. One loses the elegant identification of Kähler action as Kähler magnetic flux since Kähler magnetic flux vanishes. Apart from proportionality constant Kähler electric flux

$$\int_{Y^2} *J$$

is as a dimensionless scaling invariant a natural candidate for Kähler action but need not be extremum if braids are Legendrian sub-manifolds whereas for Kähler magnetic flux this is the case. There is however an explicit dependence on metric which does not conform with the idea that almost topological QFT is symplectic QFT.

3. The sign factor of the dual flux which depends on the orientation of the string world sheet and thus changes sign when the orientation of space-time sheet is changed by changing that of the string world sheet. This is in conflict with the independence of Kähler action on orientation. One can however argue that the orientation makes itself actually physically visible via the weak form of electric-magnetic duality. If the above discussed duality holds true, the net contribution to Kähler action would vanish as the total Kähler magnetic flux for partonic 2-surfaces. Therefore the duality cannot hold true if Kähler action reduces to dual flux.
4. There is also a purely formal counter argument. The inverse images of Lagrangian sub-manifolds of  $CP_2$  can be 4-dimensional (cosmic strings and massless extremals) whereas string world sheets are 2-dimensional.

### String world sheets as minimal surfaces

Effective 2-dimensionality suggests a reduction of Kähler action to Chern-Simons terms to the area of minimal surfaces defined by string world sheets holds true [?]. Skeptic could argue that the expressibility of Kähler action involving no dimensional parameters except  $CP_2$  scaled does not favor this proposal. The connection of minimal surface property with holomorphy and conformal invariance however forces to take the proposal seriously and it is easy to imagine how string tension emerges since the size scale of  $CP_2$  appears in the induced metric [?].

One can ask whether the minimal surface property conforms with the proposal that string worlds sheets obey the weak form of electric-magnetic duality and with the proposal that they are generalized Lagrangian sub-manifolds.

1. The basic answer is simple: minimal surface property and possible additional conditions (Lagrangian sub-manifold property or the weak form of electric magnetic duality) poses only additional conditions forcing the space-time sheet to be such that the imbedded string world sheet is

a minimal surface of space-time surface: minimal surface property is a condition on space-time sheet rather than string world sheet. The weak form of electric-magnetic duality is favored because it poses conditions on the first derivatives in the normal direction unlike Lagrangian sub-manifold property.

2. Any proposal for 2-D expression of Kähler action should be consistent with the proposed real-octonion analytic solution ansatz for the preferred extremals [K9]. The ansatz is based on real-octonion analytic map of imbedding space to itself obtained by algebraically continuing real-complex analytic map of 2-D sub-manifold of imbedding space to another such 2-D sub-manifold. Space-time surface is obtained by requiring that the "imaginary" part of the map vanishes so that image point is hyper-quaternion valued. Wick rotation allows to formulate the conditions using octonions and quaternions. Minimal surfaces (of space-time surface) are indeed objects for which the imbedding maps are holomorphic and the real-octonion analyticity could be perhaps seen as algebraic continuation of this property.
3. Does Kähler action for the preferred extremals reduce to the area of the string world sheet or to Kähler magnetic flux or are the representations equivalent so that the induced Kähler form would effectively define area form? If the Kähler form associated with the induced metric on string world sheet is proportional to the induced Kähler form the Kähler magnetic flux is proportional to the area and Kähler action reduces to genuine area. Could one pose this condition as an additional constraint on string world sheets? For Lagrangian sub-manifolds Kähler electric field should be proportional to the area form and the condition involves information about space-time surface and is therefore more complex and does not look plausible.

### Explicit conditions expressing the minimal surface property of the string world sheet

It is instructive to write explicitly the condition for the minimal surface property of the string world sheet and for the reduction of the area Kähler form to the induced Kähler form. For string world sheets with Minkowskian signature of the induced metric Kähler structure must be replaced by its hyper-complex analog involving hyper-complex unit  $e$  satisfying  $e^2 = 1$  but replaced with real unit at the level hyper-complex coordinates.  $e$  can be represented as antisymmetric Kähler form  $J_g$  associated with the induced metric but now one has  $J_g^2 = g$  instead of  $J_g^2 = -g$ . The condition that the signed area reduces to Kähler electric flux means that  $J_g$  must be proportional to the induced Kähler form:  $J_g = kJ$ ,  $k = \text{constant}$  in a given space-time region.

One should make an educated guess for the imbedding of the string world sheet into a preferred extremal of Kähler action. To achieve this it is natural to interpret the minimal surface property as a condition for the preferred Kähler extremal in the vicinity of the string world sheet guaranteeing that the sheet is a minimal surface satisfying  $J_g = kJ$ . By the weak form of electric-magnetic duality partonic 2-surfaces represent both electric and magnetic monopoles. The weak form of electric-magnetic duality requires for string world sheets that the Kähler magnetic field at string world sheet is proportional to the component of the Kähler electric field parallel to the string world sheet. Kähler electric field is assumed to have component only in the direction of string world sheet.

#### 1. Minkowskian string world sheets

Let us try to formulate explicitly the conditions for the reduction of the signed area to Kähler electric flux in the case of Minkowskian string world sheets.

1. Let us assume that the space-time surface in Minkowskian regions has coordinates  $(u, v, w, \bar{w})$  [K9]. The pair  $(u, v)$  defines light-like coordinates at the string world sheet having identification as hyper-complex coordinates with hyper-complex unit satisfying  $e = 1$ .  $u$  and  $v$  need not - nor cannot as it turns out - be light-like with respect to the metric of the space-time surface. One can use  $(u, v)$  as coordinates for string world sheet and assume that  $w = x^1 + ix^2$  and  $\bar{w}$  are constant for the string world sheet. Without a loss of generality one can assume  $w = \bar{w} = 0$  at string world sheet.
2. The induced Kähler structure must be consistent with the metric. This implies that the induced metric satisfies the conditions

$$g_{uu} = g_{vv} = 0 . \quad (12.2.1)$$

The analogs of these conditions in regions with Euclidian signature would be  $g_{zz} = g_{\bar{z}\bar{z}} = 0$ .

3. Assume that the imbedding map for space-time surface has the form

$$s^m = s^m(u, v) + f^m(u, v, x^m)_{kl} x^k x^l , \quad (12.2.2)$$

so that the conditions

$$\partial_l k s^m = 0 , \quad \partial_k \partial_u s^m = 0 , \quad \partial_k \partial_v s^m = 0 \quad (12.2.3)$$

are satisfied at string world sheet. These conditions imply that the only non-vanishing components of the induced  $CP_2$  Kähler form at string world sheet are  $J_{uv}$  and  $J_{w\bar{w}}$ . Same applies to the induced metric if the metric of  $M^4$  satisfies these conditions (no non-vanishing components of form  $m_{uk}$  or  $m_{vk}$ ).

4. Also the following conditions hold true for the induced metric of the space-time surface

$$\partial_k g_{uv} = 0 , \quad \partial_u g_{kv} = 0 , \quad \partial_v g_{ku} = 0 . \quad (12.2.4)$$

at string world sheet as is easy to see by using the ansatz.

Consider now the minimal surface conditions stating that the trace of the four components of the second fundamental form whose components are labelled by the coordinates  $\{x^\alpha\} \equiv (u, v, w, \bar{w})$  vanish for string world sheet.

1. Since only  $g_{uv}$  is non-vanishing, only the components  $H_{uv}^k$  of the second fundamental form appear in the minimal surface equations. They are given by the general formula

$$\begin{aligned} H_{uv}^\alpha &= H^\gamma P_\gamma^\alpha , \\ H^\alpha &= (\partial_u \partial_v x^\alpha + (\beta \gamma)^\alpha \partial_u x^\beta \partial_v x^\gamma) . \end{aligned} \quad (12.2.5)$$

Here  $P_\gamma^\alpha$  is the projector to the normal space of the string world sheet. Formula contains also Christoffel symbols  $(\beta \gamma)^\alpha$ .

2. Since the imbedding map is simply  $(u, v) \rightarrow (u, v, 0, 0)$  all second derivatives in the formula vanish. Also  $H^k = 0, k \in \{w, \bar{w}\}$  holds true. One has also  $\partial_u x^\alpha = \delta_u^\alpha$  and  $\partial_v x^\beta = \delta_v^\beta$ . This gives

$$H^\alpha = (u \ v)^\alpha . \quad (12.2.6)$$

All these Christoffel symbols however vanish if the assumption  $g_{uu} = g_{vv} = 0$  and the assumptions about imbedding ansatz hold true. Hence a minimal surface is in question.

Consider now the conditions on the induced metric of the string world sheet

1. The conditions reduce to

$$g_{uu} = g_{vv} = 0 . \quad (12.2.7)$$

The conditions on the diagonal components of the metric are the analogs of Virasoro conditions fixing the coordinate choices in string models. The conditions state that the coordinate lines for  $u$  and  $v$  are light-like curves in the induced metric.

2. The conditions can be expressed directly in terms of the induced metric and read

$$\begin{aligned} m_{uu} + s_{kl} \partial_u s^k \partial_u s^l &= 0 , \\ m_{vv} + s_{kl} \partial_v s^k \partial_v s^l &= 0 . \end{aligned} \quad (12.2.8)$$

The  $CP_2$  contribution is negative for both equations. The conditions make sense only for ( $m_{uu} > 0, m_{vv} > 0$ ). Note that the determinant condition  $m_{uu}m_{vv} - m_{uv}m_{vu} < 0$  expresses the Minkowskian signature of the  $(u, v)$  coordinate plane in  $M^4$ .

The additional condition states

$$J_{uv}^g = kJ_{uv} . \quad (12.2.9)$$

It reduces signed area to Kähler electric flux. If the weak form of electric-magnetic duality holds true one can interpret the area as magnetic flux defined as the flux of the dual of induced Kähler form over space-like surface and defining electric charge. A further condition is that the boundary of string world sheet is Legendrean manifold so that the flux and thus area is extremized also at the boundaries.

### 2. Conditions for the Euclidian string world sheets

One can do the same calculation for string world sheet with Euclidian signature. The only difference is that  $(u, v)$  is replaced with  $(z, \bar{z})$ . The imbedding map has the same form assuming that space-time sheet with Euclidian signature allows coordinates  $(z, \bar{z}, w, \bar{w})$  and the local conditions on the imbedding are a direct generalization of the above described conditions. In this case the vanishing for the diagonal components of the string world sheet metric reads as

$$\begin{aligned} h_{kl} \partial_z s^k \partial_z s^l &= 0 , \\ h_{kl} \partial_{\bar{z}} s^k \partial_{\bar{z}} s^l &= 0 . \end{aligned} \quad (12.2.10)$$

The natural ansatz is that complex  $CP_2$  coordinates are holomorphic functions of the complex coordinates of the space-time sheet.

### 3. Wick rotation for Minkowskian string world sheets leads to a more detailed solution ansatz

Wick rotation is a standard trick used in string models to map Minkowskian string world sheets to Euclidian ones. Wick rotation indeed allows to define what one means with real-octonion analyticity. Could one identify string world sheets in Minkowskian regions by using Wick rotation and does this give the same result as the direct approach?

Wick rotation transforms space-time surfaces in  $M^4 \times CP_2$  to those in  $E^4 \times CP_2$ . In  $E^4 \times CP_2$  octonion real-analyticity is a well-defined notion and one can identify the space-time surfaces surfaces at which the imaginary part of of octonion real-analytic function vanishes: imaginary part is defined via the decomposition of octonion to two quaternions as  $o = q_1 + Iq_2$  where  $I$  is a preferred octonion unit. The reverse of the Wick rotation maps the quaternionic surfaces to what might be called hyper-quaternionic surfaces in  $M^4 \times CP_2$ .

In this picture string world sheets would be hyper-complex surfaces defined as inverse imagines of complex surfaces of quaternionic space-time surface obtained by the inverse of Wick rotation. For this

approach to be equivalent with the above one it seems necessary to require that the the treatment of the conditions on metric should be equivalent to that for which hyper-complex unit  $e$  is not put equal to 1. This would mean that the conditions reduce to independent conditions for the real and imaginary parts of the real number formally represented as hyper-complex number with  $e = 1$ .

Wick rotation allows to guess the form of the ansatz for  $CP_2$  coordinates as functions of space-time coordinates In Euclidian context holomorphich functions of space-time coordinates are the natural ansatz. Therefore the natural guess is that one can map the hypercomplex number  $t \pm ez$  to complex coordinate  $t \pm iz$  by the analog of Wick rotation and assume that  $CP_2$  complex coordinates are analytic functions of the complex space-time coordinates obtained in this manner.

The resulting induced metric could be obtained directly using real coordinates  $(t, z)$  for string world sheet or by calculating the induced metric in complex coordinates  $t \pm iz$  and by mapping the expressions to hyper-complex numbers by Wick rotation (by replacing  $i$  with  $e = 1$ ). If the diagonal components of the induced metric vanish for  $t \pm iz$  they vanish also for hyper-complex coordinates so that this approach seem to make sense.

**Electric-magnetic duality for flux Hamiltonians and the existence of Wilson sheets**

One must distinguish between two conjectured dualities. The weak form of electric-magnetic duality and the duality between string world sheets and partonic 2-surfaces. Could the first duality imply equivalence of not only electric and magnetic flux Hamiltonians but also electric and magnetic Wilson sheets? Could the latter duality allow two different representations of flux Hamiltonians?

1. For electric-magnetic duality holding true at string world sheets one would have non-vanishing Kähler form and the fluxes would be non-vanishing. The Hamiltonian fluxes

$$Q_{m,A} = \int_{X^2} JH_A dx^1 dx^2 = \int_{X^2} H_A J_{\alpha\beta} dx^\alpha \wedge dx^\beta \tag{12.2.11}$$

for partonic 2-surfaces  $X^2$  define WCW Hamiltonians playing a key role in the definition of WCW Kähler geometry. They have also interpretation as a generalization of Wilson loops to Wilson 2-surfaces.

2. Weak form of electric magnetic duality would imply both at partonic 2-surfaces and string world sheets the proportionality

$$Q_{m,A} = \int_{X^2} JH_A dx^1 \wedge dx^2 \propto Q_{m,A}^* = \int_{X^2} H_A * J_{\alpha\beta} dx^\alpha \wedge dx^\beta . \tag{12.2.12}$$

Therefore the electric-magnetic duality would have a concrete meaning also at the level of WCW geometry.

3. If string world sheets are Lagrangian sub-manifolds Hamiltonian fluxes would vanish identically so that the identification as Wilson sheets does not make sense. One would lose electric-magnetic duality for flux sheets. The dual fluxes

$$*Q_A = \int_{Y^2} *JH_A dx^1 \wedge dx^2 = \int_{Y^2} \epsilon_{\alpha\beta}{}^{\gamma\delta} J_{\gamma\delta} = \int_{Y^2} \frac{\sqrt{\det(g_A)}}{\det(g_2^{\perp})} J_{34}^{\perp} dx^1 \wedge dx^2$$

for string world sheets  $Y^2$  are however non-vanishing. Unlike fluxes, the dual fluxes depend on the induced metric although they are scaling invariant.

Under what conditions the conjectured duality between partonic 2-surface and string world sheets hold true at the level of WCW Hamiltonians?

1. For the weak form of electric-magnetic duality at string world sheets the duality would mean that the sum of the fluxes for partonic 2-surfaces and sum of the fluxes for string world sheets are identical apart from a proportionality constant:

$$\sum_i Q_A(X_i^2) \propto \sum_i Q_A(Y_i^2) . \quad (12.2.13)$$

Note that in zero ontology it seems necessary to sum over all the partonic surfaces (at both ends of the space-time sheet) and over all string world sheets.

2. For Lagrangian sub-manifold option the duality can hold true only in the form

$$\sum_i Q_A(X_i^2) \propto \sum_i Q_A^*(Y_i^2) . \quad (12.2.14)$$

Obviously this option is less symmetric and elegant.

### Summary

There are several arguments favoring weak form of electric-magnetic duality for both string world sheets and partonic 2-surfaces. Legendrian sub-manifold property for braid strands follows from the assumption that Kähler action for preferred extremals is proportional to the Kähler magnetic flux associated with preferred 2-surfaces and is stationary with respect to the variations of the boundary. What is especially nice is that Legendrian sub-manifold property implies automatically unique braids. The minimal option favored by the idea that 3-surfaces are basic dynamical objects is the one for which weak form of electric-magnetic duality holds true only at partonic 2-surfaces and string world sheets. A stronger option assumes it at preferred 3-surfaces. Duality between string world sheets and partonic 2-surfaces suggests that WCW Hamiltonians can be defined as sums of Kähler magnetic fluxes for either partonic 2-surfaces or string world sheets.

### 12.2.5 What generalized Feynman rules could be?

After all these explanations the skeptic reader might ask whether this lengthy discussion gives any idea about what the generalized Feynman rules might look like. The attempt to answer this question is a good manner to make a map about what is understood and what is not understood. The basic questions are simple. What constraints does zero energy ontology (ZEO) pose? What does the necessity to project the four-momenta to a preferred plane  $M^2$  mean? What mathematical expressions one should assign to the propagator lines and vertices? How does one perform the functional integral over 3-surfaces in finite measurement resolution? The following represents tentative answers to these questions but does not say much about exact role of algebraic knots.

#### Zero energy ontology

ZEO poses very powerful constraints on generalized Feynman diagrams and gives hopes that both UV and IR divergences cancel.

1. ZEO predicts that the fermions assigned with braid strands associated with the virtual particles are on mass shell massless particles for which the sign of energy can be also negative: in the case of wormhole throats this can give rise to a tachyonic exchange.
2. The on mass shell conditions for each wormhole throat in the diagram involving loops are very stringent and expected to eliminate very large classes of diagrams. If however given diagonal diagram leading from n-particle state to the same n-particle state -completely analogous to self energy diagram- is possible then the ladders form by these diagrams are also possible and one obtains infinite of this kind of diagrams as generalized self energy correction and is excellent hopes that geometric series gives a closed algebraic function.

3. IR divergences plaguing massless theories are cancelled if the incoming and outgoing particles are massive bound states of massless on mass shell particles. In the simplest manner this is achieved when the 3-momenta are in opposite direction. For internal lines the massive on-mass shell-condition is not needed at all. Therefore there is an almost complete separation of the problem how bound state masses are determined from the problem of constructing the scattering amplitudes.
4. What looks like a problematic aspect ZEO is that the massless on-mass-shell propagators would diverge for wormhole throats. The solution comes from the projection of 4-momenta to  $M^2$ . In the generic the projection is time-like and one avoids the singularity. The study of solutions of the modified Dirac equation [?] and number theoretic vision [?] indeed suggests that the four-momenta are obtained by rotating massless  $M^2$  momenta and their projections to  $M^2$  are in general integer multiples of hyper-complex primes or light-like. The light-like momenta would be treated like in the case of ordinary Feynman diagrams using  $i\epsilon$ -prescription of the propagator and would also give a finite contributions corresponding to integral over physical on mass shell states. This guarantees also the vanishing of the possible IR divergences coming from the summation over different  $M^2$  momenta.

There is a strong temptation to identify - or at least relate - the  $M^2$  momenta labeling the solutions of the modified Dirac equation with the region momenta of twistor approach [?]. The reduction of the region momenta to  $M^2$  momenta could dramatically simplify the twistorial description. It does not seem however plausible that  $\mathcal{N} = 4$  super-symmetric gauge theory could allow the identification of  $M^2$  projections of 4-momenta as region momenta. On the other hand, there is no reason to expect the reduction of TGD certainly to a gauge theory containing QCD as part. For instance, color magnetic flux tubes in many-sheeted space-time are central for understanding jets, quark gluon plasma, hadronization and fragmentation [?] but cannot be deduced from QCD. Note also that the splitting of parton momenta to their  $M^2$  projections and transversal parts is an ad hoc assumption motivated by parton model rather than first principle implication of QCD: in TGD framework this splitting would emerge from first principles.

5. Zero energy ontology strongly suggests that all particles (including photons, gluons, and gravitons) have mass which can be arbitrarily small and can be seen as being due to the fact that particle "eats" Higgs like states giving it the otherwise lacking polarization states. This would mean a generalization of the notion of Higgs particle to a Higgs like particle with spin. It would also mean rearrangement of massless states at wormhole throat level to massive physical states.

The projection of the momenta to  $M^2$  is consistent with this vision. The natural generalization of the gauge condition  $p \cdot \epsilon = 0$  is obtained by replacing  $p$  with the projection of the total momentum of the boson to  $M^2$  and  $\epsilon$  with its polarization so that one has  $p_{||} \cdot \epsilon$ . If the projection to  $M^2$  is light-like, three polarization states are possible in the generic case, so that massivation is required by internal consistency. Note that if intermediate states in the unitary condition were states with light-like  $M^2$ -momentum one could have a problematic situation.

6. A further natural assumption is that the  $M^2$  projections of all momenta assignable to braid strands are parallel. Only the projections of the momenta to the orthogonal complement  $E^2$  of  $M^2$  can be non-parallel and for massive wormhole throats they must be non-parallel. This assumption does not break Lorentz invariance since in the full amplitude one must integrate over possible choices of  $M^2$ . It also interprets the gauge conditions either at the level of braid strands or of partons. Quantum classical correspondence in strong form would actually suggest that quantum 4-momenta should co-incide with the classical ones. The restriction to  $M^2$  projections is however necessary and seems also natural. For instance, for massless extremals only  $M^2$  projection of wave-vector can be well-defined: in transversal degrees of freedom there is a superposition over Fourier components with different transversal wave-vectors. Also the partonic description of hadrons gives for the  $M^2$  projections of the parton momenta a preferred role. It is highly encouraging that this picture emerged first from the modified Dirac equation and purely number theoretic vision based on the identification of  $M^2$  momenta in terms of hyper-complex primes.

The number theoretical approach also suggests a number theoretical quantization of the transversal parts of the momenta [?]: four-momenta would be obtained by rotating massless  $M^2$  momenta

in  $M^4$  in such a manner that the components of the resulting 3-momenta are integer valued. This leads to a classical problem of number theory which is to deduce the number of 3-vectors of fixed length with integer valued components. One encounters the n-dimensional generalization of this problem in the construction of discrete analogs of quantum groups (these "classical" groups are analogous to Bohr orbits) and emerge in quantum arithmetics [?], which is a deformation of ordinary arithmetics characterized by p-adic prime and giving rigorous justification for the notion of canonical identification mapping p-adic numbers to reals.

7. The real beauty of Feynman rules is that they guarantee unitarity automatically. In fact, unitarity reduces to Cutkosky rules which can be formulated in terms of cut obtained by putting certain subset of internal lines on mass shell so that it represents on mass shell state. Cut analyticity implies the usual  $iDisc(T) = TT^\dagger$ . In the recent context the cutting of the internal lines by putting them on-mass-shell requires a generalization.
  - (a) The first guess is that on mass shell property means that  $M^2$  projection for the momenta is light-like. This would mean that also these momenta contribute to the amplitude but the contribution is finite just like in the usual case. In this formulation the real particles would be the massless wormhole throats.
  - (b) Second possibility is that the internal lines on on mass shell states corresponding to massive on mass-shell-particles. This would correspond to the experimental meaning of the unitary conditions if real particles are the massive on mass shell particles. Mathematically it seems possible to pick up from the amplitude the states which correspond to massive on mass shell states but one should understand why the discontinuity should be associated with physical net masses for wormhole contacts or many-particle states formed by them. General connection with unitarity and analyticity might allow to understand this.
8.  $CD$ s are labelled by various moduli and one must integrate over them. Once the tips of the  $CD$  and therefore a preferred  $M^1$  is selected, the choice of angular momentum quantization axis orthogonal to  $M^1$  remains: this choice means fixing  $M^2$ . These choices are parameterized by sphere  $S^2$ . It seems that an integration over different choices of  $M^2$  is needed to achieve Poincare invariance.

### How the propagators are determined?

In accordance with previous sections it will be assumed that the braid are Legendrian braids and therefore completely well-defined. One should assign propagator to the braid. A good guess is that the propagator reduces to a product of three terms.

1. A multi-particle propagator which is a product of collinear massless propagators for braid strands with fermion number  $F = 0, 1 - 1$ . The constraint on the momenta is  $p_i = \lambda_i p$  with  $\sum_i \lambda_i = 1$ . So that the fermionic propagator is  $\frac{1}{\prod_i \lambda_i} p^k \gamma_k$ . If one gas  $p = nP$ , where  $P$  is hyper-complex prime, one must sum over combinations of  $\lambda_i = n_i$  satisfying  $\sum_i n_i = n$ .
2. A unitary  $S$ -matrix for integrable QFT in  $M^2$  in which the velocities of particles assignable to braid strands appear for which fixed by  $R$ -matrix defines the basic 2-vertex representing the process in which a particle passes through another one. For this  $S$ -matrix braids are the basic units. To each crossing appearing in non-planar Feynman diagram one would have an  $R$ -matrix representing the effect of a reconnection the ends of the lines coming to the crossing point. In this manner one could gradually transform the non-planar diagram to a planar diagram. One can ask whether a formulation in terms of a suitable  $R$ -matrix could allow to generalize twistor program to apply in the case of non-planar diagrams.
3. An  $S$ -matrix predicted by topological QFT for a given braid. This  $S$ -matrix should be constructible in terms of Chern-Simons term defining a symplectic QFT.

There are several questions about quantum numbers assignable to the braid strands.



1. Can braid strands be only fermionic or can they also carry purely bosonic quantum numbers corresponding to WCW Hamiltonians and therefore to Hamiltonians of  $\delta M_{\pm}^4 \times CP_2$ ? Nothing is lost if one assumes that both purely bosonic and purely fermionic lines are possible and looks whether this leads to inconsistencies. If virtual fermions correspond to single wormhole throat they can have only time-like  $M^2$ -momenta. If virtual fermions correspond to pairs of wormhole throats with second throat carrying purely bosonic quantum numbers, also fermionic can have space-like net momenta. The interpretation would be in terms of topological condensation. This is however not possible if all strands are fermionic. Situation changes if one identifies physical fermions wormhole throats at the ends of Kähler magnetic flux tube as one indeed does: in this case virtual net momentum can be space-like if the sign of energy is opposite for the ends of the flux tube.
2. Are the 3-momenta associated with the wormholes of wormhole contact parallel so that only the sign of energy could distinguish between them for space-like total momentum and  $M^2$  mass squared would be the same? This assumption simplifies the situation but is not absolutely necessary.
3. What about the momentum components orthogonal to  $M^2$ ? Are they restricted only by the massless mass shell conditions on internal lines and quantization of the  $M^2$  projection of 4-momentum?
4. What braids do elementary particles correspond? The braids assigned to the wormhole throat lines can have arbitrary number  $n$  of strands and for  $n = 1, 2$  the treatment of braiding is almost trivial. A natural assumption is that propagator is simply a product of massless collinear propagators for  $M^2$  projection of momentum [?]. Collinearity means that propagator is product of a multifermion propagator  $\frac{1}{\lambda_i p_k \gamma_k}$ , and multiboson propagator  $\frac{1}{\mu_i p_k \gamma_k}$ ,  $\sum \lambda_i + \sum \mu_i = 1$ . There are also quantization conditions on  $M^2$  projections of momenta from modified Dirac equation implying that multiplies of hyper-complex prime are in question in suitable units. Note however that it is not clear whether purely bosonic strands are present.
5. For ordinary elementary particles with propagators behaving like  $\prod_i \lambda_i^{-1} p^{-n}$ , only  $n \leq 2$  is possible. The topologically really interesting states with more than two braid strands are something else than what we have used to call elementary particles. The proposed interpretation is in terms of anyonic states [?]. One important implication is that  $\mathcal{N} = 1$  SUSY generated by right-handed neutrino or its antineutrino is SUSY for which all members of the multiplet assigned to a wormhole throat have braid number smaller than 3. For  $\mathcal{N} = 2$  SUSY generated by right-handed neutrino and its antiparticle the states containing fermion and neutrino-antineutrino pair have three braid strands and SUSY breaking is expected to be strong.

### Vertices

Conformal invariance raises the hope that vertices can be deduced from super-conformal invariance as  $n$ -point functions. Therefore lines would come from integrable QFT in  $M^2$  and topological braid theory and vertices from conformal field theory: both theories are integrable.

The basic question is how the vertices are defined by the 2-D partonic surfaces at which the ends of lines meet. Finite measurement resolution reduces the lines to braids so that the vertices reduce to the intersection of braid strands with the partonic 2-surface.

1. Conformal invariance is the basic symmetry of quantum TGD. Does this mean that the vertices can be identified as  $n$ -point functions for points of the partonic 2-surface defined by the incoming and outgoing braid strands? How strong constraints can one pose on this conformal field theory? Is this field theory free and fixed by anticommutation relations of induced spinor fields so that correlation function would reduce to product of fermionic two points functions with standard operator in the vertices represented by strand ends. If purely bosonic vertices are present, their correlation functions must result from the functional integral over WCW.
2. For the fermionic fields associated with each incoming braid the anticommutators of fermions and antifermions are trivial just as the usual equal time anticommutation relations. This means that the vertex reduces to sum of products of fermionic correlation functions with arguments belonging to different incoming and outgoing lines. How can one calculate the correlators?

- (a) Should one perform standard second quantization of fermions at light-like 3-surface allowing infinite number of spinor modes, apply a finite measurement resolution to obtain braids, for each partonic 2-surface, and use the full fermion fields to calculate the correlators? In this case braid strands would be discontinuous in vertices. A possible problem might be that the cutoff in spinor modes seems to come from the theory itself: finite measurement resolution is a property of quantum state itself.
  - (b) Could finite measurement resolution allow to approximate the braid strands with continuous ones so that the correlators between strands belonging to different lines are given by anticommutation relations? This would simplify enormously the situation and would conform with the idea of finite measurement resolution and the vision that interaction vertices reduce to braids. This vision is encouraged by the previous considerations and would mean that replication of braid strands analogous to replication of DNA strands can be seen as a fundamental process of Nature. This of course represents an important deviation from the standard picture.
3. Suppose that one accepts the latter option. What can happen in the vertex, where line goes from one braid to another one?
- (a) Can the direction of momentum changed as visual intuition suggests? Is the total braid momentum conservation the only constraint so that the velocities assignable braid strands in each line would be constrained by the total momentum of the line.
  - (b) What kind of operators appear in the vertex? To get some idea about this one can look for the simplest possible vertex, namely FFB vertex which could in fact be the only fundamental vertex as the arguments of [K16] suggest. The propagator of spin one boson decomposes to product of a projection operator to the polarization states divided by  $p^2$  factor. The projection operator sum over products  $\epsilon_i^k \gamma_k$  at both ends where  $\gamma_k$  acts in the spinor space defined by fermions. Also fermion lines have spinor and its conjugate at their ends. This gives rise to  $p^k \gamma_k / p^2$ .  $p^k \gamma_k$  is the analog of the bosonic polarization tensor factorizing into a sum over products of fermionic spinors and their conjugates. This gives the BFF vertex  $\epsilon_i^k \gamma_k$  slashed between the fermionic propagators which are effectively 2-dimensional.
  - (c) Note that if H-chiralities are same at the throats of the wormhole contact, only spin one states are possible. Scalars would be leptoquarks in accordance with general view about lepton and quark number conservation. One particular implication is that Higgs in the standard sense is not possible in TGD framework. It can appear only as a state with a polarization which is in  $CP_2$  direction. In any case, Higgs like states would be eaten by massless state so that all particles would have at least a small mass.

### Functional integral over 3-surfaces

The basic question is how one can functionally integrate over light-like 3-surfaces or space-like 3-surfaces.

1. Does effective 2-dimensionality allow to reduce the functional integration to that over partonic 2-surfaces assigned with space-time sheet inside  $CD$  plus radiative corrections from the hierarchy of sub- $CD$ s?
2. Does finite measurement resolution reduce the functional integral to a ordinary integral over the positions of the end points of braids and could this integral reduce to a sum? Symplectic group of  $\delta M_{\pm}^4 \times CP_2$  basically parametrizes the quantum fluctuating degrees of freedom in WCW. Could finite measurement resolution reduce the symplectic group of  $\delta M_{\pm}^4 \times CP_2$  to a coset space obtained by dividing with symplectic transformations leaving the end points invariant and could the outcome be a discrete group as proposed? Functional integral would reduce to sum.
3. If Kähler action reduces to Chern-Simons-Kähler terms to surface area terms in the proposed manner, the integration over WCW would be very much analogous to a functional integral over string world sheets and the wisdom gained in string models might be of considerable help.

### Summary

What can one conclude from these argument? To my view the situation gives rise to a considerable optimism. I believe that on basis of the proposed picture it should be possible to build a concrete mathematical models for the generalized Feynman graphics and the idea about reduction to generalized braid diagrams having algebraic representations could pose additional powerful constraints on the construction. Braid invariants could also be building bricks of the generalized Feynman diagrams. In particular, the treatment of the non-planarity of Feynman diagrams in terms of  $M^2$  braiding matrix would be something new.

## 12.3 Duality between low energy and high energy descriptions of hadron physics

I found the talk of Matthew Schwartz titled *The Emergence of Jets at the Large Hadron Collider* [?] belonging to the Monday Colloquium Series at Harward. The talk told about the history of the notion of jet and how it is applied at LHC. The notion of jet is something between perturbative and non-perturbative QCD and therefore not a precisely defined concept as one approaches small mass limit for jets.

The talk inspired some questions relating to QCD and hadron physics in general. I am of course not competent to say anything interesting about jet algorithms. Hadronization process is however not well understood in the framework of QCD and uses phenomenological fragmentation functions. The description of jet formation in turn uses phenomenological quark distribution functions. TGD leads to a rather detailed fresh ideas about what quarks, gluons, and hadrons are and stringy and QFT like descriptions emerge as excellent candidates for low and high energy descriptions of hadrons. Low energies are the weakness of QCD and one can well ask whether QCD fails as a physical theory at infrared. Could TGD do better in this respect?

Only a minor fraction of the rest energy of proton is in the form of quarks and gluons. In TGD framework these degrees of freedom would naturally correspond to color magnetic flux tubes carrying color magnetic energy and in proton-proton collisions the color magnetic energy of p-p system in cm system is gigantic. The natural question is therefore about what happens to the "color magnetic bodies" of the colliding protons and of quarks in proton-proton collision.

In the sequel I will develop a simple argument leading to a very concrete duality between two descriptions of hadron reactions manifest at the level of generalized Feynman graphs. The first description is in terms of meson exchanges and applies naturally in long scales. Second one is terms of perturbative QCD applying in short scales. The basic ingredients of the argument are the weak form of electric-magnetic duality [?] and bosonic emergence [?] leading to a rather concrete view about physical particles, generalized Feynman diagrams reducing to generalized braid diagrams in the framework of zero energy ontology (ZEO), and reconnection of Kähler magnetic flux tubes having interpretation in terms of string diagrams providing the mechanism of hadronization. Basically the prediction follows from the dual interpretations of generalized Feynman diagrams either as stringy diagrams (low energies) or as Feynman diagrams (high energies).

It must be emphasized that this duality is something completely new and a simple prediction of the notion of generalized Feynman diagram. The result is exact: no limits (such as large  $N$  limit) are needed.

### 12.3.1 Weak form of electric magnetic duality and bosonic emergence

The weak form of electric magnetic duality allows the identification of quark wormhole throats as Kähler magnetic monopoles with non-vanishing magnetic charges  $Q_m$ . The closely related bosonic emergence [?] effectively eliminates the fundamental BFF vertices from the theory.

1. Elementary fermion corresponds to single wormhole throat with Kähler magnetic charge. In topological condensation a wormhole throat is formed and the working hypothesis is that the second throat is Kähler magnetically neutral. The throats created in topological condensation (formation of topological sum) are always homologically trivial since purely local process is in question.

2. In absence of topological condensation physical leptons correspond to string like objects with opposite Kähler magnetic charges at the ends. Topologically condensed lepton carries also neutralizing weak isospin carried by neutrino pair at the throats of the neutralizing wormhole contact. Wormhole contact itself carries no Kähler magnetic flux. The neutralization scale for  $Q_m$  and weak isospin could be either weak length scale for both fermions and bosons. The alternative option is Compton length quite generally - this even for fermions since it is enough that the weak isospin of weak bosons is neutralized in the weak scale. The alert reader have of course asked whether the weak isospin of fermion must be neutralized at all if this is the case. Whether this really happens is not relevant for the following arguments.
3. Whether a given quark is accompanied by a wormhole contact neutralizing its weak isospin is not quite clear: this need not be the case since the Compton length of weak bosons defines the range of weak interactions. Therefore one can consider the possibility that physical quarks have non-vanishing  $Q_m$  and that only hadrons have  $Q_m = 0$ . Now the Kähler magnetic flux tubes would connect valence quarks. In the case of proton one would have three of them. About 31 year old proposal is that color hyper charge is proportional to Kähler magnetic charge. If so then color confinement would require Kähler magnetic confinement.
4. By bosonic emergence bosons correspond to wormhole contacts or pairs of them. Now wormhole throats have opposite values of  $Q_m$  but the contact itself carries vanishing Kähler magnetic flux. Fermion and anti-fermion are accompanied by neutralizing Kähler magnetic charge at the ends of their flux tubes and neutrino pair at its throats neutralizes the weak charge of the boson.

### 12.3.2 The dual interpretations of generalized Feynman diagrams in terms of hadronic and partonic reaction vertices

Generalized Feynman diagrams are defined in the framework of zero energy ontology (ZEO). Bosonic emergence eliminates fundamental BFF vertices and reduces generalized Feynman diagrams to generalized braid diagrams. This is essential for the dual interpretation of the qgg vertex as a meson emission vertex for hadron. The key idea is following.

1. Topologically condensed hadron - say proton- corresponds to a double sheeted structure: let us label the sheets by letters A and B. Suppose that the sheet A contains wormhole throats of quarks carrying magnetic charges. These wormhole throats are connected by magnetically neutral wormhole contact to sheet B for which wormhole throats carry vanishing magnetic charges.
2. What happens when hadronic quark emits a gluon is easiest to understand by considering first the annihilation of topologically non-condensed charged lepton and antilepton to photon - that is  $L + \bar{L} \rightarrow \gamma$  vertex. Lepton and antilepton are accompanied by flux tubes at different space-time sheets A and B and each has single wormhole throat: one can speak of a pair of topologically condensed deformations of  $CP_2$  type vacuum extremals as a correlate for single wormhole throat. At both ends of the flux tubes deformations of  $CP_2$  type vacuum extremals fuse via topological sum to form a pair of photon wormhole contacts carrying no Kähler magnetic flux. The condition that the resulting structure has the size of weak gauge boson suggests that weak scale defines also the size of leptons and quarks as magnetic flux tubes. Quarks can however carry net Kähler magnetic charge (the ends of flux tube do not have opposite values of Kähler magnetic charge).
3. With some mental gymnastics the annihilation vertex  $L + \bar{L} \rightarrow \gamma$  can be deformed to describe photon emission vertex  $L \rightarrow L + \gamma$ : The negative energy antilepton arrives from future and positive energy lepton from the past and they fuse to a virtual photon in the manner discussed.
4. qgg vertex requires further mental gymnastics but locally nothing is changed since the protonic quark emitting the gluon is connected by a color magnetic flux tube to another protonic quark in the case of incoming proton (and possibly to neutrino carrying wormhole contact with size given by the weak length scale). What happens is therefore essentially the same as above. The protonic quark has become part of gluon at space-time sheet A but has still flux tube connection to proton. Besides this there appears wormhole throat at space-time sheet B carrying quark quantum numbers: this quark would in the usual picture correspond to the quark after gluon

emission and antiquark at the same space-time sheet associated with the gluon. Therefore one has proton with one quark moving away inside gluon at sheet A and a meson like entity at sheet B. The dual interpretation as the emission of meson by proton makes sense. This vertex does not correspond to the stringy vertex  $AB + CD \rightarrow AD + BC$  in which strings touch at some point of the interior and recombine but is something totally new and made possible by many-sheeted space-time. For gauge boson magnetically charge throats are at different space-time sheets, for meson they are at the same space-time sheet and connected by Kähler magnetic flux tube.

5. Obviously the interpretation as an emission of meson like entity makes sense for any hadron like entity for which quark or antiquark emits gluon. This is what the duality of hadronic and parton descriptions would mean. Note that bosonic emergence is absolutely essential element of this duality. In QCD it is not possible to understand this duality at the level of Feynman diagrams.

### 12.3.3 Reconnection of color magnetic flux tubes

The reconnection of color magnetic flux tubes is the key mechanism of hadronization and a slow process as compared to quark gluon emission.

1. Reconnection vertices have interpretation in terms of stringy vertices  $AB + CD \rightarrow AD + BC$  for which interiors of strings serving as representatives of flux tubes touch. The first guess is that reconnection is responsible for the low energy dynamics of hadronic collisions.
2. Reconnection process takes place for both the hadronic color magnetic flux tubes and those of quarks and gluons. For ordinary hadron physics hadrons are characterized by Mersenne prime  $M_{107}$ . For  $M_{89}$  hadron physics reconnection process takes place in much shorter scales for hadronic flux tubes.
3. Each quark is characterized by p-adic length scales: in fact this scale characterizes the length scale of the magnetic bodies of the quark. Therefore Reconnection at the level of the magnetic bodies of quarks takes place in several time and length scales. For top quark the size scale of magnetic body is very small as is also the reconnection time scale. In the case of u and d quarks with mass in MeV range the size scale of the magnetic body would be of the order of electron Compton length. This scale assigned with quark is longer than the size scale of hadrons characterized by  $M_{89}$ . Classically this does not make sense but in quantum theory Uncertainty Principle predicts it from the smallness of the light quark masses as compared to the hadron mass. The large size of the color magnetic body of quark could explain the strange finding about the charge radius of proton [K43].
4. For instance, the formation of quark gluon plasma would involve reconnection process for the magnetic bodies of colliding protons or nuclei in short time scale due to the Lorentz contraction of nuclei in the direction of the collision axis. Quark-gluon plasma would correspond to a situation in which the magnetic fluxes are distributed in such a manner that the system cannot be decomposed to hadrons anymore but acts like a single coherent unit. Therefore quark-gluon plasma in TGD sense does not correspond to the thermal quark-gluon plasma in the naive QCD sense in which there are no long range correlations.

Long range correlations and quantum coherence suggest that the viscosity to entropy ratio is low as indeed observed [K43]. The earlier arguments suggest that the preferred extremals of Kähler action have interpretation as perfect fluid flows [?]. This means at given space-time sheet allows global time coordinate assignable to flow lines of the flow and defined by conserved isometry current defining Beltrami flow. As a matter of fact, all conserved currents are predicted to define Beltrami flows. Classically perfect fluid flow implies that viscosity, which is basically due to a mixing causing the loss of Beltrami property, vanishes. Viscosity would be only due to the finite size of space-time sheets and the radiative corrections describable in terms of fractal hierarchy CDs within CDs. In quantum field theory radiative corrections indeed give rise to the absorptive parts of the scattering amplitudes.

### 12.3.4 Hadron-parton duality and TGD as a "square root" of the statistical QCD description

The main result is that generalized Feynman diagrams have dual interpretations as QCD like diagrams describing partonic reactions and stringy diagrams describing hadronic reactions so that these matrix elements can be taken between either hadronic states or partonic states. This duality is something completely new and distinguishes between QCD and TGD.

I have proposed already earlier this kind of duality but based on group theoretical arguments inspired by what I call  $M^8 - M^4 \times CP_2$  duality [?] and two hypothesis of the old fashioned hadron physics stating that vector currents are conserved and axial currents are partially conserved. This duality suggests that the group  $SO(4) = SU(2)_L \times SU(2)_R$  assignable to weak isospin degrees of freedom takes the role of color group at long length scales and can be identified as isometries of  $E^4 \subset M^8$  just like  $SU(3)$  corresponds to the isometries of  $CP_2$ .

Initial and final states correspond to positive and negative energy parts of zero energy states in ZEO. These can be regarded either partonic or hadronic many particle states. The inner products between *positive* energy parts of partonic and hadronic state basis define the "square roots" of the parton distribution functions for hadrons. The inner products of between *negative* energy parts of hadronic and partonic state basis define the "square roots" of the fragmentations functions to hadrons for partons. M-matrix defining the time-like entanglement coefficients is representable as product of hermitian square root of density matrix and S-matrix is not time reversal invariant and this partially justifies the use of statistical description of partons in QCD framework using distribution functions and fragmentation functions. Decoherence in the sum over quark intermediate states for the hadronic scattering amplitudes is essential for obtaining the standard description.

## 12.4 Quark gluon plasma in TGD framework

I listened an excellent talk by Dam Thanh Son in Harvard Monday seminar series [?]. The title of the talk was *Viscosity, Quark Gluon Plasma, and String Theory*. What the talk represents is a connection between three notions which one would not expect to have much to do with each other.

In the following I shall briefly summarize the basic points of Son's talk which I warmly recommend for anyone wanting to sharpen his or her mental images about quark gluon plasma.

1. Besides this I discuss a TGD variant of AdS/CFT correspondence based on string-parton duality allowing a concrete identification of the process leading to the formation of strongly interacting quark gluon plasma.
2. "Strongly interacting" means that partonic 2-surfaces are connected by Kähler magnetic flux tubes making the many-hadron system single large hadron in the optimal case rather than a gas of uncorrelated partons. This allows a concrete generalization of the formula of kinetic gas theory for the viscosity.
3. One ends up also to a concrete interpretation for the formula for the  $\eta/s$  ratio in terms of TGD variant of Einsteinian gravitation and the analogs of black-hole horizons identified as partonic 2-surfaces. This gravitation is not fictive gravitation in 10-D space but real sub-manifold gravitation in 4-D space-time.
4. It is essential that TGD does not assume gravitational constant as a fundamental constant but as a prediction of theory depending on the p-adic length scale and the typical value of Kähler action for the lines of generalized Feynman graphs. Feeding in the notion of gravitational Planck constant, one finds beautiful interpretation for the lower limit viscosity which is smaller than the one predicted by AdS-CFT correspondence.

### 12.4.1 Some points in Son's talk

Son discusses first the notion of shear viscosity at undergraduate level - as he expresses it. First the standard Wikipedia definition for shear viscosity is discussed in terms of the friction forces created in a system consisting two parallel plates containing liquid between them as one moves a plate with respect to another parallel plate.

Son explains how Maxwell explains the viscosity of gases in terms of kinetic gas theory and entered with a strange result: the estimate  $\eta = \rho v l_{free}$  leads to the conclusion that the viscosity has no pressure dependence: Maxwell himself verified the result experimentally. Imagining that the interaction of gas molecules can be reduced to zero leads to a paradox: the viscosity of the ideal gas is infinite. The solution of the paradox is simple: the theory applies only if  $l_{free}$  is considerably smaller than the size scale of the system, say the distance between the two plates, one of which is moving.

Son discusses the viscosity for some condensed matter systems and finds that the value of viscosity increases very rapidly as a function of temperature: does this mean a rapid increase of  $l_{free}$  with temperature? Son also notices that the viscosity seems to be bounded from below. Son discusses also  $\eta/s$  ratio for the condensed matter systems and finds that it is typically by a factor 10-100 larger than the minimal values  $\hbar/4\pi$  suggested by AdS/CFT correspondence [?].

Son describes gauge-gravity duality briefly. AdS/CFT approach does not allow simple arguments analogous to those used in the kinetic theory of gases.

1. One central formula is Kubo's formula giving viscosity as the low frequency limit for the Fourier component of the component of energy momentum tensor commutation  $[T^{yx}(x, t), T^{yx}(0, 0)]$  as

$$\eta = \frac{1}{2\hbar\omega} \int \langle [T^{yx}(x, t), T^{yx}(0, 0)] d^4x \rangle_{\omega \rightarrow 0}$$

for  $\mathcal{N} = 4$  SUSY defined in  $M^4$ . Now this theory is  $\mathcal{N} = 4$  SUSY so that there is no hope about simple interpretation. Note that the formula is consistent with the dimensions of viscosity which is  $M/L^3$ . I confess that I do not understand the origin of the formula at the level details. Green-Kubo relations [?] are certainly the starting point having very general justification as an outcome of fluctuation theorem [?] allowing understood relatively easily in Gaussian model for thermodynamics. Since energy momentum tensor serves as a source of gravitons and is the basic observable in hydrodynamics, it is clear that this formula is consistent with gauge theory-gravity correspondence.  $\omega \rightarrow 0$  limit means that the low energy sector of the gauge theory is in question so that the perturbative approach fails.

2. In TGD framework the analog of this formula need not be useful. If it apply it should apply to partonic 2-surfaces and  $AdS_5 \times S_5$  should be replaced with space-time surface. The energy momentum tensor should be the energy momentum tensor of partonic 2-surface fixed to a high degree by conformal invariance. One should sum over all partonic 2-surfaces. The partonic 2-surfaces would correspond to both ends of a braid strands at the opposite light-like boundaries of  $CD$ . The integral at the level of the partonic 2-surface is now only 2-dimensional and the dimension of  $\eta$  would be  $1\hbar/L$  in this case. In the kinetic gas theory formula this follows from the fact that mass density has now dimension  $m/L$  rather than  $m/L^3$ . The summation over the partonic 2-surfaces could correspond in many particle system integration. I tend to see this kind of approach as too formal.

AdS/CFT duality [?] reduces the calculation of the viscosity to that for the graviton absorption cross section for  $AdS_5 \times S_5$  black hole when the N-stack of branes is replaced with a brane black hole in  $AdS_5 \times S^5$ . Viscosity is reduced essentially to the area of the black-hole multiplied by Planck constant. Since the dimension of 4-D viscosity is  $\hbar/L^3$ , the area must be measured using Planck length squared  $G$  as a unit. Is viscosity the number density multiplied by this dimensionless quantity? I must admit that I do not really understand this result.

### 12.4.2 What is known about quark-gluon plasma?

Son summarizes some facts about quark-gluon plasma and they are included in the following summary about what little I know.

1. The first surprise was produced by RHIC observing that the viscosity to entropy density ratio for quark gluon plasma is near  $\hbar/4\pi$  -its lower limit as predicted by AdS/CFT duality. The low value of  $\eta/s$  ratio does not mean that the viscosity would be low. As a matter fact it is gigantic - of order  $10^{14}$  centipoise and therefore 14 orders of magnitude higher than for water! Glass is the the only condensed matter system possessing a higher viscosity in the list of Son. The challenge

is to understand why the ratio is so small in terms of QCD or perhaps a theory transcending the limitations of QCD at low energies. From Kubo's formula it is clear that the low energy limit of QCD is indeed needed to understand the viscosity.

2. In the nuclear collisions allowing to deduce information about viscosity the nuclei do not collide quite head on. The time of collision is short due to the Lorentz contraction. The projection of the collision region in the plane orthogonal to the collision axes is almond shaped so that rotational symmetry is lost and implies that viscous forces enters the game. If the system reaches thermal equilibrium, the notion of pressure make senses. The force caused by the pressure gradient is stronger in transversal than longitudinal direction of almond since the almond in transversal direction is shorter than in longitudinal direction. That hets in this direction are more energetic supports the view that pressure is a well-defined concept. On the other hand, the viscous force in the longitudinal direction is large and tends to compensate this effect. This effect gives hopes of measuring the viscosity.
3.  $\eta/s$  ratio seems to be near  $\hbar/4\pi$  for the quark-gluon plasma formed in both heavy ion collisions and in proton-proton collisions although the energy scales are quite different. This is not expected on basis of the strong temperature dependence of viscosity in condensed matter systems.
4. On basis of RHIC results [?, ?] for heavy ion collisions and the LHC results for proton-proton collisions, which unexpectedly demonstrated similar plasma behavior for proton-proton collisions one can conclude that quark gluon plasma is a strongly interacting system. The temperature assignable to the quark-gluon plasma possibly formed in proton-proton collisions is of course must higher than at RHIC. Recently also the results from lead-lead collisions at LHC have emerged: the temperature of the plasma should be about 500 MeV as compared to the temperature 250 MeV at RHIC. In this case AdS/CFT duality gives hopes for describing the non-perturbative aspects of the system. This is just a hope: AdS/CFT correspondence requires many assumptions which might not hold true for the quark-gluon plasma and there are preliminary indications [?], which do not support AdS/CFT duality [?, ?]. The experiments favor a model in which the situation is described based old-fashioned Lund model [?] treating gluons as strings. This description is a a simplified version of the description provided by TGD.

### 12.4.3 Gauge-gravity duality in TGD framework

AdS/CFT duality is one variant of a more general gauge-gravity duality. Gauge-gravity in turn involves several variants depending on whether one assumes that Einstein's curvature scalar provides a good approximation to the description of gravitational sector. This requires that higher spin excitations of string like objects are very heavy and can be neglected. It might be that since low energy limit is in question as is clear from Kubo's formula, the use of Einstein's action makes sense very generally.

#### String-gauge theory duality in TGD framework

If I were enemy of string theory and follower of the usual habits of my species, I would be very skeptic from the beginning. There are however no rational reasons to be hostile since string worlds sheets at 4-D space time sheets appear also in TGD and there very strong reasons to expect duality between QFT like descriptions and stringy description. I indeed discussed in previous section how this duality can be understood directly at the level of generalized Feynman diagrams as a kind of combinatorial identity. There is no need to introduce strings in  $AdS_5 \times S^5$  as in the usual AdS/CFT approach and  $N_c \rightarrow \infty$  implying the vanishing of the contribution of non-planar Feynman diagrams is not needed.

#### The reduction to Einsteinian gravity need not take place

String-gauge theory duality need not reduce QCD to Einsteinian gravity allowing modeling in terms of curvature scalar.

1. In TGD framework the physics for small deformations of vacuum extremals - whose number is gigantic (any Lagrangian sub-manifold of  $CP_2$  defines a vacuum sector of the theory) - would



be governed by Einstein's equations. The value of gravitational constant is however dynamical and a little dimensional analysis argument suggests that the gravitational constant satisfies [?]

$$G_{eff}(p) = L^2(k)exp(-2S_K) ,$$

where  $L_p$  is p-adic length scales associated with p-adic prime  $p \simeq 2^k$  and  $S_K$  is the Kähler action for a deformation of  $CP_2$  type vacuum extremal in general smaller than for full  $CP_2$ .

2. Ordinary gravitational constant would correspond to  $p = M_{127} = 2^{127} - 1$  assignable to electron:  $M_{127}$  is the largest Mersenne prime which does not define a completely super-astrophysical p-adic length scale. The value of  $S_K$  would be almost maximal and induce an enormous reduction of the value of  $G$ .
3. For hadron physics  $S_K$  should not be large and in reasonable approximation this would give  $G_{eff} \simeq \hbar L^2(k = 107)$ . The deformations of  $CP_2$  type vacuum extremals, whose  $M^4$  projections are random light-like curves. are assignable to elementary particles such as gluons. In the case of hadrons these projections are expected to be short and so that the exponent is expected to be near unity. One might hope that these contributions dominate in the calculation of viscosity so that Einstein's picture indeed works.
4. In the case of hadron physics there are no strong reason to expect a general reduction to Einsteinian gravity. Higher spin states at the hadronic Regge trajectories are important and hadron physics does not reduce to gravitational theory involving the exchanges of only spin two strong gravitons.

This requires additional assumption which the lecture of Son tried to clarify. The assumption is that the coordinate of  $AdS_5$  orthogonal to its boundary  $M^4$  representing 4-D Minkowski space represents scaling of the physical system and that the interactions in the bulk are ultra-local with respect to this coordinate. Only systems with same scale size interact. This assumption looks very strange to me but has analog in quantum TGD. Personally I would take this argument with a big grain of salt.

### Reduction to hydrodynamics

The  $AdS_5/CFT$  duality in the strong form reduces the dynamics at the boundary of  $AdS_5$  to Einstein's gravity in the interior of AdS and the  $N$ -stack of 3-branes corresponds to brane black-hole in  $AdS_5 \times S_5$ . There are also good reasons to expect that Einstein's gravity in turn reduces to hydrodynamics.

The field equations of TGD are conservation laws for isometry currents and Kähler currents plus their super counterparts. Also in hydrodynamics the basic equations reduce to conservation laws. The structural equations of hydrodynamics correspond to the identification of gauge fields and metrics as induced structures.

The reduction to 4-D hydrodynamics in much stronger sense is suggestive since a large class of preferred extremals of Kähler action have interpretation as hydrodynamic flows for which flow lines define coordinate curves of a global coordinate [?]. Beltrami flows are in question. For instance, a magnetic field for which Lorentz force vanishes is a good example of 3-D Beltrami flow. There are good arguments in favore of the existence of a unique preferred coordinate system defined in terms of light-like local direction and its dual direction plus two orthogonal local polarization directions.

### Could AdS/CFT duality have some interpretation in TGD framework?

In TGD framework the duality between strings and particles replacing AdS/CFT duality means the replacement of  $AdS \times S_5$  with space-time surface represented as surface in  $M^4 \times CP_2$ . Furthermore  $M^4$  is replaced with partonic 2-surfaces the super-conformal invariance of  $\mathcal{N} = 4$  SUSY in  $M^4$  is replaces with 2-D super-conformal invariance. Therefore the attempts to build analogies with AdS/CFT duality type description might be waste of time. The temptation for the search of analogies is however too high.

In the case of AdS/CFT duality for Minkowski space that coordinate of  $AdS_5$  orthogonal to its  $M^4$  boundary is interpreted as a scale parameter for the system and also has interpretation as a scalar field in  $M^4$ . Could this scaling degree have some sensible interpretation in TGD framework. What about the N-stack of 3-branes representing a copy of  $M^4$  identified as the boundary of  $AdS_5$ ?

1. In TGD framework the only physically sensible interpretation would be in terms of the hierarchy of Planck constants [K25]. The quantum size of the particle scales like  $\hbar$  and is therefore integer valued. This suggests that the continuous  $AdS_5$  coordinate orthogonal to  $M^4$  could be replaced with the integer labeling the effective values of Planck constant and hence the local coverings of  $M^4 \times CP_2$  providing a convenient description for the fact that -due to the enormous vacuum degeneracy of Kähler action- the time derivatives of the imbedding space coordinates are multi-valued functions of the canonical momentum densities. Different coverings that they effectively correspond to different sectors of the effective imbedding space which can be seen as a finite covering of  $M^4 \times CP_2$ . Only the particles with the same value of Planck constant can appear in the same vertex of generalized Feynman diagrams and this is nothing but the strange assumption made to guarantee the locality of AdS dynamics.
2. Same collapse of the sheets of the covering actually applies in the directions transversal to space-like and light-like 3-surfaces so that both of them represent branchings and the total number of branches in the interior is  $n_1 n_2$ .
3. One must assume that the sheets of the covering collapse at the partonic 2-surfaces and perhaps also at the string world sheets. This strange orbifold property brings strongly in mind the stack of N-branes which collapse to single 3 brane however remembering its N-stack property: for instance, a dynamical gauge group  $SU(N) \times U(1)$  describing finite measurement resolution emerges. The loss of the infinitely thin stack property in the interior guarantees that N-stack property is not forgotten. I have indeed proposed that similar emergence of gauge groups allowing to represent finite measurement resolution in terms of gauge symmetry emerges also in TGD framework.
4. The effective dimensionless coupling in the perturbative expansion is  $g^2 N / \hbar$  and for large  $N$  limit the series does not converge. If  $N$  corresponds to the number of colors for dynamically generated gauge group labeling colors, the substitution  $\hbar = N \hbar_0$  however implies that the expansion parameter does not change at all so that the limit would be different from the usual  $N \rightarrow \infty$  limit used to derive AdS/CFT duality.

An integrable QFT in  $M^2$  identified as hyper-complex plane in number theoretic vision is necessary for interpreting generalized Feynman diagrams as generalized braids. One can of course ask whether one would have super-conformal QFT in  $M^2$  and whether  $AdS_3$  could be replaced with its discrete version with normal coordinate identified as the integer characterizing the value of Planck constant. To me this approach seems highly artificial although it might make sense formally.

One can of course ask whether  $M^4 \times CP_2$  could have some deep connection with  $AdS_5 \times S_5$ . This might be the case:  $CP_2$  is obtained from  $S^5$  by identifying all points of its geodesic circles and  $M^4$  is obtained from  $AdS_5$  by identifying all points of radial geodesics in the the scaling direction.

### Do black-holes in $AdS_5 \times S_5$ have TGD counterpart?

The black-holes in  $AdS_5 \times S_5$  have very natural counterparts as regions of the space-time surfaces with Euclidian signature of the induced metric. These regions represent generalized Feynman diagrams. By holography one could restrict the consideration also to the partonic 2-surfaces at the ends of  $CDs$  and if string world sheets and partonic 2-surfaces are dual to string world sheets coming as Minkowskian and Euclidian variants.

Black-holes in TGD framework would have Euclidian metric and their presence is absolutely essential for reducing the functional integral to a genuine integral. Otherwise one would have the analog of path integral with the exponential of Kähler action defining a mere phase factor.

The entropy area law for the black-holes generalizes to p-adic thermodynamics and the p-adic mass squared value for the particle predicted by p-adic thermodynamics is essentially the p-adic entropy: both are mapped to the real sector by canonical identification. Also the black hole entropy is proportional to mass squared.

The gigantic value of the gravitational Planck constants brings in additional interpretational issues to be discussed later.

### 12.4.4 TGD view about strongly interacting quark gluon plasma

The magnetic flux tubes/strings connecting quarks make the QCD plasma strongly interacting in TGD framework.

1. In the hadronic phase the network formed by these flux tubes decomposes to sub-networks assignable to the colliding protons. In the final state the sub-networks are associated with the outgoing hadrons. In the collision a network is formed in which the flux tubes can connect larger number of quarks and one obtains much longer cycles in the network as in the initial and final states. This can be regarded as a defining property of strongly interaction quark gluon plasma. In quantum world one obtains a quantum superposition over networks with different connectedness structures. The quark-gluon plasma is not ideal in quantum sense.
2. The presence of plasma blob predicts the reduction of jet production cross section. Typically a pair of jets is produced. If this occurs in deep interior of the plasma, the jets cannot escape the plasma. If this occurs near the surface of the plasma, the other jet escapes. This predicts reduction of the jet production cross section.
3. The decomposition to connected flux tube networks could explain why the experimentally detected ratio for jet production cross section nucleonic total scattering cross section is larger than the predicted one: the flux tube network would consist of disconnected network with a considerably property and for these the jet production cross section would not be so dramatically reduced by the fact that the other member of the never gets out from the plasma blob.

In TGD context the basic process leading to the formation of the quark-gluon plasma is reconnection for the flux tubes describable in terms of string diagrams  $AB - CD \rightarrow AD + BC$ . In the case of ordinary quark gluon plasma the density is so high that nucleons overlap geometrically and lead to the formation of the plasma. In TGD framework the magnetic bodies of quarks having size scale characterized by quark Compton length would overlap. The Compton lengths for light quarks with masses estimated to be of order 10 MeV are much larger than the size scale of nucleon and even that of nucleus. What does this mean? Does the reconnection process take place in several scales so that the notion of quark gluon plasma would be fractal? Note that in the recent proton-proton collisions the energy per nucleon is about 200 GeV. Does quark gluon plasma at LHC involve the fusion of the flux tubes of the color magnetic bodies of nucleons? Do these form connected structures.

In the kinetic gas theory viscous force in the system of parallel plates is caused by the diffusion of particles moving with velocity  $u$  which depends on the coordinate orthogonal to the parallel plates. One can imagine a fictive plane through which the particles diffuse in both directions and the forces is due to that fact that the diffusing particles have different velocities differing by  $\Delta u_x = \partial_y u_x l_{free}$  on the average. In the case of magnetic flux tubes the presence of magnetic flux tube connection the two quarks at the opposite sides of the fictive plane leads to a stretching of the flux tube and this costs energy. This favors the diffusion of either quark to the other side of the fictive plane and this induces the transformed of momentum parallel to the plates. Similar argument could apply also in the case of the ordinary liquids if one allows also electric flux tubes.

#### Jets and flux tubes structures

Magnetic flux tube provide also a more concrete vision about the notion of jet.

1. Jets are collinear particle like objects producing collinear hadrons. The precise definition of jets is however problematic in QCD framework. TGD suggests a more precise definition of jets as connected sub-networks formed by partons and by definition having vanishing total Kähler magnetic charge. Jet would be kind of super-hadron which decays to ordinary nearly collinear hadrons as the flux tube structure decomposes by reconnection process to smaller connected flux tube structures during hadronization.
2. Factorization theorems of QCD discussed in very clear manner by Ian Stewart [?] state that the dynamics at widely different scales separate for each other so that quantum mechanical interference effects can be neglected and probabilistic description applies in long length scales and quantal effects reduce to non-perturbative ones. The initial and final stages of the collision

process proceed slowly as compared to those describable in terms of perturbative QCD. Hence one can apply partonic distribution functions and fragmentation functions. These functions should have a description in terms of reconnection process.

3. The presence of different scales means in TGD framework to p-adic length scale hierarchy assignable to flux tubes gives a much more precise articulation for the notion of scale. No quantum interference effects can take place between different p-adic scales if the real amplitudes are obtained from p-adic valued amplitudes by the generalization of canonical identification discussed in [?]. For instance, in p-adic mass calculations the values p-adic mass squared are summed for for given p-adic prime before the mapping to real mass squared by canonical identification. For different values of p-adic primes the additive quantities are the real masses.

### Possible generalizations of Maxwell's formula formula for the viscosity

Could one understand the viscosity if one assumes that the reconnection of the magnetic flux tubes replaces the collisions of particles in the kinetic theory of gases? One can imagine several alternatives.

1. The free path of the particle appears in the kinetic gas theory estimate  $\eta = nmvl_{free}$  for the viscosity. If this decomposition makes sense now,  $l_{free}$  should correspond to the size scale of the magnetic body of light quark and if its size corresponds to the Compton length of the quark one would have  $l_{free} \sim \hbar/m$ . If one assumes  $s \sim n$  one has  $\eta = nv\hbar$ . For  $v = c = 1$  this would give  $\eta/s \sim \hbar/4\pi$  apart from numerical constant.

If  $\hbar$  indeed appears in  $l_{free}$  and the magnetic flux tube size scales as  $\hbar$ , the minimum value for the viscosity would scale as  $\hbar$ . It is difficult to say whether one should regard this as good or bad prediction from the point of view of the hierarchy of Planck constants. Over-optimistically one might ask whether large  $\hbar$  could explain the non-minimal values of  $\eta/s$  in terms of large  $\hbar$ . Note however that the minimal value of  $\eta/s$  can be smaller than  $\hbar/4\pi$  in some systems.

2. One could consider the replacement of the Compton length  $r_C = \hbar/m_q$  with the classical charge radius of quark defined as  $r_{cl} = g^2/m_q$ . In this case the size scale of the magnetic body would not depend on  $\hbar$ . For color coupling strength  $\alpha_s = .1$  one would have  $r_{cl}/r_C = 1.26$  so that experimental data do not allow to distinguish between these options. At low energies  $r_{cl}$  would grow and therefore also the viscosity since the lengths of flux tubes would get longer.
3. One can also purely gravitational view about single partonic 2-surface. Taking the notion of gravitational Planck constant seriously [K65], one can consider the replacement of  $v$  with the velocity parameter  $v_0$  (dimensionless in the units used) appearing in the gravitational Planck constant  $\hbar_{gr} = G_{eff}M^2/v_0$  and the identification  $l_{free} = 2r_S = 4G_{eff}M$ : the diameter of the black hole identified as partonic 2-surface. Note that Schwarchild radius would be equal to Planck length. Entropy would be given  $4\pi(2G_{eff}M)^2/\hbar G_{eff}$  multiplied by the number  $N = \hbar/\hbar_0$  of the sheets of the covering. This would give the lower bound  $\hbar_0 v_0/4\pi$  which is smaller than that provided by AdS/CFT approach. This option looks the most attractive one.

For all three options one would expect that  $\eta/s$  ratio is same for the quark-gluon plasma formed in heavy ion collisions and in proton-proton collisions. The critical reader probably wonders what one means with the entropy in the strongly interacting system. Magnetic flux tubes could be seen as space-time correlates for entanglement. Can one regard the entropy as a single particle observable? Can one assign to each partonic 2-surfaces an entanglement entropy or does the entropy characterizes pairs of parton surfaces being analogous to potential energy rather than kinetic energy?

### The formula for viscosity based on black-hole analogy

The following argument is a longer version of very concise argument of previous section suggesting that the notion of gravitational Planck constant allows to generalize the formula of the kinetic gas theory to give viscosity in the more general case. Partonic 2-surface is regarded as an analog the horizon of a black-hole. The interior of the black-hole corresponds to a region with an Euclidian signature of the induced metric. The space-time metric in question could be either the induced metric or the effective metric defined by the modified gamma matrices defined by Kähler action [?]. Induced metric seems to be the correct option since it is non-trivial for vacuum extremals of Kähler action but also

the effective metric probably has physical meaning. Only the data at horizon having by definition degenerate four-metric appear in the formula for  $\eta/s$ .

1. The notion of gravitational Planck constant for space-time sheets carrying self gravitational interaction is given by  $\hbar_{gr} = kGM^2/v_0$ , where  $v_0 < c = 1$  has dimensions of velocity. The interpretation is in terms of Planck constant assignable with flux tubes mediating self gravitation and carrying dark energy identified as magnetic energy. The enormous value of Planck constant means cosmological quantum coherence explaining why this energy density is very slow varying and can be therefore described in terms of cosmological constant in good approximation. Negative "pressure" corresponds to magnetic tension.
2. Suppose that  $v_0$  is identified as the velocity appearing as typical velocity in the kinetic theory estimate  $\eta = Mnv l_{free}$ . Suppose that  $l_{free}$  corresponds to Schwarzschild radius for the effective gravitational constant  $l_{free} = 2r_s = 4G_{eff}M$ . Another possible identification is as the scaled up Planck length  $l_{free} = l_P = \sqrt{\hbar G} = GM/\sqrt{v_0}$ . Suppose that the formula for black hole entropy holds true and gives for the entropy of single particle the expression  $S = 4\pi(2G_{eff}M)^2/\hbar G_{eff}$ . This gives  $\eta/s = \hbar v_0/4\pi$  for the first option (note that  $v_0$  dependence disappears. One obtains  $\eta/s = \hbar/16\pi\sqrt{v_0}$  for the second option so that  $v_0$  dependence remains.
3. The objection is that black hole entropy goes to zero as  $\hbar$  increases. One can indeed argue that the  $S = 4\pi(2G_{eff}M)^2/\hbar G_{eff}$  gives only the contribution of single sheet in the  $N = \hbar\bar{a}r/\hbar_0$  fold covering of  $M^4 \times CP_2$  so that one must multiply this entropy with  $N$ . This would give

$$\frac{\eta}{S} = \frac{\hbar_0}{4\pi} \times \frac{v_0}{c} .$$

The minimum viscosity can be smaller than  $\hbar_0/4\pi$  and the essential parameter is the velocity parameter  $v_0 = v_0 < c = 1$ . This is true also in AdS-CFT correspondence.

This argument suggests that the Einsteinian dark gravity with gravitational gauge coupling having as parameters p-adic length scale and the typical Kähler action of deformed  $CP_2$  type vacuum extremal could allow to understand viscosity in terms of string-QFT duality in the idealization that the situation reduces to a black-hole physics with partonic 2-surfaces taking the role of black holes. This proposal might make even in the case of condensed matter if one gives up the assumption that the basic objects are more analogous to stars than black-holes.

### 12.4.5 AdS/CFT is not favored by LHC

As already noticed that the first experimental results from LHC [?] do not favor AdS/CFT duality but are qualitatively consistent with TGD view about gauge-gravity duality. Because of the importance of the results I add a version of my blog posting [?] about these results.

Sabine Hossenfelder told in BackReaction blog about the first results from lead-lead ion collisions at LHC, which have caused a cold shower for AdS/CFT enthusiasts. Or summarizing it in the words of Sabine Hossenfelder:

*As the saying goes, a picture speaks a thousand words, but since links and image sources have a tendency to deteriorate over time, let me spell it out for you: The AdS/CFT scaling does not agree with the data at all.*

#### The results

The basic message is that AdS/CFT fails to explain the heavy ion collision data about jets at LHC. The model should be able to predict how partons lose their momentum in quark gluon plasma assumed to be formed by the colliding heavy nuclei. The situation is of course not simple. Plasma corresponds to low energy QCD and strong coupling and is characterized by temperature. Therefore it could allow description in terms of AdS/CFT duality allowing to treat strong coupling phase. Quarks themselves have a high transversal momentum and perturbative QCD applies to them. One has to understand how plasma affects the behavior of partons. This boils to simple question: What is the energy loss of the jet in plasma before it hadronizes.

The prediction of AdS/CFT approach is a scaling law for the energy loss  $E \propto L^3 T$ , where  $L$  is the length that parton travels through the plasma and the temperature  $T$  is about 500 MeV is the temperatures of the plasma (at RHIC it was about 350 MeV). The figure in the posting of Sabine Hossenfelder [?] compares the prediction for the ratio  $R_{AA}$  of the predicted nuclear cross section for jets in lead-lead collisions to those in proton-proton collisions to experimental data normalized in such a manner that if the nucleus behaved like a collection of independent nucleons the ratio would be equal to one.

That the prediction for  $R_{AA}$  is too small is not so bad a problem: the real problem is that the curve has quite different shape than the curve representing the experimental data. In the real situation  $R_{AA}$  as a function of the average transversal momentum  $p_T$  of the jets approaches faster to the "nucleus as a collection of independent nucleons" situation than predicted by AdS/CFT approach. Both perturbative QCD and AdS/CFT based model fail badly: their predictions do not actually differ much.

An imaginative theoretician can of course invent a lot of excuses. It might be that the number  $N_c = 3$  of quark colors is not large enough so that strong coupling expansion and AdS/CFT fails. Supersymmetry and conformal invariance actually fail. Maybe the plasma temperature is too high (higher than at RHIC where the observed low viscosity of gluon plasma motivated AdS/CFT approach). The presence of both weak coupling regime (high energy partons) and strong coupling regime (the plasma) might have not been treated correctly. One could also defend AdS/CFT by saying that maybe one should take into account higher stringy corrections for strings moving in 10 dimensional  $AdS_5 \times S^5$ . Why not branes? Why not black holes? And so on....

### Could the space-time be 4-dimensional after all?

What is remarkable that a model called "Yet another Jet Energy-loss Model" (YaJEM) based on the simple old Lund model [?] treating gluons as strings in 4-D space-time works best! Also the parameters derived for RHIC do not need large re-adjustment at LHC.

4-D space-time has been out of fashion for decades and now every-one well-informed theoretician talks about emergent space-time. Don't ask what this means. Despite my attempts to understand I (and very probably any-one) do not have a slightest idea. What I know is that string world sheets are 2-dimensional and the only hope to get 4-D space-time is by this magic phenomenon of emergence. In other worlds, 3-brane is what is wanted and it should emerge "non-perturbatively" (do not ask what *this* means!).

Since there are no stringy authorities nearby, I however dare to raise a heretic question. Could it be that string like objects in 4-D space-time are indeed the natural description? Could strings, branes, blackholes, etc. in 10-D space-time be completely un-necessary stuff needed to keep several generations of misled theoreticians busy? Why not to start by trying to build abstraction from something which works? Why not start from Lund model or hadronic string model and generalize it?

This is what TGD indeed was when it emerged some day in October year 1977: a generalization of the hadronic string model by replacing string world sheets with space-time sheets. Another motivation for TGD was as a solution to the energy problem of GRT. In this framework the notion of (color) magnetic flux tubes emerges naturally and magnetic flux tubes are one of the basic structures of the theory now applied in all length scales. The improved mathematical understanding of the theory has led to notions like effective 2-dimensionality and stringy world sheets and partonic 2-surfaces at 4-D space-time surface of  $M^4 \times CP_2$  as basic structures of the theory.

### What TGD can say about the situation?

In TGD framework a naive interpretation for LHC results would be that the colliding nuclei do not form a complete plasma and this non-ideality becomes stronger as  $p_T$  increases. As if for higher  $p_T$  the parton would traverse several blobs rather than only single big one and situation would be between an ideal plasma and to that in which nucleons form collections of independent nucleons. Could quantum superposition of states with each of them representing a collection of some number of plasma blobs consisting of several nucleons be in question. Single plasma blob would correspond to the ideal situation. This picture would conform with the vision about color magnetic flux tubes as a source of long range correlations implying that what is called quark-gluon plasma is in the ideal case like single very large hadron and thus a diametrical opposite for parton gas.

In TGD framework where hadrons themselves correspond to space-time sheets, this interpretation is suggestive. The increase of the temperature of the plasma corresponds to the reduction of  $\alpha_s$  suggesting that with at  $T=500$  GeV at LHC the plasma is more "blobby" than at  $T=350$  GeV at RHIC. This would conform with the fact that at lower temperature at RHIC the AdS/CFT model works better. Note however that at RHIC the model parameters for AdS/CFT are very different from those at LHC [?]: not a good sign at all.

I have also discussed the TGD based explanation of RHIC results for heavy ion collisions and the unexpected behavior of quark-gluon plasma in proton-proton (rather than heavy ion) collisions at LHC [?].

## 12.5 Proposal for a twistorial description of generalized Feynman graphs

Listening of the lectures of Nima Arkani-Hamed is always an inspiring experience and so also at this time [?]. The first recorded lectures was mostly about the basic "philosophical" ideas behind the approach and the second lecture continued discussion of the key points about twistor kinematics which I should already have in my backbone but do not. The lectures stimulated again the feeling that the generalized Feynman diagrammatics has all the needed elements to allow a twistorial description. It should be possible to interpret the diagrams as the analogs of twistorial diagrams.

A couple of new ideas emerged as a result of concentrate effort to build bridge to the twistorial approach.

1. Generalized Feynman diagrams involve only massless states at wormhole throats so that twistorial description makes sense for the kinematical variables. One should identify the counterparts of the lines and vertices of the twistor diagrams constructed from planar polygons and counterparts of the region momenta.
2.  $M^2 \subset M^4$  appears as a central element of TGD based Feynman diagrammatics and  $M^2$  projection of the four momentum appears in propagator and also in the modified Dirac equation. I realized that p-adic mass calculations must give the thermal expectation value of the  $M^2$  mass squared. Since the throats are massless this means that the transversal momentum squared equal to  $CP_2$  contribution plus conformal weight contribution to mass squared.
3. It is not too surprising that a very beautiful interpretation in terms of the analogs of twistorial diagrams becomes possible. The idea is to interpret wormhole contacts as pairs of lines of twistor diagrams carrying on mass shell momenta. In this manner triangles with truncated apexes with double line representing the wormhole throats become the basic objects in generalized Feynman diagrammatics. The somewhat mysterious region momenta of twistor approach correspond to momentum exchanges at the wormhole contacts defining the vertices. A reasonable expectation is that the Yangian invariants used to construct the amplitudes of  $\mathcal{N} = 4$  SUSY can be used as basic building bricks also now.
4. Renormalization group is not understood in the usual twistor approach and p-adic considerations and quantization of the size of causal diamond ( $CD$ ) suggests that the old proposal about discretization of coupling constant evolution to p-adic length scale evolution makes sense. A very concrete realization of the evolution indeed suggest itself and would mean the replacement of each triangle with the quantum superposition of amplitudes associated with triangles with smaller size scale and contained with the original triangle characterized by the size scale of corresponding  $CD$  containing it. In fact the incoming and outgoing particles of of vertex could be located at the light-like boundaries of  $CD$ .
5. The approach should be also number theoretically universal and this suggests that the amplitudes should be expressible in terms of quantum rationals and rational functions having quantum rationals as coefficients of powers of the arguments. Quantum rationals are characterized by p-adic prime  $p$  and p-adic momentum with mass squared interpreted as p-adic integer appears in the propagator. This means that the propagator proportional to  $1/P^2$  is proportional to  $1/p$  when mass squared is divisible by  $p$ , which means that one has pole like contribution. The real

counterpart of propagator in canonical identification is proportional to  $p$ . This would select the all  $CD$  characterized by  $n$  divisible by  $p$  as analogs of poles.

### 12.5.1 What generalized Feynman diagrams could be?

Let us first list briefly what these generalized Feynman diagrams emerge and what they should be.

1. Zero energy ontology and the closely related notion of causal diamond ( $CD$ ) are absolutely essential for the whole approach.  $U$ -matrix between zero energy states is unitary but does not correspond to the  $S$ -matrix. Rather,  $U$ -matrix has as its orthonormal rows  $M$ -matrices which are "complex" square roots of density matrices representable as a product of a Hermitian square root of density matrix and unitary and universal  $S$ -matrix commuting with it so that the Lie algebra of these Hermitian matrices acts as symmetries of  $S$ -matrix. One can allow all  $M$ -matrices obtained by allowing integer powers of  $S$ -matrix and obtains the analog of Kac-Moody algebra. The powers of  $S$  correspond to  $CD$  with temporal distance between its tips coming as integer multiple of  $CP_2$  size. The goal is to construct  $M$ -matrices and these could be non-unitary because of the presence of the hermitian square root of density matrix.
2. If it is assumed that  $M$ -matrix elements can be constructed in terms of generalized Feynman diagrams. What generalized Feynman diagrams strictly speaking are is left open. The basic properties of generalized Feynman diagrams - in particular the property that only massless on mass shell states but with both signs of energy appear- however suggest strongly that they are much more like twistor diagrams and that twistorial method used to sum up Feynman diagrams apply.

#### The lines of the generalized Feynman diagrams

Generalized Feynman diagrams are constructed using solely diagrams containing on mass shell massless particles in both external and internal lines. Massless-ness could mean also massless-ness in  $M^4 \times CP_2$  sense, and p-adic thermodynamics indeed suggests that this is true in some sense.

1. For massless-ness in  $M^4 \times CP_2$  sense the standard twistor description should fail for massive excitations having mass scale of order  $10^4$  Planck masses. At external lines massless states form massive on mass shell particles. In the following this possible difficulty will be neglected. Stringy picture suggests that this problem cannot be fatal.
2. Second possibility is that massless states form composites which in the case of fermions have the mass spectrum determined by  $CP_2$  Dirac operator and that that physical states correspond to states of super-conformal representations with ground states weight determined by the sum of vacuum conformal weight and the contribution of  $CP_2$  mass squared. In this case, one would have massless-ness in  $M^4$  sense but composite would be massless in  $M^4 \times CP_2$  sense. In this case twistorial description would work.
3. The third and the most attractive option is based on the fact that it is  $M^2$  momentum that appears in the propagators. The picture behind p-adic mass calculations is string picture inspired by hadronic string model and in hadron physics one can assign  $M^2$  to longitudinal parts of the parton momenta.

One can therefore consider the possibility that  $M^2$  momentum square obeys p-adic thermodynamics.  $M^2$  momentum appears also in the solutions of the modified Dirac equation so that this identification looks physically very natural.  $M^2$  momentum characterizes naturally also massless extremals (topological light rays) and is in this case massless. Therefore throats could be massless but  $M^2$  momentum identifiable as the physical momentum would be predicted by p-adic thermodynamics and its p-adic norm could correspond to the scale of  $CD$ .

Mathematically this option is certainly the most attractive one and it might be also physically acceptable since integration over moduli characterizing  $M^2$  is performed to get the full amplitude so that there is no breaking of Poincare invariance.

There are also other complications.



1. Massless wormhole throats carry magnetic charges bind to form magnetically neutral composite particles consisting of wormholes connected by magnetic flux tubes. The wormhole throat at the other end of the wormhole carries opposite magnetic charge and neutrino pair canceling the electro-weak isospin of the physical particle. This complication is completely analogous to the appearance of the color magnetic flux tubes in TGD description of hadrons and will be neglected for a moment.
2. Free fermions correspond to single wormhole throats and the ground state is massless for them. Topologically condensed fermions carry mass and the ground states has developed mass by p-adic thermodynamics. Above considerations suggests that the correct interpretation of p-adic thermal mass squared is as  $M^2$  mass squared and that the free fermions are still massless! Bosons are always pairs of wormhole throats. It is convenient to denote bosons and topologically condensed fermions by a pair of parallel lines very close to each other and free fermion by single line.
3. Each wormhole throat carries a braid and braid strands are carriers of four-momentum.
  - (a) The four momenta are parallel and only the  $M^2$  projection of the momentum appears in the fermionic propagator. To obtain Lorentz invariance one must integrate over boosts of  $M^2$  and this corresponds to integrating over the moduli space of causal diamond ( $CD$ ) inside which the generalized Feynman diagrams reside.
  - (b) Each line gives rise to a propagator. The sign of the energy for the wormhole throat can be negative so that one obtains also space-like momentum exchanges.
  - (c) It is not quite clear whether one can allow also purely bosonic braid strands. The dependence of the over all propagator factor on longitudinal momentum is  $1/p^{2n}$  so that throats carrying 1 or 2 fermionic strands (or single purely bosonic strand) are in preferred position and braid strand numbers larger than 2 give rise to something different than ordinary elementary particle. It is probably not an accident that quantum phases  $q = \exp(i2\pi/n)$  give rise to bosonic and fermionic statistics for  $n = 1, 2$  and to braid statistics for  $n > 2$ . States with  $n \geq 3$  are expected to be anyonic. This also reduces the large super symmetry generated by fermionic oscillator operators at the partonic 2-surfaces effectively to  $\mathcal{N} = 1$  SUSY.

In the following It will be assume that all braid strands appearing in the lines are massless and have parallel four-momenta and that  $M^2$  momentum squared is given by p-adic thermodynamics and actually mass squared vanishes. It is also assumed that  $M^2$  momenta of the throats of the wormhole throats are parallel in accordance with the classical idea that wormhole throats move in parallel. It is convenient to denote graphically the wormhole throat by a pair of parallel lines very close to each other.

### Vertices

The following proposal for vertices neglects the fact that physical elementary particles are constructed from wormhole throat pairs connected by magnetic flux tubes. It is however easy to generalizes the proposal to that case.

1. Conservation of momentum holds in each vertex but only for the total momentum assignable to the wormhole contact rather than for each throat. The latter condition would force all partons to have parallel massless four-momenta and the S-matrix would be more or less trivial. Conservation of four-momentum, the massless on mass shell conditions for 4-momenta of wormhole throats and on mass shell conditions  $M^2$  momentum squared given by stringy mass squared spectrum are extremely powerful and it is quite possible that one obtains in a given resolution defined by the largest and smallest causal diamonds finite number of diagrams.
2. I have already earlier developed arguments strongly suggesting that that only three-vertices are fundamental [K16]. The three vertex at the level of wormhole throats means gluing of the ends of the generalized line along 2-D partonic two surface defining their ends so that diagrams are generalization of Feynman diagrams rather than 4-D generalizations of string diagrams so that a

generalization of a trouser diagram does not describe particle decay). The vertex can be BFF or BBB vertex or a variant of this kind of vertex obtained by replacing some B:s and F:s with their super-partners obtained by adding right handed neutrino or antineutrino on the wormhole throat carrying fermion number. Massless on mass shell conditions hold true for wormhole throats in internal lines but they are not on mass shell as a massive particles like external lines.

3. What happens in the vertex is momentum exchange between different wormhole throats regarded as braids with strands carrying parallel momenta. This momentum exchange in general corresponds to a non-vanishing mass squared and can be graphically described as a line connecting two vertices of a triangle defined by the particles emerging into the vertex. To each vertex of the triangle either massless fermion line or pair of lines describing topologically condensed fermion or boson enters. The lines connecting the vertices of the triangle carry the analogs of region momenta [?], which are in general massive but the differences of two adjacent region momenta are massless. The outcome is nothing but the analog of the twistor diagram. 3- vertices are fundamental and one would obtain only 3-gons and the Feynman graph would be a collection of 3-gons such that from each line emerges an internal or external line.
4. A more detailed graphical description utilizes double lines. For FFB vertices with free fermions one would have 4-gon containing a pair of vertices very near to each other corresponding to the outgoing boson wormhole described by double line. This is obtained by truncating the bosonic vertex of 3-gon and attaching bosonic double line to it. For topologically condensed fermions and BBB vertex one would have 6-gon obtained by truncating all apices of a 3-gon.

Some comments about the diagrammatics is in order.

1. On mass shell conditions and momentum conservation conditions are extremely powerful so that one has excellent reasons to expect that in a given resolution defined by the largest and smallest  $CD$  involves the number of contributing diagrams is finite.
2. The resulting diagrams are very much like twistor diagrams in  $\mathcal{N} = 4$  D=4 SYM for which also three-vertex and its conjugate are the fundamental building bricks from which tree amplitudes are constructed: from tree amplitudes one in turn obtains loop amplitudes by using the recursion formulas. Since all momenta are massless, one can indeed use twistor formalism. For topologically condensed fermions one just forms all possible diagrams consisting of 6-gons for which the truncated apices are connected by double lines and takes care that  $n$  lines are taken to be incoming lines.
3. The lines can cross, and this corresponds to the analog of non-planar diagram. I have proposed a knot-theoretic description of this situation based on the generalized braiding matrix appearing in integrable QFTs defined in  $M^2$ . By using a representation for the braiding operation which can be used to eliminate the crossings of the lines one could transform all diagrams to planar diagrams for which one could apply existing construction recipe.
4. The basic conjecture is that the basic building bricks are Yangian invariants. Not only for the conformal group of  $M^4$  but also for the super-conformal algebra should have an extension to Yangian. This Yangian should be related to the symmetry algebra generated by the M-matrices and analogous to Kac-Moody algebra. For this Yangian points as vertices of the momentum polygon are replaced with partonic 2-surfaces.

### Generalization of the diagrammatics to apply to the physical particles

The previous discussion has neglected the fact that the physical particles are not wormhole contacts. Topologically condensed elementary fermions and bosons indeed correspond to magnetic flux pairs at different space-time sheets with wormhole contacts at the ends. How could one describe this situation in terms of the generalization Feynman diagrams?

The natural guess is that one just puts two copies of diagrams above each other so that the triangles are replaced with small cylinders with cross section given by the triangle and the edges of this triangular cylinder representing magnetic flux tubes. It is natural to allow momentum exchanges also at the other end of the cylinder: for ordinary elementary particle these ends carry only neutrino pairs

so that the contribution to interactions is screening at small momenta. Also momentum exchanges long the direction of the cylinder should be allowed and would correspond to the non-perturbative low energy degrees of freedom in the case of hadrons. This momentum exchange assignable to flux tube would be between the truncated triangle rather than separately along the three vertical edges of the triangular cylinder.

### 12.5.2 Number theoretical universality and quantum arithmetics

The approach should be also number theoretically universal meaning that amplitudes should make sense also in p-adic number fields or perhaps in adelic sense in the tensor product of p-adic numbers fields. Quantum arithmetics is characterized by p-adic prime and canonical identification mapping p-adic amplitudes to real amplitudes is expected to make number theoretical universality possible.

This is achieved if the amplitudes should be expressible in terms of quantum rationals and rational functions having quantum rationals as coefficients of powers of the arguments. This would be achieved by simply mapping ordinary rationals to quantum rationals if they appear as coefficients of polynomials appearing in rational functions.

Quantum rationals are characterized by p-adic prime  $p$  and p-adic momentum with mass squared interpreted as p-adic integer appears in the propagator. If  $M^2$  mass squared is proportional to this p-adic prime  $p$ , propagator behaves as  $1/P^2 \propto 1/p$ , which means that one has pole like contribution for these on mass shell longitudinal masses. p-Adic mass calculations indeed give mass squared proportional to  $p$ . The real counterpart of propagator in canonical identification is proportional to  $p$ . This would select the all  $CD$  characterized by  $n$  divisible by  $p$  as analogs of propagator poles. Note that the infrared singularity is moved and the largest p-adic prime appearing as divisor of integer characterizing the largest  $CD$  indeed serves as a physical IR cutoff.

It would seem that one must allow different p-adic primes in the generalized Feynman diagram since physical particles are in general characterized by different p-adic primes. This would require the analog of tensor product for different quantum rationals analogous to adeles. These numbers would be mapped to real (or complex) numbers by canonical identification.

#### How to get only finite number of diagrams in a given IR and UV resolution?

In gauge theory one obtains infinite number of diagrams. In zero energy ontology the overall important additional constraint comes from on mass shell conditions at internal lines and external lines and from the requirement that the  $M^2$  momentum squared is quantized for super-conformal representation in terms of stringy mass squared spectrum.

This condition alone does not however imply that the number of diagrams is finite. If forward scattering diagram is non-vanishing also scattering without on mass shell massive conditions on final state lines is possible. One can construct diagrams representing a repeated  $n \rightarrow n$  scattering and combining these amplitudes with non-forward scattering amplitude one obtains infinite number of scattering diagrams with fixed initial and final states. Number theoretic universality however requires that the number of the contributing diagrams must be finite unless some analytic miracles happens.

The finite number of diagrams could be achieved if one gives for the vision about  $CD$ s within  $CD$ s a more concrete metric meaning. In spirit of Uncertainty Principle, the size scale of the  $CD$  defined by the temporal distance between its tips could correspond to the inverse of the momentum scale defined as its inverse. A further condition would be that the sub- $CD$ s and their Lorentz boosts are indeed within the  $CD$  and do not overlap. Obviously the number of diagrams representing repeated  $n - n$  scattering forward scattering is finite if these assumptions are made. This would also suggest a scale hierarchy in powers of 2 for  $CD$ s: the reason is that given  $CD$  with scale  $T = nT(CP_2)$  can contain two non-overlapping sub- $CD$ s with the same rest frame only if sub- $CD$  has size scale smaller than  $nT_{CP_2}/2$ . This applies also to the Lorentz boosts of the sub- $CD$ s.

Amplitudes would be constructed by labeling the  $CD$ s by integer  $n$  defining its size scale. p-Adicity suggests that the factorization of  $n$  to primes must be important and if  $n = p$  condition holds true, a new resonant like contribution appears corresponding to p-adic diagrams involving propagator.

Should one allow all  $M^2$  momenta in the loops in all scales or should one restrict the  $M^2$  momenta to have a particular mass squared scale determined somehow by the size of  $CD$  involved? If this kind of constraint is posed it must be posed in mathematically elegant manner and it is not clear how to this.

Is this kind of constraint really necessary? Quantum arithmetics for the length scale characterized by p-adic prime  $p$  would make  $M^2$  mass squared values divisible by  $p$  to almost poles of the propagators, and this might be enough to effectively select the particular  $p$  and corresponding momentum scale and  $CD$  scale. Consider only the Mersenne prime  $M_{127} = 2^{127} - 1$  as a concrete example.

### How to realize the number theoretic universality?

One should be able to realized the p-adicity in some elegant manner. One must certainly allow different p-adic primes in the same diagram and here adelic structure seems unavoidable as tensor product of amplitudes in different p-adic number fields or rather - their quantum arithmetic counterparts characterized by a preferred prime  $p$  and mapped to reals by the substitution  $p \rightarrow 1/p$ . What does this demand?

1. One must be able to glue amplitudes in different p-adic number fields together so that the lines in some case must have dual interpretation as lines of two p-adic number fields. It also seems that one must be able to assign p-adic prime and quantum arithmetics characterized by a given prime  $p$  to a given propagator line. This prime is probably not arbitrarily and it will be found that it should not be larger than the largest prime dividing  $n$  characterizing the  $CD$  considered.
2. Should one assign p-adic prime to a given vertex?
  - (a) Suppose first that bare 3-vertices reduce to algebraic numbers containing no rational factors. This would guarantee that they are same in both real and p-adic sense. Propagators would be however quantum rationals and depend on  $p$  and have almost pole when the integer valued mass squared is proportional to  $p$ .
  - (b) The radiative corrections to the vertex would involve propagators and this suggests that they bring in the dependence on  $p$  giving rise to p-adic coupling constant evolution for the real counterparts of the amplitudes obtained by canonical identification.
    - i. Should also vertices obey p-adic quantum arithmetics for some  $p$ ? What about a vertex in which particles characterized by different p-adic primes enter? Which prime defines the vertex or should the vertex somehow be multi-p p-adic? It seems that vertex cannot contain any prime as such although it could depend on incoming p-adic primes in algebraic or transcendental manner.
    - ii. Could the radiative corrections sum up to algebraic number depending on the incoming p-adic primes? Or are the corrections transcendental as ordinary perturbation theory suggests and involve powers of  $\pi$  and logarithm of mass squared and basically logarithms of some primes requiring infinite-dimensional transcendental extension of p-adic numbers? If radiative corrections depend only on the logarithms of these primes p-adic coupling constant evolution would be obtained. The requirement that radiative vertex corrections vanish does not look physically plausible.
  - (c) Only sub- $CD$ s corresponding to integers  $m < n$  would be possible as sub- $CD$ . A geometrically attractive possibility is that  $CD$  characterized by integer  $n$  allows only propagator lines which correspond to prime factors of integers not larger than the largest prime dividing  $n$  in their quantum arithmetics. Bare vertices in turn could contain only primes larger than the maximal prime dividing  $n$ . This would simplify the situation considerably- This could give rise to coupling constant evolution even in the case that the radiative corrections are vanishing since the rational factors possibly present in vertices would drop away as  $n$  would increase.
  - (d) Integers  $n = 2^k$  give rise to an objection. They would allow only 2-adic propagators and vertices containing no powers of 2. For  $p = 2$  the quantum arithmetics reduces to ordinary arithmetics and ordinary rationals correspond to  $p = 2$  apart from the fact that powers of 2 mapped to their inverses in the canonical identification. This is not a problem and might relate to the fact that primes near powers of 2 are physically preferred. Indeed, the  $CD$ s with  $n = 2^k$  would be in a unique position number theoretically. This would conform with the original - and as such wrong - hypothesis that only these time scales are possible for  $CD$ s. The preferred role of powers of two supports also p-adic length scale hypothesis.

These observations give rather strong clues concerning the construction of the amplitudes. Consider a  $CD$  with time scale characterized by integer  $n$ .

1. For given  $CD$  all sub- $CD$ s with  $m < n$  are allowed and all p-adicities corresponding to the primes appearing as prime factors of given  $m$  are possible.  $m = 2^k$  are in a preferred position since  $p = 2$  quantum rationals not containing 2 reduce to ordinary rationals.
2. The geometric condition that sub- $CD$ s and their boosts remain inside  $CD$  and do not overlap together with momentum conservation and on-mass-shell conditions on internal lines implies that only a finite number of generalized Feynman diagrams are possible for given  $CD$ . This is essential for number theoretical universality. To each sub- $CD$  one must assign its moduli spaces including its not-too-large boosts. Also the planes  $M^2$  associated with sub- $CD$ s should be regarded as independent and one should integrate over their moduli.
3. The construction of amplitudes with a given resolution would be a process involving a finite number of steps. The notion of renormalization group evolution suggests a generalization as a change of the amplitude induced by adding  $CD$ s with size smaller than smallest  $CD$ s and their boosts in a given resolution.
4. It is not clear whether increase of the upper length scale interpreted as IR cutoff makes sense in the similar manner although physical intuition would encourage this expectation.

### 12.5.3 How to understand renormalization flow in twistor context?

In twistor context the notion of mass renormalization is not straightforward since everything is massless. In TGD framework p-adic mass scale hypothesis suggests a solution to the problem.

1. At the fundamental level all elementary particles are massless and only their composites forming physical particles are massive.
2.  $M^2$  mass squared is given by p-adic mass calculations and should correspond to the mass squared of the physical particle. There are contributions from magnetic flux tubes and in the case of baryons this contribution dominates.
3. p-Adic physics discretizes coupling constant flow. Once the p-adic length scale of the particle is fixed its  $M^2$  momentum squared is fixed and massless takes care of the rest.

Consider now how renormalization flow would emerge in this picture. At the level of generalized Feynman diagrams the change of the IR (UV) resolution scale means that the maximal size of the  $CD$ s involve increases (the minimal size of the sides decreases).

Concerning the question what  $CD$  scales should be allowed, the situation is not completely clear.

1. The most general assumption allows integer multiples of  $CP_2$  scale and would guarantee that the products of hermitian matrices and powers of S-matrix commuting with them define Kac-Moody type algebra assignable to M-matrices. If one uses in renormalization group evolution equation  $CD$ s corresponding to integer multiples of  $CP_2$  length scale, the equation would become a difference equation for integer valued variable.
2. p-Adicity would suggest that the scales of  $CD$ s come as prime multiples of  $CP_2$  scale. The proposed realization of p-adicity indeed puts  $CD$ s characterized by p-adic primes  $p$  in a special position since they correspond to the emergence of a vertex corresponding to p-adic prime  $p$  which depends on  $p$  in the sense that the radiative corrections to 3-vertex can give it a dependence on  $\log(p)$ . This requires infinite-D transcendental extension of p-adic numbers.

As far as coupling constant evolution in strict sense is considered, a natural looking choice is evolution of vertices as a function of p-adic primes of the particles arriving to the vertex since radiative corrections are expected to depend on their logarithms.

3. p-Adic length scale hypothesis would allow only p-adic length scales near powers of two. There are excellent reasons to expect that these scales are selected by a kind of evolutionary process favoring those scales for  $CD$ s for which particles are maximally stable. The fact that quantum

arithmetics for  $p = 2$  reduces to ordinary arithmetics when quantum integers do not contain 2 raises with size scales coming as powers of 2 in a special position and also supports p-adic length scale hypothesis.

Renormalization group equations are based on studying what happens in an infinitesimal reduction of UV resolution scale would mean. Now the change cannot be infinitesimal but must correspond to a change in the scale of  $CD$  by one unit defined by  $CP_2$  size scale.

1. The decrease of UV cutoff means addition of new details represented as bare 3-vertices represented by truncated triangle having size below the earlier length scale resolution. The addition can be done inside the original  $CD$  and inside any sub- $CD$  would be in question taking care that the details remain inside  $CD$ . The hope is that this addition of details allows a recursive definition. Typically addition would involve attaching two sub- $CD$ s to propagator line or two propagator lines and connecting them with propagator. The vertex in question would correspond to a p-adic prime dividing the integer characterizing the sub- $CD$ s. Also the increase of the shortest length scale makes sense and means just the deletion of the corresponding sub- $CD$ s. Note that also the positions of sub- $CD$ s inside  $CD$  manner since the number of allowed boosts depends on the position. This would mean an additional complication.
2. The increase of IR cutoff length means that the size of the largest  $CD$  increases. The physical interpretation would be in terms of the time scale in which one observes the process. If this time scale is too long, the process is not visible. For instances, the study of strong interactions between quarks requires short enough scale for  $CD$ . At long scales one only observes hadrons and in even longer scales atomic nuclei and atoms.
3. One could also allow the UV scale to depend on the particle. This scale should correspond to the p-adic mass scales assignable to the stable particle. In hadron physics this kind of renormalization is standard operation.

#### 12.5.4 Comparison with $\mathcal{N} = 4$ SYM

The ultimate hope is to formulate all these ideas in precise formulas. This goal is still far away but one can make trials. Let us first compare the above proposal to the formalism in  $\mathcal{N} = 4$  SYM.

1. In the construction of twistorial amplitudes the 4-D loop integrals are interpreted as residue integrals in complexified momentum space and reduces to residues around the poles. This is analogous to using "on mass shell states" defined by this poles. In TGD framework the situation is different since one explicitly assigns massless on-mass-shell fermions to braid strands and allows the sign of the energy to be both positive and negative.
2. Twistor formalism and description of momentum and helicity in terms of the twistor  $(\lambda, \mu)$  certainly makes sense for any spin. The well-known complications relate to the necessity to use complex twistors for  $M^4$  signature: this would correspond to complexified space-time or momentum space. Also region momenta and associated momentum twistors are the TGD counterparts so that the basic building bricks for defining the analogs of twistorial amplitudes exist.

An important special feature is that the gauge potential is replaced with its  $\mathcal{N} = 4$  super version.

1. This has some non-generic implications. In particular gluon helicity -1 is obtained from 1 ground state by "adding" four spartners with helicity +1/2 each. This interpretation of the two helicities of a massless particle is not possible in  $\mathcal{N} < 4$  theories nor in TGD and the question is whether this is something deep or not remains open.
2. In TGD framework it is natural to interpret all fermion modes associated with partonic 2-surface (and corresponding light-like 3-surfaces) as generators of super-symmetry and fermions are fundamental objects instead of helicity +1 gauge bosons. Right-handed neutrino has special role since it has no electroweak or color interactions and generates SUSY for which breaking is smallest.

3. The  $\mathcal{N} = 2$  SUSY generated by right-handed neutrino and antineutrino is broken since the propagator for states containing three fermion braid strands at the same wormhole throat behaves like  $1/p^3$ : this is already an anyon-like state. The least broken SUSY is  $\mathcal{N} = 1$  SUSY with spartners of fermions being spin zero states. The proposal is that one could construct scattering amplitudes by using a generalize chiral super-field associated with  $\mathcal{N}$  equal to the number of spinor modes acting on ground state that has vanishing helicity. For  $\mathcal{N} = 4$  it has helicity +1 [?]. This would suggest that the analogs of twistorial amplitudes exist and could even have very similar formulas in terms of twistor variables.
4. The all-loop integrand [?] for scattering amplitudes in planar  $\mathcal{N} = 4$  SYM relies of BCFW formula allowing to sew two n-particle three amplitudes together using single analog of propagator line christened as BCFW bridge. Denote by  $Y_{n,k,l}$  n-particle amplitudes with  $k$  positive helicity gluons and  $l$  loops. One can glue  $Y_{n_L,k_L,l_L}$  and  $Y_{n_R,k_R,l_R}$  by using BCFW bridge and "entangled" removal of two external lines  $Y_{n_L+n_R,k=k_L+k_R+1,l=l_L+l_R-1}$  amplitude to get  $Y_{n=n_L+n_R-2,k=k_L+k_R+1,l=l_L+l_R}$  amplitude recursively by starting from just two amplitudes defining the 3-vertices. The procedure involves only residue integral over the  $Gl(k,n)$  for a quantity which is Yangian invariant. The question is whether one could apply this procedure by replacing  $\mathcal{N} = 4$  SUSY with SUSY in TGD sense and generalizing the fundamental three particle vertices appropriately by requiring that they are Yangian invariants?
5. One can also make good guesses for the BCFW bridge and entangled removal. By looking the structure of the amplitudes obtained by the procedure from 3-amplitudes, one learns that one obtains tree diagrams for which some external lines are connected to give loop. The simplest situation would be that BCFW bridge corresponds to  $M^2$  fermion propagator for a given braid strand and entangled removal corresponds to a short cut of two external lines to internal loop line. One would have just ordinary Feynman graphs but vertices connected with Yangian invariants (not that there is sum over loop corrections). It should be easy to kill this conjecture.

### 12.5.5 Very Special Relativity as justification for the special role of $M^2$

The preferred role of  $M^2$  in the construction of generalized Feynman diagrams could be used as a criticism. Poincare invariance is lost. The first answer to the criticism is that one integrates of the choices of  $M^2$  so that Poincare invariance is lost. One can however defend this assumption also from different view point. Actually Glashow and Cohen did this in their Very Special Relativity proposal [?!] While scanning old files, I found an old text about Very Special Relativity of Glashow and Cohen, and realized that it relates very closely to the special role of  $M^2$  in the construction of generalized Feynman diagrams. There is article Very Special Relativity and TGD [?] at my homepage but for some reason the text has disappeared from the book that contained it. I add the article more or less as such here.

Configuration space ("world of classical worlds", WCW) decomposes into a union of sub-configuration spaces associated with future and past light-cones and these in turn decompose to sub-sub-configuration spaces characterized by selection of quantization axes of spin and color quantum numbers. At this level Poincare and even Lorentz group are reduced. The possibility that this kind of breaking might be directly relevant for physics is discussed below.

One might think that Poincare symmetry is something thoroughly understood but the Very Special Relativity [?] proposed by nobelist Sheldon Glashow and Andrew Cohen suggests that this might belief might be wrong. Glashow and Cohen propose that instead of Poincare group, call it  $P$ , some subgroup of  $P$  might be physically more relevant than the whole  $P$ . To not lose four-momentum one must assume that this group is obtained as a semi-direct product of some subgroup of Lorentz group with translations. The smallest subgroup, call it  $L_2$ , is a 2-dimensional Abelian group generated by  $K_x + J_y$  and  $K_y - J_x$ . Here  $K$  refers to Lorentz boosts and  $J$  to rotations. This group leaves invariant light-like momentum in  $z$  direction. By adding  $J_z$  acting in  $L_2$  like rotations in plane, one obtains  $L_3$ , the maximal subgroup leaving invariant light-like momentum in  $z$  direction. By adding also  $K_z$  one obtains the scalings of light-like momentum or equivalently, the isotropy group  $L_4$  of a light-like ray.

The reasons why Glashow and Cohen regard these groups so interesting are following.

1. All kinematical tests of Lorentz invariance are consistent with the reduction of Lorentz invariance to these symmetries.

2. The representations of group  $L_3$  are one-dimensional in both *massive* and massless case (the latter is familiar from massless representations of Poincare group where particle states are characterized by helicity). The mass is invariant only under the smaller group. This might allow to have left-handed massive neutrinos as well as massive fermions with spin dependent mass.
3. The requirement of CP invariance extends all these reduced symmetry groups to the full Poincare group. The observed very small breaking of CP symmetry might correlate with a small breaking of Lorentz symmetry. Matter antimatter asymmetry might relate to the reduced Lorentz invariance.

The idea is highly interesting from TGD point of view. The groups  $L_3$  and  $L_4$  indeed play a very prominent role in TGD.

1. The full Lorentz invariance is obtained in TGD only at the level of the entire configuration space which is union over sub-configuration spaces associated with future and past light-cones (space-time sheets inside future or past light-cone) [?, ?]. These sub-configuration spaces decompose further into a union of sub-sub-configuration spaces for which a choice of quantization axes of spin reflects itself at the level of generalized geometry of the imbedding space (quantum classical correspondence requires that the choice of quantization axes has imbedding space and space-time correlates) [K82, K25]. The construction of the geometry for these sub-worlds of classical worlds reduces to light-cone boundary so that the little group  $L_3$  leaving a given point of light-cone boundary invariant is in a special role in TGD framework.
2. The selection of a preferred light-like momentum direction at light-cone boundary corresponds to the selection of quantization axis for angular momentum playing a key role in TGD view about hierarchy of Planck constants associated with a hierarchy of Jones inclusions implying a breaking of Lorentz invariance induced by the selection of quantization axis [K82, K25]. The number theoretic vision about quantum TGD implies a selection of two preferred axes corresponding to time-like and space-like direction corresponding to real and preferred imaginary unit for hyperoctonions [K72, ?]. In both cases  $L_4$  emerges naturally.
3. The TGD based identification of Kac-Moody symmetries as local isometries of the imbedding space acting on 3-D light-like orbits of partonic 2-surfaces involves a selection of a preferred light-like direction and thus the selection of  $L_4$ .
4. Also the so called massless extremals representing a precisely targeted propagation of patterns of classical gauge fields with light velocity along typically cylindrical tubes without a change in the shape involve  $L_4$ . A very general solution ansatz to classical field equations involves a local decomposition of  $M^4$  to longitudinal and transversal spaces and selection of a light-like direction [K9].
5. The parton model of hadrons assumes a preferred longitudinal direction of momentum and mass squared decomposes naturally to longitudinal and transversal mass squared. Also p-adic mass calculations rely heavily on this picture and thermodynamics mass squared might be regarded as a longitudinal mass squared [K45]. In TGD framework right handed covariantly constant neutrino generates a super-symmetry in  $CP_2$  degrees of freedom and it might be better to regard left-handed neutrino mass as a longitudinal mass.

This list justifies my own hunch that Glashow and Cohen might have discovered something very important.



# Mathematics

- [A1] Gaussian Mersenne. <http://primes.utm.edu/glossary/xpage/GaussianMersenne.html>.
- [A2] Z. I. Borevich and I. R. Shafarevich. *Number Theory*. Academic Press, 1966.
- [A3] Eisenhart. *Riemannian Geometry*. Princeton University Press, 1964.
- [A4] C. N. Pope G. W. Gibbons.  $CP_2$  as gravitational instanton. *Comm. Math. Phys.*, 55, 1977.
- [A5] W. Hawking, S. and N. Pope, C. Generalized Spin Structures in Quantum Gravity. *Phys. Lett.*, (1), 1978.
- [A6] S. Helgason. *Differential Geometry and Symmetric Spaces*. Academic Press, New York, 1962.
- [A7] C. Itzykson and J-B. Zuber. *Quantum Field Theory*, volume 549. Mc Graw-Hill, New York, 1980.
- [A8] J. Milnor. *Topology form Differential Point of View*. The University Press of Virginia, Virginia, 1965.
- [A9] D. S. Moak. The q-analogue of the Laguerre polynomials. *J. Math. Anal. Appl.*, 81, 1981.
- [A10] N. Pope, C. Eigenfunctions and  $Spin^c$  Structures on  $CP_2$ , 1980.
- [A11] B. Shipman. The geometry of momentum mappings on generalized flag manifolds, connections with a dynamical system, quantum mechanics and the dance of honeybee. <http://math.cornell.edu/~oliver/Shipman.gif>, 1998.
- [A12] M. Spivak. *Differential Geometry I,II,III,IV*. Publish or Perish, Boston, 1970.
- [A13] J. Hanson T. Eguchi, B. Gilkey. *Phys. Rep.*, 66:1980, 1980.
- [A14] R. Thom. *Commentarii Math. Helvet.*, 28, 1954.
- [A15] Wallace. *Differential Topology*. W. A. Benjamin, New York, 1968.
- [A16] E. C. Zeeman. *Catastrophe Theory*. Addison-Wessley Publishing Company, 1977.



# Theoretical Physics

- [B1] J. Björken and S. Drell. *Relativistic Quantum Fields*. Mc Graw-Hill, New York, 1965.
- [B2] K. Huang. *Quarks, Leptons & Gauge Fields*. World Scientific, 1982.
- [B3] R. Kiehn. Electromagnetic waves in vacuum with torsion and spin. <http://www22.pair.com/csdc/pdf/helical6.pdf>.
- [B4] G. Parisi. *Field Theory, Disorder and Simulations*. World Scientific, 1992.
- [B5] A. Zee. *The Unity of Forces in the Universe*. World Science Press, Singapore, 1982.



# Particle and Nuclear Physics

- [C1] Giant Dipole Resonance: What is Known About? <http://cdfc.sinp.msu.ru/publications/lshkhnv-ELI03.pdf>.
- [C2] Abragam A. *The principles of nuclear magnetism*. Clarendon Press, Oxford, 1961.
- [C3] C. Rolfs et al. First hints on a change of the  $^{22}\text{Na}$  beta decay half-life in the metal Pd. *Eur. Phys. J. A*, 28, 2006.
- [C4] C. Rolfs et al. High-Z electron screening, the cases  $^{50}\text{V}(\text{p},\text{n})^{50}$ . *Eur. Phys. J. A*, 28, 2006.
- [C5] G. Tertuchny et al. Microscopic description of the pygmy and giant electric dipole resonances in stable Ca isotopes. <http://arxiv.org/abs/nucl-th/0603/0603051>, 2006.
- [C6] S. E. Shnoll et al. Realization of discrete states during fluctuations in macroscopic processes. *Uspekhi Fisicheskikh Nauk*, 41(10):1025–1035, 1998.
- [C7] V. M. Lobashev et al. In *Neutrino 96*, Singapore, 1996. World Scientific.
- [C8] K. Langanke H. J. Assenbaum and C. Rolfs. *Z. Phys. A*, 327, 1987.
- [C9] A. D. Krisch. The spin of proton. *Scientific American*, May 1979.
- [C10] M. T. Ressel and M. S. Turner. *Astrophys.*, 14, 1990.
- [C11] C. Rolfs and W. S. Rodney. *Cauldrons in the Cosmos*. University of Chicago Press, Chicago, 1988.



# Books related to TGD

- [K1] M. Pitkänen. 1983.
- [K2] M. Pitkänen. Is it Possible to Understand Coupling Constant Evolution at Space-Time Level? In *Towards M-Matrix*. Onlinebook. [http://tgdtheory.com/public\\_html/tgdquant/tgdquant.html#rgflow](http://tgdtheory.com/public_html/tgdquant/tgdquant.html#rgflow), 2006.
- [K3] M. Pitkänen. About Strange Effects Related to Rotating Magnetic Systems . In *TGD and Fringe Physics*. Onlinebook. [http://tgdtheory.com/public\\_html/freenergy/freenergy.html#Faraday](http://tgdtheory.com/public_html/freenergy/freenergy.html#Faraday), 2006.
- [K4] M. Pitkänen. About the New Physics Behind Qualia. In *Quantum Hardware of Living Matter*. Onlinebook. [http://tgdtheory.com/public\\_html/bioware/bioware.html#newphys](http://tgdtheory.com/public_html/bioware/bioware.html#newphys), 2006.
- [K5] M. Pitkänen. An Overview about Quantum TGD: Part I. In *Topological Geometrodynamics: Overview*. Onlinebook. [http://tgdtheory.com/public\\_html/tgdview/tgdview.html#evoII](http://tgdtheory.com/public_html/tgdview/tgdview.html#evoII), 2006.
- [K6] M. Pitkänen. An Overview about the Evolution of Quantum TGD. In *Topological Geometrodynamics: Overview*. Onlinebook. [http://tgdtheory.com/public\\_html/tgdview/tgdview.html#evoI](http://tgdtheory.com/public_html/tgdview/tgdview.html#evoI), 2006.
- [K7] M. Pitkänen. Anomalies Related to the Classical  $Z^0$  Force and Gravitation. In *TGD and Fringe Physics*. Onlinebook. [http://tgdtheory.com/public\\_html/freenergy/freenergy.html#Zanom](http://tgdtheory.com/public_html/freenergy/freenergy.html#Zanom), 2006.
- [K8] M. Pitkänen. Appendix A: Quantum Groups and Related Structures. In *Towards M-Matrix*. Onlinebook. [http://tgdtheory.com/public\\_html/tgdquant/tgdquant.html#bialgebra](http://tgdtheory.com/public_html/tgdquant/tgdquant.html#bialgebra), 2006.
- [K9] M. Pitkänen. Basic Extremals of Kähler Action. In *Physics in Many-Sheeted Space-Time*. Onlinebook. [http://tgdtheory.com/public\\_html/tgdclass/tgdclass.html#class](http://tgdtheory.com/public_html/tgdclass/tgdclass.html#class), 2006.
- [K10] M. Pitkänen. *Bio-Systems as Conscious Holograms*. Onlinebook. [http://tgdtheory.com/public\\_html/hologram/hologram.html](http://tgdtheory.com/public_html/hologram/hologram.html), 2006.
- [K11] M. Pitkänen. Bio-Systems as Conscious Holograms. In *Bio-Systems as Conscious Holograms*. Onlinebook. [http://tgdtheory.com/public\\_html/hologram/hologram.html#hologram](http://tgdtheory.com/public_html/hologram/hologram.html#hologram), 2006.
- [K12] M. Pitkänen. *Bio-Systems as Self-Organizing Quantum Systems*. Onlinebook. [http://tgdtheory.com/public\\_html/bioselforg/bioselforg.html](http://tgdtheory.com/public_html/bioselforg/bioselforg.html), 2006.
- [K13] M. Pitkänen. Bio-Systems as Super-Conductors: part I. In *Quantum Hardware of Living Matter*. Onlinebook. [http://tgdtheory.com/public\\_html/bioware/bioware.html#superc1](http://tgdtheory.com/public_html/bioware/bioware.html#superc1), 2006.
- [K14] M. Pitkänen. Bio-Systems as Super-Conductors: part II. In *Quantum Hardware of Living Matter*. Onlinebook. [http://tgdtheory.com/public\\_html/bioware/bioware.html#superc2](http://tgdtheory.com/public_html/bioware/bioware.html#superc2), 2006.
- [K15] M. Pitkänen. Configuration Space Spinor Structure. In *Quantum Physics as Infinite-Dimensional Geometry*. Onlinebook. [http://tgdtheory.com/public\\_html/tgdgeom/tgdgeom.html#cspin](http://tgdtheory.com/public_html/tgdgeom/tgdgeom.html#cspin), 2006.

- [K16] M. Pitkänen. Construction of elementary particle vacuum functionals. In *p-Adic Length Scale Hypothesis and Dark Matter Hierarchy*. Onlinebook. [http://tgdtheory.com/public\\_html/paddark/paddark.html#elvafu](http://tgdtheory.com/public_html/paddark/paddark.html#elvafu), 2006.
- [K17] M. Pitkänen. Construction of Quantum Theory: M-matrix. In *Towards M-Matrix*. Onlinebook. [http://tgdtheory.com/public\\_html/tgdquant/tgdquant.html#towards](http://tgdtheory.com/public_html/tgdquant/tgdquant.html#towards), 2006.
- [K18] M. Pitkänen. Cosmic Strings. In *Physics in Many-Sheeted Space-Time*. Onlinebook. [http://tgdtheory.com/public\\_html/tgdclass/tgdclass.html#cstrings](http://tgdtheory.com/public_html/tgdclass/tgdclass.html#cstrings), 2006.
- [K19] M. Pitkänen. Crop Circles and Life at Parallel Space-Time Sheets. In *Magnetospheric Consciousness*. Onlinebook. [http://tgdtheory.com/public\\_html/magnconsc/magnconsc.html#crop1](http://tgdtheory.com/public_html/magnconsc/magnconsc.html#crop1), 2006.
- [K20] M. Pitkänen. Crop Circles and Life at Parallel Space-Time Sheets. In *Magnetospheric Consciousness*. Onlinebook. [http://tgdtheory.com/public\\_html/magnconsc/magnconsc.html#crop2](http://tgdtheory.com/public_html/magnconsc/magnconsc.html#crop2), 2006.
- [K21] M. Pitkänen. Dark Forces and Living Matter. In *p-Adic Length Scale Hypothesis and Dark Matter Hierarchy*. Onlinebook. [http://tgdtheory.com/public\\_html/paddark/paddark.html#darkforces](http://tgdtheory.com/public_html/paddark/paddark.html#darkforces), 2006.
- [K22] M. Pitkänen. Dark Matter Hierarchy and Hierarchy of EEGs. In *TGD and EEG*. Onlinebook. [http://tgdtheory.com/public\\_html/tgdeeg/tgdeeg.html#eegdark](http://tgdtheory.com/public_html/tgdeeg/tgdeeg.html#eegdark), 2006.
- [K23] M. Pitkänen. Dark Nuclear Physics and Condensed Matter. In *p-Adic Length Scale Hypothesis and Dark Matter Hierarchy*. Onlinebook. [http://tgdtheory.com/public\\_html/paddark/paddark.html#exonuclear](http://tgdtheory.com/public_html/paddark/paddark.html#exonuclear), 2006.
- [K24] M. Pitkänen. DNA as Topological Quantum Computer. In *Genes and Memes*. Onlinebook. [http://tgdtheory.com/public\\_html/genememe/genememe.html#dnatqc](http://tgdtheory.com/public_html/genememe/genememe.html#dnatqc), 2006.
- [K25] M. Pitkänen. Does TGD Predict the Spectrum of Planck Constants? In *Towards M-Matrix*. Onlinebook. [http://tgdtheory.com/public\\_html/tgdquant/tgdquant.html#Planck](http://tgdtheory.com/public_html/tgdquant/tgdquant.html#Planck), 2006.
- [K26] M. Pitkänen. Evolution in Many-Sheeted Space-Time. In *Genes and Memes*. Onlinebook. [http://tgdtheory.com/public\\_html/genememe/genememe.html#prebio](http://tgdtheory.com/public_html/genememe/genememe.html#prebio), 2006.
- [K27] M. Pitkänen. General Ideas about Many-Sheeted Space-Time: Part I. In *Physics in Many-Sheeted Space-Time*. Onlinebook. [http://tgdtheory.com/public\\_html/tgdclass/tgdclass.html#topcond](http://tgdtheory.com/public_html/tgdclass/tgdclass.html#topcond), 2006.
- [K28] M. Pitkänen. General Theory of Qualia. In *Bio-Systems as Conscious Holograms*. Onlinebook. [http://tgdtheory.com/public\\_html/hologram/hologram.html#qualia](http://tgdtheory.com/public_html/hologram/hologram.html#qualia), 2006.
- [K29] M. Pitkänen. *Genes and Memes*. Onlinebook. [http://tgdtheory.com/public\\_html/genememe/genememe.html](http://tgdtheory.com/public_html/genememe/genememe.html), 2006.
- [K30] M. Pitkänen. Genes and Memes. In *Genes and Memes*. Onlinebook. [http://tgdtheory.com/public\\_html/genememe/genememe.html#genememec](http://tgdtheory.com/public_html/genememe/genememe.html#genememec), 2006.
- [K31] M. Pitkänen. Homeopathy in Many-Sheeted Space-Time. In *Bio-Systems as Conscious Holograms*. Onlinebook. [http://tgdtheory.com/public\\_html/hologram/hologram.html#homeoc](http://tgdtheory.com/public_html/hologram/hologram.html#homeoc), 2006.
- [K32] M. Pitkänen. Macro-Temporal Quantum Coherence and Spin Glass Degeneracy. In *Bio-Systems as Conscious Holograms*. Onlinebook. [http://tgdtheory.com/public\\_html/hologram/hologram.html#macro](http://tgdtheory.com/public_html/hologram/hologram.html#macro), 2006.
- [K33] M. Pitkänen. Macroscopic Quantum Coherence and Quantum Metabolism as Different Sides of the Same Coin. In *Bio-Systems as Conscious Holograms*. Onlinebook. [http://tgdtheory.com/public\\_html/hologram/hologram.html#metab](http://tgdtheory.com/public_html/hologram/hologram.html#metab), 2006.



- [K34] M. Pitkänen. Macroscopic Quantum Phenomena and  $CP_2$  Geometry. In *Physics in Many-Sheeted Space-Time*. Onlinebook. [http://tgdtheory.com/public\\_html/tgdclass/tgdclass.html#super](http://tgdtheory.com/public_html/tgdclass/tgdclass.html#super), 2006.
- [K35] M. Pitkänen. Magnetic Sensory Canvas Hypothesis. In *TGD and EEG*. Onlinebook. [http://tgdtheory.com/public\\_html//tgdeeg/tgdeeg/tgdeeg.html#mec](http://tgdtheory.com/public_html//tgdeeg/tgdeeg/tgdeeg.html#mec), 2006.
- [K36] M. Pitkänen. *Magnetospheric Consciousness*. Onlinebook. [http://tgdtheory.com/public\\_html/magnconsc/magnconsc.html](http://tgdtheory.com/public_html/magnconsc/magnconsc.html), 2006.
- [K37] M. Pitkänen. Magnetospheric Sensory Representations. In *Magnetospheric Consciousness*. Onlinebook. [http://tgdtheory.com/public\\_html/magnconsc/magnconsc.html#srepres](http://tgdtheory.com/public_html/magnconsc/magnconsc.html#srepres), 2006.
- [K38] M. Pitkänen. Many-Sheeted DNA. In *Genes and Memes*. Onlinebook. [http://tgdtheory.com/public\\_html/genememe/genememe.html#genecodec](http://tgdtheory.com/public_html/genememe/genememe.html#genecodec), 2006.
- [K39] M. Pitkänen. Massless states and particle massivation. In *p-Adic Length Scale Hypothesis and Dark Matter Hierarchy*. Onlinebook. [http://tgdtheory.com/public\\_html/paddark/paddark.html#mless](http://tgdtheory.com/public_html/paddark/paddark.html#mless), 2006.
- [K40] M. Pitkänen. *Mathematical Aspects of Consciousness Theory*. Onlinebook. [http://tgdtheory.com/public\\_html/mathconsc/mathconsc.html](http://tgdtheory.com/public_html/mathconsc/mathconsc.html), 2006.
- [K41] M. Pitkänen. Matter, Mind, Quantum. In *TGD Inspired Theory of Consciousness*. Onlinebook. [http://tgdtheory.com/public\\_html/tgdconsc/tgdconsc.html#conscic](http://tgdtheory.com/public_html/tgdconsc/tgdconsc.html#conscic), 2006.
- [K42] M. Pitkänen. Negentropy Maximization Principle. In *TGD Inspired Theory of Consciousness*. Onlinebook. [http://tgdtheory.com/public\\_html/tgdconsc/tgdconsc.html#nmpc](http://tgdtheory.com/public_html/tgdconsc/tgdconsc.html#nmpc), 2006.
- [K43] M. Pitkänen. New Particle Physics Predicted by TGD: Part I. In *p-Adic Length Scale Hypothesis and Dark Matter Hierarchy*. Onlinebook. [http://tgdtheory.com/public\\_html/paddark/paddark.html#mass4](http://tgdtheory.com/public_html/paddark/paddark.html#mass4), 2006.
- [K44] M. Pitkänen. Nuclear String Hypothesis. In *p-Adic Length Scale Hypothesis and Dark Matter Hierarchy*. Onlinebook. [http://tgdtheory.com/public\\_html/paddark/paddark.html#nuclstring](http://tgdtheory.com/public_html/paddark/paddark.html#nuclstring), 2006.
- [K45] M. Pitkänen. *p-Adic length Scale Hypothesis and Dark Matter Hierarchy*. Onlinebook. [http://tgdtheory.com/public\\_html/paddark/paddark.html](http://tgdtheory.com/public_html/paddark/paddark.html), 2006.
- [K46] M. Pitkänen. p-Adic Particle Massivation: Hadron Masses. In *p-Adic Length Scale Hypothesis and Dark Matter Hierarchy*. Onlinebook. [http://tgdtheory.com/public\\_html/paddark/paddark.html#mass3](http://tgdtheory.com/public_html/paddark/paddark.html#mass3), 2006.
- [K47] M. Pitkänen. p-Adic Physics as Physics of Cognition and Intention. In *TGD Inspired Theory of Consciousness*. Onlinebook. [http://tgdtheory.com/public\\_html/tgdconsc/tgdconsc.html#cognic](http://tgdtheory.com/public_html/tgdconsc/tgdconsc.html#cognic), 2006.
- [K48] M. Pitkänen. *Physics in Many-Sheeted Space-Time*. Onlinebook. [http://tgdtheory.com/public\\_html/tgdclass/tgdclass.html](http://tgdtheory.com/public_html/tgdclass/tgdclass.html), 2006.
- [K49] M. Pitkänen. Quantum Antenna Hypothesis. In *Quantum Hardware of Living Matter*. Onlinebook. [http://tgdtheory.com/public\\_html/bioware/bioware.html#tubuc](http://tgdtheory.com/public_html/bioware/bioware.html#tubuc), 2006.
- [K50] M. Pitkänen. Quantum Astrophysics. In *Physics in Many-Sheeted Space-Time*. Onlinebook. [http://tgdtheory.com/public\\_html/tgdclass/tgdclass.html#qastro](http://tgdtheory.com/public_html/tgdclass/tgdclass.html#qastro), 2006.
- [K51] M. Pitkänen. Quantum Control and Coordination in Bio-systems: Part I. In *Bio-Systems as Self-Organizing Quantum Systems*. Onlinebook. [http://tgdtheory.com/public\\_html/bioselforg/bioselforg.html#qcococI](http://tgdtheory.com/public_html/bioselforg/bioselforg.html#qcococI), 2006.
- [K52] M. Pitkänen. Quantum Control and Coordination in Bio-Systems: Part II. In *Bio-Systems as Self-Organizing Quantum Systems*. Onlinebook. [http://tgdtheory.com/public\\_html/bioselforg/bioselforg.html#qcococII](http://tgdtheory.com/public_html/bioselforg/bioselforg.html#qcococII), 2006.

- [K53] M. Pitkänen. *Quantum Hardware of Living Matter*. Onlinebook. [http://tgdtheory.com/public\\_html/bioware/bioware.html](http://tgdtheory.com/public_html/bioware/bioware.html), 2006.
- [K54] M. Pitkänen. Quantum Model for Hearing. In *TGD and EEG*. Onlinebook. [http://tgdtheory.com/public\\_html//tgdeeg/tgdeeg/tgdeeg.html#hearing](http://tgdtheory.com/public_html//tgdeeg/tgdeeg/tgdeeg.html#hearing), 2006.
- [K55] M. Pitkänen. Quantum Model for Nerve Pulse. In *TGD and EEG*. Onlinebook. [http://tgdtheory.com/public\\_html//tgdeeg/tgdeeg/tgdeeg.html#pulse](http://tgdtheory.com/public_html//tgdeeg/tgdeeg/tgdeeg.html#pulse), 2006.
- [K56] M. Pitkänen. Quantum Model for Paranormal Phenomena. In *TGD Inspired Theory of Consciousness*. Onlinebook. [http://tgdtheory.com/public\\_html/tgdconsc/tgdconsc.html#parac](http://tgdtheory.com/public_html/tgdconsc/tgdconsc.html#parac), 2006.
- [K57] M. Pitkänen. Quantum Model for Sensory Representations. In *TGD Inspired Theory of Consciousness*. Onlinebook. [http://tgdtheory.com/public\\_html/tgdconsc/tgdconsc.html#expc](http://tgdtheory.com/public_html/tgdconsc/tgdconsc.html#expc), 2006.
- [K58] M. Pitkänen. Quantum Model of EEG. In *TGD and EEG*. Onlinebook. [http://tgdtheory.com/public\\_html/tgdeeg/tgdeeg.html#eegII](http://tgdtheory.com/public_html/tgdeeg/tgdeeg.html#eegII), 2006.
- [K59] M. Pitkänen. Quantum Model of Memory. In *TGD Inspired Theory of Consciousness*. Onlinebook. [http://tgdtheory.com/public\\_html/tgdconsc/tgdconsc.html#memoryc](http://tgdtheory.com/public_html/tgdconsc/tgdconsc.html#memoryc), 2006.
- [K60] M. Pitkänen. *Quantum Physics as Infinite-Dimensional Geometry*. Onlinebook. [http://tgdtheory.com/public\\_html/tgdgeom/tgdgeom.html](http://tgdtheory.com/public_html/tgdgeom/tgdgeom.html), 2006.
- [K61] M. Pitkänen. *Quantum TGD*. Onlinebook. [http://tgdtheory.com/public\\_html/tgdquant/tgdquant.html](http://tgdtheory.com/public_html/tgdquant/tgdquant.html), 2006.
- [K62] M. Pitkänen. Quantum Theory of Self-Organization. In *Bio-Systems as Self-Organizing Quantum Systems*. Onlinebook. [http://tgdtheory.com/public\\_html/bioselforg/bioselforg.html#selforgac](http://tgdtheory.com/public_html/bioselforg/bioselforg.html#selforgac), 2006.
- [K63] M. Pitkänen. Semi-trance, Mental Illness, and Altered States of Consciousness. In *Magnetospheric Consciousness*. Onlinebook. [http://tgdtheory.com/public\\_html/magnconsc/magnconsc.html#semitrancec](http://tgdtheory.com/public_html/magnconsc/magnconsc.html#semitrancec), 2006.
- [K64] M. Pitkänen. Semitrance, Language, and Development of Civilization. In *Magnetospheric Consciousness*. Onlinebook. [http://tgdtheory.com/public\\_html/magnconsc/magnconsc.html#langsoc](http://tgdtheory.com/public_html/magnconsc/magnconsc.html#langsoc), 2006.
- [K65] M. Pitkänen. TGD and Astrophysics. In *Physics in Many-Sheeted Space-Time*. Onlinebook. [http://tgdtheory.com/public\\_html/tgdclass/tgdclass.html#astro](http://tgdtheory.com/public_html/tgdclass/tgdclass.html#astro), 2006.
- [K66] M. Pitkänen. TGD and Cosmology. In *Physics in Many-Sheeted Space-Time*. Onlinebook. [http://tgdtheory.com/public\\_html/tgdclass/tgdclass.html#cosmo](http://tgdtheory.com/public_html/tgdclass/tgdclass.html#cosmo), 2006.
- [K67] M. Pitkänen. *TGD and EEG*. Onlinebook. [http://tgdtheory.com/public\\_html/tgdeeg/tgdeeg.html](http://tgdtheory.com/public_html/tgdeeg/tgdeeg.html), 2006.
- [K68] M. Pitkänen. *TGD and Fringe Physics*. Onlinebook. [http://tgdtheory.com/public\\_html/freenergy/freenergy.html](http://tgdtheory.com/public_html/freenergy/freenergy.html), 2006.
- [K69] M. Pitkänen. TGD and Nuclear Physics. In *p-Adic Length Scale Hypothesis and Dark Matter Hierarchy*. Onlinebook. [http://tgdtheory.com/public\\_html/paddark/paddark.html#padnucl](http://tgdtheory.com/public_html/paddark/paddark.html#padnucl), 2006.
- [K70] M. Pitkänen. *TGD as a Generalized Number Theory*. Onlinebook. [http://tgdtheory.com/public\\_html/tgdnumber/tgdnumber.html](http://tgdtheory.com/public_html/tgdnumber/tgdnumber.html), 2006.
- [K71] M. Pitkänen. TGD as a Generalized Number Theory: p-Adicization Program. In *TGD as a Generalized Number Theory*. Onlinebook. [http://tgdtheory.com/public\\_html/tgdnumber/tgdnumber.html#visiona](http://tgdtheory.com/public_html/tgdnumber/tgdnumber.html#visiona), 2006.

- [K72] M. Pitkänen. TGD as a Generalized Number Theory: Quaternions, Octonions, and their Hyper Counterparts. In *TGD as a Generalized Number Theory*. Onlinebook. [http://tgdtheory.com/public\\_html/tgdnumber/tgdnumber.html#visionb](http://tgdtheory.com/public_html/tgdnumber/tgdnumber.html#visionb), 2006.
- [K73] M. Pitkänen. TGD Based Model for OBEs. In *TGD Inspired Theory of Consciousness*. Onlinebook. [http://tgdtheory.com/public\\_html/tgdconsc/tgdconsc.html#OBE](http://tgdtheory.com/public_html/tgdconsc/tgdconsc.html#OBE), 2006.
- [K74] M. Pitkänen. *TGD Inspired Theory of Consciousness*. Onlinebook. [http://tgdtheory.com/public\\_html/tgdconsc/tgdconsc.html](http://tgdtheory.com/public_html/tgdconsc/tgdconsc.html), 2006.
- [K75] M. Pitkänen. TGD Inspired Theory of Consciousness. In *Topological Geometrodynamics: Overview*. Onlinebook. [http://tgdtheory.com/public\\_html/tgdview/tgdview.html#tgdconsc2010](http://tgdtheory.com/public_html/tgdview/tgdview.html#tgdconsc2010), 2006.
- [K76] M. Pitkänen. The Notion of Free Energy and Many-Sheeted Space-Time Concept. In *TGD and Fringe Physics*. Onlinebook. [http://tgdtheory.com/public\\_html/freenergy/freenergy.html#freenergy](http://tgdtheory.com/public_html/freenergy/freenergy.html#freenergy), 2006.
- [K77] M. Pitkänen. The Relationship Between TGD and GRT. In *Physics in Many-Sheeted Space-Time*. Onlinebook. [http://tgdtheory.com/public\\_html/tgdclass/tgdclass.html#tgdgrt](http://tgdtheory.com/public_html/tgdclass/tgdclass.html#tgdgrt), 2006.
- [K78] M. Pitkänen. Three new physics realizations of the genetic code and the role of dark matter in bio-systems. In *Genes and Memes*. Onlinebook. [http://tgdtheory.com/public\\_html/genememe/genememe.html#dnatqccodes](http://tgdtheory.com/public_html/genememe/genememe.html#dnatqccodes), 2006.
- [K79] M. Pitkänen. Time, Spacetime and Consciousness. In *Bio-Systems as Conscious Holograms*. Onlinebook. [http://tgdtheory.com/public\\_html/hologram/hologram.html#time](http://tgdtheory.com/public_html/hologram/hologram.html#time), 2006.
- [K80] M. Pitkänen. *Topological Geometrodynamics: an Overview*. Onlinebook. [http://tgdtheory.com/public\\_html/tgdview/tgdview.html](http://tgdtheory.com/public_html/tgdview/tgdview.html), 2006.
- [K81] M. Pitkänen. Topological Quantum Computation in TGD Universe. In *Genes and Memes*. Onlinebook. [http://tgdtheory.com/public\\_html/genememe/genememe.html#tqc](http://tgdtheory.com/public_html/genememe/genememe.html#tqc), 2006.
- [K82] M. Pitkänen. Was von Neumann Right After All. In *Towards M-Matrix*. Onlinebook. [http://tgdtheory.com/public\\_html/tgdquant/tgdquant.html#vNeumann](http://tgdtheory.com/public_html/tgdquant/tgdquant.html#vNeumann), 2006.
- [K83] M. Pitkänen. Wormhole Magnetic Fields. In *Quantum Hardware of Living Matter*. Onlinebook. [http://tgdtheory.com/public\\_html/bioware/bioware.html#wormc](http://tgdtheory.com/public_html/bioware/bioware.html#wormc), 2006.



# Articles about TGD

- [L1] M. Pitkänen. Macro-temporal quantum coherence, quantum spin glass degeneracy, and number theoretic information concept. <http://www.emergentmind.org/journal.htm>, 2003.
- [L2] M. Pitkänen. Time, Space-Time, and Consciousness. <http://www.emergentmind.org/journal.htm>, 2003.
- [L3] M. Pitkänen. Further Progress in Nuclear String Hypothesis. <http://tgdtheory.com/articles/nuclstring.pdf>, 2007.
- [L4] M. Pitkänen. TGD based solution of Fermi paradox. <http://www.physics.helsinki.fi/~matpitka/articles/fermieng.pdf>, 2007.



Part IV

**HYPER-FINITE FACTORS AND  
HIERARCHY OF PLANCK  
CONSTANTS**





## Chapter 13

# Was von Neumann Right After All?

### 13.1 Introduction

The work with TGD inspired model [K81] for topological quantum computation [?] led to the realization that von Neumann algebras [?, ?, ?, ?], in particular so called hyper-finite factors of type  $II_1$  [?], seem to provide the mathematics needed to develop a more explicit view about the construction of S-matrix. In this chapter I will discuss various aspects of type  $II_1$  factors and their physical interpretation in TGD framework. The lecture notes of R. Longo [?] give a concise and readable summary about the basic definitions and results related to von Neumann algebras and I have used this material freely in this chapter. The original discussion has transformed during years from free speculation reflecting in many aspects my ignorance about the mathematics involved to a more realistic view about the role of these algebras in quantum TGD.

#### 13.1.1 Philosophical ideas behind von Neumann algebras

The goal of von Neumann was to generalize the algebra of quantum mechanical observables. The basic ideas behind the von Neumann algebra are dictated by physics. The algebra elements allow Hermitian conjugation  $*$  and observables correspond to Hermitian operators. Any measurable function  $f(A)$  of operator  $A$  belongs to the algebra and one can say that non-commutative measure theory is in question.

The predictions of quantum theory are expressible in terms of traces of observables. Density matrix defining expectations of observables in ensemble is the basic example. The highly non-trivial requirement of von Neumann was that identical a priori probabilities for a detection of states of infinite state system must make sense. Since quantum mechanical expectation values are expressible in terms of operator traces, this requires that unit operator has unit trace:  $tr(Id) = 1$ .

In the finite-dimensional case it is easy to build observables out of minimal projections to 1-dimensional eigen spaces of observables. For infinite-dimensional case the probability of projection to 1-dimensional sub-space vanishes if each state is equally probable. The notion of observable must thus be modified by excluding 1-dimensional minimal projections, and allow only projections for which the trace would be infinite using the straightforward generalization of the matrix algebra trace as the dimension of the projection.

The non-trivial implication of the fact that traces of projections are never larger than one is that the eigen spaces of the density matrix must be infinite-dimensional for non-vanishing projection probabilities. Quantum measurements can lead with a finite probability only to mixed states with a density matrix which is projection operator to infinite-dimensional subspace. The simple von Neumann algebras for which unit operator has unit trace are known as factors of type  $II_1$  [?].

The definitions adopted by von Neumann allow however more general algebras. Type  $I_n$  algebras correspond to finite-dimensional matrix algebras with finite traces whereas  $I_\infty$  associated with a separable infinite-dimensional Hilbert space does not allow bounded traces. For algebras of type  $III$  non-trivial traces are always infinite and the notion of trace becomes useless being replaced by the notion of state which is generalization of the notion of thermodynamical state. The fascinating feature of this notion of state is that it defines a unique modular automorphism of the factor defined apart from unitary inner automorphism and the question is whether this notion or its generalization might be relevant for the construction of M-matrix in TGD.

### 13.1.2 Von Neumann, Dirac, and Feynman

The association of algebras of type  $I$  with the standard quantum mechanics allowed to unify matrix mechanism with wave mechanics. Note however that the assumption about continuous momentum state basis is in conflict with separability but the particle-in-box idealization allows to circumvent this problem (the notion of space-time sheet brings the box in physics as something completely real).

Because of the finiteness of traces von Neumann regarded the factors of type  $II_1$  as fundamental and factors of type  $III$  as pathological. The highly pragmatic and successful approach of Dirac [?] based on the notion of delta function, plus the emergence of  $s$  [?], the possibility to formulate the notion of delta function rigorously in terms of distributions [?, ?], and the emergence of path integral approach [?] meant that von Neumann approach was forgotten by particle physicists.

Algebras of type  $II_1$  have emerged only much later in conformal and topological quantum field theories [?, ?] allowing to deduce invariants of knots, links and 3-manifolds. Also algebraic structures known as bi-algebras, Hopf algebras, and ribbon algebras [?] relate closely to type  $II_1$  factors. In topological quantum computation [?] based on braid groups [?] modular S-matrices they play an especially important role.

In algebraic quantum field theory [?] defined in Minkowski space the algebras of observables associated with bounded space-time regions correspond quite generally to the type  $III_1$  hyper-finite factor [?, ?].

### 13.1.3 Hyper-finite factors in quantum TGD

The following argument suggests that von Neumann algebras known as hyper-finite factors (HFFs) of type  $III_1$  appearing in relativistic quantum field theories provide also the proper mathematical framework for quantum TGD.

1. The Clifford algebra of the infinite-dimensional Hilbert space is a von Neumann algebra known as HFF of type  $II_1$ . There also the Clifford algebra at a given point (light-like 3-surface) of world of classical worlds (WCW) is therefore HFF of type  $II_1$ . If the fermionic Fock algebra defined by the fermionic oscillator operators assignable to the induced spinor fields (this is actually not obvious!) is infinite-dimensional it defines a representation for HFF of type  $II_1$ . Super-conformal symmetry suggests that the extension of the Clifford algebra defining the fermionic part of a super-conformal algebra by adding bosonic super-generators representing symmetries of WCW respects the HFF property. It could however occur that HFF of type  $II_\infty$  results.
2. WCW is a union of sub-WCWs associated with causal diamonds ( $CD$ ) defined as intersections of future and past directed light-cones. One can allow also unions of  $CD$ s and the proposal is that  $CD$ s within  $CD$ s are possible. Whether  $CD$ s can intersect is not clear.
3. The assumption that the  $M^4$  proper distance  $a$  between the tips of  $CD$  is quantized in powers of 2 reproduces p-adic length scale hypothesis but one must also consider the possibility that  $a$  can have all possible values. Since  $SO(3)$  is the isotropy group of  $CD$ , the  $CD$ s associated with a given value of  $a$  and with fixed lower tip are parameterized by the Lobatchevski space  $L(a) = SO(3,1)/SO(3)$ . Therefore the  $CD$ s with a free position of lower tip are parameterized by  $M^4 \times L(a)$ . A possible interpretation is in terms of quantum cosmology with  $a$  identified as cosmic time [K66]. Since Lorentz boosts define a non-compact group, the generalization of so called crossed product construction strongly suggests that the local Clifford algebra of WCW is HFF of type  $III_1$ . If one allows all values of  $a$ , one ends up with  $M^4 \times M^4_+$  as the space of moduli for WCW.
4. An interesting special aspect of 8-dimensional Clifford algebra with Minkowski signature is that it allows an octonionic representation of gamma matrices obtained as tensor products of unit matrix 1 and 7-D gamma matrices  $\gamma_k$  and Pauli sigma matrices by replacing 1 and  $\gamma_k$  by octonions. This inspires the idea that it might be possible to end up with quantum TGD from purely number theoretical arguments. This seems to be the case. One can start from a local octonionic Clifford algebra in  $M^8$ . Associativity condition is satisfied if one restricts the octonionic algebra to a subalgebra associated with any hyper-quaternionic and thus 4-D sub-manifold of  $M^8$ . This means that the modified gamma matrices associated with the Kähler action span a complex quaternionic sub-space at each point of the sub-manifold. This associative

sub-algebra can be mapped a matrix algebra. Together with  $M^8 - H$  duality [K15, ?] this leads automatically to quantum TGD and therefore also to the notion of WCW and its Clifford algebra which is however only mappable to an associative algebra and thus to HFF of type  $\text{II}_1$ .

### 13.1.4 Hyper-finite factors and M-matrix

HFFs of type  $\text{III}_1$  provide a general vision about M-matrix.

1. The factors of type III allow unique modular automorphism  $\Delta^{it}$  (fixed apart from unitary inner automorphism). This raises the question whether the modular automorphism could be used to define the M-matrix of quantum TGD. This is not the case as is obvious already from the fact that unitary time evolution is not a sensible concept in zero energy ontology.
2. Concerning the identification of M-matrix the notion of state as it is used in theory of factors is a more appropriate starting point than the notion modular automorphism but as a generalization of thermodynamical state is certainly not enough for the purposes of quantum TGD and quantum field theories (algebraic quantum field theorists might disagree!). Zero energy ontology requires that the notion of thermodynamical state should be replaced with its "complex square root" abstracting the idea about M-matrix as a product of positive square root of a diagonal density matrix and a unitary S-matrix. This generalization of thermodynamical state -if it exists- would provide a firm mathematical basis for the notion of M-matrix and for the fuzzy notion of path integral.
3. The existence of the modular automorphisms relies on Tomita-Takesaki theorem, which assumes that the Hilbert space in which HFF acts allows cyclic and separable vector serving as ground state for both HFF and its commutant. The translation to the language of physicists states that the vacuum is a tensor product of two vacua annihilated by annihilation oscillator type algebra elements of HFF and creation operator type algebra elements of its commutant isomorphic to it. Note however that these algebras commute so that the two algebras are not hermitian conjugates of each other. This kind of situation is exactly what emerges in zero energy ontology: the two vacua can be assigned with the positive and negative energy parts of the zero energy states entangled by M-matrix.
4. There exists infinite number of thermodynamical states related by modular automorphisms. This must be true also for their possibly existing "complex square roots". Physically they would correspond to different measurement interactions giving rise to Kähler functions of WCW differing only by a real part of holomorphic function of complex coordinates of WCW and arbitrary function of zero mode coordinates and giving rise to the same Kähler metric of WCW.

The concrete construction of M-matrix utilizing the idea of bosonic emergence (bosons as fermion anti-fermion pairs at opposite throats of wormhole contact) meaning that bosonic propagators reduce to fermionic loops identifiable as wormhole contacts leads to generalized Feynman rules for M-matrix in which modified Dirac action containing measurement interaction term defines stringy propagators. This M-matrix should be consistent with the above proposal.

### 13.1.5 Connes tensor product as a realization of finite measurement resolution

The inclusions  $\mathcal{N} \subset \mathcal{M}$  of factors allow an attractive mathematical description of finite measurement resolution in terms of Connes tensor product but do not fix M-matrix as was the original optimistic belief.

1. In zero energy ontology  $\mathcal{N}$  would create states experimentally indistinguishable from the original one. Therefore  $\mathcal{N}$  takes the role of complex numbers in non-commutative quantum theory. The space  $\mathcal{M}/\mathcal{N}$  would correspond to the operators creating physical states modulo measurement resolution and has typically fractal dimension given as the index of the inclusion. The corresponding spinor spaces have an identification as quantum spaces with non-commutative  $\mathcal{N}$ -valued coordinates.

2. This leads to an elegant description of finite measurement resolution. Suppose that a universal M-matrix describing the situation for an ideal measurement resolution exists as the idea about square root of state encourages to think. Finite measurement resolution forces to replace the probabilities defined by the M-matrix with their  $\mathcal{N}$  "averaged" counterparts. The "averaging" would be in terms of the complex square root of  $\mathcal{N}$ -state and a direct analog of functionally or path integral over the degrees of freedom below measurement resolution defined by (say) length scale cutoff.
3. One can construct also directly M-matrices satisfying the measurement resolution constraint. The condition that  $\mathcal{N}$  acts like complex numbers on M-matrix elements as far as  $\mathcal{N}$ -"averaged" probabilities are considered is satisfied if M-matrix is a tensor product of M-matrix in  $\mathcal{M}(\mathcal{N}$  interpreted as finite-dimensional space with a projection operator to  $\mathcal{N}$ . The condition that  $\mathcal{N}$  averaging in terms of a complex square root of  $\mathcal{N}$  state produces this kind of M-matrix poses a very strong constraint on M-matrix if it is assumed to be universal (apart from variants corresponding to different measurement interactions).

### 13.1.6 Quantum spinors and fuzzy quantum mechanics

The notion of quantum spinor leads to a quantum mechanical description of fuzzy probabilities. For quantum spinors state function reduction cannot be performed unless quantum deformation parameter equals to  $q = 1$ . The reason is that the components of quantum spinor do not commute: it is however possible to measure the commuting operators representing moduli squared of the components giving the probabilities associated with 'true' and 'false'. The universal eigenvalue spectrum for probabilities does not in general contain (1,0) so that quantum qbits are inherently fuzzy. State function reduction would occur only after a transition to  $q=1$  phase and decoherence is not a problem as long as it does not induce this transition.

This chapter represents a summary about the development of the ideas with last sections representing the recent latest about therealization and role of HFFs in TGD. I have saved the reader from those speculations that have turned out to reflect my own ignorance or are inconsistent with what I regarded established parts of quantum TGD.

## 13.2 Von Neumann algebras

In this section basic facts about von Neumann algebras are summarized using as a background material the concise summary given in the lecture notes of Longo [?] .

### 13.2.1 Basic definitions

A formal definition of von Neumann algebra [?, ?, ?] is as a \*-subalgebra of the set of bounded operators  $\mathcal{B}(\mathcal{H})$  on a Hilbert space  $\mathcal{H}$  closed under weak operator topology, stable under the conjugation  $J = *$ :  $x \rightarrow x^*$ , and containing identity operator  $Id$ . This definition allows also von Neumann algebras for which the trace of the unit operator is not finite.

Identity operator is the only operator commuting with a simple von Neumann algebra. A general von Neumann algebra allows a decomposition as a direct integral of simple algebras, which von Neumann called factors. Classification of von Neumann algebras reduces to that for factors.

$\mathcal{B}(\mathcal{H})$  has involution  $*$  and is thus a \*-algebra.  $\mathcal{B}(\mathcal{H})$  has order order structure  $A \geq 0 : (Ax, x) \geq 0$ . This is equivalent to  $A = BB^*$  so that order structure is determined by algebraic structure.  $\mathcal{B}(\mathcal{H})$  has metric structure in the sense that norm defined as supremum of  $\|Ax\|, \|x\| \leq 1$  defines the notion of continuity.  $\|A\|^2 = \inf\{\lambda > 0 : AA^* \leq \lambda I\}$  so that algebraic structure determines metric structure.

There are also other topologies for  $\mathcal{B}(\mathcal{H})$  besides norm topology.

1.  $A_i \rightarrow A$  strongly if  $\|Ax - A_i x\| \rightarrow 0$  for all  $x$ . This topology defines the topology of  $C^*$  algebra.  $\mathcal{B}(\mathcal{H})$  is a Banach algebra that is  $\|AB\| \leq \|A\| \times \|B\|$  (inner product is not necessary) and also  $C^*$  algebra that is  $\|AA^*\| = \|A\|^2$ .
2.  $A_i \rightarrow A$  weakly if  $(A_i x, y) \rightarrow (Ax, y)$  for all pairs  $(x, y)$  (inner product is necessary). This topology defines the topology of von Neumann algebra as a sub-algebra of  $\mathcal{B}(\mathcal{H})$ .

Denote by  $M'$  the commutant of  $\mathcal{M}$  which is also algebra. Von Neumann's bicommutant theorem says that  $\mathcal{M}$  equals to its own bi-commutant. Depending on whether the identity operator has a finite trace or not, one distinguishes between algebras of type  $II_1$  and type  $II_\infty$ .  $II_1$  factor allow trace with properties  $tr(Id) = 1$ ,  $tr(xy) = tr(yx)$ , and  $tr(x^*x) > 0$ , for all  $x \neq 0$ . Let  $L^2(\mathcal{M})$  be the Hilbert space obtained by completing  $\mathcal{M}$  respect to the inner product defined  $\langle x|y \rangle = tr(x^*y)$  defines inner product in  $\mathcal{M}$  interpreted as Hilbert space. The normalized trace induces a trace in  $M'$ , natural trace  $Tr_{M'}$ , which is however not necessarily normalized.  $JxJ$  defines an element of  $M'$ : if  $\mathcal{H} = L^2(\mathcal{M})$ , the natural trace is given by  $Tr_{M'}(JxJ) = tr_M(x)$  for all  $x \in M$  and bounded.

### 13.2.2 Basic classification of von Neumann algebras

Consider first some definitions. First of all, Hermitian operators with positive trace expressible as products  $xx^*$  are of special interest since their sums with positive coefficients are also positive.

In quantum mechanics Hermitian operators can be expressed in terms of projectors to the eigen states. There is a natural partial order in the set of isomorphism classes of projectors by inclusion:  $E < F$  if the image of  $\mathcal{H}$  by  $E$  is contained to the image of  $\mathcal{H}$  by a suitable isomorph of  $F$ . Projectors are said to be metrically equivalent if there exist a partial isometry which maps the images  $\mathcal{H}$  by them to each other. In the finite-dimensional case metric equivalence means that isomorphism classes are identical  $E = F$ .

The algebras possessing a minimal projection  $E_0$  satisfying  $E_0 \leq F$  for any  $F$  are called type  $I$  algebras. Bounded operators of  $n$ -dimensional Hilbert space define algebras  $I_n$  whereas the bounded operators of infinite-dimensional separable Hilbert space define the algebra  $I_\infty$ .  $I_n$  and  $I_\infty$  correspond to the operator algebras of quantum mechanics. The states of harmonic oscillator correspond to a factor of type  $I$ .

The projection  $F$  is said to be finite if  $F < E$  and  $F \equiv E$  implies  $F = E$ . Hence metric equivalence means identity. Simple von Neumann algebras possessing finite projections but no minimal projections so that any projection  $E$  can be further decomposed as  $E = F + G$ , are called factors of type  $II$ .

Hyper-finiteness means that any finite set of elements can be approximated arbitrary well with the elements of a finite-dimensional sub-algebra. The hyper-finite  $II_\infty$  algebra can be regarded as a tensor product of hyper-finite  $II_1$  and  $I_\infty$  algebras. Hyper-finite  $II_1$  algebra can be regarded as a Clifford algebra of an infinite-dimensional separable Hilbert space sub-algebra of  $I_\infty$ .

Hyper-finite  $II_1$  algebra can be constructed using Clifford algebras  $C(2n)$  of  $2n$ -dimensional spaces and identifying the element  $x$  of  $2^n \times 2^n$  dimensional  $C(n)$  as the element  $diag(x, x)/2$  of  $2^{n+1} \times 2^{n+1}$ -dimensional  $C(n+1)$ . The union of algebras  $C(n)$  is formed and completed in the weak operator topology to give a hyper-finite  $II_1$  factor. This algebra defines the Clifford algebra of infinite-dimensional separable Hilbert space and is thus a sub-algebra of  $I_\infty$  so that hyper-finite  $II_1$  algebra is more regular than  $I_\infty$ .

von Neumann algebras possessing no finite projections (all traces are infinite or zero) are called algebras of type  $III$ . It was later shown by [?] [?] that these algebras are labeled by a parameter varying in the range  $[0, 1]$ , and referred to as algebras of type  $III_x$ .  $III_1$  category contains a unique hyper-finite algebra. It has been found that the algebras of observables associated with bounded regions of 4-dimensional Minkowski space in quantum field theories correspond to hyper-finite factors of type  $III_1$  [?]. Also statistical systems at finite temperature correspond to factors of type  $III$  and temperature parameterizes one-parameter set of automorphisms of this algebra [?]. Zero temperature limit correspond to  $I_\infty$  factor and infinite temperature limit to  $II_1$  factor.

### 13.2.3 Non-commutative measure theory and non-commutative topologies and geometries

von Neumann algebras and  $C^*$  algebras give rise to non-commutative generalizations of ordinary measure theory (integration), topology, and geometry. It must be emphasized that these structures are completely natural aspects of quantum theory. In particular, for the hyper-finite type  $II_1$  factors quantum groups and Kac Moody algebras [?] emerge quite naturally without any need for ad hoc modifications such as making space-time coordinates non-commutative. The effective 2-dimensionality of quantum TGD (partonic or stringy 2-surfaces code for states) means that these structures appear completely naturally in TGD framework.

### Non-commutative measure theory

von Neumann algebras define what might be a non-commutative generalization of measure theory and probability theory [?].

1. Consider first the commutative case. Measure theory is something more general than topology since the existence of measure (integral) does not necessitate topology. Any measurable function  $f$  in the space  $L^\infty(X, \mu)$  in measure space  $(X, \mu)$  defines a bounded operator  $M_f$  in the space  $\mathcal{B}(L^2(X, \mu))$  of bounded operators in the space  $L^2(X, \mu)$  of square integrable functions with action of  $M_f$  defined as  $M_f g = fg$ .
2. Integral over  $\mathcal{M}$  is very much like trace of an operator  $f_{x,y} = f(x)\delta(x,y)$ . Thus trace is a natural non-commutative generalization of integral (measure) to the non-commutative case and defined for von Neumann algebras. In particular, generalization of probability measure results if the case  $tr(Id) = 1$  and algebras of type  $I_n$  and  $II_1$  are thus very natural from the point of view of non-commutative probability theory.

The trace can be expressed in terms of a cyclic vector  $\Omega$  or vacuum/ground state in physicist's terminology.  $\Omega$  is said to be cyclic if the completion  $\overline{M\Omega} = H$  and separating if  $x\Omega$  vanishes only for  $x = 0$ .  $\Omega$  is cyclic for  $\mathcal{M}$  if and only if it is separating for  $M'$ . The expression for the trace given by

$$Tr(ab) = \left( \frac{(ab + ba)}{2}, \Omega \right) \quad (13.2.1)$$

is symmetric and allows to defined also inner product as  $(a, b) = Tr(a^*b)$  in  $\mathcal{M}$ . If  $\Omega$  has unit norm  $(\Omega, \Omega) = 1$ , unit operator has unit norm and the algebra is of type  $II_1$ . Fermionic oscillator operator algebra with discrete index labeling the oscillators defines  $II_1$  factor. Group algebra is second example of  $II_1$  factor.

The notion of probability measure can be abstracted using the notion of state. State  $\omega$  on a  $C^*$  algebra with unit is a positive linear functional on  $\mathcal{U}$ ,  $\omega(1) = 1$ . By so called KMS construction [?] any state  $\omega$  in  $C^*$  algebra  $\mathcal{U}$  can be expressed as  $\omega(x) = (\pi(x)\Omega, \Omega)$  for some cyclic vector  $\Omega$  and  $\pi$  is a homomorphism  $\mathcal{U} \rightarrow \mathcal{B}(\mathcal{H})$ .

### Non-commutative topology and geometry

$C^*$  algebras generalize in a well-defined sense ordinary topology to non-commutative topology.

1. In the Abelian case Gelfand Naimark theorem [?] states that there exists a contravariant functor  $F$  from the category of unital abelian  $C^*$  algebras and category of compact topological spaces. The inverse of this functor assigns to space  $X$  the continuous functions  $f$  on  $X$  with norm defined by the maximum of  $f$ . The functor assigns to these functions having interpretation as eigen states of mutually commuting observables defined by the function algebra. These eigen states are delta functions localized at single point of  $X$ . The points of  $X$  label the eigenfunctions and thus define the spectrum and obviously span  $X$ . The connection with topology comes from the fact that continuous map  $Y \rightarrow X$  corresponds to homomorphism  $C(X) \rightarrow C(Y)$ .
2. In non-commutative topology the function algebra  $C(X)$  is replaced with a general  $C^*$  algebra. Spectrum is identified as labels of simultaneous eigen states of the Cartan algebra of  $C^*$  and defines what can be observed about non-commutative space  $X$ .
3. Non-commutative geometry can be very roughly said to correspond to  $*$ -subalgebras of  $C^*$  algebras plus additional structure such as symmetries. The non-commutative geometry of Connes [?] is a basic example here.

#### 13.2.4 Modular automorphisms

von Neumann algebras allow a canonical unitary evolution associated with any state  $\omega$  fixed by the selection of the vacuum state  $\Omega$  [?]. This unitary evolution is an automorphism fixed apart form unitary automorphisms  $A \rightarrow UAU^*$  related with the choice of  $\Omega$ .

Let  $\omega$  be a normal faithful state:  $\omega(x^*x) > 0$  for any  $x$ . One can map  $\mathcal{M}$  to  $L^2(\mathcal{M})$  defined as a completion of  $\mathcal{M}$  by  $x \rightarrow x\Omega$ . The conjugation  $*$  in  $\mathcal{M}$  has image at Hilbert space level as a map  $S_0 : x\Omega \rightarrow x^*\Omega$ . The closure of  $S_0$  is an anti-linear operator and has polar decomposition  $S = J\Delta^{1/2}$ ,  $\Delta = SS^*$ .  $\Delta$  is positive self-adjoint operator and  $J$  anti-unitary involution. The following conditions are satisfied

$$\begin{aligned} \Delta^{it}\mathcal{M}\Delta^{-it} &= \mathcal{M} , \\ J\mathcal{M}J &= \mathcal{M}' . \end{aligned} \tag{13.2.2}$$

$\Delta^{it}$  is obviously analogous to the time evolution induced by positive definite Hamiltonian and induces also the evolution of the expectation  $\omega$  as  $\pi \rightarrow \Delta^{it}\pi\Delta^{-it}$ .

### 13.2.5 Joint modular structure and sectors

Let  $\mathcal{N} \subset \mathcal{M}$  be an inclusion. The unitary operator  $\gamma = J_N J_M$  defines a canonical endomorphisms  $M \rightarrow N$  in the sense that it depends only up to inner automorphism on  $\mathcal{N}$ ,  $\gamma$  defines a sector of  $\mathcal{M}$ . The sectors of  $\mathcal{M}$  are defined as  $Sect(\mathcal{M}) = End(\mathcal{M})/Inn(\mathcal{M})$  and form a semi-ring with respected to direct sum and composition by the usual operator product. It allows also conjugation.

$L^2(\mathcal{M})$  is a normal bi-module in the sense that it allows commuting left and right multiplications. For  $a, b \in M$  and  $x \in L^2(\mathcal{M})$  these multiplications are defined as  $axb = aJb^*Jx$  and it is easy to verify the commutativity using the factor  $Jy^*J \in \mathcal{M}'$ . [?] [?] has shown that all normal bi-modules arise in this way up to unitary equivalence so that representation concepts make sense. It is possible to assign to any endomorphism  $\rho$  index  $Ind(\rho) \equiv M : \rho(\mathcal{M})$ . This means that the sectors are in 1-1 correspondence with inclusions. For instance, in the case of hyper-finite  $II_1$  they are labeled by Jones index. Furthermore, the objects with non-integral dimension  $\sqrt{[M : \rho(\mathcal{M})]}$  can be identified as quantum groups, loop groups, infinite-dimensional Lie algebras, etc...

### 13.2.6 Basic facts about hyper-finite factors of type III

Hyper-finite factors of type  $II_1$ ,  $II_\infty$  and  $III_1$ ,  $III_0$ ,  $III_\lambda$ ,  $\lambda \in (0, 1)$ , allow by definition hierarchy of finite approximations and are unique as von Neumann algebras. Also hyper-finite factors of type  $II_\infty$  and type  $III$  could be relevant for the formulation of TGD. HFFs of type  $II_\infty$  and  $III$  could appear at the level operator algebra but that at the level of quantum states one would obtain HFFs of type  $II_1$ . These extended factors inspire highly non-trivial conjectures about quantum TGD. The book of Connes [?] provides a detailed view about von Neumann algebras in general.

#### Basic definitions and facts

A highly non-trivial result is that HFFs of type  $II_\infty$  are expressible as tensor products  $II_\infty = II_1 \otimes I_\infty$ , where  $II_1$  is hyper-finite [?] .

1. *The existence of one-parameter family of outer automorphisms*

The unique feature of factors of type  $III$  is the existence of one-parameter unitary group of outer automorphisms. The automorphism group originates in the following manner.

1. Introduce the notion of linear functional in the algebra as a map  $\omega : \mathcal{M} \rightarrow C$ .  $\omega$  is said to be hermitian it respects conjugation in  $\mathcal{M}$ ; positive if it is consistent with the notion of positivity for elements of  $\mathcal{M}$  in which case it is called weight; state if it is positive and normalized meaning that  $\omega(1) = 1$ , faithful if  $\omega(A) > 0$  for all positive  $A$ ; a trace if  $\omega(AB) = \omega(BA)$ , a vector state if  $\omega(A)$  is "vacuum expectation"  $\omega_\Omega(A) = (\Omega, \omega(A)\Omega)$  for a non-degenerate representation  $(\mathcal{H}, \pi)$  of  $\mathcal{M}$  and some vector  $\Omega \in \mathcal{H}$  with  $\|\Omega\| = 1$ .
2. The existence of trace is essential for hyper-finite factors of type  $II_1$ . Trace does not exist for factors of type  $III$  and is replaced with the weaker notion of state. State defines inner product via the formula  $(x, y) = \phi(y^*x)$  and  $*$  is isometry of the inner product.  $*$ -operator has property known as pre-closedness implying polar decomposition  $S = J\Delta^{1/2}$  of its closure.  $\Delta$  is positive definite unbounded operator and  $J$  is isometry which restores the symmetry between  $\mathcal{M}$  and its commutant  $\mathcal{M}'$  in the Hilbert space  $\mathcal{H}_\phi$ , where  $\mathcal{M}$  acts via left multiplication:  $\mathcal{M}' = J\mathcal{M}J$ .

3. The basic result of Tomita-Takesaki theory is that  $\Delta$  defines a one-parameter group  $\sigma_\phi^t(x) = \Delta^{it}x\Delta^{-it}$  of automorphisms of  $\mathcal{M}$  since one has  $\Delta^{it}\mathcal{M}\Delta^{-it} = \mathcal{M}$ . This unitary evolution is an automorphism fixed apart from unitary automorphism  $A \rightarrow UAU^*$  related with the choice of  $\phi$ . For factors of type I and II this automorphism reduces to inner automorphism so that the group of outer automorphisms is trivial as is also the outer automorphism associated with  $\omega$ . For factors of type III the group of these automorphisms divided by inner automorphisms gives a one-parameter group of  $Out(\mathcal{M})$  of outer automorphisms, which does not depend at all on the choice of the state  $\phi$ .

More precisely, let  $\omega$  be a normal faithful state:  $\omega(x^*x) > 0$  for any  $x$ . One can map  $\mathcal{M}$  to  $L^2(\mathcal{M})$  defined as a completion of  $\mathcal{M}$  by  $x \rightarrow x\Omega$ . The conjugation  $*$  in  $\mathcal{M}$  has image at Hilbert space level as a map  $S_0 : x\Omega \rightarrow x^*\Omega$ . The closure of  $S_0$  is an anti-linear operator and has polar decomposition  $S = J\Delta^{1/2}$ ,  $\Delta = SS^*$ .  $\Delta$  is positive self-adjoint operator and  $J$  anti-unitary involution. The following conditions are satisfied

$$\begin{aligned} \Delta^{it}\mathcal{M}\Delta^{-it} &= \mathcal{M} , \\ J\mathcal{M}J &= \mathcal{M}' . \end{aligned} \tag{13.2.3}$$

$\Delta^{it}$  is obviously analogous to the time evolution induced by positive definite Hamiltonian and induces also the evolution of the expectation  $\omega$  as  $\pi \rightarrow \Delta^{it}\pi\Delta^{-it}$ . What makes this result thought provoking is that it might mean a universal quantum dynamics apart from inner automorphisms and thus a realization of general coordinate invariance and gauge invariance at the level of Hilbert space.

2. Classification of HFFs of type III

Connes achieved an almost complete classification of hyper-finite factors of type III completed later by others. He demonstrated that they are labeled by single parameter  $0 \leq \lambda \leq 1$ ] and that factors of type  $III_\lambda$ ,  $0 \leq \lambda < 1$  are unique. Haagerup showed the uniqueness for  $\lambda = 1$ . The idea was that the the group has an invariant, the kernel  $T(M)$  of the map from time like  $R$  to  $Out(M)$ , consisting of those values of the parameter  $t$  for which  $\sigma_\phi^t$  reduces to an inner automorphism and to unity as outer automorphism. Connes also discovered also an invariant, which he called spectrum  $S(\mathcal{M})$  of  $\mathcal{M}$  identified as the intersection of spectra of  $\Delta_\phi \setminus \{0\}$ , which is closed multiplicative subgroup of  $R^+$ .

Connes showed that there are three cases according to whether  $S(\mathcal{M})$  is

1.  $R^+$ , type  $III_1$
2.  $\{\lambda^n, n \in Z\}$ , type  $III_\lambda$ .
3.  $\{1\}$ , type  $III_0$ .

The value range of  $\lambda$  is this by convention. For the reversal of the automorphism it would be that associated with  $1/\lambda$ .

Connes constructed also an explicit representation of the factors  $0 < \lambda < 1$  as crossed product  $II_\infty$  factor  $\mathcal{N}$  and group  $Z$  represented as powers of automorphism of  $II_\infty$  factor inducing the scaling of trace by  $\lambda$ . The classification of HFFs of type III reduced thus to the classification of automorphisms of  $\mathcal{N} \otimes \mathcal{B}(\mathcal{H})$ . In this sense the theory of HFFs of type III was reduced to that for HFFs of type  $II_\infty$  or even  $II_1$ . The representation of Connes might be also physically interesting.

**Probabilistic view about factors of type III**

Second very concise representation of HFFs relies on thermodynamical thinking and realizes factors as infinite tensor product of finite-dimensional matrix algebras acting on state spaces of finite state systems with a varying and finite dimension  $n$  such that one assigns to each factor a density matrix characterized by its eigen values. Intuitively one can think the finite matrix factors as associated with  $n$ -state system characterized by its energies with density matrix  $\rho$  defining a thermodynamics. The logarithm of the  $\rho$  defines the single particle quantum Hamiltonian as  $H = \log(\rho)$  and  $\Delta = \rho = \exp(H)$  defines the automorphism  $\sigma_\phi$  for each finite tensor factor as  $\exp(iHt)$ . Obviously free field representation is in question.

Depending on the asymptotic behavior of the eigenvalue spectrum one obtains different factors [?]



1. Factor of type I corresponds to ordinary thermodynamics for which the density matrix as a function of matrix factor approaches sufficiently fast that for a system for which only ground state has non-vanishing Boltzmann weight.
2. Factor of type  $II_1$  results if the density matrix approaches to identity matrix sufficiently fast. This means that the states are completely degenerate which for ordinary thermodynamics results only at the limit of infinite temperature. Spin glass could be a counterpart for this kind of situation.
3. Factor of type  $III$  results if one of the eigenvalues is above some lower bound for all tensor factors in such a manner that neither factor of type I or  $II_1$  results but thermodynamics for systems having infinite number of degrees of freedom could yield this kind of situation.

This construction demonstrates how varied representations factors can have, a fact which might look frustrating for a novice in the field. In particular, the infinite tensor power of  $M(2, C)$  with state defined as an infinite tensor power of  $M(2, C)$  state assigning to the matrix  $A$  the complex number  $(\lambda^{1/2} A_{11} + \lambda^{-1/2} \phi(A) = A_{22}) / (\lambda^{1/2} + \lambda^{-1/2})$  defines HFF  $III_\lambda$  [?] , [?] . Formally the same algebra which for  $\lambda = 1$  gives ordinary trace and HFF of type  $II_1$ , gives  $III$  factor only by replacing trace with state. This simple model was discovered by Powers in 1967.

It is indeed the notion of state or thermodynamics is what distinguishes between factors. This looks somewhat weird unless one realizes that the Hilbert space inner product is defined by the "thermodynamical" state  $\phi$  and thus probability distribution for operators and for their thermal expectation values. Inner product in turn defines the notion of norm and thus of continuity and it is this notion which differs dramatically for  $\lambda = 1$  and  $\lambda < 1$  so that the completions of the algebra differ dramatically.

In particular, there is no sign about  $I_\infty$  tensor factor or crossed product with  $Z$  represented as automorphisms inducing the scaling of trace by  $\lambda$ . By taking tensor product of  $I_\infty$  factor represented as tensor power with induces running from  $-\infty$  to 0 and  $II_1$  HFF with indices running from 1 to  $\infty$  one can make explicit the representation of the automorphism of  $II_\infty$  factor inducing scaling of trace by  $\lambda$  and transforming matrix factors possessing trace given by square root of index  $\mathcal{M} : \mathcal{N}$  to those with trace 2.

### 13.3 Braid group, von Neumann algebras, quantum TGD, and formation of bound states

The article of Vaughan Jones in [?] discusses the relation between knot theory, statistical physics, and von Neumann algebras. The intriguing results represented stimulate concrete ideas about how to understand the formation of bound states quantitatively using the notion of join along boundaries bond. All mathematical results represented in the following discussion can be found in [?] and in the references cited therein so that I will not bother to refer repeatedly to this article in the sequel.

#### 13.3.1 Factors of von Neumann algebras

Von Neumann algebras  $M$  are algebras of bounded linear operators acting in Hilbert space. These algebras contain identity, are closed with respect to Hermitian conjugation, and are topologically complete. Finite-dimensional von Neuman algebras decompose into a direct sum of algebras  $M_n$ , which act essentially as matrix algebras in Hilbert spaces  $\mathcal{H}_{nm}$ , which are tensor products  $C^n \otimes \mathcal{H}_m$ . Here  $\mathcal{H}_m$  is an  $m$ -dimensional Hilbert space in which  $M_n$  acts trivially.  $m$  is called the multiplicity of  $M_n$ .

A factor of von Neumann algebra is a von Neumann algebra whose center is just the scalar multiples of identity. The algebra of bounded operators in an infinite-dimensional Hilbert space is certainly a factor. This algebra decomposes into "atoms" represented by one-dimensional projection operators. This kind of von Neumann algebras are called type I factors.

The so called type  $II_1$  factors and type  $III$  factors came as a surprise even for Murray and von Neumann.  $II_1$  factors are infinite-dimensional and analogs of the matrix algebra factors  $M_n$ . They allow a trace making possible to define an inner product in the algebra. The trace defines a generalized dimension for any subspace as the trace of the corresponding projection operator. This dimension is

however continuous and in the range  $[0, 1]$ : the finite-dimensional analog would be the dimension of the sub-space divided by the dimension of  $\mathcal{H}_n$  and having values  $(0, 1/n, 2/n, \dots, 1)$ .  $\text{II}_1$  factors are isomorphic and there exists a minimal "hyper-finite"  $\text{II}_1$  factor is contained by every other  $\text{II}_1$  factor.

Just as in the finite-dimensional case, one can to assign a multiplicity to the Hilbert spaces where  $\text{II}_1$  factors act on. This multiplicity, call it  $\dim_M(\mathcal{H})$  is analogous to the dimension of the Hilbert space tensor factor  $\mathcal{H}_m$ , in which  $\text{II}_1$  factor acts trivially. This multiplicity can have all positive real values. Quite generally, von Neumann factors of type I and  $\text{II}_1$  are in many respects analogous to the coefficient field of a vector space.

### 13.3.2 Sub-factors

Sub-factors  $N \subset M$ , where  $N$  and  $M$  are of type  $\text{II}_1$  and have same identity, can be also defined. The observation that  $M$  is analogous to an algebraic extension of  $N$  motivates the introduction of index  $|M : N|$ , which is essentially the dimension of  $M$  with respect to  $N$ . This dimension is an analog for the complex dimension of  $CP_2$  equal to 2 or for the algebraic dimension of the extension of p-adic numbers.

The following highly non-trivial results about the dimensions of the tensor factors hold true.

1. If  $N \subset M$  are  $\text{II}_1$  factors and  $|M : N| < 4$ , there is an integer  $n \geq 3$  such  $|M : N| = r = 4\cos^2(\pi/n)$ ,  $n \geq 3$ .
2. For each number  $r = 4\cos^2(\pi/n)$  and for all  $r \geq 4$  there is a sub-factor  $R_r \subset R$  with  $|R : R_r| = r$ .

One can say that  $M$  effectively decomposes to a tensor product of  $N$  with a space, whose dimension is quantized to a certain algebraic number  $r$ . The values of  $r$  corresponding to  $n = 3, 4, 5, 6, \dots$  are  $r = 1, 2, 1 + \Phi \simeq 2.61, 3, \dots$  and approach to the limiting value  $r = 4$ . For  $r \geq 4$  the dimension becomes continuous.

An even more intriguing result is that by starting from  $N \subset M$  with a projection  $e_N: M \rightarrow N$  one can extend  $M$  to a larger  $\text{II}_1$  algebra  $\langle M, e_N \rangle$  such that one has

$$\begin{aligned} |\langle M, e_N \rangle : M| &= |M : N| , \\ \text{tr}(xe_N) &= |M : N|^{-1}\text{tr}(x) , \quad x \in M . \end{aligned} \tag{13.3.1}$$

One can continue this process and the outcome is a tower of  $\text{II}_1$  factors  $M_i \subset M_{i+1}$  defined by  $M_1 = N$ ,  $M_2 = M$ ,  $M_{i+1} = \langle M_i, e_{M_{i-1}} \rangle$ . Furthermore, the projection operators  $e_{M_i} \equiv e_i$  define a Temperley-Lieb representation of the braid algebra via the formulas

$$\begin{aligned} e_i^2 &= e_i , \\ e_i e_{i\pm 1} e_i &= \tau e_i , \quad \tau = 1/|M : N| \\ e_i e_j &= e_j e_i , \quad |i - j| \geq 2 . \end{aligned} \tag{13.3.2}$$

Temperley Lieb algebra will be discussed in more detail later. Obviously the addition of a tensor factor of dimension  $r$  is analogous with the addition of a strand to a braid.

The hyper-finite algebra  $R$  is generated by the set of braid generators  $\{e_1, e_2, \dots\}$  in the braid representation corresponding to  $r$ . Sub-factor  $R_1$  is obtained simply by dropping the lowest generator  $e_1$ ,  $R_2$  by dropping  $e_1$  and  $e_2$ , etc..

### 13.3.3 $\text{II}_1$ factors and the spinor structure of infinite-dimensional configuration space of 3-surfaces

The following observations serve as very suggestive guidelines for how one could interpret the above described results in TGD framework.

1. The discrete spectrum of dimensions  $1, 2, 1 + \Phi, 3, \dots$  below  $r < 4$  brings in mind the discrete energy spectrum for bound states whereas the for  $r \geq 4$  the spectrum of dimensions is analogous to a continuum of unbound states. The fact that  $r$  is an algebraic number for  $r < 4$  conforms

with the vision that bound state entanglement corresponds to entanglement probabilities in an extension of rationals defining a finite-dimensional extension of p-adic numbers for every prime  $p$ .

2. The discrete values of  $r$  correspond precisely to the angles  $\phi$  allowed by the unitarity of Temperley-Lieb representations of the braid algebra with  $d = -\sqrt{r}$ . For  $r \geq 4$  Temperley-Lieb representation is not unitary since  $\cos^2(\pi/n)$  becomes formally larger than one ( $n$  would become imaginary and continuous). This could mean that  $r \geq 4$ , which in the generic case is a transcendental number, represents unbound entanglement, which in TGD Universe is not stable against state preparation and state function reduction processes.
3. The formula  $tr(xe_N) = |M : N|^{-1}tr(x)$  is completely analogous to the formula characterizing the normalization of the link invariant induced by the second Markov move in which a new strand is added to a braid such that it braids only with the leftmost strand and therefore does not change the knot resulting as a link closure. Hence the addition of a single strand seems to correspond to an introduction of an  $r$ -dimensional sub-factor to  $II_1$  factor.

In TGD framework the generation of bound state has the formation of (possibly braided join along boundaries bonds as a space-time correlate and this encourages a rather concrete interpretation of these findings. Also the  $I_1$  factors themselves have a nice interpretation in terms of the configuration space spinor structure.

1. *The interpretation of  $II_1$  factors in terms of Clifford algebra of configuration space*

The Clifford algebra of an infinite-dimensional Hilbert space defines a  $II_1$  factor. The counterparts for  $e_i$  would naturally correspond to the analogs of projection operators  $(1 + \sigma_i)/2$  and thus to operators of form  $(1 + \Sigma_{ij})/2$ , defined by a subset of sigma matrices. The first guess is that the index pairs are  $(i, j) = (1, 2), (2, 3), (3, 4), \dots$ . The dimension of the Clifford algebra is  $2^N$  for  $N$ -dimensional space so that  $\Delta N = 1$  would correspond to  $r = 2$  in the classical case and to one qubit. The problem with this interpretation is  $r > 2$  has no physical interpretation: the formation of bound states is expected to reduce the value of  $r$  from its classical value rather than increase it.

One can however consider also the sequence  $(i, j) = (1, 1 + k), (1 + k, 1 + 2k), (1 + 2k, 1 + 3k), \dots$ . For  $k = 2$  the reduction of  $r$  from  $r = 4$  would be due to the loss of degrees of freedom due to the formation of a bound state and  $(r = 4, \Delta N = 2)$  would correspond to the classical limit resulting at the limit of weak binding. The effective elimination of the projection operators from the braid algebra would reflect this loss of degrees of freedom. This interpretation could at least be an appropriate starting point in TGD framework.

In TGD Universe physical states correspond to configuration space spinor fields, whose gamma matrix algebra is constructed in terms of second quantized free induced spinor fields defined at space-time sheets. The original motivation was the idea that the quantum states of the Universe correspond to the modes of purely classical free spinor fields in the infinite-dimensional configuration space of 3-surfaces (the world of classical worlds) possessing general coordinate invariant (in 4-dimensional sense!) Kähler geometry. Quantum information-theoretical motivation could have come from the requirement that these fields must be able to code information about the properties of the point (3-surface, and corresponding space-time sheet). Scalar fields would treat the 3-surfaces as points and are thus not enough. Induced spinor fields allow however an infinite number of modes: according to the naive Fourier analyst's intuition these modes are in one-one correspondence with the points of the 3-surface. Second quantization gives much more. Also non-local information about the induced geometry and topology must be coded, and here quantum entanglement for states generated by the fermionic oscillator operators coding information about the geometry of 3-surface provides enormous information storage capacity.

In algebraic geometry also the algebra of the imbedding space of algebraic variety divided by the ideal formed by functions vanishing on the surface codes information about the surface: for instance, the maximal ideals of this algebra code for the points of the surface (functions of imbedding space vanishing at a particular point). The function algebra of the imbedding space indeed plays a key role in the construction of the configuration space-geometry besides second quantized fermions.

The Clifford algebra generated by the configuration space gamma matrices at a given point (3-surface) of the configuration space of 3-surfaces could be regarded as a  $II_1$ -factor associated with the local tangent space endowed with Hilbert space structure (configuration space Kähler metric). The

counterparts for  $e_i$  would naturally correspond to the analogs of projection operators  $(1 + \sigma_i)/2$  and thus operators of form  $(G_{AB} \times 1 + \Sigma_{AB})$  formed as linear combinations of components of the Kähler metric and of the sigma matrices defined by gamma matrices and contracted with the generators of the isometries of the configuration space. The addition of single complex degree of freedom corresponds to  $\Delta N = 2$  and  $r = 4$  and the classical limit and would correspond to the addition of single braid. ( $r < 4, \Delta N < 2$ ) would be due to the binding effects.

$r = 1$  corresponds to  $\Delta N = 0$ . The first interpretation is in terms of strong binding so that the addition of particle does not increase the number of degrees of freedom. In TGD framework  $r = 1$  might also correspond to the addition of zero modes which do not contribute to the configuration space metric and spinor structure but have a deep physical significance. ( $r = 2, \Delta N = 1$ ) would correspond to strong binding reducing the spinor and space-time degrees of freedom by a factor of half.  $r = \Phi^2$  ( $n = 5$ ) resp.  $r = 3$  ( $n = 6$ ) corresponds to  $\Delta N_r \simeq 1.3885$  resp.  $\Delta N_r = 1.585$ . Using the terminology of quantum field theories, one might say that in the infinite-dimensional context a given complex bound state degree of freedom possesses anomalous real dimension  $r < 2$ .  $r \geq 4$  would correspond to a unbound entanglement and increasingly classical behavior.

### 13.3.4 About possible space-time correlates for the hierarchy of $\text{II}_1$ sub-factors

By quantum classical correspondence the infinite-dimensional physics at the configuration space level should have definite space-time correlates. In particular, the dimension  $r$  should have some fractal dimension as a space-time correlate.

#### 1. Quantum classical correspondence

Join along boundaries bonds serve as correlates for bound state formation. The presence of join along boundaries bonds would lead to a generation of bound states just by reducing the degrees of freedom to those of connected 3-surface. The bonds would constrain the two 3-surfaces to single space-like section of imbedding space.

This picture would allow to understand the difficulties related to Bethe-Salpeter equations for bound states based on the assumption that particles are points moving in  $M^4$ . The restriction of particles to time=constant section leads to a successful theory which is however non-relativistic. The basic binding energy would relate to the entanglement of the states associated with the bonded 3-surfaces. Since the classical energy associated with the bonds is positive, the binding energy tends to be reduced as  $r$  increases.

By spin glass degeneracy join along boundaries bonds have an infinite number of degrees of freedom in the ordinary sense. Since the system is infinite-dimensional and quantum critical, one expects that the number  $r$  of degrees freedom associated with a single join along boundaries bond is universal. Since join along boundaries bonds correspond to the strands of a braid and are correlates for the bound state formation, the natural guess is that  $r = 4\cos^2(\pi/n)$ ,  $n = 3, 4, 5, \dots$  holds true.  $r < 4$  should characterize both binding energy and the dimension of the effective tensor factor introduced by a new join along boundaries bond.

The assignment of 2 "bare" and  $\Delta N \leq 2$  renormalized real dimensions to single join along boundaries bond is consistent with the effective two-dimensionality of anyon systems and with the very notion of the braid group. The picture conforms also with the fact that the degrees of freedom in question are associated with metrically 2-dimensional light-like boundaries (of say magnetic flux tubes) acting as causal determinants. Also vibrational degrees of freedom described by Kac-Moody algebra are present and the effective 2-dimensionality means that these degrees of freedom are not excited and only topological degrees of freedom coded by the position of the puncture remain.

( $r \geq 4, \Delta N \geq 2$ ), if possible at all, would mean that the tensor factor associated with the join along boundaries bond is effectively more than 4-dimensional due to the excitation of the vibrational Kac-Moody degrees of freedom. The finite value of  $r$  would mean that most of them are eliminated also now but that their number is so large that bound state entanglement is not possible anymore.

The introduction of non-integer dimension could be seen as an effective description of an infinite-dimensional system as a finite-dimensional system in the spirit of renormalization group philosophy. The non-unitarity of  $r \geq 4$  Temperley-Lieb representations could mean that they correspond to unbound entanglement unstable against state function reduction and preparation processes. Since

this kind of entanglement does not survive in quantum jump it is not representable in terms of braid groups.

2. Does  $r$  define a fractal dimension of  $CP_2$  projection of partonic 2-surface?

On basis of the quantum classical correspondence one expects that  $r$  should define some fractal dimension at the space-time level. Since  $r$  varies in the range  $1, \dots, 4$  and corresponds to the fractal dimension of 2-D Clifford algebra the corresponding spinors would have dimension  $d = \sqrt{r}$ . There are two options.

1.  $D = r/2$  is suggested on basis of the construction of quantum version of  $M^d$ .
2.  $D = \log_2(r)$  is natural on basis of the dimension  $d = 2^{D/2}$  of spinors in D-dimensional space.

$r$  can be assigned with  $CP_2$  degrees of freedom in the model for the quantization of Planck constant based on the explicit identification of Josephson inclusions in terms of finite subgroups of  $SU(2) \subset SU(3)$ . Hence  $D$  should relate to the  $CP_2$  projection of the partonic 2-surface and one could have  $D = D(X^2)$ , the latter being the average dimension of the  $CP_2$  projection of the partonic 2-surface for the preferred extremals of Kähler action.

Since a strongly interacting non-perturbative phase should be in question, the dimension for the  $CP_2$  projection of the space-time surface must be at least  $D(X^4) = 2$  to guarantee that non-vacuum extremals are in question. This is true for  $D(X^2) = r/2 \geq 1$ . The logarithmic formula  $D(X^2) = \log_2(r) \geq 0$  gives  $D(X^2) = 0$  for  $n = 3$  meaning that partonic 2-surfaces are vacua: space-time surface can still be a non-vacuum extremal.

As  $n$  increases, the number of  $CP_2$  points covering a given  $M^4$  point and related by the finite subgroup of  $G \subset SU(2) \subset SU(3)$  defining the inclusion increases so that the fractal dimension of the  $CP_2$  projection is expected to increase also.  $D(X^2) = 2$  would correspond to the space-time surfaces for which partons have topological magnetic charge forcing them to have a 2-dimensional  $CP_2$  projection. There are reasons to believe that the projection must be homologically non-trivial geodesic sphere of  $CP_2$ .

### 13.3.5 Could binding energy spectra reflect the hierarchy of effective tensor factor dimensions?

If one takes completely seriously the idea that join along boundaries bonds are a correlate of binding then the spectrum of binding energies might reveal the hierarchy of the fractal dimensions  $r(n)$ . Hydrogen atom and harmonic oscillator have become symbols for bound state systems. Hence it is of interest to find whether the binding energy spectrum of these systems might be expressed in terms of the "binding dimension"  $x(n) = 4 - r(n)$  characterizing the deviation of dimension from that at the limit of a vanishing binding energy. The binding energies of hydrogen atom are in a good approximation given by  $E(n)/E(1) = 1/n^2$  whereas in the case of harmonic oscillator one has  $E(n)/E_0 = 2n + 1$ . The constraint  $n \geq 3$  implies that the principal quantum number must correspond  $n - 2$  in the case of hydrogen atom and to  $n - 3$  in the case of harmonic oscillator.

Before continuing one must face an obvious objection. By previous arguments different values of  $r$  correspond to different values of  $\hbar$ . The value of  $\hbar$  cannot however differ for the states of hydrogen atom. This is certainly true. The objection however leaves open the possibility that the states of the light-like boundaries of join along boundaries bonds correspond to reflective level and represent some aspects of the physics of, say, hydrogen atom.

In the general case the energy spectrum satisfies the condition

$$\frac{E_B(n)}{E_B(3)} = \frac{f(4 - r(n))}{f(3)} \quad , \quad (13.3.3)$$

where  $f$  is some function. The simplest assumption is that the spectrum of binding energies  $E_B(n) = E(n) - E(\infty)$  is a linear function of  $r(n) - 4$ :

$$\frac{E_B(n)}{E_B(3)} = \frac{4 - r(n)}{3} = \frac{4}{3} \sin^2\left(\frac{\pi}{n}\right) \rightarrow \frac{4\pi^2}{3} \times \frac{1}{n^2} \quad . \quad (13.3.4)$$

In the linear approximation the ratio  $E(n+1)/E(n)$  approaches  $(n/n+1)^2$  as in the case of hydrogen atom but for small values the linear approximation fails badly. An exact correspondence results for

$$\frac{E(n)}{E(1)} = \frac{1}{n^2} ,$$

$$n = \frac{1}{\pi \arcsin(\sqrt{1-r(n+2)/4})} - 2 .$$

Also the ionized states with  $r \geq 4$  would correspond to bound states in the sense that two particles would be constrained to move in the same space-like section of space-time surface and should be distinguished from genuinely free states when particles correspond to disjoint space-time sheets.

For the harmonic oscillator one expresses  $E(n) - E(0)$  instead of  $E(n) - E(\infty)$  as a function of  $x = 4 - r$  and one would have

$$\frac{E(n)}{E(0)} = 2n + 1 ,$$

$$n = \frac{1}{\pi \arcsin(\sqrt{1-r(n+3)/4})} - 3 .$$

In this case ionized states would not be possible due to the infinite depth of the harmonic oscillator potential well.

### 13.3.6 Four-color problem, $\Pi_1$ factors, and anyons

The so called four-color problem can be phrased as a question whether it is possible to color the regions of a plane map using only four colors in such a manner that no adjacent regions have the same color (for an enjoyable discussion of the problem see [?]). One might call this kind of coloring complete. There is no loss of generality in assuming that the map can be represented as a graph with regions represented as triangle shaped faces of the graph. For the dual graph the coloring of faces becomes coloring of vertices and the question becomes whether the coloring is possible in such a manner that no vertices at the ends of the same edge have same color. The problem can be generalized by replacing planar maps with maps defined on any two-dimensional surface with or without boundary and arbitrary topology. The four-color problem has been solved with an extensive use of computer [?] but it would be nice to understand why the complete coloring with four colors is indeed possible.

There is a mysterious looking connection between four-color problem and the dimensions  $r(n) = 4\cos^2(\pi/n)$ , which are in fact known as Beraha numbers in honor of the discoverer of this connection [?]. Consider a more general problem of coloring two-dimensional map using  $m$  colors. One can construct a polynomial  $P(m)$ , so called chromatic polynomial, which tells the number of colorings satisfying the condition that no neighboring vertices have the same color. The vanishing of the chromatic polynomial for an integer value of  $m$  tells that the complete coloring using  $m$  colors is not possible.

$P(m)$  has also other than integer valued real roots. The strange discovery due to Beraha is that the numbers  $B(n)$  appear as approximate roots of the chromatic polynomial in many situations. For instance, the four non-integral real roots of the chromatic polynomial of the truncated icosahedron are very close to  $B(5)$ ,  $B(7)$ ,  $B(8)$  and  $B(9)$ . These findings led Beraha to formulate the following conjecture. Let  $P_i$  be a sequence of chromatic polynomials for a graph for which the number of vertices approaches infinity. If  $r_i$  is a root of the polynomial approaching a well-defined value at the limit  $i \rightarrow \infty$ , then the limiting value of  $r(i)$  is Beraha number.

A physicist's proof for Beraha's conjecture based on quantum groups and conformal theory has been proposed [?]. It is interesting to look for a possible physical interpretation of 4-color problem and Beraha's conjecture in TGD framework.

1. In TGD framework  $B(n)$  corresponds to a renormalized dimension for a 2-spin system consisting of two qubits, which corresponds to 4 different colors. For  $B(n) = 4$  two spin 1/2 fermions obeying Fermi statistics are in question. Since the system is 2-dimensional, the general case corresponds to two anyons with fractional spin  $B(n)/4$  giving rise to  $B(n) < 4$  colors and obeying fractional statistics instead of Fermi statistics. One can replace coloring problem with the problem whether an ideal antiferro-magnetic lattice using anyons with fractional spin  $B(n)/4$  is possible energetically. In other words, does this system form a quantum mechanical bound state even at the limit when the lengths of the edges approach to zero.

2. The failure of coloring means that there are at least two neighboring vertices in the lattice with the property that the spins at the ends of the same edge are in the same direction. Lattice defect would be in question. At the limit of an infinitesimally short edge length the failure of coloring is certainly not an energetically favored option for fermionic spins ( $m = 4$ ) but is allowed by anyonic statistics for  $m = B(n) < 4$ . Thus one has reasons to expect that when anyonic spin is  $B(n)/4$  the formation of a purely 2-anyon bound states becomes possible and they form at the limit of an infinitesimal edge length a kind of topological macroscopic quantum phase with a non-vanishing binding energy. That  $B(n)$  are roots of the chromatic polynomial at the continuum limit would have a clear physical interpretation.
3. Only  $B(n) < 4$  defines a sub-factor of von Neumann algebra allowing unitary Temperley-Lieb representations. This is consistent with the fact that for  $m = 4$  complete coloring must exist. The physical argument is that otherwise a macroscopic quantum phase with non-vanishing binding energy could result at the continuum limit and the upper bound for  $r$  from unitarity would be larger than 4. For  $m = 4$  the completely anti-ferromagnetic state would represent the ground state and the absence of anyon-pair condensate would mean a vanishing binding energy.

### 13.4 Inclusions of $II_1$ and $III_1$ factors

Inclusions  $\mathcal{N} \subset \mathcal{M}$  of von Neumann algebras have physical interpretation as a mathematical description for sub-system-system relation. For type  $I$  algebras the inclusions are trivial and tensor product description applies as such. For factors of  $II_1$  and  $III$  the inclusions are highly non-trivial. The inclusion of type  $II_1$  factors were understood by Vaughan Jones [?] and those of factors of type  $III$  by Alain Connes [?].

Sub-factor  $\mathcal{N}$  of  $\mathcal{M}$  is defined as a closed  $*$ -stable  $C$ -subalgebra of  $\mathcal{M}$ . Let  $\mathcal{N}$  be a sub-factor of type  $II_1$  factor  $\mathcal{M}$ . Jones index  $\mathcal{M} : \mathcal{N}$  for the inclusion  $\mathcal{N} \subset \mathcal{M}$  can be defined as  $\mathcal{M} : \mathcal{N} = \dim_{\mathcal{N}}(L^2(\mathcal{M})) = \text{Tr}_{\mathcal{N}'}(id_{L^2(\mathcal{M})})$ . One can say that the dimension of completion of  $\mathcal{M}$  as  $\mathcal{N}$  module is in question.

#### 13.4.1 Basic findings about inclusions

What makes the inclusions non-trivial is that the position of  $\mathcal{N}$  in  $\mathcal{M}$  matters. This position is characterized in case of hyper-finite  $II_1$  factors by index  $\mathcal{M} : \mathcal{N}$  which can be said to the dimension of  $\mathcal{M}$  as  $\mathcal{N}$  module and also as the inverse of the dimension defined by the trace of the projector from  $\mathcal{M}$  to  $\mathcal{N}$ . It is important to notice that  $\mathcal{M} : \mathcal{N}$  does not characterize either  $\mathcal{M}$  or  $\mathcal{N}$ , only the imbedding.

The basic facts proved by Jones are following [?].

1. For pairs  $\mathcal{N} \subset \mathcal{M}$  with a finite principal graph the values of  $\mathcal{M} : \mathcal{N}$  are given by

$$\begin{aligned}
 a) \quad \mathcal{M} : \mathcal{N} &= 4\cos^2(\pi/h) \quad , \quad h \geq 3 \quad , \\
 b) \quad \mathcal{M} : \mathcal{N} &\geq 4 \quad .
 \end{aligned}
 \tag{13.4.1}$$

the numbers at right hand side are known as Beraha numbers [?]. The comments below give a rough idea about what finiteness of principal graph means.

2. As explained in [?], for  $\mathcal{M} : \mathcal{N} < 4$  one can assign to the inclusion Dynkin graph of ADE type Lie-algebra  $g$  with  $h$  equal to the Coxeter number  $h$  of the Lie algebra given in terms of its dimension and dimension  $r$  of Cartan algebra  $r$  as  $h = (\dim g - r)/r$ . The Lie algebras of  $SU(n)$ ,  $E_7$  and  $D_{2n+1}$  are however not allowed. For  $\mathcal{M} : \mathcal{N} = 4$  one can assign to the inclusion an extended Dynkin graph of type ADE characterizing Kac Moody algebra. Extended ADE diagrams characterize also the subgroups of  $SU(2)$  and the interpretation proposed in [?] is following. The ADE diagrams are associated with the  $n = \infty$  case having  $\mathcal{M} : \mathcal{N} \geq 4$ . There are diagrams corresponding to infinite subgroups:  $SU(2)$  itself, circle group  $U(1)$ , and infinite dihedral groups (generated by a rotation by a non-rational angle and reflection. The diagrams

corresponding to finite subgroups are extension of  $A_n$  for cyclic groups, of  $D_n$  dihedral groups, and of  $E_n$  with  $n=6,7,8$  for tetrahedron, cube, dodecahedron. For  $\mathcal{M} : \mathcal{N} < 4$  ordinary Dynkin graphs of  $D_{2n}$  and  $E_6, E_8$  are allowed.

The interpretation of [?] is that the subfactors correspond to inclusions  $\mathcal{N} \subset \mathcal{M}$  defined in the following manner.

1. Let  $G$  be a finite subgroup of  $SU(2)$ . Denote by  $R$  the infinite-dimensional Clifford algebras resulting from infinite-dimensional tensor power of  $M_2(C)$  and by  $R_0$  its subalgebra obtained by restricting  $M_2(C)$  element of the first factor to be unit matrix. Let  $G$  act by automorphisms in each tensor factor.  $G$  leaves  $R_0$  invariant. Denote by  $R_0^G$  and  $R^G$  the sub-algebras which remain element wise invariant under the action of  $G$ . The resulting Jones inclusions  $R_0^G \subset R^G$  are consistent with the ADE correspondence.
2. The argument suggests the existence of quantum versions of subgroups of  $SU(2)$  for which representations are truncations of those for ordinary subgroups. The results have been generalized to other Lie groups.
3. Also  $SL(2, C)$  acts as automorphisms of  $M_2(C)$ . An interesting question is what happens if one allows  $G$  to be any discrete subgroups of  $SL(2, C)$ . Could this give inclusions with  $\mathcal{M} : \mathcal{N} > 4$ ?. The strong analogy of the spectrum of indices with spectrum of energies with hydrogen atom would encourage this interpretation: the subgroup  $SL(2, C)$  not reducing to those of  $SU(2)$  would correspond to the possibility for the particle to move with respect to each other with constant velocity.

### 13.4.2 The fundamental construction and Temperley-Lieb algebras

It was shown by Jones [?] that for a given Jones inclusion with  $\beta = \mathcal{M} : \mathcal{N} < \infty$  there exists a tower of finite  $II_1$  factors  $\mathcal{M}_k$  for  $k = 0, 1, 2, \dots$  such that

1.  $\mathcal{M}_0 = \mathcal{N}, \mathcal{M}_1 = \mathcal{M}$ ,
2.  $\mathcal{M}_{k+1} = \text{End}_{\mathcal{M}_{k-1}} \mathcal{M}_k$  is the von Neumann algebra of operators on  $L^2(\mathcal{M}_k)$  generated by  $\mathcal{M}_k$  and an orthogonal projection  $e_k : L^2(\mathcal{M}_k) \rightarrow L^2(\mathcal{M}_{k-1})$  for  $k \geq 1$ , where  $\mathcal{M}_k$  is regarded as a subalgebra of  $\mathcal{M}_{k+1}$  under right multiplication.

It can be shown that  $\mathcal{M}_{k+1}$  is a finite factor. The sequence of projections on  $\mathcal{M}_\infty = \cup_{k \geq 0} \mathcal{M}_k$  satisfies the relations

$$\begin{aligned}
 e_i^2 &= e_i, & e_i^- e_i &, \\
 e_i &= \beta e_i e_j e_i & \text{for } |i - j| &= 1, \\
 e_i e_j &= e_j e_i & \text{for } |i - j| &\geq 2.
 \end{aligned}
 \tag{13.4.2}$$

The construction of hyper-finite  $II_1$  factor using Clifford algebra  $C(2)$  represented by  $2 \times 2$  matrices allows to understand the theorem in  $\beta = 4$  case in a straightforward manner. In particular, the second formula involving  $\beta$  follows from the identification of  $x$  at  $(k - 1)^{th}$  level with  $(1/\beta) \text{diag}(x, x)$  at  $k^{th}$  level.

By replacing  $2 \times 2$  matrices with  $\sqrt{\beta} \times \sqrt{\beta}$  matrices one can understand heuristically what is involved in the more general case.  $\mathcal{M}_k$  is  $\mathcal{M}_{k-1}$  module with dimension  $\sqrt{\beta}$  and  $\mathcal{M}_{k+1}$  is the space of  $\sqrt{\beta} \times \sqrt{\beta}$  matrices  $\mathcal{M}_{k-1}$  valued entries acting in  $\mathcal{M}_k$ . The transition from  $\mathcal{M}_k$  to  $\mathcal{M}_{k-1}$  linear maps of  $\mathcal{M}_k$  happens in the transition to the next level.  $x$  at  $(k - 1)^{th}$  level is identified as  $(x/\beta) \times \text{Id}_{\sqrt{\beta} \times \sqrt{\beta}}$  at the next level. The projection  $e_k$  picks up the projection of the matrix with  $\mathcal{M}_{k-1}$  valued entries in the direction of the  $\text{Id}_{\sqrt{\beta} \times \sqrt{\beta}}$ .

The union of algebras  $A_{\beta, k}$  generated by  $1, e_1, \dots, e_k$  defines Temperley-Lieb algebra  $A_\beta$  [?]. This algebra is naturally associated with braids. Addition of one strand to a braid adds one generator to this algebra and the representations of the Temperley Lieb algebra provide link, knot, and 3-manifold invariants [?]. There is also a connection with systems of statistical physics and with Yang-Baxter algebras [?].

A further interesting fact about the inclusion hierarchy is that the elements in  $\mathcal{M}_i$  belonging to the commutator  $\mathcal{N}'$  of  $\mathcal{N}$  form finite-dimensional spaces. Presumably the dimension approaches infinity for  $n \rightarrow \infty$ .



### 13.4.3 Connection with Dynkin diagrams

The possibility to assign Dynkin diagrams ( $\beta < 4$ ) and extended Dynkin diagrams ( $\beta = 4$  to Jones inclusions can be understood heuristically by considering a characterization of so called bipartite graphs [?] , [?] by the norm of the adjacency matrix of the graph.

Bipartite graphs  $\Gamma$  is a finite, connected graph with multiple edges and black and white vertices such that any edge connects white and black vertex and starts from a white one. Denote by  $w(\Gamma)$  ( $b(\Gamma)$ ) the number of white (black) vertices. Define the adjacency matrix  $\Lambda = \Lambda(\Gamma)$  of size  $b(\Gamma) \times w(\Gamma)$  by

$$w_{b,w} = \begin{cases} m(e) & \text{if there exists } e \text{ such that } \delta e = b - w \text{ ,} \\ 0 & \text{otherwise .} \end{cases} \tag{13.4.3}$$

Here  $m(e)$  is the multiplicity of the edge  $e$ .

Define norm  $\|\Gamma\|$  as

$$\begin{aligned} \|X\| &= \max\{\|X\|; \|x\| \leq 1\} \text{ ,} \\ \|\Gamma\| &= \|\Lambda(\Gamma)\| = \left\| \begin{array}{cc} 0 & \Lambda(\Gamma) \\ \Lambda(\Gamma)^t & 0 \end{array} \right\| \text{ .} \end{aligned} \tag{13.4.4}$$

Note that the matrix appearing in the formula is  $(m+n) \times (m+n)$  symmetric square matrix so that the norm is the eigenvalue with largest absolute value.

Suppose that  $\Gamma$  is a connected finite graph with multiple edges (sequences of edges are regarded as edges). Then

1. If  $\|\Gamma\| \leq 2$  and if  $\Gamma$  has a multiple edge,  $\|\Gamma\| = 2$  and  $\Gamma = \tilde{A}_1$ , the extended Dynkin diagram for  $SU(2)$  Kac Moody algebra.
2.  $\|\Gamma\| < 2$  if and only if  $\Gamma$  is one of the Dynkin diagrams of A,D,E. In this case  $\|\Gamma\| = 2\cos(\pi/h)$ , where  $h$  is the Coxeter number of  $\Gamma$ .
3.  $\|\Gamma\| = 2$  if and only if  $\Gamma$  is one of the extended Dynkin diagrams  $\tilde{A}, \tilde{D}, \tilde{E}$ .

This result suggests that one can indeed assign to the Jones inclusions Dynkin diagrams. To really understand how the inclusions can be characterized in terms bipartite diagrams would require a deeper understanding of von Neumann algebras. The following argument only demonstrates that bipartite graphs naturally describe inclusions of algebras.

1. Consider a bipartite graph. Assign to each white vertex linear space  $W(w)$  and to each edge of a linear space  $W(b, w)$ . Assign to a given black vertex the vector space  $\oplus_{\delta e=b-w} W(b, w) \otimes W(w)$  where  $(b, w)$  corresponds to an edge ending to  $b$ .
2. Define  $\mathcal{N}$  as the direct sum of algebras  $End(W(w))$  associated with white vertices and  $\mathcal{M}$  as direct sum of algebras  $\oplus_{\delta e=b-w} End(W(b, w)) \otimes End(W(w))$  associated with black vertices.
3. There is homomorphism  $N \rightarrow M$  defined by imbedding direct sum of white endomorphisms  $x$  to direct sum of tensor products  $x$  with the identity endomorphisms associated with the edges starting from  $x$ .

It is possible to show that Jones inclusions correspond to the Dynkin diagrams of  $A_n, D_{2n}$ , and  $E_6, E_8$  and extended Dynkin diagrams of ADE type. In particular, the dual of the bi-partite graph associated with  $\mathcal{M}_{n-1} \subset \mathcal{M}_n$  obtained by exchanging the roles of white and black vertices describes the inclusion  $\mathcal{M}_n \subset \mathcal{M}_{n+1}$  so that two subsequent Jones inclusions might define something fundamental (the corresponding space-time dimension is  $2 \times \log_2(\mathcal{M} : \mathcal{N}) \leq 4$ ).

### 13.4.4 Indices for the inclusions of type $III_1$ factors

Type  $III_1$  factors appear in relativistic quantum field theory defined in 4-dimensional Minkowski space [?] . An overall summary of basic results discovered in algebraic quantum field theory is described in the lectures of Longo [?] . In this case the inclusions for algebras of observables are induced by the inclusions for bounded regions of  $M^4$  in axiomatic quantum field theory. Tomita's theory of modular Hilbert algebras [?] , [?] forms the mathematical corner stone of the theory.

The basic notion is Haag-Kastler net [?] consisting of bounded regions of  $M^4$ . Double cone serves as a representative example. The von Neumann algebra  $\mathcal{A}(O)$  is generated by observables localized in bounded region  $O$ . The net satisfies the conditions implied by local causality:

1. Isotony:  $O_1 \subset O_2$  implies  $\mathcal{A}(O_1) \subset \mathcal{A}(O_2)$ .
2. Locality:  $O_1 \subset O'_2$  implies  $\mathcal{A}(O_1) \subset \mathcal{A}(O'_2)'$  with  $O'$  defined as  $\{x : \langle x, y \rangle < 0 \text{ for all } y \in O\}$ .
3. Haag duality  $\mathcal{A}(O')' = \mathcal{A}(O)$ .

Besides this Poincare covariance, positive energy condition, and the existence of vacuum state is assumed.

DHR (Doplicher-Haag-Roberts) [?] theory allows to deduce the values of Jones index and they are squares of integers in dimensions  $D > 2$  so that the situation is rather trivial. The 2-dimensional case is distinguished from higher dimensional situations in that braid group replaces permutation group since the paths representing the flows permuting identical particles can be linked in  $X^2 \times T$  and anyonic statistics [D23, D21] becomes possible. In the case of 2-D Minkowski space  $M^2$  Jones inclusions with  $\mathcal{M} : \mathcal{N} < 4$  plus a set of discrete values of  $\mathcal{M} : \mathcal{N}$  in the range (4, 6) are possible. In [?] some values are given ( $\mathcal{M} : \mathcal{N} = 5, 5.5049\dots, 5.236\dots, 5.828\dots$ ).

At least intersections of future and past light cones seem to appear naturally in TGD framework such that the boundaries of future/past directed light cones serve as seats for incoming/outgoing states defined as intersections of space-time surface with these light cones.  $III_1$  sectors cannot thus be excluded as factors in TGD framework. On the other hand, the construction of S-matrix at space-time level is reduced to  $II_1$  case by effective 2-dimensionality.

## 13.5 TGD and hyper-finite factors of type $II_1$ : ideas and questions

By effective 2-dimensionality of the construction of quantum states the hyper-finite factors of type  $II_1$  fit naturally to TGD framework. In particular, infinite dimensional spinors define a canonical representations of this kind of factor. The basic question is whether only hyper-finite factors of type  $II_1$  appear in TGD framework. Affirmative answer would allow to interpret physical  $M$ -matrix as time like entanglement coefficients.

### 13.5.1 What kind of hyper-finite factors one can imagine in TGD?

The working hypothesis has been that only hyper-finite factors of type  $II_1$  appear in TGD. The basic motivation has been that they allow a new view about  $M$ -matrix as an operator representable as time-like entanglement coefficients of zero energy states so that physical states would represent laws of physics in their structure. They allow also the introduction of the notion of measurement resolution directly to the definition of reaction probabilities by using Jones inclusion and the replacement of state space with a finite-dimensional state space defined by quantum spinors. This hypothesis is of course just an attractive working hypothesis and deserves to be challenged.

#### Configuration space spinors

For configuration space spinors the HFF  $II_1$  property is very natural because of the properties of infinite-dimensional Clifford algebra and the inner product defined by the configuration space geometry does not allow other factors than this. A good guess is that the values of conformal weights label the factors appearing in the tensor power defining configuration space spinors. Because of

the non-degeneracy and super-symplectic symmetries the density matrix representing metric must be essentially unit matrix for each conformal weight which would be the defining characteristic of hyper-finite factor of type  $II_1$ .

### Bosonic degrees of freedom

The bosonic part of the super-symplectic algebra consists of Hamiltonians of  $CH$  in one-one correspondence with those of  $\delta M_{\pm}^4 \times CP_2$ . Also the Kac-Moody algebra acting leaving the light-likeness of the partonic 3-surfaces intact contributes to the bosonic degrees of freedom. The commutator of these algebras annihilates physical states and there are also Virasoro conditions associated with ordinary conformal symmetries of partonic 2-surface [?] . The labels of Hamiltonians of configuration space and spin indices contribute to bosonic degrees of freedom.

Hyper-finite factors of type  $II_1$  result naturally if the system is an infinite tensor product finite-dimensional matrix algebra associated with finite dimensional systems [?] . Unfortunately, neither Virasoro, symplectic nor Kac-Moody algebras do have decomposition into this kind of infinite tensor product. If bosonic degrees for super-symplectic and super-Kac Moody algebra indeed give  $I_{\infty}$  factor one has HFF of type  $II_{\infty}$ . This looks the most natural option but threatens to spoil the beautiful idea about  $M$ -matrix as time-like entanglement coefficients between positive and negative energy parts of zero energy state.

The resolution of the problem is surprisingly simple and trivial after one has discovered it. The requirement that state is normalizable forces to project  $M$ -matrix to a finite-dimensional sub-space in bosonic degrees of freedom so that the reduction  $I_{\infty} \rightarrow I_n$  occurs and one has the reduction  $II_{\infty} \rightarrow II_1 \times I_n = II_1$  to the desired HFF.

One can consider also the possibility of taking the limit  $n \rightarrow \infty$ . One could indeed say that since  $I_{\infty}$  factor can be mapped to an infinite tensor power of  $M(2, C)$  characterized by a state which is not trace, it is possible to map this representation to HFF by replacing state with trace [?] . The question is whether the forcing the bosonic foot to fermionic shoe is physically natural. One could also regard the  $II_1$  type notion of probability as fundamental and also argue that it is required by full super-symmetry realized also at the level of many-particle states rather than mere single particle states.

### How the bosonic cutoff is realized?

Normalizability of state requires that projection to a finite-dimensional bosonic sub-space is carried out for the bosonic part of the  $M$ -matrix. This requires a cutoff in quantum numbers of super-conformal algebras. The cutoff for the values of conformal weight could be formulated by replacing integers with  $Z_n$  or with some finite field  $G(p, 1)$ . The cutoff for the labels associated with Hamiltonians defined as an upper bound for the dimension of the representation looks also natural.

Number theoretical braids which are discrete and finite structures would define space-time correlate for this cutoff. p-Adic length scale  $p \simeq 2^k$  hypothesis could be interpreted as stating the fact that only powers of  $p$  up to  $p^k$  are significant in p-adic thermodynamics which would correspond to finite field  $G(k, 1)$  if  $k$  is prime. This has no consequences for p-adic mass calculations since already the first two terms give practically exact results for the large primes associated with elementary particles [K45] .

Finite number of strands for the theoretical braids would serve as a correlate for the reduction of the representation of Galois group  $S_{\infty}$  of rationals to an infinite produce of diagonal copies of finite-dimensional Galois group so that same braid would repeat itself like a unit cell of lattice i condensed matter [?] .

### HFF of type $III$ for field operators and HFF of type $II_1$ for states?

One could also argue that the Hamiltonians with fixed conformal weight are included in fermionic  $II_1$  factor and bosonic factor  $I_{\infty}$  factor, and that the inclusion of conformal weights leads to a factor of type  $III$ . Conformal weight could relate to the integer appearing in the crossed product representation  $III = Z \times_{cr} II_{\infty}$  of HFF of type  $III$  [?] .

The value of conformal weight is non-negative for physical states which suggests that  $Z$  reduces to semigroup  $N$  so that a factor of type  $III$  would reduce to a factor of type  $II_{\infty}$  since trace would become finite. If unitary process corresponds to an automorphism for  $II_{\infty}$  factor, the action of automorphisms affecting scaling must be uni-directional. Also thermodynamical irreversibility suggests the same. The

assumption that state function reduction for positive energy part of state implies unitary process for negative energy state and vice versa would only mean that the shifts for positive and negative energy parts of state are opposite so that  $Z \rightarrow N$  reduction would still hold true.

### HFF of type $II_1$ for the maxima of Kähler function?

Probabilistic interpretation allows to gain heuristic insights about whether and how hyper-finite factors of type  $II_1$  might be associated with configuration space degrees of freedom. They can appear both in quantum fluctuating degrees of freedom associated with a given maximum of Kähler function and in the discrete space of maxima of Kähler function.

Spin glass degeneracy is the basic prediction of classical TGD and means that instead of a single maximum of Kähler function analogous to single free energy minimum of a thermodynamical system there is a fractal spin glass energy landscape with valleys inside valleys. The discretization of the configuration space in terms of the maxima of Kähler function crucial for the p-adicization problem, leads to the analog of spin glass energy landscape and hyper-finite factor of type  $II_1$  might be the appropriate description of the situation.

The presence of the tensor product structure is a powerful additional constraint and something analogous to this should emerge in configuration space degrees of freedom. Fractality of the many-sheeted space-time is a natural candidate here since the decomposition of the original geometric structure to parts and replacing them with the scaled down variant of original structure is the geometric analog of forming a tensor power of the original structure.

### 13.5.2 Direct sum of HFFs of type $II_1$ as a minimal option

HFF  $II_1$  property for the Clifford algebra of the configuration space means a definite distinction from the ordinary Clifford algebra defined by the fermionic oscillator operators since the trace of the unit matrix of the Clifford algebra is normalized to one. This does not affect the anti-commutation relations at the basic level and delta functions can appear in them at space-time level. At the level of momentum space  $I_\infty$  property requires discrete basis and anti-commutators involve only Kronecker deltas. This conforms with the fact that HFF of type  $II_1$  can be identified as the Clifford algebra associated with a separable Hilbert space.

#### $II_\infty$ factor or direct sum of HFFs of type $II_1$ ?

The expectation is that super-symplectic algebra is a direct sum over HFFs of type  $II_1$  labeled by the radial conformal weight. In the same manner the algebra defined by fermionic anti-commutation relations at partonic 2-surface would decompose to a direct sum of algebras labeled by the conformal weight associated with the light-like coordinate of  $X_l^3$ . Super-conformal symmetry suggests that also the configuration space degrees of freedom correspond to a direct sum of HFFs of type  $II_1$ .

One can of course ask why not  $II_\infty = I_\infty \times II_1$  structures so that one would have single factor rather than a direct sum of factors.

1. The physical motivation is that the direct sum property allow to decompose M-matrix to direct summands associated with various sectors with weights whose moduli squared have an interpretation in terms of the density matrix. This is also consistent with p-adic thermodynamics where conformal weights take the place of energy eigen values.
2.  $II_\infty$  property would predict automorphisms scaling the trace by an arbitrary positive real number  $\lambda \in R_+$ . These automorphisms would require the scaling of the trace of the projectors of Clifford algebra having values in the range  $[0, 1]$  and it is difficult to imagine how these automorphisms could be realized geometrically.

#### How HFF property reflects itself in the construction of geometry of WCW?

The interesting question is what HFF property and finite measurement resolution realizing itself as the use of projection operators means concretely at the level of the configuration space geometry.

Super-Hamiltonians define the Clifford algebra of the configuration space. Super-conformal symmetry suggests that the unavoidable restriction to projection operators instead of complex rays is

realized also configuration space degrees of freedom. Of course, infinite precision in the determination of the shape of 3-surface would be physically a completely unrealistic idea.

In the fermionic situation the anti-commutators for the gamma matrices associated with configuration space individual Hamiltonians in 3-D sense are replaced with anti-commutators where Hamiltonians are replaced with projectors to subspaces of the space spanned by Hamiltonians. This projection is realized by restricting the anti-commutator to partonic 2-surfaces so that the anti-commutator depends only the restriction of the Hamiltonian to those surfaces.

What is interesting that the measurement resolution has a concrete particle physical meaning since the parton content of the system characterizes the projection. The larger the number of partons, the better the resolution about configuration space degrees of freedom is. The degeneracy of configuration space metric would be interpreted in terms of finite measurement resolution inherent to HFFs of type  $II_1$ , which is not due to Jones inclusions but due to the fact that one can project only to infinite-D subspaces rather than complex rays.

Effective 2-dimensionality in the sense that configuration space Hamiltonians reduce to functionals of the partonic 2-surfaces of  $X_l^3$  rather than functionals of  $X_l^3$  could be interpreted in this manner. For a wide class of Hamiltonians actually effective 1-dimensionality holds true in accordance with conformal invariance.

The generalization of configuration space Hamiltonians and super-Hamiltonians by allowing integrals over the 2-D boundaries of the patches of  $X_l^3$  would be natural and is suggested by the requirement of discretized 3-dimensionality at the level of configuration space.

By quantum classical correspondence the inclusions of HFFs related to the measurement resolution should also have a geometric description. Measurement resolution corresponds to braids in given time scale and as already explained there is a hierarchy of braids in time scales coming as negative powers of two corresponding to the addition of zero energy components to positive/negative energy state. Note however that particle reactions understood as decays and fusions of braid strands could also lead to a notion of measurement resolution.

### 13.5.3 Bott periodicity, its generalization, and dimension $D = 8$ as an inherent property of the hyper-finite $II_1$ factor

Hyper-finite  $II_1$  factor can be constructed as infinite-dimensional tensor power of the Clifford algebra  $M_2(C) = C(2)$  in dimension  $D = 2$ . More precisely, one forms the union of the Clifford algebras  $C(2n) = C(2)^{\otimes n}$  of  $2n$ -dimensional spaces by identifying the element  $x \in C(2n)$  as block diagonal elements  $\text{diag}(x, x)$  of  $C(2(n+1))$ . The union of these algebras is completed in weak operator topology and can be regarded as a Clifford algebra of real infinite-dimensional separable Hilbert space and thus as sub-algebra of  $I_\infty$ . Also generalizations obtained by replacing complex numbers by quaternions and octonions are possible.

1. The dimension 8 is an inherent property of the hyper-finite  $II_1$  factor since Bott periodicity theorem states  $C(n+8) = C_n(16)$ . In other words, the Clifford algebra  $C(n+8)$  is equivalent with the algebra of  $16 \times 16$  matrices with entries in  $C(n)$ . Or articulating it still differently:  $C(n+8)$  can be regarded as  $16 \times 16$  dimensional module with  $C(n)$  valued coefficients. Hence the elements in the union defining the canonical representation of hyper-finite  $II_1$  factor are  $16^n \times 16^n$  matrices having  $C(0)$ ,  $C(2)$ ,  $C(4)$  or  $C(6)$  valued elements.
2. The idea about a local variant of the infinite-dimensional Clifford algebra defined by power series of space-time coordinate with Taylor coefficients which are Clifford algebra elements fixes the interpretation. The representation as a linear combination of the generators of Clifford algebra of the finite-dimensional space allows quantum generalization only in the case of Minkowski spaces. However, if Clifford algebra generators are representable as gamma matrices, the powers of coordinate can be absorbed to the Clifford algebra and the local algebra is lost. Only if the generators are represented as quantum versions of octonions allowing no matrix representation because of their non-associativity, the local algebra makes sense. From this it is easy to deduce both quantum and classical TGD.

### 13.5.4 The interpretation of Jones inclusions in TGD framework

By the basic self-referential property of von Neumann algebras one can consider several interpretations of Jones inclusions consistent with sub-system-system relationship, and it is better to start by considering the options that one can imagine.

#### How Jones inclusions relate to the new view about sub-system?

Jones inclusion characterizes the imbedding of sub-system  $\mathcal{N}$  to  $\mathcal{M}$  and  $\mathcal{M}$  as a finite-dimensional  $\mathcal{N}$ -module is the counterpart for the tensor product in finite-dimensional context. The possibility to express  $\mathcal{M}$  as  $\mathcal{N}$  module  $\mathcal{M}/\mathcal{N}$  states fractality and can be regarded as a kind of self-referential "Brahman=Atman identity" at the level of infinite-dimensional systems.

Also the mysterious looking almost identity  $CH^2 = CH$  for the configuration space of 3-surfaces would fit nicely with the identity  $M \oplus M = M$ .  $M \otimes M \subset M$  in configuration space Clifford algebra degrees of freedom is also implied and the construction of  $\mathcal{M}$  as a union of tensor powers of  $C(2)$  suggests that  $M \otimes M$  allows  $\mathcal{M} : \mathcal{N} = 4$  inclusion to  $\mathcal{M}$ . This paradoxical result conforms with the strange self-referential property of factors of  $II_1$ .

The notion of many-sheeted space-time forces a considerable generalization of the notion of sub-system and simple tensor product description is not enough. Topological picture based on the length scale resolution suggests even the possibility of entanglement between sub-systems of un-entangled sub-systems. The possibility that hyper-finite  $II_1$ -factors describe the physics of TGD also in bosonic degrees of freedom is suggested by configuration space super-symmetry. On the other hand, bosonic degrees could naturally correspond to  $I_\infty$  factor so that hyper-finite  $II_\infty$  would be the net result.

The most general view is that Jones inclusion describes all kinds of sub-system-system inclusions. The possibility to assign conformal field theory to the inclusion gives hopes of rather detailed view about dynamics of inclusion.

1. The topological condensation of space-time sheet to a larger space-time sheet mediated by worm-hole contacts could be regarded as Jones inclusion.  $\mathcal{N}$  would correspond to the condensing space-time sheet,  $\mathcal{M}$  to the system consisting of both space-time sheets, and  $\sqrt{\mathcal{M}} : \mathcal{N}$  would characterize the number of quantum spinorial degrees of freedom associated with the interaction between space-time sheets. Note that by general results  $\mathcal{M} : \mathcal{N}$  characterizes the fractal dimension of quantum group ( $\mathcal{M} : \mathcal{N} < 4$ ) or Kac-Moody algebra ( $\mathcal{M} : \mathcal{N} = 4$ ) [?].
2. The branchings of space-time sheets (space-time surface is thus homologically like branching like of Feynman diagram) correspond naturally to n-particle vertices in TGD framework. What is nice is that vertices are nice 2-dimensional surfaces rather than surfaces having typically pinch singularities. Jones inclusion would naturally appear as inclusion of operator spaces  $\mathcal{N}_i$  (essentially Fock spaces for fermionic oscillator operators) creating states at various lines as sub-spaces  $N_i \subset M$  of operators creating states in common von Neumann factor  $\mathcal{M}$ . This would allow to construct vertices and vertices in natural manner using quantum groups or Kac-Moody algebras.

The fundamental  $\mathcal{N} \subset \mathcal{M} \subset \mathcal{M} \otimes_{\mathcal{N}} \mathcal{M}$  inclusion suggests a concrete representation based on the identification  $N_i = M$ , where  $M$  is the universal Clifford algebra associated with incoming line and  $\mathcal{N}$  is defined by the condition that  $\mathcal{M}/\mathcal{N}$  is the quantum variant of Clifford algebra of  $H$ .  $N$ -particle vertices could be defined as traces of Connes products of the operators creating incoming and outgoing states. It will be found that this leads to a master formula for S-matrix if the generalization of the old-fashioned string model duality implying that all generalized Feynman diagrams reduce to diagrams involving only single vertex is accepted.

3. If 4-surfaces can branch as the construction of vertices requires, it is difficult to argue that 3-surfaces and partonic/stringy 2-surfaces could not do the same. As a matter fact, the master formula for S-matrix to be discussed later explains the branching of 4-surfaces as an apparent affect. Despite this one can consider the possibility that this kind of joins are possible so that a new kind of mechanism of topological condensation would become possible. 3-space-sheets and partonic 2-surfaces whose p-adic fractality is characterized by different p-adic primes could be connected by "joins" representing branchings of 2-surfaces. The structures formed by soap film foam provide a very concrete illustration about what would happen. In the TGD based model

of hadrons [K46] it has been assumed that join along boundaries bonds (JABs) connect quark space-time sheets to the hadronic space-time sheet. The problem is that, at least for identical primes, the formation of join along boundaries bond fuses two systems to single bound state. If JABs are replaced joins, this objection is circumvented.

4. The space-time correlate for the formation of bound states is the formation of JABs. Standard intuition tells that the number of degrees of freedom associated with the bound state is smaller than the number of degrees of freedom associated with the pair of free systems. Hence the inclusion of the bound state to the tensor product could be regarded as Jones inclusion. On the other hand, one could argue that the JABs carry additional vibrational degrees of freedom so that the idea about reduction of degrees of freedom might be wrong: free system could be regarded as sub-system of bound state by Jones inclusion. The self-referential holographic properties of von Neumann algebras allow both interpretations: any system can be regarded as sub-system of any system in accordance with the bootstrap idea.
5. Maximal deterministic regions inside given space-time sheet bounded by light-like causal determinants define also sub-systems in a natural manner and also their inclusions would naturally correspond to Jones inclusions.
6. The TGD inspired model for topological quantum computation involves the magnetic flux tubes defined by join along boundaries bonds connecting space-time sheets having light-like boundaries. These tubes condensed to background 3-space can become linked and knotted and code for quantum computations in this manner. In this case the addition of new strand to the system corresponds to Jones inclusion in the hierarchy associated with inclusion  $\mathcal{N} \subset \mathcal{M}$ . The anyon states associated with strands would be represented by a finite tensor product of quantum spinors assignable to  $\mathcal{M}/\mathcal{N}$  and representing quantum counterpart of  $H$ -spinors.

One can regard  $\mathcal{M} : \mathcal{N}$  degrees of freedom correspond to quantum group or Kac-Moody degrees of freedom. Quantum group degrees of freedom relate closely to the conformal and topological degrees of freedom as the connection of II<sub>1</sub> factors with topological quantum field theories and braid matrices suggests itself. For the canonical inclusion this factorization would correspond to factorization of quantum  $H$ -spinor from configuration space spinor.

A more detailed study of canonical inclusions to be carried out later demonstrates what this factorization corresponds at the space-time level to a formation of space-time sheets which can be regarded as multiple coverings of  $M^4$  and  $CP_2$  with invariance group  $G = G_a \times G_b \subset SL(2, C) \times SU(2)$ ,  $SU(2) \subset SU(3)$ . The unexpected outcome is that Planck constants assignable to  $M^4$  and  $CP_2$  degrees of freedom depend on the canonical inclusions. The existence of macroscopic quantum phases with arbitrarily large Planck constants is predicted.

It would seem possible to assign the  $\mathcal{M} : \mathcal{N}$  degrees quantum spinorial degrees of freedom to the interface between subsystems represented by  $\mathcal{N}$  and  $\mathcal{M}$ . The interface could correspond to the worm-hole contacts, joins, JABs, or light-like causal determinants serving as boundary between maximal deterministic regions, etc... In terms of the bipartite diagrams representing the inclusions, joins (say) would correspond to the edges connecting white vertices representing sub-system (the entire system without the joins) to black vertices (entire system).

### About the interpretation of $\mathcal{M} : \mathcal{N}$ degrees of freedom

The Clifford algebra  $\mathcal{N}$  associated with a system formed by two space-time sheet can be regarded as  $1 \leq \mathcal{M} : \mathcal{N} \leq 4$ -dimensional module having  $\mathcal{N}$  as its coefficients. It is possible to imagine several interpretations the degrees of freedom labeled by  $\beta$ .

1. The  $\beta = \mathcal{M} : \mathcal{N}$  degrees of freedom could relate to the interaction of the space-time sheets. Beraha numbers appear in the construction of S-matrices of topological quantum field theories and an interpretation in terms of braids is possible. This would suggest that the interaction between space-time sheets can be described in terms of conformal quantum field theory and the S-matrices associated with braids describe this interaction. Jones inclusions would characterize the effective number of active conformal degrees of freedom. At  $n = 3$  limit these degrees of freedom disappear completely since the conformal field theory defined by the Chern-Simons action describing this interaction would become trivial ( $c = 0$  as will be found).

2. The interpretation in terms of imbedding space Clifford algebra would suggest that  $\beta$ -dimensional Clifford algebra of  $\sqrt{\beta}$ -dimensional spinor space is in question. For  $\beta = 4$  the algebra would be the Clifford algebra of 2-dimensional space.  $\mathcal{M}/\mathcal{N}$  would have interpretation as complex quantum spinors with components satisfying  $z_1 z_2 = q z_2 z_1$  and its conjugate and having fractal complex dimension  $\sqrt{\beta}$ . This would conform with the effective 2-dimensionality of TGD. For  $\beta < 4$  the fractal dimension of partonic quantum spinors defining the basic conformal fields would be reduced and become  $d = 1$  for  $n = 3$ : the interpretation is in terms of strong correlations caused by the non-commutativity of the components of quantum spinor. For number theoretical generalizations of infinite-dimensional Clifford algebras  $Cl(C)$  obtained by replacing  $C$  with Abelian complexification of quaternions or octonions one would obtain higher-dimensional spinors.

### 13.5.5 Configuration space, space-time, and imbedding space and hyper-finite type $II_1$ factors

The preceding considerations have by-passed the question about the relationship of the configuration space tangent space to its Clifford algebra. Also the relationship between space-time and imbedding space and their quantum variants could be better. In particular, one should understand how effective 2-dimensionality can be consistent with the 4-dimensionality of space-time.

#### Super-conformal symmetry and configuration space Poisson algebra as hyper-finite type $II_1$ factor

It would be highly desirable to achieve also a description of the configuration space degrees of freedom using von Neumann algebras. Super-conformal symmetry relating fermionic degrees of freedom and configuration space degrees of freedom suggests that this might be the case. Super-symplectic algebra has as its generators configuration space Hamiltonians and their super-counterparts identifiable as  $CH$  gamma matrices. Super-symmetry requires that the Clifford algebra of  $CH$  and the Hamiltonian vector fields of  $CH$  with symplectic central extension both define hyper-finite  $II_1$  factors. By super-symmetry Poisson bracket corresponds to an anti-commutator for gamma matrices. The ordinary quantized version of Poisson bracket is obtained as  $\{P_i, Q_j\} \rightarrow [P_i, Q_j] = J_{ij} Id$ . Finite trace version results by assuming that  $Id$  corresponds to the projector  $CH$  Clifford algebra having unit norm. The presence of zero modes means direct integral over these factors.

Configuration space gamma matrices anti-commuting to identity operator with unit norm corresponds to the tangent space  $T(CH)$  of  $CH$ . Thus it would not be surprising if  $T(CH)$  could be imbedded in the sigma matrix algebra as a sub-space of operators defined by the gamma matrices generating this algebra. At least for  $\beta = 4$  construction of hyper-finite  $II_1$  factor this definitely makes sense.

The dimension of the configuration space defined as the trace of the projection operator to the sub-space spanned by gamma matrices is obviously zero. Thus configuration space has in this sense the dimensionality of single space-time point. This sounds perhaps absurd but the generalization of the number concept implied by infinite primes indeed leads to the view that single space-time point is infinitely structured in the number theoretical sense although in the real sense all states of the point are equivalent. The reason is that there is infinitely many numbers expressible as ratios of infinite integers having unit real norm in the real sense but having different p-adic norms.

#### How to understand the dimensions of space-time and imbedding space?

One should be able to understand the dimensions of 3-space, space-time and imbedding space in a convincing matter in the proposed framework. There is also the question whether space-time and imbedding space emerge uniquely from the mathematics of von Neumann algebras alone.

##### 1. The dimensions of space-time and imbedding space

Two sub-sequent inclusions dual to each other define a special kind of inclusion giving rise to a quantum counterpart of  $D = 4$  naturally. This would mean that space-time is something which emerges at the level of cognitive states.



The special role of classical division algebras in the construction of quantum TGD [K72],  $D = 8$  Bott periodicity generalized to quantum context, plus self-referential property of type  $II_1$  factors might explain why 8-dimensional imbedding space is the only possibility.

State space has naturally quantum dimension  $D \leq 8$  as the following simple argument shows. The space of quantum states has quark and lepton sectors which both are super-symmetric implying  $D \leq 4$  for each. Since these sectors correspond to different Hamiltonian algebras (triality one for quarks and triality zero for leptonic sector), the state space has quantum dimension  $D \leq 8$ .

### 2. How the lacking two space-time dimensions emerge?

3-surface is the basic dynamical unit in TGD framework. This seems to be in conflict with the effective 2-dimensionality [K72] meaning that partonic 2-surface code for quantum states, and with the fact that hyper-finite  $II_1$  factors have intrinsic quantum dimension 2.

A possible resolution of the problem is that the foliation of 3-surface by partonic two-surfaces defines a one-dimensional direct integral of isomorphic hyper-finite type  $II_1$  factors, and the zero mode labeling the 2-surfaces in the foliation serves as the third spatial coordinate. For a given 3-surface the contribution to the configuration space metric can come only from 2-D partonic surfaces defined as intersections of 3-D light-like CDs with  $X_{\pm}^7$  [?]. Hence the direct integral should somehow relate to the classical non-determinism of Kähler action.

1. The one-parameter family of intersections of light-like CD with  $X_{\pm}^7$  inside  $X^4 \cap X_{\pm}^7$  could indeed be basically due to the classical non-determinism of Kähler action. The contribution to the metric from the normal light-like direction to  $X^3 = X^4 \cap X_{\pm}^7$  can cause the vanishing of the metric determinant  $\sqrt{g_4}$  of the space-time metric at  $X^2 \subset X^3$  under some conditions on  $X^2$ . This would mean that the space-time surface  $X^4(X^3)$  is not uniquely determined by the minimization principle defining the value of the Kähler action, and the complete dynamical specification of  $X^3$  requires the specification of partonic 2-surfaces  $X_i^2$  with  $\sqrt{g_4} = 0$ .
2. The known solutions of field equations [K9] define a double foliation of the space-time surface defined by Hamilton-Jacobi coordinates consisting of complex transversal coordinate and two light-like coordinates for  $M^4$  (rather than space-time surface). Number theoretical considerations inspire the hypothesis that this foliation exists always [K72]. Hence a natural hypothesis is that the allowed partonic 2-surfaces correspond to the 2-surfaces in the restriction of the double foliation of the space-time surface by partonic 2-surfaces to  $X^3$ , and are thus locally parameterized by single parameter defining the third spatial coordinate.
3. There is however also a second light-like coordinate involved and one might ask whether both light-like coordinates appear in the direct sum decomposition of  $II_1$  factors defining  $T(CH)$ . The presence of two kinds of light-like CDs would provide the lacking two space-time coordinates and quantum dimension  $D = 4$  would emerge at the limit of full non-determinism. Note that the duality of space-like partonic and light-like stringy 2-surfaces conforms with this interpretation since it corresponds to a selection of partonic/stringy 2-surface inside given 3-D CD whereas the dual pairs correspond to different CDs.
4. That the quantum dimension would be  $2D_q = \beta < 4$  above  $CP_2$  length scale conforms with the fact that non-determinism is only partial and time direction is dynamically frozen to a high degree. For vacuum extremals there is strong non-determinism but in this case there is no real dynamics. For  $CP_2$  type extremals, which are not vacuum extremals as far action and small perturbations are considered, and which correspond to  $\beta = 4$  there is a complete non-determinism in time direction since the  $M^4$  projection of the extremal is a light-like random curve and there is full 4-D dynamics. Light-likeness gives rise to conformal symmetry consistent with the emergence of Kac Moody algebra [K9].

### 3. Time and cognition

In a completely deterministic physics time dimension is strictly speaking redundant since the information about physical states is coded by the initial values at 3-dimensional slice of space-time. Hence the notion of time should emerge at the level of cognitive representations possible by to the non-determinism of the classical dynamics of TGD.

Since Jones inclusion means the emergence of cognitive representation, the space-time view about physics should correspond to cognitive representations provided by Feynman diagram states with zero energy with entanglement defined by a two-sided projection of the lowest level S-matrix. These states would represent the "laws of quantum physics" cognitively. Also space-time surface serves as a classical correlate for the evolution by quantum jumps with maximal deterministic regions serving as correlates of quantum states. Thus the classical non-determinism making possible cognitive representations would bring in time. The fact that quantum dimension of space-time is smaller than  $D = 4$  would reflect the fact that the loss of determinism is not complete.

4. *Do space-time and imbedding space emerge from the theory of von Neumann algebras and number theory?*

The considerations above force to ask whether the notions of space-time and imbedding space emerge from von Neumann algebras as predictions rather than input. The fact that it seems possible to formulate the S-matrix and its generalization in terms of inherent properties of infinite-dimensional Clifford algebras suggest that this might be the case.

### Inner automorphisms as universal gauge symmetries?

The continuous outer automorphisms  $\Delta^{it}$  of HFFs of type III are not completely unique and one can worry about the interpretation of the inner automorphisms. A possible resolution of the worries is that inner automorphisms act as universal gauge symmetries containing various super-conformal symmetries as a special case. For hyper-finite factors of type  $II_1$  in the representation as an infinite tensor power of  $M_2(C)$  this would mean that the transformations non-trivial in a finite number of tensor factors only act as analogs of local gauge symmetries. In the representation as a group algebra of  $S_\infty$  all unitary transformations acting on a finite number of braid strands act as gauge transformations whereas the infinite powers  $P \times P \times \dots$ ,  $P \in S_n$ , would act as counterparts of global gauge transformations. In particular, the Galois group of the closure of rationals would act as local gauge transformations but diagonally represented finite Galois groups would act like global gauge transformations and periodicity would make possible to have finite braids as space-time correlates without a loss of information.

### Do unitary isomorphisms between tensor powers of $II_1$ define vertices?

What would be left would be the construction of unitary isomorphisms between the tensor products of the HFFs of type  $II_1 \otimes I_n = II_1$  at the partonic 2-surfaces defining the vertices. This would be the only new element added to the construction of braiding  $M$ -matrices.

As a matter fact, this element is actually not completely new since it generalizes the fusion rules of conformal field theories, about which standard example is the fusion rule  $\phi_i = c_i^{jk} \phi_j \phi_k$  for primary fields. These fusion rules would tell how a state of incoming HFF decomposes to the states of tensor product of two outgoing HFFs.

These rules indeed have interpretation in terms of Connes tensor products  $\mathcal{M} \otimes_{\mathcal{N}} \dots \otimes_{\mathcal{N}} \mathcal{M}$  for which the sub-factor  $\mathcal{N}$  takes the role of complex numbers [?] so that one has  $\mathcal{M}$  becomes  $\mathcal{N}$  bimodule and "quantum quantum states" have  $\mathcal{N}$  as coefficients instead of complex numbers. In TGD framework this has interpretation as quantum measurement resolution characterized by  $\mathcal{N}$  (the group  $G$  characterizing leaving the elements of  $\mathcal{N}$  invariant defines the measured quantum numbers).

### 13.5.6 Quaternions, octonions, and hyper-finite type $II_1$ factors

Quaternions and octonions as well as their hyper counterparts obtained by multiplying imaginary units by commuting  $\sqrt{-1}$  and forming a sub-space of complexified division algebra, are in in a central role in the number theoretical vision about quantum TGD [K72]. Therefore the question arises whether complexified quaternions and perhaps even octonions could be somehow inherent properties of von Neumann algebras. One can also wonder whether the quantum counterparts of quaternions and octonions could emerge naturally from von Neumann algebras. The following considerations allow to get grasp of the problem.

### Quantum quaternions and quantum octonions

Quantum quaternions have been constructed as deformation of quaternions [?]. The key observation that the Glebsch Gordan coefficients for the tensor product  $3 \otimes 3 = 5 \oplus 3 \oplus 1$  of spin 1 representation of  $SU(2)$  with itself gives the anti-commutative part of quaternionic product as spin 1 part in the decomposition whereas the commutative part giving spin 0 representation is identifiable as the scalar product of the imaginary parts. By combining spin 0 and spin 1 representations, quaternionic product can be expressed in terms of Glebsch-Gordan coefficients. By replacing GGC:s by their quantum group versions for group  $sl(2)_q$ , one obtains quantum quaternions.

There are two different proposals for the construction of quantum octonions [?, ?]. Also now the idea is to express quaternionic and octonionic multiplication in terms of Glebsch-Gordan coefficients and replace them with their quantum versions.

1. The first proposal [?] relies on the observation that for the tensor product of  $j = 3$  representations of  $SU(2)$  the Glebsch-Gordan coefficients for  $7 \otimes 7 \rightarrow 7$  in  $7 \otimes 7 = 9 \oplus 7 \oplus 5 \oplus 3 \oplus 1$  defines a product, which is equivalent with the antisymmetric part of the product of octonionic imaginary units. As a matter fact, the antisymmetry defines 7-dimensional Malcev algebra defined by the anticommutator of octonion units and satisfying b definition the identity

$$[[x, y, z], x] = [x, y, [x, z]] \quad , \quad [x, y, z] \equiv [x, [y, z]] + [y, [z, x]] + [z, [x, y]] \quad . \quad (13.5.1)$$

7-element Malcev algebra defining derivations of octonionic algebra is the only complex Malcev algebra not reducing to a Lie algebra. The  $j = 0$  part of the product corresponds also now to scalar product for imaginary units. Octonions are constructed as sums of  $j = 0$  and  $j = 3$  parts and quantum Glebsch-Gordan coefficients define the octonionic product.

2. In the second proposal [?] the quantum group associated with  $SO(8)$  is used. This representation does not allow unit but produces a quantum version of octonionic triality assigning to three octonions a real number.

### Quaternionic or octonionic quantum mechanics?

There have been numerous attempts to introduce quaternions and octonions to quantum theory. Quaternionic or octonionic quantum mechanics, which means the replacement of the complex numbers as coefficient field of Hilbert space with quaternions or octonions, is the most obvious approach (for example and references to the literature see for instance [?]).

In both cases non-commutativity poses serious interpretational problems. In the octonionic case the non-associativity causes even more serious obstacles [?, ?], [?].

1. Assuming that an orthonormalized state basis with respect to an octonion valued inner product has been found, the multiplication of any basis with octonion spoils the orthonormality. The proposal to circumvent this difficulty discussed in [?], [?] eliminates non-associativity by assuming that octonions multiply states one by one (rather than multiplying each other before multiplying the state). Effectively this means that octonions are replaced with  $8 \times 8$ -matrices.
2. The definition of the tensor product leads also to difficulties since associativity is lost (recall that Yang-Baxter equation codes for associativity in case of braid statistics [?]).
3. The notion of hermitian conjugation is problematic and forces a selection of a preferred imaginary unit, which does not look nice. Note however that the local selection of a preferred imaginary unit is in a key role in the proposed construction of space-time surfaces as hyper-quaternionic or co-hyper-quaternionic surfaces and allows to interpret space-time surfaces either as surfaces in 8-D Minkowski space  $M^8$  of hyper-octonions or in  $M^4 \times CP_2$ . This selection turns out to have quite different interpretation in the proposed framework.

### Hyper-finite factor $II_1$ has a natural Hyper-Kähler structure

In the case of hyper-finite factors of type  $II_1$  quaternions a more natural approach is based on the generalization of the Hyper-Kähler structure rather than quaternionic quantum mechanics. The reason is that also configuration space tangent space should and is expected to have this structure [?]. The Hilbert space remains a complex Hilbert space but the quaternionic units are represented as operators in Hilbert space. The selection of the preferred unit is necessary and natural. The identity operator representing quaternionic real unit has trace equal to one, is expected to give rise to the series of quantum quaternion algebras in terms of inclusions  $\mathcal{N} \subset \mathcal{M}$  having interpretation as  $N$ -modules.

The representation of the quaternion units is rather explicit in the structure of hyper-finite  $II_1$  factor. The  $\mathcal{M} : \mathcal{N} \equiv \beta = 4$  hierarchical construction can be regarded as Connes tensor product of infinite number of 4-D Clifford algebras of Euclidian plane with Euclidian signature of metric ( $diag(-1, -1)$ ). This algebra is nothing but the quaternionic algebra in the representation of quaternionic imaginary units by Pauli spin matrices multiplied by  $i$ .

The imaginary unit of the underlying complex Hilbert space must be chosen and there is whole sphere  $S^2$  of choices and in every point of configuration space the choice can be made differently. The space-time correlate for this local choice of preferred hyper-octonionic unit [K72]. At the level of configuration space geometry the quaternion structure of the tangent space means the existence of Hyper-Kähler structure guaranteing that configuration space has a vanishing Einstein tensor. It it would not vanish, curvature scalar would be infinite by symmetric space property (as in case of loop spaces) and induce a divergence in the functional integral over 3-surfaces from the expansion of  $\sqrt{g}$  [?].

The quaternionic units for the  $II_1$  factor, are simply limiting case for the direct sums of  $2 \times 2$  units normalized to one. Generalizing from  $\beta = 4$  to  $\beta < 4$ , the natural expectation is that the representation of the algebra as  $\beta = \mathcal{M} : \mathcal{N}$ -dimensional  $\mathcal{N}$ -module gives rise to quantum quaternions with quaternion units defined as infinite sums of  $\sqrt{\beta} \times \sqrt{\beta}$  matrices.

At Hilbert space level one has an infinite Connes tensor product of 2-component spinor spaces on which quaternionic matrices have a natural action. The tensor product of Clifford algebras gives the algebra of  $2 \times 2$  quaternionic matrices acting on 2-component quaternionic spinors (complex 4-component spinors). Thus double inclusion could correspond to (hyper-)quaternionic structure at space-time level. Note however that the correspondence is not complete since hyper-quaternions appear at space-time level and quaternions at Hilbert space level.

### Von Neumann algebras and octonions

The octonionic generalization of the Hyper-Kähler manifold does not make sense as such since octonionic units are not representable as linear operators. The allowance of anti-linear operators inherently present in von Neumann algebras could however save the situation. Indeed, the Cayley-Dickson construction for the division algebras (for a nice explanation see [?]), which allows to extend any  $*$  algebra, and thus also any von Neumann algebra, by adding an imaginary unit it and identified as  $*$ , comes in rescue.

The basic idea of the Cayley-Dickson construction is following. The  $*$  operator, call it  $J$ , representing a conjugation defines an *anti-linear* operator in the original algebra  $A$ . One can extend  $A$  by adding this operator as a new element to the algebra. The conditions satisfied by  $J$  are

$$a(Jb) = J(a*b) \ , \ (aJ)b = (ab*)J \ , \ (Ja)(bJ^{-1}) = (ab)^* \ . \quad (13.5.2)$$

In the associative case the conditions are equivalent to the first condition.

It is intuitively clear that this addition extends the hyper-Kähler structure to an octonionic structure at the level of the operator algebra. The quantum version of the octonionic algebra is fixed by the quantum quaternion algebra uniquely and is consistent with the Cayley-Dickson construction. It is not clear whether the construction is equivalent with either of the earlier proposals [?, ?]. It would however seem that the proposal is simpler.

### Physical interpretation of quantum octonion structure

Without further restrictions the extension by  $J$  would mean that vertices contain operators, which are superpositions of linear and anti-linear operators. This would give superpositions of states and

their time-reversals and mean that state could be a superposition of states with opposite values of say fermion numbers. The problem disappears if either the linear operators  $A$  or anti-linear operators  $JA$  can be used to construct physical states from vacuum. The fact, that space-time surfaces are either hyper-quaternionic or co-hyper-quaternionic, is a space-time correlate for this restriction.

The  $HQ-coHQ$  duality discussed in [K72] states that the descriptions based on hyper-quaternionic and co-hyper-quaternionic surfaces are dual to each other. The duality can have two meanings.

1. The vacuum is invariant under  $J$  so that one can use either complexified quaternionic operators  $A$  or their co-counterparts of form  $JA$  to create physical states from vacuum.
2. The vacuum is not invariant under  $J$ . This could relate to the breaking of  $CP$  and  $T$  invariance known to occur in meson-antimeson systems. In TGD framework two kinds of vacua are predicted corresponding intuitively to vacua in which either the product of all positive or negative energy fermionic oscillator operators defines the vacuum state, and these two vacua could correspond to a vacuum and its  $J$  conjugate, and thus to positive and negative energy states. In this case the two state spaces would not be equivalent although the physics associated with them would be equivalent.

The considerations of [K72] related to the detailed dynamics of  $HQ-coHQ$  duality demonstrate that the variational principles defining the dynamics of hyper-quaternionic and co-hyper-quaternionic space-time surfaces are antagonistic and correspond to world as seen by a conscientious book-keeper on one hand and an imaginative artist on the other hand.  $HQ$  case is conservative: differences measured by the magnitude of Kähler action tend to be minimized, the dynamics is highly predictive, and minimizes the classical energy of the initial state.  $coHQ$  case is radical: differences are maximized (this is what the construction of sensory representations would require). The interpretation proposed in [K72] was that the two space-time dynamics are just different predictions for what would happen (has happened) if no quantum jumps would occur (had occurred). A stronger assumption is that these two views are associated with systems related by time reversal symmetry.

What comes in mind first is that this antagonism follows from the assumption that these dynamics are actually time-reversals of each other with respect to  $M^4$  time (the rapid elimination of differences in the first dynamics would correspond to their rapid enhancement in the second dynamics). This is not the case so that  $T$  and  $CP$  symmetries are predicted to be broken in accordance with the  $CP$  breaking in meson-antimeson systems [K43] and cosmological matter-antimatter asymmetry [K66].

### 13.5.7 Does the hierarchy of infinite primes relate to the hierarchy of $II_1$ factors?

The hierarchy of Feynman diagrams accompanying the hierarchy defined by Jones inclusions  $\mathcal{M}_0 \subset \mathcal{M}_1 \subset \dots$  gives a concrete representation for the hierarchy of cognitive dynamics providing a representation for the material world at the lowest level of the hierarchy. This hierarchy seems to relate directly to the hierarchy of space-time sheets.

Also the construction of infinite primes [?] leads to an infinite hierarchy. Infinite primes at the lowest level correspond to polynomials of single variable  $x_1$  with rational coefficients, next level to polynomials  $x_1$  for which coefficients are rational functions of variable  $x_2$ , etc... so that a natural ordering of the variables is involved.

If the variables  $x_i$  are hyper-octonions (sub-space of complexified octonions for which elements are of form  $x + \sqrt{-1}y$ , where  $x$  is real number and  $y$  imaginary octonion and  $\sqrt{-1}$  is commuting imaginary unit, this hierarchy of states could provide a realistic representation of physical states as far as quantum numbers related to imbedding space degrees of freedom are considered in  $M^8$  picture dual to  $M^4 \times CP_2$  picture [K72]. Infinite primes are mapped to space-time surfaces in a manner analogous to the mapping of polynomials to the loci of their zeros so that infinite primes, integers, and rationals become concrete geometrical objects.

Infinite primes are also obtained by a repeated second quantization of a super-symmetric arithmetic quantum field theory. Infinite rational numbers correspond in this description to pairs of positive energy and negative energy states of opposite energies having interpretation as pairs of initial and final states so that higher level states indeed represent transitions between the states. For these reasons this hierarchy has been interpreted as a correlate for a cognitive hierarchy coding information about quantum dynamics at lower levels. This hierarchy has also been assigned with the hierarchy of

space-time sheets. Just as the hierarchy of generalized Feynman diagrams provides self representations of the lowest matter level and is coded by it, finite primes code the hierarchy of infinite primes.

Infinite primes, integers, and rationals have finite p-adic norms equal to 1, and one can wonder whether a Hilbert space like structure with dimension given by an infinite prime or integer makes sense, and whether it has anything to do with the Hilbert space for which dimension is infinite in the sense of the limiting value for a dimension of sub-space. The Hilbert spaces with dimension equal to infinite prime would define primes for the tensor product of these spaces. The dimension of this kind of space defined as any p-adic norm would be equal to one.

One cannot exclude the possibility that infinite primes could express the infinite dimensions of hyper-finite  $III_1$  factors, which cannot be excluded and correspond to that part of quantum TGD which relates to the imbedding space rather than space-time surface. Indeed, infinite primes code naturally for the quantum numbers associated with the imbedding space. Secondly, the appearance of 7-D light-like causal determinants  $X_{\pm}^7 = M_{\pm}^4 \times CP_2$  forming nested structures in the construction of S-matrix brings in mind similar nested structures of algebraic quantum field theory [?]. If this is were the case, the hierarchy of Beraha numbers possibly associated with the phase resolution could correspond to hyper-finite factors of type  $II_1$ , and the decomposition of space-time surface to regions labeled by p-adic primes and characterized by infinite primes could correspond to hyper-finite factors of type  $III_1$  and represent imbedding space degrees of freedom.

The state space would in this picture correspond to the tensor products of hyper-finite factors of type  $II_1$  and  $III_1$  (of course, also factors  $I_n$  and  $I_{\infty}$  are also possible).  $III_1$  factors could be assigned to the sub-configuration spaces defined by 3-surfaces in regions of  $M^4$  expressible in terms of unions and intersections of  $X_{\pm}^7 = M_{\pm}^4 \times CP_2$ . By conservation of four-momentum, bounded regions of this kind are possible only for the states of zero net energy appearing at the higher levels of hierarchy. These sub-configuration spaces would be characterized by the positions of the tips of light cones  $M_{\pm}^4 \subset M^4$  involved. This indeed brings in continuous spectrum of four-momenta forcing to introduce non-separable Hilbert spaces for momentum eigen states and necessitating  $III_1$  factors. Infinities would be avoided since the dynamics proper would occur at the level of space-time surfaces and involve only  $II_1$  factors.

## 13.6 Could HFFs of type $III$ have application in TGD framework?

One can imagine several manners for how HFFs of type  $III$  could emerge in TGD although the proposed view about  $M$ -matrix in zero energy ontology suggests that HFFs of type  $III_1$  should be only an auxiliary tool at best. Same is suggested with interpretational problems associated with them. Both TGD inspired quantum measurement theory, the idea about a variant of HFF of type  $II_1$  analogous to a local gauge algebra, and some other arguments, suggest that HFFs of type  $III$  could be seen as a useful idealization allowing to make non-trivial conjectures both about quantum TGD and about HFFs of type  $III$ . Quantum fields would correspond to HFFs of type  $III$  and  $II_{\infty}$  whereas physical states ( $M$ -matrix) would correspond to HFF of type  $II_1$ . I have summarized first the problems of  $III_1$  factors so that reader can decide whether the further reading is worth of it.

### 13.6.1 Problems associated with the physical interpretation of $III_1$ factors

Algebraic quantum field theory approach [?, ?] has led to a considerable understanding of relativistic quantum field theories in terms of hyper-finite  $III_1$  factors. There are however several reasons to suspect that the resulting picture is in conflict with physical intuition. Also the infinities of non-trivial relativistic QFTs suggest that something goes wrong.

#### Are the infinities of quantum field theories due the wrong type of von Neumann algebra?

The infinities of quantum field theories involve basically infinite traces and it is now known that the algebras of observables for relativistic quantum field theories for bounded regions of Minkowski space correspond to hyper-finite  $III_1$  algebras, for which non-trivial traces are always infinite. This might be the basic cause of the divergence problems of relativistic quantum field theory.

On basis of this observations there is some temptation to think that the finite traces of hyper-finite  $III_1$  algebras might provide a resolution to the problems but not necessarily in QFT context. One can play with the thought that the subtraction of infinities might be actually a process in which  $III_1$  algebra is transformed to  $II_1$  algebra. A more plausible idea suggested by dimensional regularization is that the elimination of infinities actually gives rise to  $II_1$  inclusion at the limit  $\mathcal{M} : \mathcal{N} \rightarrow 4$ . It is indeed known that the dimensional regularization procedure of quantum field theories can be formulated in terms of bi-algebras assignable to Feynman diagrams and [?] and the emergence of bi-algebras suggests that a connection with  $II_1$  factors and critical role of dimension  $D = 4$  might exist.

### Continuum of inequivalent representations of commutation relations

There is also a second difficulty related to type III algebras. There is a continuum of inequivalent representations for canonical commutation relations [?]. In thermodynamics this is blessing since temperature parameterizes these representations. In quantum field theory context situation is however different and this problem has been usually put under the rug.

### Entanglement and von Neumann algebras

In quantum field theories where 4-D regions of space-time are assigned to observables. In this case hyper-finite type  $III_1$  von Neumann factors appear. Also now inclusions make sense and has been studied in fact, the parameters characterizing Jones inclusions appear also now and this due to the very general properties of the inclusions.

The algebras of type  $III_1$  have rather counter-intuitive properties from the point of view of entanglement. For instance, product states between systems having space-like separation are not possible at all so that one can speak of intrinsic entanglement [?]. What looks worse is that the decomposition of entangled state to product states is highly non-unique.

Mimicking the steps of von Neumann one could ask what the notion of observables could mean in TGD framework. Effective 2-dimensionality states that quantum states can be constructed using the data given at partonic or stringy 2-surfaces. This data includes also information about normal derivatives so that 3-dimensionality actually lurks in. In any case this would mean that observables are assignable to 2-D surfaces. This would suggest that hyper-finite  $II_1$  factors appear in quantum TGD at least as the contribution of single space-time surface to S-matrix is considered. The contributions for configuration space degrees of freedom meaning functional (not path-) integral over 3-surfaces could of course change the situation.

Also in case of  $II_1$  factors, entanglement shows completely new features which need not however be in conflict with TGD inspired view about entanglement. The eigen values of density matrices are infinitely degenerate and quantum measurement can remove this degeneracy only partially. TGD inspired theory of consciousness has led to the identification of rational (more generally algebraic entanglement) as bound state entanglement stable in state function reduction. When an infinite number of states are entangled, the entanglement would correspond to rational (algebraic number) valued traces for the projections to the eigen states of the density matrix. The symplectic transformations of  $CP_2$  are almost  $U(1)$  gauge symmetries broken only by classical gravitation. They imply a gigantic spin glass degeneracy which could be behind the infinite degeneracies of eigen states of density matrices in case of  $II_1$  factors.

## 13.6.2 Quantum measurement theory and HFFs of type III

The attempt to interpret the HFFs of type III in terms of quantum measurement theory based on Jones inclusions leads to highly non-trivial conjectures about these factors.

### Could the scalings of trace relate to quantum measurements?

What should be understood is the physical meaning of the automorphism inducing the scaling of trace. In the representation based of factors based on infinite tensor powers the action of  $g$  should transform single  $n \times n$  matrix factor with density matrix  $Id/n$  to a density matrix  $e_{11}$  of a pure state.

Obviously the number of degrees of freedom is affected and this can be interpreted in terms of appearance or disappearance of correlations. Quantization and emergence of non-commutativity indeed

implies the emergence of correlations and effective reduction of degrees of freedom. In particular, the fundamental quantum Clifford algebra has reduced dimension  $\mathcal{M} : \mathcal{N} = r \leq 4$  instead of  $r = 4$  since the replacement of complex valued matrix elements with  $\mathcal{N}$  valued ones implies non-commutativity and correlations.

The transformation would be induced by the shift of finite-dimensional state to right or left so that the number of matrix factors overlapping with  $I_\infty$  part increases or is reduced. Could it have interpretation in terms of quantum measurement for a quantum Clifford factor? Could quantum measurement for  $\mathcal{M}/\mathcal{N}$  degrees of freedom reducing the state in these degrees of freedom to a pure state be interpreted as a transformation of single finite-dimensional matrix factor to a type I factor inducing the scaling of the trace and could the scalings associated with automorphisms of HFFs of type III also be interpreted in terms of quantum measurement?

This interpretation does not as such say anything about HFF factors of type III since only a decomposition of  $II_1$  factor to  $I_2^k$  factor and  $II_1$  factor with a reduced trace of projector to the latter. However, one can ask whether the scaling of trace for HFFs of type III could correspond to a situation in which infinite number of finite-dimensional factors have been quantum measured. This would correspond to the inclusion  $\mathcal{N} \subset \mathcal{M}_\infty = \cup_n \mathcal{M}_n$  where  $\mathcal{N} \subset \mathcal{M} \subset \dots \mathcal{M}_n \dots$  defines the canonical inclusion sequence. Physicist can of course ask whether the presence of infinite number of  $I_2$ -, or more generally,  $I_n$ -factors is at all relevant to quantum measurement and it has already become clear that situation at the level of  $M$ -matrix reduces to  $I_n$ .

**Could the theory of HFFs of type III relate to the theory of Jones inclusions?**

The idea about a connection of HFFs of type III and quantum measurement theory seems to be consistent with the basic facts about inclusions and HFFs of type  $III_1$ .

1. Quantum measurement would scale the trace by a factor  $2^k/\sqrt{\mathcal{M} : \mathcal{N}}$  since the trace would become a product for the trace of the projector to the newly born  $M(2, C)^{\otimes k}$  factor and the trace for the projection to  $\mathcal{N}$  given by  $1/\sqrt{\mathcal{M} : \mathcal{N}}$ . The continuous range of values  $\mathcal{M} : \mathcal{N} \geq 4$  gives good hopes that all values of  $\lambda$  are realized. The prediction would be that  $2^k \sqrt{\mathcal{M} : \mathcal{N}} \geq 1$  holds always true.
2. The values  $\mathcal{M} : \mathcal{N} \in \{r_n = 4\cos^2(\pi/n)\}$  for which the single  $M(2, C)$  factor emerges in state function reduction would define preferred values of the inverse of  $\lambda = \sqrt{\mathcal{M} : \mathcal{N}}/4$  parameterizing factors  $III_\lambda$ . These preferred values vary in the range  $[1/2, 1]$ .
3.  $\lambda = 1$  at the end of continuum would correspond to HFF  $III_1$  and to Jones inclusions defined by infinite cyclic subgroups dense in  $U(1) \subset SU(2)$  and this group combined with reflection. These groups correspond to the Dynkin diagrams  $A_\infty$  and  $D_\infty$ . Also the classical values of  $\mathcal{M} : \mathcal{N} = n^2$  characterizing the dimension of the quantum Clifford  $\mathcal{M} : \mathcal{N}$  are possible. In this case the scaling of trace would be trivial since the factor  $n$  to the trace would be compensated by the factor  $1/n$  due to the disappearance of  $\mathcal{M}/\mathcal{N}$  factor  $III_1$  factor.
4. Inclusions with  $\mathcal{M} : \mathcal{N} = \infty$  are also possible and they would correspond to  $\lambda = 0$  so that also  $III_0$  factor would also have a natural identification in this framework. These factors correspond to ergodic systems and one might perhaps argue that quantum measurement in this case would give infinite amount of information.
5. This picture makes sense also physically. p-Adic thermodynamics for the representations of super-conformal algebra could be formulated in terms of factors of type  $I_\infty$  and in excellent approximation using factors  $I_n$ . The generation of arbitrary number of type  $II_1$  factors in quantum measurement allow this possibility.

**The end points of spectrum of preferred values of  $\lambda$  are physically special**

The fact that the end points of the spectrum of preferred values of  $\lambda$  are physically special, supports the hopes that this picture might have something to do with reality.

1. The Jones inclusion with  $q = \exp(i\pi/n)$ ,  $n = 3$  (with principal diagram reducing to a Dynkin diagram of group  $SU(3)$ ) corresponds to  $\lambda = 1/2$ , which corresponds to HFF  $III_1$  differing in



essential manner from factors  $III_\lambda$ ,  $\lambda < 1$ . On the other hand,  $SU(3)$  corresponds to color group which appears as an isometry group and important subgroup of automorphisms of octonions thus differs physically from the ADE gauge groups predicted to be realized dynamically by the TGD based view about McKay correspondence [?].

2. For  $r = 4$   $SU(2)$  inclusion parameterized by extended ADE diagrams  $M(2, C)^{\otimes 2}$  would be created in the state function reduction and also this would give  $\lambda = 1/2$  and scaling by a factor of 2. Hence the end points of the range of discrete spectrum would correspond to the same scaling factor and same HFF of type III.  $SU(2)$  could be interpreted either as electro-weak gauge group, group of rotations of the geodesic sphere of  $\delta M_\pm^4$ , or a subgroup of  $SU(3)$ . In TGD interpretation for McKay correspondence a phase transition replacing gauge symmetry with Kac-Moody symmetry.
3. The scalings of trace by factor 2 seem to be preferred physically which should be contrasted with the fact that primes near prime powers of 2 and with the fact that quantum phases  $q = \exp(i\pi/n)$  with  $n$  equal to Fermat integer proportional to power of 2 and product of the Fermat primes (the known ones are 5, 17, 257, and  $2^{16} + 1$ ) are in a special role in TGD Universe.

### 13.6.3 What could one say about $II_1$ automorphism associated with the $II_\infty$ automorphism defining factor of type III?

An interesting question relates to the interpretation of the automorphisms of  $II_\infty$  factor inducing the scaling of trace.

1. If the automorphism for Jones inclusion involves the generator of cyclic automorphism sub-group  $Z_n$  of  $II_1$  factor then it would seem that for other values of  $\lambda$  this group cannot be cyclic.  $SU(2)$  has discrete subgroups generated by arbitrary phase  $q$  and these are dense in  $U(1) \subset SU(2)$  sub-group. If the interpretation in terms of Jones inclusion makes sense then the identification  $\lambda = \sqrt{\mathcal{M} : \mathcal{N}}/2^k$  makes sense.
2. If HFF of type  $II_1$  is realized as group algebra of infinite symmetric group [?], the outer automorphism induced by the diagonally imbedded finite Galois groups can induce only integer values of  $n$  and  $Z_n$  would correspond to cyclic subgroups. This interpretation conforms with the fact that the automorphisms in the completion of inner automorphisms of HFF of type  $II_1$  induce trivial scalings. Therefore only automorphisms which do not belong to this completion can define HFFs of type III.

### 13.6.4 What could be the physical interpretation of two kinds of invariants associated with HFFs type III?

TGD predicts two kinds of counterparts for  $S$ -matrix:  $M$ -matrix and  $U$ -matrix. Both are expected to be more or less universal.

There are also *two* kinds of invariants and automorphisms associated with HFFs of type III.

1. The first invariant corresponds to the scaling  $\lambda \in ]0, 1[$  of the trace associated with the automorphism of factor of  $II_\infty$ . Also the end points of the interval make sense. The inverse of this scaling accompanies the inverse of this automorphism.
2. Second invariant corresponds to the time scales  $t = T_0$  for which the outer automorphism  $\sigma_t$  reduces to inner automorphism. It turns out that  $T_0$  and  $\lambda$  are related by the formula  $\lambda^{iT_0} = 1$ , which gives the allowed values of  $T_0$  as  $T_0 = n2\pi/\log(\lambda)$  [?]. This formula can be understood intuitively by realizing that  $\lambda$  corresponds to the eigenvalue of the density matrix  $\Delta = e^H$  in the simplest possible realization of the state  $\phi$ .

The presence of two automorphisms and invariants brings in mind  $U$  matrix characterizing the unitary process occurring in quantum jump and  $M$ -matrix characterizing time like entanglement.

1. If one accepts the vision based on quantum measurement theory then  $\lambda$  corresponds to the scaling of the trace resulting when quantum Clifford algebra  $\mathcal{M}/\mathcal{N}$  reduces to a tensor power of  $M(2, C)$  factor in the state function reduction. The proposed interpretation for  $U$  process would be as the inverse of state function reduction transforming this factor back to  $\mathcal{M}/\mathcal{N}$ . Thus  $U$  process and state function reduction would correspond naturally to the scaling and its inverse. This picture might apply not only in single particle case but also for zero energy states which can be seen as states associated the a tensor power of HFFs of type  $II_1$  associated with partons.
2. The implication is that  $U$  process can occur only in the direction in which trace is reduced. This would suggest that the full  $III_1$  factor is not a physical notion and that one must restrict the group  $Z$  in the crossed product  $Z \times_{cr} II_\infty$  to the group  $N$  of non-negative integers. In this kind of situation the trace is well defined since the traces for the terms in the crossed product comes as powers  $\lambda^{-n}$  so that the net result is finite. This would mean a reduction to  $II_\infty$  factor.
3. Since time  $t$  is a natural parameter in elementary particle physics experiment, one could argue that  $\sigma_t$  could define naturally  $M$ -matrix. Time parameter would most naturally correspond to a parameter of scaling affecting all  $M_\pm^4$  coordinates rather than linear time. This conforms also with the fundamental role of conformal transformations and scalings in TGD framework.

The identification of the full  $M$ -matrix in terms of  $\sigma$  does not seem to make sense generally. It would however make sense for incoming and outgoing number theoretic braids so that  $\sigma$  could define universal braiding  $M$ -matrices. Inner automorphisms would bring in the dependence on experimental situation. The reduction of the braiding matrix to an inner automorphism for critical values of  $t$  which could be interpreted in terms of scaling by power of  $p$ . This trivialization would be a counterpart for the elimination of propagator legs from  $M$ -matrix element. Vertex itself could be interpreted as unitary isomorphism between tensor product of incoming and outgoing HFFs of type  $II_1$  would code all what is relevant about the particle reaction.

### 13.6.5 Does the time parameter $t$ represent time translation or scaling?

The connection  $T_n = n2\pi/\log(\lambda)$  would give a relationship between the scaling of trace and value of time parameter for which the outer automorphism represented by  $\sigma$  reduces to inner automorphism. It must be emphasized that the time parameter  $t$  appearing in  $\sigma$  need not have anything to do with time translation. The alternative interpretation is in terms of  $M_\pm^4$  scaling (implying also time scaling) but one cannot exclude even preferred Lorentz boosts in the direction of quantization axis of angular momentum.

#### Could the time parameter correspond to scaling?

The central role of conformal invariance in quantum TGD suggests that  $t$  parameterizes scaling rather than translation. In this case scalings would correspond to powers of  $(K\lambda)^n$ . The numerical factor  $K$  which cannot be excluded a priori, seems to reduce to  $K = 1$ .

1. The scalings by powers of  $p$  have a simple realization in terms of the representation of HFF of type  $II_\infty$  as infinite tensor power of  $M(p, C)$  with suitably chosen densities matrices in factors to get product of  $I_\infty$  and  $II_1$  factor. These matrix algebras have the remarkable property of defining prime tensor power factors of finite matrix algebras. Thus p-adic fractality would reflect directly basic properties of matrix algebras as suggested already earlier. That scalings by powers of  $p$  would correspond to automorphism reducing to inner automorphisms would conform with p-adic fractality.
2. Also scalings by powers  $[\sqrt{\mathcal{M} : \mathcal{N}/2^k}]^n$  would be physically preferred if one takes previous arguments about Jones inclusions seriously and if also in this case scalings are involved. For  $q = \exp(i\pi/n)$ ,  $n = 5$  the minimal value of  $n$  allowing universal topological quantum computation would correspond to a scaling by Golden Mean and these fractal scalings indeed play a key role in living matter. In particular, Golden Mean makes it visible in the geometry of DNA.

### Could the time parameter correspond to time translation?

One can consider also the interpretation of  $\sigma_t$  as time translation. TGD predicts a hierarchy of Planck constants parameterized by rational numbers such that integer multiples are favored. In particular, integers defining ruler and compass polygons are predicted to be in a very special role physically. Since the geometric time span associated with zero energy state should scale as Planck constant one expects that preferred values of time  $t$  associated with  $\sigma$  are quantized as rational multiples of some fundamental time scales, say the basic time scale defined by  $CP_2$  length or p-adic time scales.

1. For  $\lambda = 1/p$ ,  $p$  prime, the time scale would be  $T_n = nT_1$ ,  $T_1 = T_0 = 2\pi/\log(p)$  which is not what p-adic length scale hypothesis would suggest.
2. For Jones inclusions one would have  $T_n/T_0 = n2\pi/\log(2^{2k}/\mathcal{M} : \mathcal{N})$ . In the limit when  $\lambda$  becomes very small (the number  $k$  of reduced  $M(2, C)$  factors is large one obtains  $T_n = (n/k)t_1$ ,  $T_1 = T_0\pi/\log(2)$ . Approximate rational multiples of the basic length scale would be obtained as also predicted by the general quantization of Planck constant.

### p-Adic thermodynamics from first principles

Quantum field theory at non-zero temperature can be formulated in the functional integral formalism by replacing the time parameter associated with the unitary time evolution operator  $U(t)$  with a complexified time containing as imaginary part the inverse of the temperature:  $t \rightarrow t + i\hbar/T$ . In the framework of standard quantum field theory this is a mere computational trick but the time parameter associated with the automorphisms  $\sigma_t$  of HFF of type III is a temperature like parameter from the beginning, and its complexification would naturally lead to the analog of thermal QFT.

Thus thermal equilibrium state would be a genuine quantum state rather than fictive but useful auxiliary notion. Thermal equilibrium is defined separately for each incoming parton braid and perhaps even braid (partons can have arbitrarily large size). At elementary particle level p-adic thermodynamics could be in question so that particle massivation would have first principle description. p-Adic thermodynamics is under relatively mild conditions equivalent with its real counterpart obtained by the replacement of  $p^{L_0}$  interpreted as a p-adic number with  $p^{-L_0}$  interpreted as a real number.

### 13.6.6 Could HFFs of type III be associated with the dynamics in $M_{\pm}^4$ degrees of freedom?

HFFs of type III could be also assigned with the poorly understood dynamics in  $M_{\pm}^4$  degrees of freedom which should have a lot of to do with four-dimensional quantum field theory. Hyper-finite factors of type III<sub>1</sub> might emerge when one extends II<sub>1</sub> to a local algebra by multiplying it with hyper-octonions replaced as analog of matrix factor and considers hyper-quaternionic subalgebra. The resulting algebra would be the analog of local gauge algebra and the elements of algebra would be analogous to conformal fields with complex argument replaced with hyper-octonionic, -quaternionic, or -complex one. Since quantum field theory in  $M^4$  gives rise to hyper-finite III<sub>1</sub> factors one might guess that the hyper-quaternionic restriction indeed gives these factors.

The expansion of the local HFF II<sub>∞</sub> element as  $O(m) = \sum_n m^n O_n$ , where  $M^4$  coordinate  $m$  is interpreted as hyper-quaternion, could have interpretation as expansion in which  $O_n$  belongs to  $\mathcal{N}g^n$  in the crossed product  $\mathcal{N} \times_{cr} \{g^n, n \in \mathbb{Z}\}$ . The analogy with conformal fields suggests that the power  $g^n$  inducing  $\lambda^n$  fold scaling of trace increases the conformal weight by  $n$ .

One can ask whether the scaling of trace by powers of  $\lambda$  defines an inclusion hierarchy of sub-algebras of conformal sub-algebras as suggested by previous arguments. One such hierarchy would be the hierarchy of sub-algebras containing only the generators  $O_m$  with conformal weight  $m \geq n$ ,  $n \in \mathbb{Z}$ .

It has been suggested that the automorphism  $\Delta$  could correspond to scaling inside light-cone. This interpretation would fit nicely with Lorentz invariance and TGD in general. The factors III<sub>λ</sub> with  $\lambda$  generating semi-subgroups of integers (in particular powers of primes) could be of special physical importance in TGD framework. The values of  $t$  for which automorphism reduces to inner automorphism should be of special physical importance in TGD framework. These automorphisms correspond to scalings identifiable in terms of powers of p-adic prime  $p$  so that p-adic fractality would find an explanation at the fundamental level.

If the above mentioned expansion in powers of  $m^n$  of  $M_{\pm}^4$  coordinate makes sense then the action of  $\sigma^t$  representing a scaling by  $p^n$  would leave the elements  $O$  invariant or induce a mere inner automorphism. Conformal weight  $n$  corresponds naturally to  $n$ -ary  $p$ -adic length scale by uncertainty principle in  $p$ -adic mass calculations.

The basic question is the physical interpretation of the automorphism inducing the scaling of trace by  $\lambda$  and its detailed action in HFF. This scaling could relate to a scaling in  $M^4$  and to the appearance in the trace of an integral over  $M^4$  or subspace of it defining the trace. Fractal structures suggests itself strongly here. At the level of construction of physical states one always selects some minimum non-positive conformal weight defining the tachyonic ground state and physical states have non-negative conformal weights. The interpretation would be as a reduction to HFF of type  $II_{\infty}$  or even  $II_1$ .

### 13.6.7 Could the continuation of braidings to homotopies involve $\Delta^{it}$ automorphisms

The representation of braidings as special case of homotopies might lead from discrete automorphisms for HFFs type  $II_1$  to continuous outer automorphisms for HFFs of type  $III_1$ . The question is whether the periodic automorphism of  $II_1$  represented as a discrete sub-group of  $U(1)$  would be continued to  $U(1)$  in the transition.

The automorphism of  $II_{\infty}$  HFF associated with a given value of the scaling factor  $\lambda$  is unique. If Jones inclusions defined by the preferred values of  $\lambda$  as  $\lambda = \sqrt{\mathcal{M} : \mathcal{N} / 2^k}$  (see the previous considerations), then this automorphism could involve a periodic automorphism of  $II_1$  factor defined by the generator of cyclic subgroup  $Z_n$  for  $\mathcal{M} : \mathcal{N} < 4$  besides additional shift transforming  $II_1$  factor to  $I_{\infty}$  factor and inducing the scaling.

### 13.6.8 HFFs of type $III$ as super-structures providing additional uniqueness?

If the braiding  $M$ -matrices are as such highly unique. One could however consider the possibility that they are induced from the automorphisms  $\sigma_t$  for the HFFs of type  $III$  restricted to HFFs of type  $II_{\infty}$ . If a reduction to inner automorphism in HFF of type  $III$  implies same with respect to HFF of type  $II_{\infty}$  and even  $II_1$ , they could be trivial for special values of time scaling  $t$  assignable to the partons and identifiable as a power of prime  $p$  characterizing the parton. This would allow to eliminate incoming and outgoing legs. This elimination would be the counterpart of the division of propagator legs in quantum field theories. Particle masses would however play no role in this process now although the power of  $p$ -adic prime would fix the mass scale of the particle.

## 13.7 The almost latest vision about the role of HFFs in TGD

It is clear that at least the hyper-finite factors of type  $II_1$  assignable to WCW spinors must have a profound role in TGD. Whether also HFFs of type  $III_1$  appearing also in relativistic quantum field theories emerge when WCW spinors are replaced with spinor fields is not completely clear. I have proposed several ideas about the role of hyper-finite factors in TGD framework. In particular, Connes tensor product is an excellent candidate for defining the notion of measurement resolution.

In the following this topic is discussed from the perspective made possible by zero energy ontology and the recent advances in the understanding of  $M$ -matrix using the notion of bosonic emergence. The conclusion is that the notion of state as it appears in the theory of factors is not enough for the purposes of quantum TGD. The reason is that state in this sense is essentially the counterpart of thermodynamical state. The construction of  $M$ -matrix might be understood in the framework of factors if one replaces state with its "complex square root" natural if quantum theory is regarded as a "complex square root" of thermodynamics. It is also found that the idea that Connes tensor product could fix  $M$ -matrix is too optimistic but an elegant formulation in terms of partial trace for the notion of  $M$ -matrix modulo measurement resolution exists and Connes tensor product allows interpretation as entanglement between sub-spaces consisting of states not distinguishable in the measurement resolution used. The partial trace also gives rise to non-pure states naturally.

### 13.7.1 Basic facts about factors

In this section basic facts about factors are discussed. My hope that the discussion is more mature than or at least complementary to the summary that I could afford when I started the work with factors for more than half decade ago. I of course admit that this just a humble attempt of a physicist to express physical vision in terms of only superficially understood mathematical notions.

#### Basic notions

First some standard notations. Let  $\mathcal{B}(\mathcal{H})$  denote the algebra of linear operators of Hilbert space  $\mathcal{H}$  bounded in the norm topology with norm defined by the supremum of for the length of the image of a point of unit sphere  $\mathcal{H}$ . This algebra has a lot of common with complex numbers in that the counterparts of complex conjugation, order structure and metric structure determined by the algebraic structure exist. This means the existence involution -that is \*- algebra property. The order structure determined by algebraic structure means following:  $A \geq 0$  defined as the condition  $(A\xi, \xi) \geq 0$  is equivalent with  $A = B^*B$ . The algebra has also metric structure  $\|AB\| \leq \|A\|\|B\|$  (Banach algebra property) determined by the algebraic structure. The algebra is also  $C^*$  algebra:  $\|A^*A\| = \|A\|^2$  meaning that the norm is algebraically like that for complex numbers.

A von Neumann algebra  $\mathcal{M}$  [?] is defined as a weakly closed non-degenerate \*-subalgebra of  $\mathcal{B}(\mathcal{H})$  and has therefore all the above mentioned properties. From the point of view of physicist it is important that a sub-algebra is in question.

In order to define factors one must introduce additional structure.

1. Let  $\mathcal{M}$  be subalgebra of  $\mathcal{B}(\mathcal{H})$  and denote by  $\mathcal{M}'$  its commutant defined as the sub-algebra of  $\mathcal{B}(\mathcal{H})$  commuting with it and allowing to express  $\mathcal{B}(\mathcal{H})$  as  $\mathcal{B}(\mathcal{H}) = \mathcal{M} \vee \mathcal{M}'$ .
2. A factor is defined as a von Neumann algebra satisfying  $\mathcal{M}'' = \mathcal{M}$   $\mathcal{M}$  is called factor. The equality of double commutant with the original algebra is thus the defining condition so that also the commutant is a factor. An equivalent definition for factor is as the condition that the intersection of the algebra and its commutant reduces to a complex line spanned by a unit operator. The condition that the only operator commuting with all operators of the factor is unit operator corresponds to irreducibility in representation theory.
3. Some further basic definitions are needed.  $\Omega \in \mathcal{H}$  is cyclic if the closure of  $\mathcal{M}\Omega$  is  $\mathcal{H}$  and separating if the only element of  $\mathcal{M}$  annihilating  $\Omega$  is zero.  $\Omega$  is cyclic for  $\mathcal{M}$  if and only if it is separating for its commutant. In so called standard representation  $\Omega$  is both cyclic and separating.
4. For hyperfinite factors an inclusion hierarchy of finite-dimensional algebras whose union is dense in the factor exists. This roughly means that one can approximate the algebra in arbitrary accuracy with a finite-dimensional sub-algebra.

The definition of the factor might look somewhat artificial unless one is aware of the underlying physical motivations. The motivating question is what the decomposition of a physical system to non-interacting sub-systems could mean. The decomposition of  $\mathcal{B}(\mathcal{H})$  to  $\vee$  product realizes this decomposition.

1. Tensor product  $\mathcal{H} = \mathcal{H}_1 \otimes \mathcal{H}_2$  is the decomposition according to the standard quantum measurement theory and means the decomposition of operators in  $\mathcal{B}(\mathcal{H})$  to tensor products of mutually commuting operators in  $\mathcal{M} = \mathcal{B}(\mathcal{H}_1)$  and  $\mathcal{M}' = \mathcal{B}(\mathcal{H}_2)$ . The information about  $\mathcal{M}$  can be coded in terms of projection operators. In this case projection operators projecting to a complex ray of Hilbert space exist and arbitrary compact operator can be expressed as a sum of these projectors. For factors of type I minimal projectors exist. Factors of type  $I_n$  correspond to sub-algebras of  $\mathcal{B}(\mathcal{H})$  associated with infinite-dimensional Hilbert space and  $I_\infty$  to  $\mathcal{B}(\mathcal{H})$  itself. These factors appear in the standard quantum measurement theory where state function reduction can lead to a ray of Hilbert space.
2. For factors of type II no minimal projectors exists whereas finite projectors exist. For factors of type  $II_1$  all projectors have trace not larger than one and the trace varies in the range  $(0, 1]$ . In this case cyclic vectors  $\Omega$  exist. State function reduction can lead only to an infinite-dimensional

subspace characterized by a projector with trace smaller than 1 but larger than zero. The natural interpretation would be in terms of finite measurement resolution. The tensor product of  $II_1$  factor and  $I_\infty$  is  $II_\infty$  factor for which the trace for a projector can have arbitrarily large values.  $II_1$  factor has a unique finite tracial state and the set of traces of projections spans unit interval. There is uncountable number of factors of type II but hyper-finite factors of type  $II_1$  are the exceptional ones and physically most interesting.

3. Factors of type III correspond to an extreme situation. In this case the projection operators  $E$  spanning the factor have either infinite or vanishing trace and there exists an isometry mapping  $E\mathcal{H}$  to  $\mathcal{H}$  meaning that the projection operator spans almost all of  $\mathcal{H}$ . All projectors are also related to each other by isometry. Factors of type III are smallest if the factors are regarded as sub-algebras of a fixed  $\mathcal{B}(\mathcal{H})$  where  $\mathcal{H}$  corresponds to isomorphism class of Hilbert spaces. Situation changes when one speaks about concrete representations. Also now hyper-finite factors are exceptional.
4. Von Neumann algebras define a non-commutative measure theory. Commutative von Neumann algebras indeed reduce to  $L^\infty(X)$  for some measure space  $(X, \mu)$  and vice versa.

**Weights, states and traces**

The notions of weight, state, and trace are standard notions in the theory of von Neumann algebras.

1. A weight of von Neumann algebra is a linear map from the set of positive elements (those of form  $a^*a$ ) to non-negative reals.
2. A positive linear functional is weight with  $\omega(1)$  finite.
3. A state is a weight with  $\omega(1) = 1$ .
4. A trace is a weight with  $\omega(aa^*) = \omega(a^*a)$  for all  $a$ .
5. A tracial state is a weight with  $\omega(1) = 1$ .

A factor has a trace such that the trace of a non-zero projector is non-zero and the trace of projection is infinite only if the projection is infinite. The trace is unique up to a rescaling. For factors that are separable or finite, two projections are equivalent if and only if they have the same trace. Factors of type  $I_n$  the values of trace are equal to multiples of  $1/n$ . For a factor of type  $I_\infty$  the value of trace are  $0, 1, 2, \dots$ . For factors of type  $II_1$  the values span the range  $[0, 1]$  and for factors of type  $II_\infty$  in the range  $[0, \infty)$ . For factors of type III the values of the trace are  $0$ , and  $\infty$ .

**Tomita-Takesaki theory**

Tomita-Takesaki theory is a vital part of the theory of factors. First some definitions.

1. Let  $\omega(x)$  be a faithful state of von Neumann algebra so that one has  $\omega(xx^*) > 0$  for  $x > 0$ . Assume by Riesz lemma the representation of  $\omega$  as a vacuum expectation value:  $\omega = (\cdot\Omega, \Omega)$ , where  $\Omega$  is cyclic and separating state.
2. Let

$$L^\infty(\mathcal{M}) \equiv \mathcal{M} \ , \quad L^2(\mathcal{M}) = \mathcal{H} \ , \quad L^1(\mathcal{M}) = \mathcal{M}_* \ , \tag{13.7.1}$$

where  $\mathcal{M}_*$  is the pre-dual of  $\mathcal{M}$  defined by linear functionals in  $\mathcal{M}$ . One has  $\mathcal{M}_*^* = \mathcal{M}$ .

3. The conjugation  $x \rightarrow x^*$  is isometric in  $\mathcal{M}$  and defines a map  $\mathcal{M} \rightarrow L^2(\mathcal{M})$  via  $x \rightarrow x\Omega$ . The map  $S_0: x\Omega \rightarrow x^*\Omega$  is however non-isometric.

4. Denote by  $S$  the closure of the anti-linear operator  $S_0$  and by  $S = J\Delta^{1/2}$  its polar decomposition analogous that for complex number and generalizing polar decomposition of linear operators by replacing (almost) unitary operator with anti-unitary  $J$ . Therefore  $\Delta = S^*S > 0$  is positive self-adjoint and  $J$  an anti-unitary involution. The non-triviality of  $\Delta$  reflects the fact that the state is not trace so that hermitian conjugation represented by  $S$  in the state space brings in additional factor  $\Delta^{1/2}$ .
5. What  $x$  can be is puzzling to physicists. The restriction fermionic Fock space and thus to creation operators would imply that  $\Delta$  would act non-trivially only vacuum state so that  $\Delta > 0$  condition would not hold true. The resolution of puzzle is the allowance of tensor product of Fock spaces for which vacua are conjugates: only this gives cyclic and separating state. This is natural in zero energy ontology.

The basic results of Tomita-Takesaki theory are following.

1. The basic result can be summarized through the following formulas

$$\Delta^{it}M\Delta^{-it} = \mathcal{M} \quad , \quad JMJ = \mathcal{M}' \quad .$$

2. The latter formula implies that  $\mathcal{M}$  and  $\mathcal{M}'$  are isomorphic algebras. The first formula implies that a one parameter group of modular automorphisms characterizes partially the factor. The physical meaning of modular automorphisms is discussed in [?, ?]  $\Delta$  is Hermitian and positive definite so that the eigenvalues of  $\log(\Delta)$  are real but can be negative.  $\Delta^{it}$  is however not unitary for factors of type II and III. Physically the non-unitarity must relate to the fact that the flow is contracting so that hermiticity as a local condition is not enough to guarantee unitarity.
3.  $\omega \rightarrow \sigma_t^\omega = Ad\Delta^{it}$  defines a canonical evolution -modular automorphism- associated with  $\omega$  and depending on it. The  $\Delta$ :s associated with different  $\omega$ :s are related by a unitary inner automorphism so that their equivalence classes define an invariant of the factor.

Tomita-Takesaki theory gives rise to a non-commutative measure theory which is highly non-trivial. In particular the spectrum of  $\Delta$  can be used to classify the factors of type II and III.

### Modular automorphisms

Modular automorphisms of factors are central for their classification.

1. One can divide the automorphisms to inner and outer ones. Inner automorphisms correspond to unitary operators obtained by exponentiating Hermitian Hamiltonian belonging to the factor and connected to identity by a flow. Outer automorphisms do not allow a representation as a unitary transformations although  $\log(\Delta)$  is formally a Hermitian operator.
2. The fundamental group of the type  $II_1$  factor defined as fundamental group group of corresponding  $II_\infty$  factor characterizes partially a factor of type  $II_1$ . This group consists real numbers  $\lambda$  such that there is an automorphism scaling the trace by  $\lambda$ . Fundamental group typically contains all reals but it can be also discrete and even trivial.
3. Factors of type III allow a one-parameter group of modular automorphisms, which can be used to achieve a partial classification of these factors. These automorphisms define a flow in the center of the factor known as flow of weights. The set of parameter values  $\lambda$  for which  $\omega$  is mapped to itself and the center of the factor defined by the identity operator (projector to the factor as a sub-algebra of  $\mathcal{B}(\mathcal{H})$ ) is mapped to itself in the modular automorphism defines the Connes spectrum of the factor. For factors of type  $III_\lambda$  this set consists of powers of  $\lambda < 1$ . For factors of type  $III_0$  this set contains only identity automorphism so that there is no periodicity. For factors of type  $III_1$  Connes spectrum contains all real numbers so that the automorphisms do not affect the identity operator of the factor at all.

The modules over a factor correspond to separable Hilbert spaces that the factor acts on. These modules can be characterized by M-dimension. The idea is roughly that complex rays are replaced by the sub-spaces defined by the action of  $\mathcal{M}$  as basic units. M-dimension is not integer valued in general. The so called standard module has a cyclic separating vector and each factor has a standard representation possessing antilinear involution  $J$  such that  $\mathcal{M}' = J\mathcal{M}J$  holds true (note that  $J$  changes the order of the operators in conjugation). The inclusions of factors define modules having interpretation in terms of a finite measurement resolution defined by  $\mathcal{M}$ .

### Crossed product as a manner to construct factors of type III

By using so called crossed product [?] for a group  $G$  acting in algebra  $A$  one can obtain new von Neumann algebras. One ends up with crossed product by a two-step generalization by starting from the semidirect product  $G \triangleleft H$  for groups defined as  $(g_1, h_1)(g_2, h_2) = (g_1 h_1(g_2), h_1 h_2)$  (note that Poincare group has interpretation as a semidirect product  $M^4 \triangleleft SO(3, 1)$  of Lorentz and translation groups). At the first step one replaces the group  $H$  with its group algebra. At the second step the the group algebra is replaced with a more general algebra. What is formed is the semidirect product  $A \triangleleft G$  which is sum of algebras  $Ag$ . The product is given by  $(a_1, g_1)(a_2, g_2) = (a_1 g_1(a_2), g_1 g_2)$ . This construction works for both locally compact groups and quantum groups. A not too highly educated guess is that the construction in the case of quantum groups gives the factor  $\mathcal{M}$  as a crossed product of the included factor  $\mathcal{N}$  and quantum group defined by the factor space  $\mathcal{M}/\mathcal{N}$ .

The construction allows to express factors of type III as crossed products of factors of type  $II_\infty$  and the 1-parameter group  $G$  of modular automorphisms assignable to any vector which is cyclic for both factor and its commutant. The ergodic flow  $\theta_\lambda$  scales the trace of projector in  $II_\infty$  factor by  $\lambda > 0$ . The dual flow defined by  $G$  restricted to the center of  $II_\infty$  factor does not depend on the choice of cyclic vector.

The Connes spectrum - a closed subgroup of positive reals - is obtained as the exponent of the kernel of the dual flow defined as set of values of flow parameter  $\lambda$  for which the flow in the center is trivial. Kernel equals to  $\{0\}$  for  $III_0$ , contains numbers of form  $\log(\lambda)Z$  for factors of type  $III_\lambda$  and contains all real numbers for factors of type  $III_1$  meaning that the flow does not affect the center.

### 13.7.2 Inclusions and Connes tensor product

Inclusions  $\mathcal{N} \subset \mathcal{M}$  of von Neumann algebras have physical interpretation as a mathematical description for sub-system-system relation. For type  $I$  algebras the inclusions are trivial and tensor product description applies as such. For factors of  $II_1$  and  $III$  the inclusions are highly non-trivial. The inclusion of type  $II_1$  factors were understood by Vaughan Jones [?] and those of factors of type  $III$  by Alain Connes [?].

Formally sub-factor  $\mathcal{N}$  of  $\mathcal{M}$  is defined as a closed \*-stable C-subalgebra of  $\mathcal{M}$ . Let  $\mathcal{N}$  be a sub-factor of type  $II_1$  factor  $\mathcal{M}$ . Jones index  $\mathcal{M} : \mathcal{N}$  for the inclusion  $\mathcal{N} \subset \mathcal{M}$  can be defined as  $\mathcal{M} : \mathcal{N} = \dim_{\mathcal{N}}(L^2(\mathcal{M})) = \text{Tr}_{\mathcal{N}'}(\text{id}_{L^2(\mathcal{M})})$ . One can say that the dimension of completion of  $\mathcal{M}$  as  $\mathcal{N}$  module is in question.

#### Basic findings about inclusions

What makes the inclusions non-trivial is that the position of  $\mathcal{N}$  in  $\mathcal{M}$  matters. This position is characterized in case of hyper-finite  $II_1$  factors by index  $\mathcal{M} : \mathcal{N}$  which can be said to the dimension of  $\mathcal{M}$  as  $\mathcal{N}$  module and also as the inverse of the dimension defined by the trace of the projector from  $\mathcal{M}$  to  $\mathcal{N}$ . It is important to notice that  $\mathcal{M} : \mathcal{N}$  does not characterize either  $\mathcal{M}$  or  $\mathcal{N}$ , only the imbedding.

The basic facts proved by Jones are following [?].

1. For pairs  $\mathcal{N} \subset \mathcal{M}$  with a finite principal graph the values of  $\mathcal{M} : \mathcal{N}$  are given by

$$\begin{aligned} a) \quad \mathcal{M} : \mathcal{N} &= 4\cos^2(\pi/h) \quad , \quad h \geq 3 \quad , \\ b) \quad \mathcal{M} : \mathcal{N} &\geq 4 \quad . \end{aligned} \tag{13.7.2}$$



the numbers at right hand side are known as Beraha numbers [?] . The comments below give a rough idea about what finiteness of principal graph means.

- As explained in [?] , for  $\mathcal{M} : \mathcal{N} < 4$  one can assign to the inclusion Dynkin graph of ADE type Lie-algebra  $g$  with  $h$  equal to the Coxeter number  $h$  of the Lie algebra given in terms of its dimension and dimension  $r$  of Cartan algebra  $r$  as  $h = (\dim g - r)/r$ . The Lie algebras of  $SU(n)$ ,  $E_7$  and  $D_{2n+1}$  are however not allowed. For  $\mathcal{M} : \mathcal{N} = 4$  one can assign to the inclusion an extended Dynkin graph of type ADE characterizing Kac Moody algebra. Extended ADE diagrams characterize also the subgroups of  $SU(2)$  and the interpretation proposed in [?] is following. The ADE diagrams are associated with the  $n = \infty$  case having  $\mathcal{M} : \mathcal{N} \geq 4$ . There are diagrams corresponding to infinite subgroups:  $SU(2)$  itself, circle group  $U(1)$ , and infinite dihedral groups (generated by a rotation by a non-rational angle and reflection. The diagrams corresponding to finite subgroups are extension of  $A_n$  for cyclic groups, of  $D_n$  dihedral groups, and of  $E_n$  with  $n=6,7,8$  for tetrahedron, cube, dodecahedron. For  $\mathcal{M} : \mathcal{N} < 4$  ordinary Dynkin graphs of  $D_{2n}$  and  $E_6, E_8$  are allowed.

### Connes tensor product

The inclusions The basic idea of Connes tensor product is that a sub-space generated sub-factor  $\mathcal{N}$  takes the role of the complex ray of Hilbert space. The physical interpretation is in terms of finite measurement resolution: it is not possible to distinguish between states obtained by applying elements of  $\mathcal{N}$ .

Intuitively it is clear that it should be possible to decompose  $\mathcal{M}$  to a tensor product of factor space  $\mathcal{M}/\mathcal{N}$  and  $\mathcal{N}$ :

$$\mathcal{M} = \mathcal{M}/\mathcal{N} \otimes \mathcal{N} . \quad (13.7.3)$$

One could regard the factor space  $\mathcal{M}/\mathcal{N}$  as a non-commutative space in which each point corresponds to a particular representative in the equivalence class of points defined by  $\mathcal{N}$ . The connections between quantum groups and Jones inclusions suggest that this space closely relates to quantum groups. An alternative interpretation is as an ordinary linear space obtained by mapping  $\mathcal{N}$  rays to ordinary complex rays. These spaces appear in the representations of quantum groups. Similar procedure makes sense also for the Hilbert spaces in which  $\mathcal{M}$  acts.

Connes tensor product can be defined in the space  $\mathcal{M} \otimes \mathcal{M}$  as entanglement which effectively reduces to entanglement between  $\mathcal{N}$  sub-spaces. This is achieved if  $\mathcal{N}$  multiplication from right is equivalent with  $\mathcal{N}$  multiplication from left so that  $\mathcal{N}$  acts like complex numbers on states. One can imagine variants of the Connes tensor product and in TGD framework one particular variant appears naturally as will be found.

In the finite-dimensional case Connes tensor product of Hilbert spaces has a rather simple representation. If the matrix algebra  $N$  of  $n \times n$  matrices acts on  $V$  from right,  $V$  can be regarded as a space formed by  $m \times n$  matrices for some value of  $m$ . If  $N$  acts from left on  $W$ ,  $W$  can be regarded as space of  $n \times r$  matrices.

- In the first representation the Connes tensor product of spaces  $V$  and  $W$  consists of  $m \times r$  matrices and Connes tensor product is represented as the product  $VW$  of matrices as  $(VW)_{mr} e^{mr}$ . In this representation the information about  $N$  disappears completely as the interpretation in terms of measurement resolution suggests. The sum over intermediate states defined by  $N$  brings in mind path integral.
- An alternative and more physical representation is as a state

$$\sum_n V_{mn} W_{nr} e^{mn} \otimes e^{nr}$$

in the tensor product  $V \otimes W$ .

3. One can also consider two spaces  $V$  and  $W$  in which  $N$  acts from right and define Connes tensor product for  $A^\dagger \otimes_N B$  or its tensor product counterpart. This case corresponds to the modification of the Connes tensor product of positive and negative energy states. Since Hermitian conjugation is involved, matrix product does not define the Connes tensor product now. For  $m = r$  case entanglement coefficients should define a unitary matrix commuting with the action of the Hermitian matrices of  $N$  and interpretation would be in terms of symmetry. HFF property would encourage to think that this representation has an analog in the case of HFFs of type  $II_1$ .
4. Also type  $I_n$  factors are possible and for them Connes tensor product makes sense if one can assign the inclusion of finite-D matrix algebras to a measurement resolution.

### 13.7.3 Factors in quantum field theory and thermodynamics

Factors arise in thermodynamics and in quantum field theories [?, ?, ?]. There are good arguments showing that in HFFS of  $III_1$  appear are relativistic quantum field theories. In non-relativistic QFTs the factors of type I appear so that the non-compactness of Lorentz group is essential. Factors of type  $III_1$  and  $III_\lambda$  appear also in relativistic thermodynamics.

The geometric picture about factors is based on open subsets of Minkowski space. The basic intuitive view is that for two subsets of  $M^4$ , which cannot be connected by a classical signal moving with at most light velocity, the von Neumann algebras commute with each other so that  $\vee$  product should make sense.

Some basic mathematical results of algebraic quantum field theory [?] deserve to be listed since they are suggestive also from the point of view of TGD.

1. Let  $\mathcal{O}$  be a bounded region of  $R^4$  and define the region of  $M^4$  as a union  $\cup_{|x|<\epsilon}(\mathcal{O} + x)$  where  $(\mathcal{O} + x)$  is the translate of  $\mathcal{O}$  and  $|x|$  denotes Minkowski norm. Then every projection  $E \in \mathcal{M}(\mathcal{O})$  can be written as  $WW^*$  with  $W \in \mathcal{M}(\mathcal{O}_\epsilon)$  and  $W^*W = 1$ . Note that the union is not a bounded set of  $M^4$ . This almost establishes the type III property.
2. Both the complement of light-cone and double light-cone define HFF of type  $III_1$ . Lorentz boosts induce modular automorphisms.
3. The so called split property suggested by the description of two systems of this kind as a tensor product in relativistic QFTs is believed to hold true. This means that the HFFs of type  $III_1$  associated with causally disjoint regions are sub-factors of factor of type  $I_\infty$ . This means

$$\mathcal{M}_1 \subset \mathcal{B}(\mathcal{H}_1) \times 1 \quad , \quad \mathcal{M}_2 \subset 1 \otimes \mathcal{B}(\mathcal{H}_2) \quad .$$

An infinite hierarchy of inclusions of HFFS of type  $III_1$ s is induced by set theoretic inclusions.

### 13.7.4 TGD and factors

The following vision about TGD and factors relies heavily on zero energy ontology, TGD inspired quantum measurement theory, basic vision about quantum TGD, and bosonic emergence.

#### The problems

Concerning the role of factors in TGD framework there are several problems of both conceptual and technical character.

#### 1. Conceptual problems

It is safest to start from the conceptual problems and take a role of skeptic.

1. Under what conditions the assumptions of Tomita-Takesaki formula stating the existence of modular automorphism and isomorphy of the factor and its commutant hold true? What is the physical interpretation of the formula  $\mathcal{M}' = J\mathcal{M}J$  relating factor and its commutant in TGD framework?

2. Is the identification  $M = \Delta^{it}$  sensible in quantum TGD and zero energy ontology, where M-matrix is "complex square root" of exponent of Hamiltonian defining thermodynamical state and the notion of unitary time evolution is given up? The notion of state  $\omega$  leading to  $\Delta$  is essentially thermodynamical and one can wonder whether one should take also a "complex square root" of  $\omega$  to get M-matrix giving rise to a genuine quantum theory.
3. TGD based quantum measurement theory involves both quantum fluctuating degrees of freedom assignable to light-like 3-surfaces and zero modes identifiable as classical degrees of freedom assignable to interior of the space-time sheet. Zero modes have also fermionic counterparts. State preparation should generate entanglement between the quantal and classical states. What this means at the level of von Neumann algebras?
4. What is the TGD counterpart for causal disjointness. At space-time level different space-time sheets could correspond to such regions whereas at imbedding space level causally disjoint  $CD$ s would represent such regions.

### 2. Technical problems

There are also more technical questions.

1. What is the von Neumann algebra needed in TGD framework? Does one have a direct integral over factors (at least a direct integral over zero modes labeling factors)? Which factors appear in it? Can one construct the factor as a crossed product of some group  $G$  with a direct physical interpretation and of naturally appearing factor  $A$ ? Is  $A$  a HFF of type  $II_\infty$ ? assignable to a fixed  $CD$ ? What is the natural Hilbert space  $\mathcal{H}$  in which  $A$  acts?
2. What are the geometric transformations inducing modular automorphisms of  $II_\infty$  inducing the scaling down of the trace? Is the action of  $G$  induced by the boosts in Lorentz group. Could also translations and scalings induce the action? What is the factor associated with the union of Poincare transforms of  $CD$ ?  $\log(\Delta)$  is Hermitian algebraically: what does the non-unitarity of  $\exp(\log(\Delta)it)$  mean physically?
3. Could  $\Omega$  correspond to a vacuum which in conformal degrees of freedom depends on the choice of the sphere  $S^2$  defining the radial coordinate playing the role of complex variable in the case of the radial conformal algebra. Does \*-operation in  $\mathcal{M}$  correspond to Hermitian conjugation for fermionic oscillator operators and change of sign of super conformal weights?

The exponent of the modified Dirac action gives rise to the exponent of Kähler function as Dirac determinant and fermionic inner product defined by fermionic Feynman rules. It is implausible that this exponent could as such correspond to  $\omega$  or  $\Delta^{it}$  having conceptual roots in thermodynamics rather than QFT. If one assumes that the exponent of the modified Dirac action defines a "complex square root" of  $\omega$  the situation changes. This raises technical questions relating to the notion of square root of  $\omega$ .

1. Does the square root of  $\omega$  in the have a polar decomposition to a product of positive definite matrix (square root of the density matrix) and unitary matrix and does  $\omega^{1/2}$  correspond to the modulus in the decomposition? Does the square root of  $\Delta$  have similar decomposition with modulus equal equal to  $\Delta^{1/2}$  in standard picture so that modular automorphism, which is inherent property of von Neumann algebra, would not be affected?
2.  $\Delta^{it}$  or rather its generalization is defined modulo a unitary operator defined by some Hamiltonian and is therefore highly non-unique as such. This non-uniqueness applies also to  $|\Delta|$ . Could this non-uniqueness correspond to the thermodynamical degrees of freedom?

### Zero energy ontology and factors

The first question concerns the identification of the Hilbert space associated with the factors in zero energy ontology. As the positive or negative energy part of the zero energy state space or as the entire space of zero energy states? The latter option would look more natural physically and is forced by the condition that the vacuum state is cyclic and separating.

1. The commutant of HFF given as  $\mathcal{M}' = JMJ$ , where  $J$  is involution transforming fermionic oscillator operators and bosonic vector fields to their Hermitian conjugates. Also conformal weights would change sign in the map which conforms with the view that the light-like boundaries of  $CD$  are analogous to upper and lower hemispheres of  $S^2$  in conformal field theory. The presence of  $J$  representing essentially Hermitian conjugation would suggest that positive and zero energy parts of zero energy states are related by this formula so that state space decomposes to a tensor product of positive and negative energy states and  $M$ -matrix can be regarded as a map between these two sub-spaces.
2. The fact that HFF of type  $II_1$  has the algebra of fermionic oscillator operators as a canonical representation makes the situation puzzling for a novice. The assumption that the vacuum is cyclic and separating means that neither creation nor annihilation operators can annihilate it. Therefore Fermionic Fock space cannot appear as the Hilbert space in the Tomita-Takesaki theorem. The paradox is circumvented if the action of  $*$  transforms creation operators acting on the positive energy part of the state to annihilation operators acting on negative energy part of the state. If  $J$  permutes the two Fock vacuums in their tensor product, the action of  $S$  indeed maps permutes the tensor factors associated with  $\mathcal{M}$  and  $\mathcal{M}'$ .

It is far from obvious whether the identification  $M = \Delta^{it}$  makes sense in zero energy ontology.

1. In zero energy ontology  $M$ -matrix defines time-like entanglement coefficients between positive and negative energy parts of the state.  $M$ -matrix is essentially "complex square root" of the density matrix and quantum theory similar square root of thermodynamics. The notion of state as it appears in the theory of HFFS is however essentially thermodynamical. Therefore it is good to ask whether the "complex square root of state" could make sense in the theory of factors.
2. Quantum field theory suggests an obvious proposal concerning the meaning of the square root: one replaces exponent of Hamiltonian with imaginary exponential of action at  $T \rightarrow 0$  limit. In quantum TGD the exponent of modified Dirac action giving exponent of Kähler function as real exponent could be the manner to take this complex square root. Modified Dirac action can therefore be regarded as a "square root" of Kähler action.
3. The identification  $M = \Delta^{it}$  relies on the idea of unitary time evolution which is given up in zero energy ontology based on  $CD$ s? Is the reduction of the quantum dynamics to a flow a realistic idea? As will be found this automorphism could correspond to a time translation or scaling for either upper or lower light-cone defining  $CD$  and can ask whether  $\Delta^{it}$  corresponds to the exponent of scaling operator  $L_0$  defining single particle propagator as one integrates over  $t$ . Its complex square root would correspond to fermionic propagator.
4. In this framework  $J\Delta^{it}$  would map the positive energy and negative energy sectors to each other. If the positive and negative energy state spaces can identified by isometry then  $M = J\Delta^{it}$  identification can be considered but seems unrealistic.  $S = J\Delta^{1/2}$  maps positive and negative energy states to each other: could  $S$  or its generalization appear in  $M$ -matrix as a part which gives thermodynamics? The exponent of the modified Dirac action does not seem to provide thermodynamical aspect and p-adic thermodynamics suggests strongly the presence exponent of  $\exp(-L_0/T_p)$  with  $T_p$  chose in such manner that consistency with p-adic thermodynamics is obtained. Could the generalization of  $J\Delta^{n/2}$  with  $\Delta$  replaced with its "square root" give rise to p-adic thermodynamics and also ordinary thermodynamics at the level of density matrix? The minimal option would be that power of  $\Delta^{it}$  which imaginary value of  $t$  is responsible for thermodynamical degrees of freedom whereas everything else is dictated by the unitary  $S$ -matrix appearing as phase of the "square root" of  $\omega$ .

### Zero modes and factors

The presence of zero modes justifies quantum measurement theory in TGD framework and the relationship between zero modes and HFFS involves further conceptual problems.

1. The presence of zero modes means that one has a direct integral over HFFs labeled by zero modes which by definition do not contribute to the configuration space line element. The realization

of quantum criticality in terms of modified Dirac action [K15] suggests that also fermionic zero mode degrees of freedom are present and correspond to conserved charges assignable to the critical deformations of the pace-time sheets. Induced Kähler form characterizes the values of zero modes for a given space-time sheet and the symplectic group of light-cone boundary characterizes the quantum fluctuating degrees of freedom. The entanglement between zero modes and quantum fluctuating degrees of freedom is essential for quantum measurement theory. One should understand this entanglement.

2. Physical intuition suggests that classical observables should correspond to longer length scale than quantal ones. Hence it would seem that the interior degrees of freedom outside  $CD$  should correspond to classical degrees of freedom correlating with quantum fluctuating degrees of freedom of  $CD$ .
3. Quantum criticality means that modified Dirac action allows an infinite number of conserved charges which correspond to deformations leaving metric invariant and therefore act on zero modes. Does this super-conformal algebra commute with the super-conformal algebra associated with quantum fluctuating degrees of freedom? Could the restriction of elements of quantum fluctuating currents to 3-D light-like 3-surfaces actually imply this commutativity. Quantum holography would suggest a duality between these algebras. Quantum measurement theory suggests even 1-1 correspondence between the elements of the two super-conformal algebras. The entanglement between classical and quantum degrees of freedom would mean that prepared quantum states are created by operators for which the operators in the two algebras are entangled in diagonal manner.
4. The notion of finite measurement resolution has become key element of quantum TGD and one should understand how finite measurement resolution is realized in terms of inclusions of hyper-finite factors for which sub-factor defines the resolution in the sense that its action creates states not distinguishable from each other in the resolution used. The notion of finite measurement resolution suggests that one should speak about entanglement between sub-factors and corresponding sub-spaces rather than between states. Connes tensor product would code for the idea that the action of sub-factors is analogous to that of complex numbers and tracing over sub-factor realizes this idea.
5. Just for fun one can ask whether the duality between zero modes and quantum fluctuating degrees of freedom representing quantum holography could correspond to  $\mathcal{M}' = J\mathcal{M}J$ ? This interpretation must be consistent with the interpretation forced by zero energy ontology. If this crazy guess is correct (very probably not!), both positive and negative energy states would be observed in quantum measurement but in totally different manner. Since this identity would simplify enormously the structure of the theory, it deserves therefore to be shown wrong.

### Crossed product construction in TGD framework

The identification of the von Neumann algebra by crossed product construction is the basic challenge. Consider first the question how HFFs of type  $II_\infty$  could emerge, how modular automorphisms act on them, and how one can understand the non-unitary character of the  $\Delta^{it}$  in an apparent conflict with the hermiticity and positivity of  $\Delta$ .

1. If the number of spinor modes is infinite, the Clifford algebra at a given point of  $WCW(CD)$  (light-like 3-surfaces with ends at the boundaries of  $CD$ ) defines HFF of type  $II_1$  or possibly a direct integral of them. For a given  $CD$  having compact isotropy group  $SO(3)$  leaving the rest frame defined by the tips of  $CD$  invariant the factor defined by Clifford algebra valued fields in  $WCW(CD)$  is most naturally HFF of type  $II_\infty$ . The Hilbert space in which this Clifford algebra acts, consists of spinor fields in  $WCW(CD)$ . Also the symplectic transformations of light-cone boundary leaving light-like 3-surfaces inside  $CD$  can be included to  $G$ . In fact all conformal algebras leaving  $CD$  invariant could be included in  $CD$ .
2. The downwards scalings of the radial coordinate  $r_M$  of the light-cone boundary applied to the basis of  $WCW(CD)$  spinor fields could induce modular automorphism. These scalings reduce the size of the portion of light-cone in which the  $WCW$  spinor fields are non-vanishing

and effectively scale down the size of  $CD$ .  $\exp(iL_0)$  as algebraic operator acts as a phase multiplication on eigen states of conformal weight and therefore as apparently unitary operator. The geometric flow however contracts the  $CD$  so that the interpretation of  $\exp(itL_0)$  as a unitary modular automorphism is not possible. The scaling down of  $CD$  reduces the value of the trace if it involves integral over the boundary of  $CD$ . A similar reduction is implied by the downward shift of the upper boundary of  $CD$  so that also time translations would induce modular automorphism. These shifts seem to be necessary to define rest energies of positive and negative energy parts of the zero energy state.

3. The non-triviality of the modular automorphisms of  $II_\infty$  factor reflects different choices of  $\omega$ . The degeneracy of  $\omega$  could be due to the non-uniqueness of conformal vacuum which is part of the definition of  $\omega$ . The radial Virasoro algebra of light-cone boundary is generated by  $L_n = L_{-n}^*$ ,  $n \neq 0$  and  $L_0 = L_0^*$  and negative and positive frequencies are in asymmetric position. The conformal gauge is fixed by the choice of  $SO(3)$  subgroup of Lorentz group defining the slicing of light-cone boundary by spheres and the tips of  $CD$  fix  $SO(3)$  uniquely. One can however consider also alternative choices of  $SO(3)$  and each corresponds to a slicing of the light-cone boundary by spheres but in general the sphere defining the intersection of the two light-cone does not belong to the slicing. Hence the action of Lorentz transformation inducing different choice of  $SO(3)$  can lead out from the preferred state space so that its representation must be non-unitary unless Virasoro generators annihilate the physical states. The non-vanishing of the conformal central charge  $c$  and vacuum weight  $h$  seems to be necessary and indeed can take place for super-symplectic algebra and Super Kac-Moody algebra since only the differences of the algebra elements are assumed to annihilate physical states.

The essential assumption in the above argument is that the number of modes  $D_K\Psi = 0$  for the induced spinor field is infinite. This assumption is highly non-trivial and need not hold true always as the detailed considerations of [?] demonstrate.

1. The Dirac determinant defining the vacuum functional is identified as the product of generalized eigenvalues of the 3-D dimensional reduction  $D_{K,3}$  of  $D_K$  to light-like 3-surfaces  $Y_l^3$ . A physical analogy for the modified Dirac equation is fermion in a magnetic field.
2. When the dimension  $D$  of the  $CP_2$  projection of the space-time sheet satisfies  $D > 2$ , the counterpart of the Schrödinger amplitude - call it  $R$ - can depend on single  $CP_2$  coordinate only. For  $D = 2$  (cosmic strings would be the basic example)  $R$  can depend on 2  $CP_2$  coordinates. In this case infinite number of modes are possible and are analogous to 2-D spherical harmonics in the cross section of the string like object. At least in the interior of cosmic strings this option seems to be realized so that in this case the Clifford algebra would be infinite-dimensional.
3. What is essential is that for string like objects the slicings by light-like 3-surfaces associated with the wormhole throats at the opposite ends of string like object can correspond to the same slicing. Hence the situation is expected to be the same for all string like objects irrespective of the value of  $D$ . The coordinate on which  $R$  depends could be analogous to cylindrical angle coordinate and one would have infinite number of rotational modes. For infinite-dimensional case zeta function regularization must be used in the definition of Dirac determinant and under rather general conditions on spectrum reduces to the analytic continuation used to define Riemann Zeta.
4. For  $D > 2$  and for objects which are not string like objects situation is different. The slicings by light-like 3-surfaces associated with different wormhole throats must be defined on finite-sized basins separated by boundaries at which the spinor modes associated with particular throat must vanish. The modes are therefore restricted to a finite region of space-time sheet with a boundary. If  $R$  is analogous to a radial mode in constant magnetic field, there is a natural cutoff in oscillator modes which are analogous harmonic oscillator wave functions and Dirac determinant is automatically finite. Thus for  $D > 2$  or at least for  $D = 4$ - a phase analogous to QFT in  $M^4$  - the number of modes would be finite meaning that the Clifford algebra is finite-dimensional and one obtains only factor of type  $I_n$ .

Modular automorphism of HFFs type  $III_1$  can be induced by several geometric transformations for HFFs of type  $III_1$  obtained using the crossed product construction from  $II_\infty$  factor by extending  $CD$  to a union of its Lorentz transforms.

1. The crossed product would correspond to an extension of  $II_\infty$  by allowing a union of some geometric transforms of  $CD$ . If one assumes that only  $CD$ s for which the distance between tips is quantized in powers of 2, then scalings of either upper or lower boundary of  $CD$  cannot correspond to these transformations. Same applies to time translations acting on either boundary but not to ordinary translations. As found, the modular automorphisms reducing the size of  $CD$  could act in HFF of type  $II_\infty$ .
2. The geometric counterparts of the modular transformations would most naturally correspond to any non-compact one parameter sub-group of Lorentz group as also QFT suggests. The Lorentz boosts would replace the radial coordinate  $r_M$  of the light-cone boundary associated with the radial Virasoro algebra with a new one so that the slicing of light-cone boundary with spheres would be affected and one could speak of a new conformal gauge. The temporal distance between tips of  $CD$  in the rest frame would not be affected. The effect would seem to be however unitary because the transformation does not only modify the states but also transforms  $CD$ .
3. Since Lorentz boosts affect the isotropy group  $SO(3)$  of  $CD$  and thus also the conformal gauge defining the radial coordinate of the light-cone boundary, they affect also the definition of the conformal vacuum so that also  $\omega$  is affected so that the interpretation as a modular automorphism makes sense. The simplistic intuition of the novice suggests that if one allows wave functions in the space of Lorentz transforms of  $CD$ , unitarity of  $\Delta^{it}$  is possible. Note that the hierarchy of Planck constants assigns to  $CD$  preferred  $M^2$  and thus direction of quantization axes of angular momentum and boosts in this direction would be in preferred role.
4. One can also consider the HFF of type  $III_\lambda$  if the radial scalings by negative powers of 2 correspond to the automorphism group of  $II_\infty$  factor as the vision about allowed  $CD$ s suggests.  $\lambda = 1/2$  would naturally hold true for the factor obtained by allowing only the radial scalings. Lorentz boosts would expand the factor to HFF of type  $III_1$ . Why scalings by powers of 2 would give rise to periodicity should be understood.

The identification of  $M$ -matrix as modular automorphism  $\Delta^{it}$ , where  $t$  is complex number having as its real part the temporal distance between tips of  $CD$  quantized as  $2^n$  and temperature as imaginary part, looks at first highly attractive, since it would mean that  $M$ -matrix indeed exists mathematically. The proposed interpretations of modular automorphisms do not support the idea that they could define the S-matrix of the theory. In any case, the identification as modular automorphism would not lead to a magic universal formula since arbitrary unitary transformation is involved.

### 13.7.5 Can one identify $M$ -matrix from physical arguments?

Consider next the identification of  $M$ -matrix from physical arguments.

#### Basic physical picture

The following physical picture could help in the attempt to guess what the complex square root of  $\omega$  is and also whether this idea makes sense at all. Consider first quantum TGD proper.

1. The exponent of Kähler function identified as Kähler action for preferred extremals defines the bosonic vacuum functional appearing in the functional integral over  $WCW(CD)$ . The exponent of Kähler function depends on the real part of  $t$  identified as Minkowski distance between the tips of  $CD$ . This dependence is not consistent with the dependence of  $\Delta^{it}$  on  $t$  and the natural interpretation is that the vacuum functional can be included in the definition of the inner product for spinors fields of  $WCW$ . More formally, the exponent of Kähler function defines  $\omega$  in bosonic degrees of freedom.
2. One can assign to the modified Dirac action Dirac determinant identified tentatively as the exponent of Kähler function. This determinant is defined as the product of the generalized eigenvalues of a 3-dimensional modified Dirac operator assignable to light-like 3-surfaces. The definition relies on quantum holography involving the slicing of space-time surface both by light-like 3-surfaces and by string world sheets. Hence also Kähler coupling strength follows as a prediction so that the theory involves therefore no free coupling parameters. Kähler function

is defined only apart from an additive term which is sum of holomorphic and anti-holomorphic functions of the configuration space and this would naturally correspond to the effect of the modular automorphism. I have proposed that the choices of a particular light-like 3-surface in the slicing of  $X^4$  by light-like 3-surfaces at which vacuum functional is defined as Dirac determinant can differ by this kind of term having therefore interpretation also as a modular automorphism for a factor of type  $\text{II}_\infty$ .

3. Quantum criticality -implied by the condition that the modified Dirac action gives rise to conserved currents assignable to the deformations of the space-time surface - means the vanishing of the second variation of Kähler action for these deformations. Preferred extremals correspond to these 4-surfaces and  $M^8 - M^4 \times CP_2$  duality allows to identify them also as hyper-quaternionic space-time surfaces.
4. Second quantized spinor fields are the only quantum fields appearing at the space-time level. This justifies to the notion of bosonic emergence [?] , which means that gauge bosons and possible counterpart of Higgs particle are identified as bound states of fermion and antifermion at opposite light-like throats of wormhole contact. This suggests that the  $M$ -matrix should allow a formulation solely in terms of the modified Dirac action.

### HFFs and the definition of Dirac determinant

The definition of the Dirac determinant -call it  $\det(D)$ - discussed in [K15] involves two assumptions. First, finite measurement resolution is assumed to correspond to a replacement of light-like 3-surfaces with braids whose strands carry fermion number. Secondly, the quantum holography justifies the assumption about dimensional reduction to a determinant assignable to 3-D Dirac operator.

1. The finiteness of the trace for HFF of type  $\text{II}_1$  indeed encourages the question whether one could define  $\det(D)$  as the exponent of the trace of the logarithm of 3-D Dirac operator  $D_3$  even without the assumption of finite measurement resolution. The trace would be induced from the trace of the tensor product of hyper-finite factor of type  $\text{II}_1$  and factor of type I.
2. One might wonder whether holography could allow to define  $\det(D)$  also in terms of the 4-D modified Dirac operator. The basic problem is of course that only the spinor fields satisfying  $D_4\Psi = 0$  are allowed and eigenvalue equation in standard sense breaks baryon and lepton number conservation. The critical deformation representing zero modes might however allow to circumvent this difficulty. The modified Dirac equation  $D\Psi = 0$  holding true for the 4-surfaces obtained as critical deformations can be written in the form  $D_0\Psi = D_0\delta\Psi = -\delta D\Psi$ , where the subscript  $_0$  refers to the non-deformed surface and one has  $\delta\Psi = O\Psi_0$  which involves propagator defined by  $D_4$ . Maybe one could define  $\det(D)$  as the determinant of the operator  $-\delta D$  by identifying it as the exponent of the trace of the operator  $\log(-\delta D)$ . This would require a division by the deformation parameter  $\delta t$  at both sides of the modified Dirac equation and means only the elimination of an infinite proportionality factor from the determinant.

### Bosonic emergence and QFT limit of TGD

The QFT limit of TGD gives further valuable hints about the formulation of quantum TGD proper. In QFT limit Dirac action coupled to gauge potentials (and possibly the TGD counterpart of Higgs) defines the theory and bosonic propagators and vertices involving bosons as external particles emerge as radiative corrections [?] . There are no free coupling constants in the theory.

1. The construction involves at the first step the coupling of spinor fields  $\Psi$  to fermionic sources  $\xi$  leading to an expression of the effective action as a functional of gauge potentials and  $\xi$  containing the counterpart of YM action in the purely bosonic sector plus interaction terms representing N-boson vertices. Bosonic dynamics is therefore generated purely radiatively in accordance with the emergence idea. At the next step the coupling to external YM currents leads to Feynman rules in the standard manner.
2. The inverse of the bosonic propagator and N-boson vertices correspond to fermionic loops and coupling constants are predicted completely in terms of them provided one can define the loop integrals uniquely.



3. Fermionic loops do not make sense without cutoff in both mass squared and hyperbolic angle defining the maximum Lorentz boost which can be applied to a virtual fermion in the rest system of the virtual gauge boson. Zero energy ontology realized in terms of a hierarchy of *CDs* provides a physical justification for the hierarchy of hyperbolic cutoffs. p-Adic length scale hypothesis (the sizes of *CDs* come in powers of 2) allows to decompose momentum space to shells corresponding to mass squared intervals  $[n, n + 1)$  using  $CP_2$  mass squared as a unit. The hyperbolic cutoff can depend on p-adic mass scale and can differ for time-like and space-like momenta: the relationship between these cutoffs is fixed from the condition that gauge bosons do not generate mass radiatively. One can find a simple ansatz for the hyperbolic cutoff consistent with the coupling constant evolution in standard model. The vanishing of all on-mass-shell  $N > 2$ -boson vertices defined by the fermionic loops states their irreducibility to lower vertices and serves as a candidate for the condition fixing the hyperbolic cutoff as a function of the p-adic mass scale.

### A proposal for *M*-matrix

This picture can be taken as a template as one tries to imagine how the construction of *M*-matrix could proceed in quantum TGD proper.

1. Modified Dirac action should replace the ordinary Dirac action and define the theory. The linear couplings of spinors to fermionic external currents are needed. Also bosons represented as bound states of fermion and antifermion to the analogs of gauge currents are needed to construct the *M*-matrix and would correspond to an addition of quantum part to induced spinor connection. One can consider also the addition of quantum parts to the induced metric and induced gamma matrices.
2. The couplings of the induced spinor fields to external sources would be given as contractions of the fermionic sources with conformal super-currents. Conformal currents would couple to bosonic external currents analogous to external YM currents and *M*-matrix would result via the usual procedure leading to generalized Feynman diagrams for which sub-*CDs* would contain vertices.

One cannot however argue that everything would be crystal clear.

1. There are two kinds of super-conformal algebras corresponding to quantum fluctuating degrees of freedom and zero modes. The super-conformal algebra associated with the zero modes follows from quantum criticality guaranteeing the conservation of these currents. These currents are defined in the interior of the space-time surface. By quantum holography the quantum fluctuating super-conformal algebra is assigned with light-like 3-surfaces. Both these algebras form a hierarchy of inclusions identifiable as counterparts for inclusions of HFFs. Which of the two super-conformal algebras one should use? Does quantum holography - interpreted as possibility of 1-1 entanglement between the two kinds of conformal currents for prepared states- mean that one can use either of them to construct *M*-matrix? How the dimensional reduction could be understood in terms of this duality?
2. The bosonic conserved currents in the interior of  $X^4$  implied by quantum criticality involve a purely local pairing of the induced spinor field and its conjugate. The problem is that gauge bosons as wormhole throats appearing in the dimensionally reduced description correspond to a non-local (in  $CP_2$  scale) pairing of spinor field and its conjugate at opposite wormhole throats. Should one accept as a fact that dimensionally reduced quantum fluctuating counterparts for the purely local zero mode currents are bi-local?
3. Only few days after posing these questions a plausible answer to them came through a resolution of several problems related to the formulation of quantum TGD (see the section "Handful of problems with a common resolution" of [?]). One important outcome of the formulation allowing to understand how stringy fermionic propagators emerge from the theory was that gravitational coupling vanishes for purely local composites of fermion and antifermion represented by Kac-Moody algebra and super-conformal algebra associated with critical deformations. Hence the only sensible identification of bosons seems to be as wormhole throats.

4. The construction of the bosonic propagators in terms of fermionic loops [?] as functionals integral over Grassmann variables generalizes. Fermionic loops correspond geometrically to wormhole contacts having fermion and anti-fermion at their opposite light-like throats. This implies a cutoff for momentum squared and hyperbolic angle of the virtual fermion in the rest system of boson crucial for the absence of loop divergences. Hence bosonic propagation is emergent as is also fermionic propagation which can be seen as induced by the measurement interaction for momentum. This justifies the cutoffs due to the finite measurement resolution.
5. It is essential that one first functionally integrates over the fermionic degrees of freedom and over the small deformations of light-like 3-surfaces and only after that constructs diagrams from tree diagrams with bosonic and fermionic lines by using generalized Cutkosky rules. Here the generalization of twistors to 8-D context allowing to regard massive particles as massless particles in 8-D framework is expected to be a crucial technical tool possibly allowing to achieve summations over large classes of generalized Feynman diagrams. Also the hierarchy of *CDs* is expected to be crucial in the construction.

The key idea is the addition of measurement interaction term to the modified Dirac action coupling to the conserved currents defined by quantum critical deformations for which the second variation of Kähler action vanishes. There remains a considerable freedom in choosing the precise form of the measurement interaction but there is a long list of arguments supporting the identification of the measurement interaction as the one defined by 3-D Chern-Simons term assignable with wormhole throats so that the dynamics in the interior of space-time sheet is not affected. This means that 3-D light-like wormhole throats carry induced spinor field which can be regarded as independent degrees of freedom having the spinor fields at partonic 2-surfaces as sources and acting as 3-D sources for the 4-D induced spinor field. The most general measurement interaction would involve the corresponding coupling also for Kähler action but is not physically motivated. Here are the arguments in favor of Chern-Simons Dirac action and corresponding measurement interaction.

1. A correlation between 4-D geometry of space-time sheet and quantum numbers is achieved by the identification of exponent of Kähler function as Dirac determinant making possible the entanglement of classical degrees of freedom in the interior of space-time sheet with quantum numbers.
2. Cartan algebra plays a key role not only at quantum level but also at the level of space-time geometry since quantum critical conserved currents vanish for Cartan algebra of isometries and the measurement interaction terms giving rise to conserved currents are possible only for Cartan algebras. Furthermore, modified Dirac equation makes sense only for eigen states of Cartan algebra generators. The hierarchy of Planck constants realized in terms of the book like structure of the generalized imbedding space assigns to each *CD* (causal diamond) preferred Cartan algebra: in case of Poincare algebra there are two of them corresponding to linear and cylindrical  $M^4$  coordinates.
3. Quantum holography and dimensional reduction hierarchy in which partonic 2-surface defined fermionic sources for 3-D fermionic fields at light-like 3-surfaces  $Y_l^3$  in turn defining fermionic sources for 4-D spinors find an elegant realization. Effective 2-dimensionality is achieved if the replacement of light-like wormhole throat  $X_l^3$  with light-like 3-surface  $Y_l^3$  "parallel" with it in the definition of Dirac determinant corresponds to the  $U(1)$  gauge transformation  $K \rightarrow K + f + \bar{f}$  for Kähler function of WCW so that WCW Kähler metric is not affected. Here  $f$  is holomorphic function of WCW ("world of classical worlds") complex coordinates and arbitrary function of zero mode coordinates.
4. An elegant description of the interaction between super-conformal representations realized at partonic 2-surfaces and dynamics of space-time surfaces is achieved since the values of Cartan charges are feeded to the 3-D Dirac equation which also receives mass term at the same time. Almost topological QFT at wormhole throats results at the limit when four-momenta vanish: this is in accordance with the original vision about TGD as almost topological QFT.
5. A detailed view about the physical role of quantum criticality results. Quantum criticality fixes the values of Kähler coupling strength as the analog of critical temperature. Quantum

criticality implies that second variation of Kähler action vanishes for critical deformations and the existence of conserved current except in the case of Cartan algebra of isometries. Quantum criticality allows to fix the values of couplings appearing in the measurement interaction by using the condition  $K \rightarrow K + f + \bar{f}$ . p-Adic coupling constant evolution can be understood also and corresponds to scale hierarchy for the sizes of causal diamonds (CDs). To achieve internal consistency the quantum critical deformations for Kähler action must be also quantum critical for Chern-Simons action which implies that the deformations are orthogonal to Kähler magnetic field at each light-like 3-surface in the slicing of space-time sheet by light-like 3-surfaces.

6. CP breaking, irreversibility and the space-time description of dissipation are closely related. Also the interpretation of preferred extremals of Kähler action in regions where  $[D_{C-S}, D_{C-S,int}] = 0$  as asymptotic self organization patterns makes sense. Here  $D_{C-S}$  denotes the 3-D modified Dirac operator associated with Chern-Simons action and  $D_{C-S,int}$  to the corresponding measurement interaction term expressible as superposition of couplings to various observables to critical conserved currents.
7. A radically new view about matter antimatter asymmetry based on zero energy ontology emerges and one could understand the experimental absence of antimatter as being due to the fact antimatter corresponds to negative energy states. The identification of bosons as wormhole contacts is the only possible option in this framework.
8. Almost stringy propagators and a consistency with the identification of wormhole throats as lines of generalized Feynman diagrams is achieved. The notion of bosonic emergence leads to a long sought general master formula for the  $M$ -matrix elements. The counterpart for fermionic loop defining bosonic inverse propagator at QFT limit is wormhole contact with fermion and cutoffs in mass squared and hyperbolic angle for loop momenta of fermion and antifermion in the rest system of emitting boson have precise geometric counterpart.

On basis of above considerations it seems that the idea about "complex square root" of  $\omega$  might make sense in quantum TGD and that different measurement interactions correspond to various choices of  $\omega$ . Also the modular automorphism would make sense and because of its non-uniqueness  $\Delta$  could bring in the flexibility needed one wants thermodynamics. Stringy picture forces to ask whether  $\Delta$  could in some situation be proportional  $exp(L_0)$ , where  $L_0$  represents as the infinitesimal scaling generator of either super-symplectic algebra or super Kac-Moody algebra (the choice does not matter since the differences of the generators annihilate physical states in coset construction). This would allow to reproduce real thermodynamics consistent with p-adic thermodynamics.

In string models  $exp(iL_0\tau)$  is identified as the time evolution operator at single particle level whose integral over  $\tau$  defines the propagator. The quantization for the sizes of CDs does not however allow integration over  $t$  in this sense. Could the integration over projectors with traces differing by scalings parameterized by  $t$  correspond to this integral? Or should one give up this idea since modified Dirac operator defines a propagator in any case?

### 13.7.6 Finite measurement resolution and HFFs

The finite resolution of quantum measurement leads in TGD framework naturally to the notion of quantum  $M$ -matrix for which elements have values in sub-factor  $\mathcal{N}$  of HFF rather than being complex numbers.  $M$ -matrix in the factor space  $\mathcal{M}/\mathcal{N}$  is obtained by tracing over  $\mathcal{N}$ . The condition that  $\mathcal{N}$  acts like complex numbers in the tracing implies that  $M$ -matrix elements are proportional to maximal projectors to  $\mathcal{N}$  so that  $M$ -matrix is effectively a matrix in  $\mathcal{M}/\mathcal{N}$  and situation becomes finite-dimensional. It is still possible to satisfy generalized unitarity conditions but in general case tracing gives a weighted sum of unitary  $M$ -matrices defining what can be regarded as a square root of density matrix.

#### About the notion of observable in zero energy ontology

Some clarifications concerning the notion of observable in zero energy ontology are in order.

1. As in standard quantum theory observables correspond to hermitian operators acting on either positive or negative energy part of the state. One can indeed define hermitian conjugation for positive and negative energy parts of the states in standard manner.

2. Also the conjugation  $A \rightarrow JAJ$  is analogous to hermitian conjugation. It exchanges the positive and negative energy parts of the states also maps the light-like 3-surfaces at the upper boundary of  $CD$  to the lower boundary and vice versa. The map is induced by time reflection in the rest frame of  $CD$  with respect to the origin at the center of  $CD$  and has a well defined action on light-like 3-surfaces and space-time surfaces. This operation cannot correspond to the sought for hermitian conjugation since  $JAJ$  and  $A$  commute. The formulation of quantum TGD in terms of the modified Dirac action requires the addition of CP and T breaking fermionic counterpart of instanton term to the modified Dirac action. An interesting question is what this term means from the point of view of the conjugation.
3. Zero energy ontology gives Cartan sub-algebra of the Lie algebra of symmetries a special status. Only Cartan algebra acting on either positive or negative states respects the zero energy property but this is enough to define quantum numbers of the state. In absence of symmetry breaking positive and negative energy parts of the state combine to form a state in a singlet representation of group. Since only the net quantum numbers must vanish zero energy ontology allows a symmetry breaking respecting a chosen Cartan algebra.
4. In order to speak about four-momenta for positive and negative energy parts of the states one must be able to define how the translations act on  $CD$ s. The most natural action is a shift of the upper (lower) tip of  $CD$ . In the scale of entire  $CD$  this transformation induced Lorentz boost fixing the other tip. The value of mass squared is identified as proportional to the average of conformal weight in p-adic thermodynamics for the scaling generator  $L_0$  for either super-symplectic or Super Kac-Moody algebra.

#### Inclusion of HFFS as characterizer of finite measurement resolution at the level of $S$ -matrix

The inclusion  $\mathcal{N} \subset \mathcal{M}$  of factors characterizes naturally finite measurement resolution. This means following things.

1. Complex rays of state space resulting usually in an ideal state function reduction are replaced by  $\mathcal{N}$ -rays since  $\mathcal{N}$  defines the measurement resolution and takes the role of complex numbers in ordinary quantum theory so that non-commutative quantum theory results. Non-commutativity corresponds to a finite measurement resolution rather than something exotic occurring in Planck length scales. The quantum Clifford algebra  $\mathcal{M}/\mathcal{N}$  creates physical states modulo resolution. The fact that  $\mathcal{N}$  takes the role of gauge algebra suggests that it might be necessary to fix a gauge by assigning to each element of  $\mathcal{M}/\mathcal{N}$  a unique element of  $\mathcal{M}$ . Quantum Clifford algebra with fractal dimension  $\beta = \mathcal{M} : \mathcal{N}$  creates physical states having interpretation as quantum spinors of fractal dimension  $d = \sqrt{\beta}$ . Hence direct connection with quantum groups emerges.
2. The notions of unitarity, hermiticity, and eigenvalue generalize. The elements of unitary and hermitian matrices and  $\mathcal{N}$ -valued. Eigenvalues are Hermitian elements of  $\mathcal{N}$  and thus correspond entire spectra of Hermitian operators. The mutual non-commutativity of eigenvalues guarantees that it is possible to speak about state function reduction for quantum spinors. In the simplest case of a 2-component quantum spinor this means that second component of quantum spinor vanishes in the sense that second component of spinor annihilates physical state and second acts as element of  $\mathcal{N}$  on it. The non-commutativity of spinor components implies correlations between them and thus fractal dimension is smaller than 2.
3. The intuition about ordinary tensor products suggests that one can decompose  $\text{Tr}$  in  $\mathcal{M}$  as

$$\text{Tr}_{\mathcal{M}}(X) = \text{Tr}_{\mathcal{M}/\mathcal{N}} \times \text{Tr}_{\mathcal{N}}(X) . \quad (13.7.4)$$

Suppose one has fixed gauge by selecting basis  $|r_k\rangle$  for  $\mathcal{M}/\mathcal{N}$ . In this case one expects that operator in  $\mathcal{M}$  defines an operator in  $\mathcal{M}/\mathcal{N}$  by a projection to the preferred elements of  $\mathcal{M}$ .

$$\langle r_1|X|r_2\rangle = \langle r_1|\text{Tr}_{\mathcal{N}}(X)|r_2\rangle . \quad (13.7.5)$$

4. Scattering probabilities in the resolution defined by  $\mathcal{N}$  are obtained in the following manner. The scattering probability between states  $|r_1\rangle$  and  $|r_2\rangle$  is obtained by summing over the final states obtained by the action of  $\mathcal{N}$  from  $|r_2\rangle$  and taking the analog of spin average over the states created in the similar from  $|r_1\rangle$ .  $\mathcal{N}$  average requires a division by  $Tr(P_{\mathcal{N}}) = 1/\mathcal{M} : \mathcal{N}$  defining fractal dimension of  $\mathcal{N}$ . This gives

$$p(r_1 \rightarrow r_2) = \mathcal{M} : \mathcal{N} \times \langle r_1 | Tr_{\mathcal{N}}(SP_{\mathcal{N}}S^\dagger) | r_2 \rangle . \tag{13.7.6}$$

This formula is consistent with probability conservation since one has

$$\sum_{r_2} p(r_1 \rightarrow r_2) = \mathcal{M} : \mathcal{N} \times Tr_{\mathcal{N}}(SS^\dagger) = \mathcal{M} : \mathcal{N} \times Tr(P_{\mathcal{N}}) = 1 . \tag{13.7.7}$$

5. Unitarity at the level of  $\mathcal{M}/\mathcal{N}$  can be achieved if the unit operator  $Id$  for  $\mathcal{M}$  can be decomposed into an analog of tensor product for the unit operators of  $\mathcal{M}/\mathcal{N}$  and  $\mathcal{N}$  and  $M$  decomposes to a tensor product of unitary M-matrices in  $\mathcal{M}/\mathcal{N}$  and  $\mathcal{N}$ . For HFFs of type II projection operators of  $\mathcal{N}$  with varying traces are present and one expects a weighted sum of unitary M-matrices to result from the tracing having interpretation in terms of square root of thermodynamics.
6. This argument assumes that  $\mathcal{N}$  is HFF of type II<sub>1</sub> with finite trace. For HFFs of type III<sub>1</sub> this assumption must be given up. This might be possible if one compensates the trace over  $\mathcal{N}$  by dividing with the trace of the infinite trace of the projection operator to  $\mathcal{N}$ . This probably requires a limiting procedure which indeed makes sense for HFFs.

**Quantum  $M$ -matrix**

The description of finite measurement resolution in terms of inclusion  $\mathcal{N} \subset \mathcal{M}$  seems to boil down to a simple rule. Replace ordinary quantum mechanics in complex number field  $C$  with that in  $\mathcal{N}$ . This means that the notions of unitarity, hermiticity, Hilbert space ray, etc.. are replaced with their  $\mathcal{N}$  counterparts.

The full  $M$ -matrix in  $\mathcal{M}$  should be reducible to a finite-dimensional quantum  $M$ -matrix in the state space generated by quantum Clifford algebra  $\mathcal{M}/\mathcal{N}$  which can be regarded as a finite-dimensional matrix algebra with non-commuting  $\mathcal{N}$ -valued matrix elements. This suggests that full  $M$ -matrix can be expressed as  $M$ -matrix with  $\mathcal{N}$ -valued elements satisfying  $\mathcal{N}$ -unitarity conditions.

Physical intuition also suggests that the transition probabilities defined by quantum  $S$ -matrix must be commuting hermitian  $\mathcal{N}$ -valued operators inside every row and column. The traces of these operators give  $\mathcal{N}$ -averaged transition probabilities. The eigenvalue spectrum of these Hermitian matrices gives more detailed information about details below experimental resolution.  $\mathcal{N}$ -hermicity and commutativity pose powerful additional restrictions on the  $M$ -matrix.

Quantum  $M$ -matrix defines  $\mathcal{N}$ -valued entanglement coefficients between quantum states with  $\mathcal{N}$ -valued coefficients. How this affects the situation? The non-commutativity of quantum spinors has a natural interpretation in terms of fuzzy state function reduction meaning that quantum spinor corresponds effectively to a statistical ensemble which cannot correspond to pure state. Does this mean that predictions for transition probabilities must be averaged over the ensemble defined by "quantum quantum states"?

**Quantum fluctuations and inclusions**

Inclusions  $\mathcal{N} \subset \mathcal{M}$  of factors provide also a first principle description of quantum fluctuations since quantum fluctuations are by definition quantum dynamics below the measurement resolution. This gives hopes for articulating precisely what the important phrase "long range quantum fluctuations around quantum criticality" really means mathematically.

1. Phase transitions involve a change of symmetry. One might hope that the change of the symmetry group  $G_a \times G_b$  could universally code this aspect of phase transitions. This need not always mean a change of Planck constant but it means always a leakage between sectors of imbedding space. At quantum criticality 3-surfaces would have regions belonging to at least two sectors of  $H$ .
2. The long range of quantum fluctuations would naturally relate to a partial or total leakage of the 3-surface to a sector of imbedding space with larger Planck constant meaning zooming up of various quantal lengths.
3. For  $M$ -matrix in  $\mathcal{M}/\mathcal{N}$  regarded as  $calN$  module quantum criticality would mean a special kind of eigen state for the transition probability operator defined by the  $M$ -matrix. The properties of the number theoretic braids contributing to the  $M$ -matrix should characterize this state. The strands of the critical braids would correspond to fixed points for  $G_a \times G_b$  or its subgroup.

### **$M$ -matrix in finite measurement resolution**

The following arguments relying on the proposed identification of the space of zero energy states give a precise formulation for  $M$ -matrix in finite measurement resolution and the Connes tensor product involved. The original expectation that Connes tensor product could lead to a unique  $M$ -matrix is wrong. The replacement of  $\omega$  with its complex square root could lead to a unique hierarchy of  $M$ -matrices with finite measurement resolution and allow completely finite theory despite the fact that projectors have infinite trace for HFFs of type  $III_1$ .

1. In zero energy ontology the counterpart of Hermitian conjugation for operator is replaced with  $\mathcal{M} \rightarrow J\mathcal{M}J$  permuting the factors. Therefore  $N \in \mathcal{N}$  acting to positive (negative) energy part of state corresponds to  $N \rightarrow N' = JNJ$  acting on negative (positive) energy part of the state.
2. The allowed elements of  $N$  must be such that zero energy state remains zero energy state. The superposition of zero energy states involved can however change. Hence one must have that the counterparts of complex numbers are of form  $N = JN_1J \vee N_2$ , where  $N_1$  and  $N_2$  have same quantum numbers. A superposition of terms of this kind with varying quantum numbers for positive energy part of the state is possible.
3. The condition that  $N_{1i}$  and  $N_{2i}$  act like complex numbers in  $\mathcal{N}$ -trace means that the effect of  $JN_{1i}J \vee N_{2i}$  and  $JN_{2i}J \vee N_{1i}$  to the trace are identical and correspond to a multiplication by a constant. If  $\mathcal{N}$  is HFF of type  $II_1$  this follows from the decomposition  $\mathcal{M} = \mathcal{M}/\mathcal{N} \otimes \mathcal{N}$  and from  $Tr(AB) = Tr(BA)$  assuming that  $M$  is of form  $M = M_{\mathcal{M}/\mathcal{N}} \times P_{\mathcal{N}}$ . Contrary to the original hopes that Connes tensor product could fix the  $M$ -matrix there are no conditions on  $M_{\mathcal{M}/\mathcal{N}}$  which would give rise to a finite-dimensional  $M$ -matrix for Jones inclusions. One can replace the projector  $P_{\mathcal{N}}$  with a more general state if one takes this into account in  $*$  operation.
4. In the case of HFFs of type  $III_1$  the trace is infinite so that the replacement of  $Tr_N$  with a state  $\omega_N$  in the sense of factors looks more natural. This means that the counterpart of  $*$  operation exchanging  $N_1$  and  $N_2$  represented as  $SA\Omega = A^*\Omega$  involves  $\Delta$  via  $S = J\Delta^{1/2}$ . The exchange of  $N_1$  and  $N_2$  gives altogether  $\Delta$ . In this case the KMS condition  $\omega_N(AB) = \omega_N(\Delta A)$  guarantees the effective complex number property [?].
5. Quantum TGD more or less requires the replacement of  $\omega$  with its "complex square root" so that also a unitary matrix  $U$  multiplying  $\Delta$  is expected to appear in the formula for  $S$  and guarantee the symmetry. One could speak of a square root of KMS condition [?] in this case. The QFT counterpart would be a cutoff involving path integral over the degrees of freedom below the measurement resolution. In TGD framework it would mean a cutoff in the functional integral over WCW and for the modes of the second quantized induced spinor fields and also cutoff in sizes of causal diamonds. Discretization in terms of braids replacing light-like 3-surfaces should be the counterpart for the cutoff.
6. If one has  $M$ -matrix in  $\mathcal{M}$  expressible as a sum of  $M$ -matrices of form  $M_{\mathcal{M}/\mathcal{N}} \times M_{\mathcal{N}}$  with coefficients which correspond to the square roots of probabilities defining density matrix the tracing operation gives rise to square root of density matrix in  $M$ .

### Is universal M-matrix possible?

The realization of the finite measurement resolution could apply only to transition probabilities in which  $\mathcal{N}$ -trace or its generalization in terms of state  $\omega_{\mathcal{N}}$  is needed. One might however dream of something more.

1. Maybe there exists a universal M-matrix in the sense that the same M-matrix gives the M-matrices in finite measurement resolution for all inclusions  $\mathcal{N} \subset \mathcal{M}$ . This would mean that one can write

$$M = M_{\mathcal{M}/\mathcal{N}} \otimes M_{\mathcal{N}} \quad (13.7.8)$$

for any physically reasonable choice of  $\mathcal{N}$ . This would formally express the idea that  $M$  is as near as possible to M-matrix of free theory. Also fractality suggests itself in the sense that  $M_{\mathcal{N}}$  is essentially the same as  $M_{\mathcal{M}}$  in the same sense as  $\mathcal{N}$  is same as  $\mathcal{M}$ . It might be that the trivial solution  $M = 1$  is the only possible solution to the condition.

2.  $M_{\mathcal{M}/\mathcal{N}}$  would be obtained by the analog of  $Tr_{\mathcal{N}}$  or  $\omega_{\mathcal{N}}$  operation involving the "complex square root" of the state  $\omega$  in case of HFFs of type III<sub>1</sub>. The QFT counterpart would be path integration over the degrees of freedom below cutoff to get effective action.
3. Universality probably requires assumptions about the thermodynamical part of the universal M-matrix. A possible alternative form of the condition is that it holds true only for canonical choice of "complex square root" of  $\omega$  or for the S-matrix part of  $M$ :

$$S = S_{\mathcal{M}/\mathcal{N}} \otimes S_{\mathcal{N}} \quad (13.7.9)$$

for any physically reasonable choice  $\mathcal{N}$ .

4. In TGD framework the condition would say that the M-matrix defined by the modified Dirac action gives M-matrices in finite measurement resolution via the counterpart of integration over the degrees of freedom below the measurement resolution.

An objection against the universality is that if the M-matrix is "complex square root of state" cannot be unique and there are infinitely many choices related by a unitary transformation induced by the flows representing modular automorphism giving rise to new choices. This would actually be a well-come result and make possible quantum measurement theory. In the section "Handful of problems with a common resolution" of [K17] it was found that one must add to the modified Dirac action a measurement interaction term characterizing the measured observables. This implies stringy propagation as well as space-time correlates for quantum numbers characterizing the partonic states. These different modified Dirac actions would give rise to different Kähler functions. The corresponding Kähler metrics would not however differ if the real parts of the Kähler functions associated with the two choices differ by a term  $f(Z) + \bar{f}(Z)$ , where  $Z$  denotes complex coordinates of WCW, the Kähler metric remains the same. The function  $f$  can depend also on zero modes. If this is the case then one can allow in given CD superpositions of WCW spinor fields for which the measurement interactions are different.

### Connes tensor product and space-like entanglement

Ordinary linear Connes tensor product makes sense also in positive/negative energy sector and also now it makes sense to speak about measurement resolution. Hence one can ask whether Connes tensor product should be posed as a constraint on space-like entanglement. The interpretation could be in terms of the formation of bound states. The reducibility of HFFs and inclusions means that the tensor product is not uniquely fixed and ordinary entanglement could correspond to this kind of entanglement.

Also the counterpart of p-adic coupling constant evolution would makes sense. The interpretation of Connes tensor product would be as the variance of the states with respect to some subgroup of  $U(n)$  associated with the measurement resolution: the analog of color confinement would be in question.

## 2-vector spaces and entanglement modulo measurement resolution

John Baez and collaborators [?] are playing with very formal looking formal structures obtained by replacing vectors with vector spaces. Direct sum and tensor product serve as the basic arithmetic operations for the vector spaces and one can define category of  $n$ -tuples of vector spaces with morphisms defined by linear maps between vectors spaces of the tuple.  $n$ -tuples allow also element-wise product and sum. They obtain results which make them happy. For instance, the category of linear representations of a given group forms 2-vector spaces since direct sums and tensor products of representations as well as  $n$ -tuples make sense. The 2-vector space however looks more or less trivial from the point of physics.

The situation could become more interesting in quantum measurement theory with finite measurement resolution described in terms of inclusions of hyper-finite factors of type  $\text{II}_1$ . The reason is that Connes tensor product replaces ordinary tensor product and brings in interactions via irreducible entanglement as a representation of finite measurement resolution. The category in question could give Connes tensor products of quantum state spaces and describing interactions. For instance, one could multiply  $M$ -matrices via Connes tensor product to obtain category of  $M$ -matrices having also the structure of 2-operator algebra.

1. The included algebra represents measurement resolution and this means that the infinite-D sub-Hilbert spaces obtained by the action of this algebra replace the rays. Sub-factor takes the role of complex numbers in generalized QM so that one obtains non-commutative quantum mechanics. For instance, quantum entanglement for two systems of this kind would not be between rays but between infinite-D subspaces corresponding to sub-factors. One could build a generalization of QM by replacing rays with sub-spaces and it would seem that quantum group concept does more or less this: the states in representations of quantum groups could be seen as infinite-dimensional Hilbert spaces.
2. One could speak about both operator algebras and corresponding state spaces modulo finite measurement resolution as quantum operator algebras and quantum state spaces with fractal dimension defined as factor space like entities obtained from HFF by dividing with the action of included HFF. Possible values of the fractal dimension are fixed completely for Jones inclusions. Maybe these quantum state spaces could define the notions of quantum 2-Hilbert space and 2-operator algebra via direct sum and tensor production operations. Fractal dimensions would make the situation interesting both mathematically and physically.

Suppose one takes the fractal factor spaces as the basic structures and keeps the information about inclusion.

1. Direct sums for quantum vectors spaces would be just ordinary direct sums with HFF containing included algebras replaced with direct sum of included HFFs.
2. The tensor products for quantum state spaces and quantum operator algebras are not anymore trivial. The condition that measurement algebras act effectively like complex numbers would require Connes tensor product involving irreducible entanglement between elements belonging to the two HFFs. This would have direct physical relevance since this entanglement cannot be reduced in state function reduction. The category would defined interactions in terms of Connes tensor product and finite measurement resolution.
3. The sequences of super-conformal symmetry breakings identifiable in terms of inclusions of super-conformal algebras and corresponding HFFs could have a natural description using the 2-Hilbert spaces and quantum 2-operator algebras.

### 13.7.7 Questions about quantum measurement theory in zero energy ontology

In the following some questions about quantum measurement theory are posed. First however a result about the relationship between  $U$ -matrix and  $M$ -matrix not known when the questions were made will be represented. The background allowing a deeper understanding of this result can be found from [K42] discussing Negentropy Maximization Principle, which is the basic dynamical principle of



TGD inspired theory of consciousness and states that the information content of conscious experience is maximal.

### The relationship between $U$ -matrix and $M$ -matrix

Before proceeding it is a good idea to clarify the relationship between the notions of  $U$ -matrix and  $M$ -matrix. If state function reduction associated with time-like entanglement leads always to a product of positive and negative energy states (so that there is no counterpart of bound state entanglement and negentropic entanglement possible for zero energy states: these notions are discussed below)  $U$ -matrix and can be regarded as a collection of  $M$ -matrices

$$U_{m_+n_-,r_+,s_-} = M(m_+,n_-)_{r_+,s_-} \quad (13.7.10)$$

labeled by the pairs  $(m_+,n_-)$  labelling zero energy states assumed to reduced to pairs of positive and negative energy states.  $M$ -matrix element is the counterpart of S-matrix element  $S_{r,s}$  in positive energy ontology. Unitarity conditions for  $U$ -matrix read as

$$\begin{aligned} (UU^\dagger)_{m_+n_-,r_+,s_-} &= \sum_{k_+,l_-} M(m_+,n_-)_{k_+,l_-} \overline{M}(r_+,s_-)_{k_+,l_-} = \delta_{m_+r_+,n_-s_-} \quad , \\ (U^\dagger U)_{m_+n_-,r_+,s_-} &= \sum_{k_+,l_-} \overline{M}(k_+,l_-)_{m_+,n_-} M(k_+,l_-)_{r_+,s_-} = \delta_{m_+r_+,n_-s_-} \quad . \end{aligned} \quad (13.7.11)$$

The conditions state that the zero energy states associated with different labels are orthogonal as zero energy states and also that the zero energy states defined by the dual  $M$ -matrix

$$M^\dagger(m_+,n_-)_{k_+,l_-} \equiv \overline{M}(k_+,l_-)_{m_+,n_-} \quad (13.7.12)$$

-perhaps identifiable as phase conjugate states- define an orthonormal basis of zero energy states.

When time-like binding and negentropic entanglement are allowed also zero energy states with a label not implying a decomposition to a product state are involved with the unitarity condition but this does not affect the situation dramatically. As a matter fact, the situation is mathematically the same as for ordinary S-matrix in the presence of bound states. Here time-like bound states are analogous to space-like bound states and by definition are unable to decay to product states (free states). Negentropic entanglement makes sense only for entanglement probabilities, which are rationals or belong to their algebraic extensions. This is possible in what might be called the intersection of real and p-adic worlds (partonic surfaces in question have representation making sense for both real and p-adic numbers). Number theoretic entropy is obtained by replacing in the Shannon entropy the logarithms of probabilities with the logarithms of their p-adic norms. They satisfy the same defining conditions as ordinary Shannon entropy but can be also negative. One can always find prime  $p$  for which the entropy is maximally negative. The interpretation of negentropic entanglement is in terms of formations of rule or association. Schrödinger cat knows that it is better to not open the bottle: open bottle-dead cat, closed bottle-living cat and negentropic entanglement measures this information.

### Fractal hierarchy of state function reductions

In accordance with fractality, the conditions for the Connes tensor product at a given time scale imply the conditions at shorter time scales. On the other hand, in shorter time scales the inclusion would be deeper and would give rise to a larger reducibility of the representation of  $\mathcal{N}$  in  $\mathcal{M}$ . Formally, as  $\mathcal{N}$  approaches to a trivial algebra, one would have a square root of density matrix and trivial  $S$ -matrix in accordance with the idea about asymptotic freedom.

$M$ -matrix would give rise to a matrix of probabilities via the expression  $P(P_+ \rightarrow P_-) = Tr[P_+ M^\dagger P_- M]$ , where  $P_+$  and  $P_-$  are projectors to positive and negative energy energy  $\mathcal{N}$ -rays. The projectors give rise to the averaging over the initial and final states inside  $\mathcal{N}$  ray. The reduction could continue step by step to shorter length scales so that one would obtain a sequence of inclusions. If the  $U$ -process of

the next quantum jump can return the  $M$ -matrix associated with  $\mathcal{M}$  or some larger HFF, U process would be kind of reversal for state function reduction.

Analytic thinking proceeding from vision to details; human life cycle proceeding from dreams and wild actions to the age when most decisions relate to the routine daily activities; the progress of science from macroscopic to microscopic scales; even biological decay processes: all these have an intriguing resemblance to the fractal state function reduction proceeding to shorter and shorter time scales. Since this means increasing thermality of  $M$ -matrix, U process as a reversal of state function reduction might break the second law of thermodynamics.

The conservative option would be that only the transformation of intentions to action by U process giving rise to new zero energy states can bring in something new and is responsible for evolution. The non-conservative option is that the biological death is the  $U$ -process of the next quantum jump leading to a new life cycle. Breathing would become a universal metaphor for what happens in quantum Universe. The 4-D body would be lived again and again.

### How quantum classical correspondence is realized at parton level?

Quantum classical correspondence must assign to a given quantum state the most probable space-time sheet depending on its quantum numbers. The space-time sheet  $X^4(X^3)$  defined by the Kähler function depends however only on the partonic 3-surface  $X^3$ , and one must be able to assign to a given quantum state the most probable  $X^3$  - call it  $X^3_{max}$  - depending on its quantum numbers.

$X^4(X^3_{max})$  should carry the gauge fields created by classical gauge charges associated with the Cartan algebra of the gauge group (color isospin and hypercharge and electromagnetic and  $Z^0$  charge) as well as classical gravitational fields created by the partons. This picture is very similar to that of quantum field theories relying on path integral except that the path integral is restricted to 3-surfaces  $X^3$  with exponent of Kähler function bringing in genuine convergence and that 4-D dynamics is deterministic apart from the delicacies due to the 4-D spin glass type vacuum degeneracy of Kähler action.

Stationary phase approximation selects  $X^3_{max}$  if the quantum state contains a phase factor depending not only on  $X^3$  but also on the quantum numbers of the state. A good guess is that the needed phase factor corresponds to either Chern-Simons type action or an action describing the interaction of the induced gauge field with the charges associated with the braid strand. This action would be defined for the induced gauge fields. YM action seems to be excluded since it is singular for light-like 3-surfaces associated with the light-like wormhole throats (not only  $\sqrt{\det(g_3)}$  but also  $\sqrt{\det(g_4)}$  vanishes).

The challenge is to show that this is enough to guarantee that  $X^4(X^3_{max})$  carries correct gauge charges. Kind of electric-magnetic duality should relate the normal components  $F_{ni}$  of the gauge fields in  $X^4(X^3_{max})$  to the gauge fields  $F_{ij}$  induced at  $X^3$ . An alternative interpretation is in terms of quantum gravitational holography. The difference between Chern-Simons action characterizing quantum state and the fundamental Chern-Simons type factor associated with the Kähler form would be that the latter emerges as the phase of the Dirac determinant.

One is forced to introduce gauge couplings and also electro-weak symmetry breaking via the phase factor. This is in apparent conflict with the idea that all couplings are predictable. The essential uniqueness of  $M$ -matrix in the case of HFFs of type  $II_1$  (at least) however means that their values as a function of measurement resolution time scale are fixed by internal consistency. Also quantum criticality leads to the same conclusion. Obviously a kind of bootstrap approach suggests itself.

### 13.7.8 How p-adic coupling constant evolution and p-adic length scale hypothesis emerge from quantum TGD proper?

What p-adic coupling constant evolution really means has remained for a long time more or less open. The progress made in the understanding of the S-matrix of theory has however changed the situation dramatically.

#### M-matrix and coupling constant evolution

The final breakthrough in the understanding of p-adic coupling constant evolution came through the understanding of S-matrix, or actually M-matrix defining entanglement coefficients between positive

and negative energy parts of zero energy states in zero energy ontology [K17]. M-matrix has interpretation as a "complex square root" of density matrix and thus provides a unification of thermodynamics and quantum theory. S-matrix is analogous to the phase of Schrödinger amplitude multiplying positive and real square root of density matrix analogous to modulus of Schrödinger amplitude.

The notion of finite measurement resolution realized in terms of inclusions of von Neumann algebras allows to demonstrate that the irreducible components of M-matrix are unique and possesses huge symmetries in the sense that the hermitian elements of included factor  $\mathcal{N} \subset \mathcal{M}$  defining the measurement resolution act as symmetries of M-matrix, which suggests a connection with integrable quantum field theories.

It is also possible to understand coupling constant evolution as a discretized evolution associated with time scales  $T_n$ , which come as octaves of a fundamental time scale:  $T_n = 2^n T_0$ . Number theoretic universality requires that renormalized coupling constants are rational or at most algebraic numbers and this is achieved by this discretization since the logarithms of discretized mass scale appearing in the expressions of renormalized coupling constants reduce to the form  $\log(2^n) = n \log(2)$  and with a proper choice of the coefficient of logarithm  $\log(2)$  dependence disappears so that rational number results. Recall that also the weaker condition  $T_p = p T_0$ ,  $p$  prime, would assign secondary p-adic time scales to the size scale hierarchy of *CDs*:  $p \simeq 2^n$  would result as an outcome of some kind of "natural selection" for this option. The highly satisfactory feature would be that p-adic time scales would reflect directly the geometry of imbedding space and configuration space.

### p-Adic coupling constant evolution

An attractive conjecture is that the coupling constant evolution associated with *CDs* in powers of 2 implying time scale hierarchy  $T_n = 2^n T_0$  induces p-adic coupling constant evolution and explain why p-adic length scales correspond to  $L_p \propto \sqrt{p} R$ ,  $p \simeq 2^k$ ,  $R$   $CP_2$  length scale? This looks attractive but there seems to be a problem. p-Adic length scales come as powers of  $\sqrt{2}$  rather than 2 and the strongly favored values of  $k$  are primes and thus odd so that  $n = k/2$  would be half odd integer. This problem can be solved.

1. The observation that the distance traveled by a Brownian particle during time  $t$  satisfies  $r^2 = Dt$  suggests a solution to the problem. p-Adic thermodynamics applies because the partonic 3-surfaces  $X^2$  are as 2-D dynamical systems random apart from light-likeness of their orbit. For  $CP_2$  type vacuum extremals the situation reduces to that for a one-dimensional random light-like curve in  $M^4$ . The orbits of Brownian particle would now correspond to light-like geodesics  $\gamma_3$  at  $X^3$ . The projection of  $\gamma_3$  to a time=constant section  $X^2 \subset X^3$  would define the 2-D path  $\gamma_2$  of the Brownian particle. The  $M^4$  distance  $r$  between the end points of  $\gamma_2$  would be given  $r^2 = Dt$ . The favored values of  $t$  would correspond to  $T_n = 2^n T_0$  (the full light-like geodesic). p-Adic length scales would result as  $L^2(k) = DT(k) = D2^k T_0$  for  $D = R^2/T_0$ . Since only  $CP_2$  scale is available as a fundamental scale, one would have  $T_0 = R$  and  $D = R$  and  $L^2(k) = T(k)R$ .
2. p-Adic primes near powers of 2 would be in preferred position. p-Adic time scale would not relate to the p-adic length scale via  $T_p = L_p/c$  as assumed implicitly earlier but via  $T_p = L_p^2/R_0 = \sqrt{p} L_p$ , which corresponds to secondary p-adic length scale. For instance, in the case of electron with  $p = M_{127}$  one would have  $T_{127} = .1$  second which defines a fundamental biological rhythm. Neutrinos with mass around .1 eV would correspond to  $L(169) \simeq 5 \mu\text{m}$  (size of a small cell) and  $T(169) \simeq 1. \times 10^4$  years. A deep connection between elementary particle physics and biology becomes highly suggestive.
3. In the proposed picture the p-adic prime  $p \simeq 2^k$  would characterize the thermodynamics of the random motion of light-like geodesics of  $X^3$  so that p-adic prime  $p$  would indeed be an inherent property of  $X^3$ . For the weaker condition would be  $T_p = p T_0$ ,  $p$  prime,  $p \simeq 2^n$  could be seen as an outcome of some kind of "natural selection". In this case,  $p$  would a property of *CD* and all light-like 3-surfaces inside it and also that corresponding sector of configuration space.
4. The fundamental role of 2-adicity suggests that the fundamental coupling constant evolution and p-adic mass calculations could be formulated also in terms of 2-adic thermodynamics. With a suitable definition of the canonical identification used to map 2-adic mass squared values to real numbers this is possible, and the differences between 2-adic and p-adic thermodynamics

are extremely small for large values of for  $p \simeq 2^k$ . 2-adic temperature must be chosen to be  $T_2 = 1/k$  whereas p-adic temperature is  $T_p = 1$  for fermions. If the canonical identification is defined as

$$\sum_{n \geq 0} b_n 2^n \rightarrow \sum_{m \geq 1} 2^{-m+1} \sum_{(k-1)m \leq n < km} b_n 2^n ,$$

it maps all 2-adic integers  $n < 2^k$  to themselves and the predictions are essentially same as for p-adic thermodynamics. For large values of  $p \simeq 2^k$  2-adic real thermodynamics with  $T_R = 1/k$  gives essentially the same results as the 2-adic one in the lowest order so that the interpretation in terms of effective 2-adic/p-adic topology is possible.

### 13.7.9 Planar algebras and generalized Feynman diagrams

Planar algebras [?] are a very general notion due to Vaughan Jones and a special class of them is known to characterize inclusion sequences of hyper-finite factors of type  $II_1$  [?]. In the following an argument is developed that planar algebras might have interpretation in terms of planar projections of generalized Feynman diagrams (these structures are metrically 2-D by presence of one light-like direction so that 2-D representation is especially natural). In [?] the role of planar algebras and their generalizations is also discussed.

#### Planar algebra very briefly

First a brief definition of planar algebra.

1. One starts from planar  $k$ -tangles obtained by putting disks inside a big disk. Inner disks are empty. Big disk contains  $2k$  braid strands starting from its boundary and returning back or ending to the boundaries of small empty disks in the interior containing also even number of incoming lines. It is possible to have also loops. Disk boundaries and braid strands connecting them are different objects. A black-white coloring of the disjoint regions of  $k$ -tangle is assumed and there are two possible options (photo and its negative). Equivalence of planar tangles under diffeomorphisms is assumed.
2. One can define a product of  $k$ -tangles by identifying  $k$ -tangle along its outer boundary with some inner disk of another  $k$ -tangle. Obviously the product is not unique when the number of inner disks is larger than one. In the product one deletes the inner disk boundary but if one interprets this disk as a vertex-parton, it would be better to keep the boundary.
3. One assigns to the planar  $k$ -tangle a vector space  $V_k$  and a linear map from the tensor product of spaces  $V_{k_i}$  associated with the inner disks such that this map is consistent with the decomposition  $k$ -tangles. Under certain additional conditions the resulting algebra gives rise to an algebra characterizing multi-step inclusion of HFFs of type  $II_1$ .
4. It is possible to bring in additional structure and in TGD framework it seems necessary to assign to each line of tangle an arrow telling whether it corresponds to a strand of a braid associated with positive or negative energy parton. One can also wonder whether disks could be replaced with closed 2-D surfaces characterized by genus if braids are defined on partonic surfaces of genus  $g$ . In this case there is no topological distinction between big disk and small disks. One can also ask why not allow the strands to get linked (as suggested by the interpretation as planar projections of generalized Feynman diagrams) in which case one would not have a planar tangle anymore.

#### General arguments favoring the assignment of a planar algebra to a generalized Feynman diagram

There are some general arguments in favor of the assignment of planar algebra to generalized Feynman diagrams.

1. Planar diagrams describe sequences of inclusions of HFF:s and assign to them a multi-parameter algebra corresponding indices of inclusions. They describe also Connes tensor powers in the simplest situation corresponding to Jones inclusion sequence. Suppose that also general Connes tensor product has a description in terms of planar diagrams. This might be trivial.
2. Generalized vertices identified geometrically as partonic 2-surfaces indeed contain Connes tensor products. The smallest sub-factor  $N$  would play the role of complex numbers meaning that due to a finite measurement resolution one can speak only about  $N$ -rays of state space and the situation becomes effectively finite-dimensional but non-commutative.
3. The product of planar diagrams could be seen as a projection of 3-D Feynman diagram to plane or to one of the partonic vertices. It would contain a set of 2-D partonic 2-surfaces. Some of them would correspond vertices and the rest to partonic 2-surfaces at future and past directed light-cones corresponding to the incoming and outgoing particles.
4. The question is how to distinguish between vertex-partons and incoming and outgoing partons. If one does not delete the disk boundary of inner disk in the product, the fact that lines arrive at it from both sides could distinguish it as a vertex-parton whereas outgoing partons would correspond to empty disks. The direction of the arrows associated with the lines of planar diagram would allow to distinguish between positive and negative energy partons (note however line returning back).
5. One could worry about preferred role of the big disk identifiable as incoming or outgoing parton but this role is only apparent since by compactifying to say  $S^2$  the big disk exterior becomes an interior of a small disk.

#### A more detailed view

The basic fact about planar algebras is that in the product of planar diagrams one glues two disks with identical boundary data together. One should understand the counterpart of this in more detail.

1. The boundaries of disks would correspond to 1-D closed space-like stringy curves at partonic 2-surfaces along which fermionic anti-commutators vanish.
2. The lines connecting the boundaries of disks to each other would correspond to the strands of number theoretic braids and thus to braided time evolutions. The intersection points of lines with disk boundaries would correspond to the intersection points of strands of number theoretic braids meeting at the generalized vertex.  
[Number theoretic braid belongs to an algebraic intersection of a real parton 3-surface and its  $p$ -adic counterpart obeying same algebraic equations: of course, in time direction algebraicity allows only a sequence of snapshots about braid evolution].
3. Planar diagrams contain lines, which begin and return to the same disk boundary. Also "vacuum bubbles" are possible. Braid strands would disappear or appear in pairwise manner since they correspond to zeros of a polynomial and can transform from complex to real and vice versa under rather stringent algebraic conditions.
4. Planar diagrams contain also lines connecting any pair of disk boundaries. Stringy decay of partonic 2-surfaces with some strands of braid taken by the first and some strands by the second parton might bring in the lines connecting boundaries of any given pair of disks (if really possible!).
5. There is also something to worry about. The number of lines associated with disks is even in the case of  $k$ -tangles. In TGD framework incoming and outgoing tangles could have odd number of strands whereas partonic vertices would contain even number of  $k$ -tangles from fermion number conservation. One can wonder whether the replacement of boson lines with fermion lines could imply naturally the notion of half- $k$ -tangle or whether one could assign half- $k$ -tangles to the spinors of the configuration space ("world of classical worlds") whereas corresponding Clifford algebra defining HFF of type  $II_1$  would correspond to  $k$ -tangles.

### 13.7.10 Miscellaneous

The following considerations are somewhat out-of-date: hence the title 'Miscellaneous'.

#### Connes tensor product and fusion rules

One should demonstrate that Connes tensor product indeed produces an  $M$ -matrix with physically acceptable properties.

The reduction of the construction of vertices to that for  $n$ -point functions of a conformal field theory suggest that Connes tensor product is essentially equivalent with the fusion rules for conformal fields defined by the Clifford algebra elements of  $CH(CD)$  (4-surfaces associated with 3-surfaces at the boundary of causal diamond  $CD$  in  $M^4$ ), extended to local fields in  $M^4$  with gamma matrices acting on configuration space spinors assignable to the partonic boundary components.

Jones speculates that the fusion rules of conformal field theories can be understood in terms of Connes tensor product [?] and refers to the work of Wassermann about the fusion of loop group representations as a demonstration of the possibility to formula the fusion rules in terms of Connes tensor product [?] .

Fusion rules are indeed something more intricate than the naive product of free fields expanded using oscillator operators. By its very definition Connes tensor product means a dramatic reduction of degrees of freedom and this indeed happens also in conformal field theories.

1. For non-vanishing  $n$ -point functions the tensor product of representations of Kac Moody group associated with the conformal fields must give singlet representation.
2. The ordinary tensor product of Kac Moody representations characterized by given value of central extension parameter  $k$  is not possible since  $k$  would be additive.
3. A much stronger restriction comes from the fact that the allowed representations must define integrable representations of Kac-Moody group [?] . For instance, in case of  $SU(2)_k$  Kac Moody algebra only spins  $j \leq k/2$  are allowed. In this case the quantum phase corresponds to  $n = k+2$ .  $SU(2)$  is indeed very natural in TGD framework since it corresponds to both electro-weak  $SU(2)_L$  and isotropy group of particle at rest.

Fusion rules for localized Clifford algebra elements representing operators creating physical states would replace naive tensor product with something more intricate. The naivest approach would start from  $M^4$  local variants of gamma matrices since gamma matrices generate the Clifford algebra  $Cl$  associated with  $CH(CD)$ . This is certainly too naive an approach. The next step would be the localization of more general products of Clifford algebra elements elements of Kac Moody algebras creating physical states and defining free on mass shell quantum fields. In standard quantum field theory the next step would be the introduction of purely local interaction vertices leading to divergence difficulties. In the recent case one transfers the partonic states assignable to the light-cone boundaries  $\delta M_{\pm}^4(m_i) \times CP_2$  to the common partonic 2-surfaces  $X_V^2$  along  $X_{L,i}^3$  so that the products of field operators at the same space-time point do not appear and one avoids infinities.

The remaining problem would be the construction an explicit realization of Connes tensor product. The formal definition states that left and right  $\mathcal{N}$  actions in the Connes tensor product  $\mathcal{M} \otimes_{\mathcal{N}} \mathcal{M}$  are identical so that the elements  $nm_1 \otimes m_2$  and  $m_1 \otimes m_2n$  are identified. This implies a reduction of degrees of freedom so that free tensor product is not in question. One might hope that at least in the simplest choices for  $\mathcal{N}$  characterizing the limitations of quantum measurement this reduction is equivalent with the reduction of degrees of freedom caused by the integrability constraints for Kac-Moody representations and dropping away of higher spins from the ordinary tensor product for the representations of quantum groups. If fusion rules are equivalent with Connes tensor product, each type of quantum measurement would be characterized by its own conformal field theory.

In practice it seems safest to utilize as much as possible the physical intuition provided by quantum field theories. In [K17] a rather precise vision about generalized Feynman diagrams is developed and the challenge is to relate this vision to Connes tensor product.

#### Connection with topological quantum field theories defined by Chern-Simons action

There is also connection with topological quantum field theories (TQFTs) defined by Chern- Simons action [?] .

1. The light-like 3-surfaces  $X_l^3$  defining propagators can contain unitary matrix characterizing the braiding of the lines connecting fermions at the ends of the propagator line. Therefore the modular  $S$ -matrix representing the braiding would become part of propagator line. Also incoming particle lines can contain similar  $S$ -matrices but they should not be visible in the  $M$ -matrix. Also entanglement between different partonic boundary components of a given incoming 3-surface by a modular  $S$ -matrix is possible.
2. Besides  $CP_2$  type extremals MEs with light-like momenta can appear as brehmstrahlung like exchanges always accompanied by exchanges of  $CP_2$  type extremals making possible momentum conservation. Also light-like boundaries of magnetic flux tubes having macroscopic size could carry light-like momenta and represent similar brehmstrahlung like exchanges. In this case the modular  $S$ -matrix could make possible topological quantum computations in  $q \neq 1$  phase [K81]. Notice the somewhat counter intuitive implication that magnetic flux tubes of macroscopic size would represent change in quantum jump rather than quantum state. These quantum jumps can have an arbitrary long geometric duration in macroscopic quantum phases with large Planck constant [K22].

There is also a connection with topological QFT defined by Chern-Simons action allowing to assign topological invariants to the 3-manifolds [?]. If the light-like CDs  $X_{L,i}^3$  are boundary components, the 3-surfaces associated with particles are glued together somewhat like they are glued in the process allowing to construct 3-manifold by gluing them together along boundaries. All 3-manifold topologies can be constructed by using only torus like boundary components.

This would suggest a connection with 2+1-dimensional topological quantum field theory defined by Chern-Simons action allowing to define invariants for knots, links, and braids and 3-manifolds using surgery along links in terms of Wilson lines. In these theories one consider gluing of two 3-manifolds, say three-spheres  $S^3$  along a link to obtain a topologically non-trivial 3-manifold. The replacement of link with Wilson lines in  $S^3 \# S^3 = S^3$  reduces the calculation of link invariants defined in this manner to Chern-Simons theory in  $S^3$ .

In the recent situation more general structures are possible since arbitrary number of 3-manifolds are glued together along link so that a singular 3-manifolds with a book like structure are possible. The allowance of CDs which are not boundaries, typically 3-D light-like throats of wormhole contacts at which induced metric transforms from Minkowskian to Euclidian, brings in additional richness of structure. If the scaling factor of  $CP_2$  metric can be arbitrary large as the quantization of Planck constant predicts, this kind of structure could be macroscopic and could be also linked and knotted. In fact, topological condensation could be seen as a process in which two 4-manifolds are glued together by drilling light-like CDs and connected by a piece of  $CP_2$  type extremal.

## 13.8 Fresh view about hyper-finite factors in TGD framework

In the following I will discuss the basic ideas about the role of hyper-finite factors in TGD with the background given by a work of more than half decade. First I summarize the input ideas which I combine with the TGD inspired intuitive wisdom about HFFs of type  $II_1$  and their inclusions allowing to represent finite measurement resolution and leading to notion of quantum spaces with algebraic number valued dimension defined by the index of the inclusion.

Also an argument suggesting that the inclusions define "skewed" inclusions of lattices to larger lattices giving rise to quasicrystals is proposed. The core of the argument is that the included HFF of type  $II_1$  algebra is a projection of the including algebra to a subspace with dimension  $D \leq 1$ . The projection operator defines the analog of a projection of a bigger lattice to the included lattice. Also the fact that the dimension of the tensor product is product of dimensions of factors just like the number of elements in finite group is product of numbers of elements of coset space and subgroup, supports this interpretation.

One also ends up with a detailed identification of the hyper-finite factors in orbital degrees of freedom in terms of symplectic group associated with  $\delta M_{\pm}^4 \times CP_2$  and the group algebras of their discrete subgroups define what could be called "orbital degrees of freedom" for WCW spinor fields. By very general argument this group algebra is HFF of type  $II$ , maybe even  $II_1$ .

### 13.8.1 Crystals, quasicrystals, non-commutativity and inclusions of hyper-finite factors of type $II_1$

I list first the basic ideas about non-commutative geometries and give simple argument suggesting that inclusions of HFFs correspond to "skewed" inclusions of lattices as quasicrystals.

1. Quasicrystals (say Penrose tilings) [?] can be regarded as subsets of real crystals and one can speak about "skewed" inclusion of real lattice to larger lattice as quasicrystal. What this means that included lattice is obtained by projecting the larger lattice to some lower-dimensional subspace of lattice.
2. The argument of Connes concerning definition of non-commutative geometry can be found in the book of Michel Lapidus at page 200. Quantum space is identified as a space of equivalence classes. One assigns to pairs of elements inside equivalence class matrix elements having the element pair as indices (one assumes numerable equivalence class). One considers irreducible representations of the algebra defined by the matrices and identifies the equivalent irreducible representations. If I have understood correctly, the equivalence classes of irreps define a discrete point set representing the equivalence class and it can often happen that there is just single point as one might expect. This I do not quite understand since it requires that all irreps are equivalent.
3. It seems that in the case of linear spaces - von Neumann algebras and accompanying Hilbert spaces - one obtains a connection with the inclusions of HFFs and corresponding quantum factor spaces that should exist as analogs of quantum plane. One replaces matrices with elements labelled by element pairs with linear operators in HFF of type  $II_1$ . Index pairs correspond to pairs in linear basis for the HFF or corresponding Hilbert space.
4. Discrete infinite enumerable basis for these operators as a linear space generates a lattice in summation. Inclusion  $N \subset M$  defines inclusion of the lattice/crystal for  $N$  to the corresponding lattice of  $M$ . Physical intuition suggests that if this inclusion is "skewed" one obtains quasicrystal. The fact the index of the inclusion is algebraic number suggests that the coset space  $M/N$  is indeed analogous to quasicrystal.

More precisely, the index of inclusion is defined for hyper-finite factors of type  $II_1$  using the fact that quantum trace of unit matrix equals to unity  $Tr(Id(M)) = 1$ , and from the tensor product composition  $M = (M/N) \times N$  given  $Tr(Id(M)) = 1 = Ind(M/N)Tr(P(M \rightarrow N))$ , where  $P(M \rightarrow N)$  is projection operator from  $M$  to  $N$ . Clearly,  $Ind(M/N) = 1/Tr(P(M \rightarrow N))$  defines index as a dimension of quantum space  $M/N$ .

For Jones inclusions characterized by quantum phases  $q = exp(i2\pi/n)$ ,  $n = 3, 4, \dots$  the values of index are given by  $Ind(M/N) = 4cos^2(\pi/n)$ ,  $n = 3, 4, \dots$ . There is also another range inclusions  $Ind(M/N) \geq 4$ : note that  $Tr(P(M \rightarrow N))$  defining the dimension of  $N$  as included sub-space is never larger than one for HFFs of type  $II_1$ . The projection operator  $P(M \rightarrow N)$  is obviously the counterpart of the projector projecting lattice to some lower-dimensional sub-space of the lattice.

5. Jones inclusions are between linear spaces but there is a strong analogy with non-linear coset spaces since for the tensor product the dimension is product of dimensions and for discrete coset spaces  $G/H$  one has also the product formula  $n(G) = n(H) \times n(G/H)$  for the numbers of elements. Noticing that space of quantum amplitudes in discrete space has dimension equal to the number of elements of the space, one could say that Jones inclusion represents quantized variant for classical inclusion raised from the level of discrete space to the level of space of quantum states with the number of elements of set replaced by dimension. In fact, group algebras of infinite and enumerable groups defined HFFs of type  $II$  under rather general conditions (see below).

Could one generalize Jones inclusions so that they would apply to non-linear coset spaces analogs of the linear spaces involved? For instance, could one think of infinite-dimensional groups  $G$  and  $H$  for which Lie-algebras defining their tangent spaces can be regarded as HFFs of type  $II_1$ ? The dimension of the tangent space is dimension of the non-linear manifold: could this mean that the non-linear infinite-dimensional inclusions reduce to tangent space level and thus



to the inclusions for Lie-algebras regarded hyper-finite factors of type  $II_1$  or more generally, type  $II$ ? This would rise to quantum spaces which have finite but algebraic valued quantum dimension and in TGD framework take into account the finite measurement resolution.

6. To concretize this analogy one can check what is the number of points map from 5-D space containing aperiodic lattice as a projection to a 2-D irrational plane containing only origin as common point with the 5-D lattice. It is easy to get convinced that the projection is 1-to-1 so that the number of points projected to a given point is 1. By the analogy with Jones inclusions this would mean that the included space has same von Neumann dimension 1 - just like the including one. In this case quantum phase equals  $q = \exp(i2\pi/n)$ ,  $n = 3$  - the lowest possible value of  $n$ . Could one imagine the analogs of  $n > 3$  inclusions for which the number of points projected to a given point would be larger than 1? In 1-D case the rational lines  $y = (k/l)x$  define 1-D rational analogs of quasi crystals. The points  $(x, y) = (m, n)$ ,  $m \bmod l = 0$  are projected to the same point. The number of points is now infinite and the ratio of points of 2-D lattice and 1-D crystal like structure equals to  $l$  and serves as the analog for the quantum dimension  $d_q = 4\cos^2(\pi/n)$ .

To sum up, this is just physicist's intuition: it could be wrong or something totally trivial from the point of view of mathematician. The main message is that the inclusions of HFFs might define also inclusions of lattices as quasicrystals.

### 13.8.2 HFFs and their inclusions in TGD framework

In TGD framework the inclusions of HFFs have interpretation in terms of finite measurement resolution. If the inclusions define quasicrystals then finite measurement resolution would lead to quasicrystals.

1. The automorphic action of  $N$  in  $M \supset N$  and in associated Hilbert space  $H_M$  where  $N$  acts generates physical operators and accompanying states (operator rays and rays) not distinguishable from the original one. States in finite measurement resolution correspond to  $N$ -rays rather than complex rays. It might be natural to restrict to unitary elements of  $N$ .

This leads to the need to construct the counterpart of coset space  $M/N$  and corresponding linear space  $H_M/H_N$ . Physical intuition tells that the indices of inclusions defining the "dimension" of  $M/N$  are algebraic numbers given by Jones index formula.

2. Here the above argument would assign to the inclusions also inclusions of lattices as quasicrystals.

### Degrees of freedom for WCW spinor field

Consider first the identification of various kinds of degrees of freedom in TGD Universe.

1. Very roughly, WCW ("world of classical worlds") spinor is a state generated by fermionic creation operators from vacuum at given 3-surface. WCW spinor field assigns this kind of spinor to each 3-surface. WCW spinor fields decompose to tensor product of spin part (Fock state) and orbital part ("wave" in WCW) just as ordinary spinor fields.
2. The conjecture motivated by super-symmetry has been that both WCW spinors and their orbital parts (analogs of scalar field) define HFFs of type  $II_1$  in quantum fluctuating degrees of freedom.
3. Besides these there are zero modes, which by definition do not contribute to WCW Kähler metric.
  - (a) If the zero modes are symplectic invariants, they appear only in conformal factor of WCW metric. Symplectically invariant zero modes represent purely classical degrees of freedom - direction of a pointer of measurement apparatus in quantum measurement - and in given experimental arrangement they entangle with quantum fluctuating degrees of freedom in one-to-one manner so that state function reduction assigns to the outcome of state function reduction position of pointer. I forget symplectically invariant zero modes and other analogous variables in the following and concentrate to the degrees of freedom contributing WCW line-element.

- (b) There are also zero modes which are not symplectic invariants and are analogous to degrees of freedom generated by the generators of Kac-Moody algebra having vanishing conformal weight. They represent "center of mass degrees of freedom" and this part of symmetric algebra creates the representations representing the ground states of Kac-Moody representations. Restriction to these degrees of freedom gives QFT limit in string theory. In the following I will speak about "cm degrees of freedom".

The general vision about symplectic degrees of freedom (the analog of "orbital degrees of freedom" for ordinary spinor field) is following.

1. WCW (assignable to given CD) is a union over the sub-WCWs labeled by zero modes and each sub-WCW representing quantum fluctuating degrees of freedom and "cm degrees of freedom" is infinite-D symmetric space. If symplectic group assignable to  $\delta M_+^4 \times CP_2$  acts as isometries of WCW then "orbital degrees of freedom" are parametrized by the symplectic group or its coset space (note that light-cone boundary is 3-D but radial dimension is light-like so that symplectic - or rather contact structure - exists).

Let  $S^2$  be  $r_M = \text{constant}$  sphere at light-cone boundary ( $r_M$  is the radial light-like coordinate fixed apart from Lorentz transformation). The full symplectic group would act as isometries of WCW but does not - nor cannot do so - act as symmetries of Kähler action except in the huge vacuum sector of the theory correspond to vacuum extremals.

2. WCW Hamiltonians can be deduced as "fluxes" of the Hamiltonians of  $\delta M_+^4 \times CP_2$  taken over partonic 2-surfaces. These Hamiltonians expressed as products of Hamiltonians of  $S^2$  and  $CP_2$  multiplied by powers  $r_M^n$ . Note that  $r_M$  plays the role of the complex coordinate  $z$  for Kac-Moody algebras and the group  $G$  defining KM is replaced with symplectic group of  $S^2 \times CP_2$ . Hamiltonians can be assumed to have well-defined spin ( $SO(3)$ ) and color ( $SU(3)$ ) quantum numbers.
3. The generators with vanishing radial conformal weight ( $n = 0$ ) correspond to the symplectic group of  $S^2 \times CP_2$ . They are not symplectic invariants but are zero modes. They would correspond to "cm degrees of freedom" characterizing the ground states of representations of the full symplectic group.

### Discretization at the level of WCW

The general vision about finite measurement resolution implies discretization at the level of WCW.

1. Finite measurement resolution at the level of WCW means discretization. Therefore the symplectic groups of  $\delta M_+^4 \times CP_2$  resp.  $S^2 \times CP_2$  are replaced by an enumerable discrete subgroup. WCW is discretized in both quantum fluctuating degrees of freedom and "center of mass" degrees of freedom.
2. The elements of the group algebras of these discrete groups define the "orbitals parts" of WCW spinor fields in discretization. I will later develop an argument stating that they are HFFs of type II - maybe even  $II_1$ . Note that also function spaces associated with the coset spaces of these discrete subgroups could be considered.
3. Discretization applies also in the spin degrees of freedom. Since fermionic Fock basis generates quantum counterpart of Boolean algebra the interpretation in terms of the physical correlates of Boolean cognition is motivated (fermion number 1/0 and various spins in decomposition to a tensor product of lower-dimensional spinors represent bits). Note that in ZEO fermion number conservation does not pose problems and zero states actually define what might be regarded as quantum counterparts of Boolean rules  $A \rightarrow B$ .
4. Note that 3-surfaces correspond by the strong form of GCI/holography to collections of partonic 2-surfaces and string world sheets of space-time surface intersecting at discrete set of points carrying fermionic quantum numbers. WCW spinors are constructed from second quantized induced spinor fields and fermionic Fock algebra generates HFF of type  $II_1$ .

### Does WCW spinor field decompose to a tensor product of two HFFs of type $II_1$ ?

The group algebras associated with infinite discrete subgroups of the symplectic group define the discretized analogs of waves in WCW having quantum fluctuating part and cm part. The proposal is that these group algebras are HFFs of type  $II_1$ . The spinorial degrees of freedom correspond to fermionic Fock space and this is known to be HFF. Therefore WCW spinor fields would be defined as tensor product of HFFs of type  $II_1$ . The interpretation would be in terms of supersymmetry at the level of WCW. Super-conformal symmetry is indeed the basic symmetry of TGD so that this result is a physical "must". The argument goes as follows.

1. In non-zero modes WCW is symplectic group of  $\delta M_+^4 \times CP_2$  (call this group just *Sympl*) reduces to the analog of Kac-Moody group associated with  $S^2 \times CP_2$ , where  $S^2$  is  $r_M = \text{constant}$  sphere of light-cone boundary and  $z$  is replaced with radial coordinate. The Hamiltonians, which do not depend on  $r_M$  would correspond to zero modes and one could not assign metric to them although symplectic structure is possible. In "cm degrees of freedom" one has symplectic group associated with  $S^2 \times CP_2$ .
2. Finite measurement resolution, which seems to be coded already in the structure of the preferred extremals and of the solutions of the modified Dirac equation, suggests strongly that this symplectic group is replaced by its discrete subgroup or symmetric coset space. What this group is, depends on measurement resolution defined by the cutoffs inherent to the solutions. These subgroups and coset spaces would define the analogs of Platonic solids in WCW!
3. Why the discrete infinite subgroups of *Sympl* would lead naturally to HFFs of type II? There is a very general result stating that group algebra of an enumerable discrete group, which has infinite conjugacy classes, and is amenable so that its regular representation in group algebra decomposes to all unitary irreducibles is HFF of type II. See for examples about HFFs of type II listed in Wikipedia article [?].
4. Suppose that the group algebras associated the discrete subgroups *Sympl* are indeed HFFs of type II or even type  $II_1$ . Their inclusions would define finite measurement resolution the orbital degrees of freedom for WCW spinor fields. Included algebra would create rays of state space not distinguishable experimentally. The inclusion would be characterized by the inclusion of the lattice defined by the generators of included algebra by linearity. One would have inclusion of this lattice to a lattice associated with a larger discrete group. Inclusions of lattices are however known to give rise to quasicrystals (Penrose tilings are basic example), which define basic non-commutative structures. This is indeed what one expects since the dimension of the coset space defined by inclusion is algebraic number rather than integer.
5. Also in fermionic degrees of freedom finite measurement resolution would be realized in terms of inclusions of HFFs- now certainly of type  $II_1$ . Therefore one could obtain hierarchies of lattices included as quasicrystals.

What about zero modes which are symplectic invariants and define classical variables? They are certainly discretized too. One might hope that one-one correlation between zero modes (classical variables) and quantum fluctuating degrees of freedom suggested by quantum measurement theory allows to effectively eliminate them. Besides zero modes there are also modular degrees of freedom associated with partonic 2-surfaces defining together with their 4-D tangent space data basis objects by strong form of holography. Also these degrees of freedom are automatically discretized. But could one consider finite measurement resolution also in these degrees of freedom. If the symplectic group of  $S^2 \times CP_2$  defines zero modes then one could apply similar argument also in these degrees of freedom to discrete subgroups of  $S^2 \times CP_2$ .

### 13.8.3 Little Appendix: Comparison of WCW spinor fields with ordinary second quantized spinor fields

In TGD one identifies states of Hilbert space as WCW spinor fields. The analogy with ordinary spinor field helps to understand what they are. I try to explain by comparison with QFT.

### Ordinary second quantized spinor fields

Consider first ordinary fermionic QFT in fixed space-time. Ordinary spinor is attached to an space-time point and there is  $2^{D/2}$  dimensional space of spin degrees of freedom. Spinor field attaches spinor to every point of space-time in a continuous/smooth manner. Spinor fields satisfying Dirac equation define in Euclidian metric a Hilbert space with a unitary inner product. In Minkowskian case this does not work and one must introduce second quantization and Fock space to get a unitary inner product. This brings in what is essentially a basic realization of HFF of type  $II_1$  as allowed operators acting in this Fock space. It is operator algebra rather than state space which is HFF of type  $II_1$  but they are of course closely related.

### Classical WCW spinor fields as quantum states

What happens TGD where one has quantum superpositions of 4-surface/3-surfaces by GCI/partonic 2-surfaces with 4-D tangent space data by strong form of GCI.

1. First guess: space-time point is replaced with 3-surface. Point like particle becomes 3-surface representing particle. WCW spinors are fermionic Fock states at this surface. WCW spinor fields are Fock state as a functional of 3-surface. Inner product decomposes to Fock space inner product plus functional integral over 3-surfaces (no path integral!). One could speak of quantum multiverse. Not single space-time but quantum superposition of them. This quantum multiverse character is something new as compared to QFT.
2. Second guess: forced by ZEO, by geometrization of Feynman diagrams, etc.
  - (a) 3-surfaces are actually not connected 3-surfaces. They are collections of components at both ends of CD and connected to single connected structure by 4-surface. Components of 3-surface are like incoming and outgoing particles in connected Feynman diagrams. Lines are identified as regions of Euclidian signature or equivalently as the 3-D light-like boundaries between Minkowskian and Euclidian signature of the induced metric.
  - (b) Spinors(!) are defined now by the fermionic Fock space of second quantized induced spinor fields at these 3-surfaced and by holography at 4-surface. This fermionic Fock space is assigned to all multicomponent 3-surfaces defined in this manner and WCW spinor fields are defined as in the first guess. This brings integration over WCW to the inner product.
3. Third, even more improved guess: motivated by the solution ansatz for preferred extremals and for modified Dirac equation [?] giving a connection with string models.

The general solution ansatz restricts all spinor components but right-handed neutrino to string world sheets and partonic 2-surfaces: this means effective 2-dimensionality. String world sheets and partonic 2-surfaces intersect at the common ends of light-like and space-like braids at ends of CD and at along wormhole throat orbits so that effectively discretization occurs. This fermionic Fock space replaces the Fock space of ordinary second quantization.

## 13.9 Jones inclusions and cognitive consciousness

Configuration space spinors have a natural interpretation in terms of a quantum version of Boolean algebra. Beliefs of various kinds are the basic element of cognition and obviously involve a representation of the external world or part of it as states of the system defining the believer. Jones inclusions mediating unitary mappings between the spaces of configuration spaces spinors of two systems are excellent candidates for these maps, and it is interesting to find what one kind of model for beliefs this picture leads to.

The resulting quantum model for beliefs provides a cognitive interpretation for quantum groups and predicts a universal spectrum for the probabilities that a given belief is true. This spectrum depends only on the integer  $n$  characterizing the quantum phase  $q = \exp(i2\pi/n)$  characterizing the Jones inclusion. For  $n \neq \infty$  the logic is inherently fuzzy so that absolute knowledge is impossible.  $q = 1$  gives ordinary quantum logic with qbits having precise truth values after state function reduction.

### 13.9.1 Does one have a hierarchy of $U$ - and $M$ -matrices?

$U$ -matrix describes scattering of zero energy states and since zero energy states can be illustrated in terms of Feynman diagrams one can say that scattering of Feynman diagrams is in question. The initial and final states of the scattering are superpositions of Feynman diagrams characterizing the corresponding  $M$ -matrices which contain also the positive square root of density matrix as a factor.

The hypothesis that  $U$ -matrix is the tensor product of  $S$ -matrix part of  $M$ -matrix and its Hermitian conjugate would make  $U$ -matrix an object deducible by physical measurements. One cannot of course exclude that something totally new emerges. For instance, the description of quantum jumps creating zero energy state from vacuum might require that  $U$ -matrix does not reduce in this manner. One can assign to the  $U$ -matrix a square like structure with  $S$ -matrix and its Hermitian conjugate assigned with the opposite sides of a square.

One can imagine of constructing higher level physical states as composites of zero energy states by replacing the  $S$ -matrix with  $M$ -matrix in the square like structure. These states would provide a physical representation of  $U$ -matrix. One could define  $U$ -matrix for these states in a similar manner. This kind of hierarchy could be continued indefinitely and the hierarchy of higher level  $U$  and  $M$ -matrices would be labeled by a hierarchy of  $n$ -cubes,  $n = 1, 2, \dots$ . TGD inspired theory of consciousness suggests that this hierarchy can be interpreted as a hierarchy of abstractions represented in terms of physical states. This hierarchy brings strongly in mind also the hierarchies of  $n$ -algebras and  $n$ -groups and this forces to consider the possibility that something genuinely new emerges at each step of the hierarchy. A connection with the hierarchies of infinite primes [?] and Jones inclusions are suggestive.

### 13.9.2 Feynman diagrams as higher level particles and their scattering as dynamics of self consciousness

The hierarchy of inclusions of hyper-finite factors of  $II_1$  as counterpart for many-sheeted space-time lead inevitably to the idea that this hierarchy corresponds to a hierarchy of generalized Feynman diagrams for which Feynman diagrams at a given level become particles at the next level. Accepting this idea, one is led to ask what kind of quantum states these Feynman diagrams correspond, how one could describe interactions of these higher level particles, what is the interpretation for these higher level states, and whether they can be detected.

#### Jones inclusions as analogs of space-time surfaces

The idea about space-time as a 4-surface replicates itself at the level of operator algebra and state space in the sense that Jones inclusion can be seen as a representation of the operator algebra  $\mathcal{N}$  as infinite-dimensional linear sub-space (surface) of the operator algebra  $\mathcal{M}$ . This encourages to think that generalized Feynman diagrams could correspond to image surfaces in  $II_1$  factor having identification as kind of quantum space-time surfaces.

Suppose that the modular  $S$ -matrices are representable as the inner automorphisms  $\Delta(\mathcal{M}_k^{it})$  assigned to the external lines of Feynman diagrams. This would mean that  $\mathcal{N} \subset \mathcal{M}_k$  moves inside  $calM_k$  along a geodesic line determined by the inner automorphism. At the vertex the factors  $calM_k$  to fuse along  $\mathcal{N}$  to form a Connes tensor product. Hence the copies of  $\mathcal{N}$  move inside  $\mathcal{M}_k$  like incoming 3-surfaces in  $H$  and fuse together at the vertex. Since all  $\mathcal{M}_k$  are isomorphic to a universal factor  $\mathcal{M}$ , many-sheeted space-time would have a kind of quantum image inside  $II_1$  factor consisting of pieces which are  $d = \mathcal{M} : \mathcal{N}/2$ -dimensional quantum spaces according to the identification of the quantum space as subspace of quantum group to be discussed later. In the case of partonic Clifford algebras the dimension would be indeed  $d \leq 2$ .

#### The hierarchy of Jones inclusions defines a hierarchy of $S$ -matrices

It is possible to assign to a given Jones inclusion  $\mathcal{N} \subset \mathcal{M}$  an entire hierarchy of Jones inclusions  $\mathcal{M}_0 \subset \mathcal{M}_1 \subset \mathcal{M}_2, \dots$ ,  $\mathcal{M}_0 = \mathcal{N}$ ,  $\mathcal{M}_1 = \mathcal{M}$ . A possible interpretation for these inclusions would be as a sequence of topological condensations.

This sequence also defines a hierarchy of Feynman diagrams inside Feynman diagrams. The factor  $\mathcal{M}$  containing the Feynman diagram having as its lines the unitary orbits of  $\mathcal{N}$  under  $\Delta_{\mathcal{M}}$  becomes a parton in  $\mathcal{M}_1$  and its unitary orbits under  $\Delta_{\mathcal{M}_1}$  define lines of Feynman diagrams in  $\mathcal{M}_1$ . The concrete representation for  $M$ -matrix or projection of it to some subspace as entanglement coefficients of partons

at the ends of a braid assignable to the space-like 3-surface representing a vertex of a higher level Feynman diagram. In this manner quantum dynamics would be coded and simulated by quantum states.

The outcome can be said to be a hierarchy of Feynman diagrams within Feynman diagrams, a fractal structure for which many particle scattering events at a given level become particles at the next level. The particles at the next level represent dynamics at the lower level: they have the property of "being about" representing perhaps the most crucial element of conscious experience. Since net conserved quantum numbers can vanish for a system in TGD Universe, this kind of hierarchy indeed allows a realization as zero energy states. Crossing symmetry can be understood in terms of this picture and has been applied to construct a model for  $M$ -matrix at high energy limit [K17].

One might perhaps say that quantum space-time corresponds to a double inclusion and that further inclusions bring in  $N$ -parameter families of space-time surfaces.

### Higher level Feynman diagrams

The lines of Feynman diagram in  $\mathcal{M}_{n+1}$  are geodesic lines representing orbits of  $\mathcal{M}_n$  and this kind of lines meet at vertex and scatter. The evolution along lines is determined by  $\Delta_{\mathcal{M}_{n+1}}$ . These lines contain within themselves  $\mathcal{M}_n$  Feynman diagrams with similar structure and the hierarchy continues down to the lowest level at which ordinary elementary particles are encountered.

For instance, the generalized Feynman diagrams at the second level are ribbon diagrams obtained by thickening the ordinary diagrams in the new time direction. The interpretation as ribbon diagrams crucial for topological quantum computation and suggested to be realizable in terms of zero energy states in [K81] is natural. At each level a new time parameter is introduced so that the dimension of the diagram can be arbitrarily high. The dynamics is not that of ordinary surfaces but the dynamics induced by the  $\Delta_{\mathcal{M}_n}$ .

### Quantum states defined by higher level Feynman diagrams

The intuitive picture is that higher level quantum states corresponds to the self reflective aspect of existence and must provide representations for the quantum dynamics of lower levels in their own structure. This dynamics is characterized by  $M$ -matrix whose elements have representation in terms of Feynman diagrams.

1. These states correspond to zero energy states in which initial states have "positive energies" and final states have "negative energies". The net conserved quantum numbers of initial and final state partons compensate each other. Gravitational energies, and more generally gravitational quantum numbers defined as absolute values of the net quantum numbers of initial and final states do not vanish. One can say that thoughts have gravitational mass but no inertial mass.
2. States in sub-spaces of positive and negative energy states are entangled with entanglement coefficients given by  $M$ -matrix at the level below.

To make this more concrete, consider first the simplest non-trivial case. In this case the particles can be characterized as ordinary Feynman diagrams, or more precisely as scattering events so that the state is characterized by  $\hat{S} = P_{in} S P_{out}$ , where  $S$  is  $S$ -matrix and  $P_{in}$  resp.  $P_{out}$  is the projection to a subspace of initial resp. final states. An entangled state with the projection of  $S$ -matrix giving the entanglement coefficients is in question.

The larger the domains of projectors  $P_{in}$  and  $P_{out}$ , the higher the representative capacity of the state. The norm of the non-normalized state  $\hat{S}$  is  $Tr(\hat{S}\hat{S}^\dagger) \leq 1$  for  $II_1$  factors, and at the limit  $\hat{S} = S$  the norm equals to 1. Hence, by  $II_1$  property, the state always entangles infinite number of states, and can in principle code the entire  $S$ -matrix to entanglement coefficients.

The states in which positive and negative energy states are entangled by a projection of  $S$ -matrix might define only a particular instance of states for which conserved quantum numbers vanish. The model for the interaction of Feynman diagrams discussed below applies also to these more general states.

### The interaction of $\mathcal{M}_n$ Feynman diagrams at the second level of hierarchy

What constraints can one pose to the higher level reactions? How Feynman diagrams interact? Consider first the scattering at the second level of hierarchy ( $\mathcal{M}_1$ ), the first level  $\mathcal{M}_0$  being assigned to the interactions of the ordinary matter.

1. Conservation laws pose constraints on the scattering at level  $\mathcal{M}_1$ . The Feynman diagrams can transform to new Feynman diagrams only in such a manner that the net quantum numbers are conserved separately for the initial positive energy states and final negative energy states of the diagram. The simplest assumption is that positive energy matter and negative energy matter know nothing about each other and effectively live in separate worlds. The scattering matrix form Feynman diagram like states would thus be simply the tensor product  $S \otimes S^\dagger$ , where  $S$  is the  $S$ -matrix characterizing the lowest level interactions and identifiable as unitary factor of  $M$ -matrix for zero energy states. Reductionism would be realized in the sense that, apart from the new elements brought in by  $\Delta_{\mathcal{M}_n}$  defining single particle free dynamics, the lowest level would determine in principle everything occurring at the higher level providing representations about representations about... for what occurs at the basic level. The lowest level would represent the physical world and higher levels the theory about it.
2. The description of hadronic reactions in terms of partons serves as a guide line when one tries to understand higher level Feynman diagrams. The fusion of hadronic space-time sheets corresponds to the vertices  $\mathcal{M}_1$ . In the vertex the analog of parton plasma is formed by a process known as parton fragmentation. This means that the partonic Feynman diagrams belonging to disjoint copies of  $\mathcal{M}_0$  find themselves inside the same copy of  $\mathcal{M}_0$ . The standard description would apply to the scattering of the initial *resp.* final state partons.
3. After the scattering of partons hadronization takes place. The analog of hadronization in the recent case is the organization of the initial and final state partons to groups  $I_i$  and  $F_i$  such that the net conserved quantum numbers are same for  $I_i$  and  $F_i$ . These conditions can be satisfied if the interactions in the plasma phase occur only between particles belonging to the clusters labeled by the index  $i$ . Otherwise only single particle states in  $\mathcal{M}_1$  would be produced in the reactions in the generic case. The cluster decomposition of  $S$ -matrix to a direct sum of terms corresponding to partitions of the initial state particles to clusters which do not interact with each other obviously corresponds to the "hadronization". Therefore no new dynamics need to be introduced.
4. One cannot avoid the question whether the parton picture about hadrons indeed corresponds to a higher level physics of this kind. This would require that hadronic space-time sheets carry the net quantum numbers of hadrons. The net quantum numbers associated with the initial state partons would be naturally identical with the net quantum numbers of hadron. Partons and they negative energy conjugates would provide in this picture a representation of hadron about hadron. This kind of interpretation of partons would make understandable why they cannot be observed directly. A possible objection is that the net gravitational mass of hadron would be three times the gravitational mass deduced from the inertial mass of hadron if partons feed their gravitational fluxes to the space-time sheet carrying Earth's gravitational field.
5. This picture could also relate to the suggested duality between string and parton pictures [K72]. In parton picture hadron is formed from partons represented by space-like 2-surfaces  $X_i^2$  connected by join along boundaries bonds. In string picture partonic 2-surfaces are replaced with string orbits. If one puts positive and negative energy particles at the ends of string diagram one indeed obtains a higher level representation of hadron. If these pictures are dual then also in parton picture positive and negative energies should compensate each other. Interestingly, light-like 3-D causal determinants identified as orbits of partons could be interpreted as orbits of light like string word sheets with "time" coordinate varying in space-like direction.

### Scattering of Feynman diagrams at the higher levels of hierarchy

This picture generalizes to the description of higher level Feynman diagrams.

1. Assume that higher level vertices have recursive structure allowing to reduce the Feynman diagrams to ordinary Feynman diagrams by a procedure consisting of finite steps.
2. The lines of diagrams are classified as incoming or outgoing lines according to whether the time orientation of the line is positive or negative. The time orientation is associated with the time parameter  $t_n$  characterizing the automorphism  $\Delta_{\mathcal{M}}^{it_n}$ . The incoming and outgoing net quantum numbers compensate each other. These quantum numbers are basically the quantum numbers of the state at the lowest level of the hierarchy.
3. In the vertices the  $\mathcal{M}_{n+1}$  particles fuse and  $\mathcal{M}_n$  particles form the analog of quark gluon plasma. The initial and final state particles of  $\mathcal{M}_n$  Feynman diagram scatter independently and the  $S$ -matrix  $S_{n+1}$  describing the process is tensor product  $S_n \otimes S_n^\dagger$ . By the clustering property of  $S$ -matrix, this scattering occurs only for groups formed by partons formed by the incoming and outgoing particles  $\mathcal{M}_n$  particles and each outgoing  $\mathcal{M}_{n+1}$  line contains an irreducible  $\mathcal{M}_n$  diagram. By continuing the recursion one finally ends down with ordinary Feynman diagrams.

### 13.9.3 Logic, beliefs, and spinor fields in the world of classical worlds

Beliefs can be characterized as Boolean value maps  $\beta_i(p)$  telling whether  $i$  believes in proposition  $p$  or not. Additional structure is brought in by introducing the map  $\lambda_i(p)$  telling whether  $p$  is true or not in the environment of  $i$ . The task is to find quantum counterpart for this model.

#### Configuration space spinors as logic statements

In TGD framework the infinite-dimensional configuration space (CH) spinor fields defined in CH, the "world of classical worlds", describe quantum states of the Universe [K15]. CH spinor field can be regarded as a state in infinite-dimensional Fock space and are labeled by a collection of various two valued indices like spin and weak isospin. The interpretation is as a collection of truth values of logic statements one for each fermionic oscillator operator in the state. For instance, spin up and down would correspond to two possible truth values of a proposition characterized by other quantum numbers of the mode.

The hierarchy of space-time sheet could define a physical correlate for the hierarchy of higher order logics (statements about statements about...). The space-time sheet containing  $N$  fermions topologically condensed at a larger space-time sheet behaves as a fermion or boson depending on whether  $N$  is odd or even. This hierarchy has also a number theoretic counterpart: the construction of infinite primes [?] corresponds to a repeated second quantization of a super-symmetric quantum field theory.

#### Quantal description of beliefs

The question is whether TGD inspired theory of consciousness allows a fundamental description of beliefs.

1. Beliefs define a model about some subsystem of universe constructed by the believer. This model can be understood as some kind of representation of real word in the state space representing the beliefs.
2. One can wonder what is the difference between real and p-adic variants of CH spinor fields and whether they could represent reality and beliefs about reality. CH spinors (as opposed to spinor fields) are constructible in terms of fermionic oscillator operators and seem to be universal in the sense that one cannot speak about p-adic and real CH spinors as different objects. Real/ p-adic spinor fields however have real/p-adic space-time sheets as arguments. This would suggest that there is no fundamental difference between the logic statements represented by p-adic and real CH spinors.

These observations suggest a more concrete view about how beliefs emerge physically.

The idea that p-adic CH spinor fields could serve as representations of beliefs and real CH spinor fields as representations of reality looks very nice but the fact that the outcomes of p-adic-to-real phase transition and its reversal are highly non-predictable does not support it as such.



Quantum statistical determinism could however come into rescue. Belief could be represented as an ensemble of p-adic mental images resulting in transitions of real mental images representing reality to p-adic states. p-Adic ensemble average would represent the belief.

It is not at all clear whether real-to-p-adic transitions can occur at high enough rate since p-adic-to-real transition are expected to be highly irreversible. The real initial states much have nearly vanishing quantum numbers emitted in the transition to p-adic state to guarantee conservation laws (p-adic conservation laws hold true only piecewise since conserved quantities are pseudo constants). The system defined by an ensemble of real Boolean mental images representing reality would automatically generate a p-adic variant representing a belief about reality.

p-Adic CH spinors can also represent the cognitive aspects of intention whereas p-adic space-time sheets would represent its geometric aspects reflected in sensory experience. p-Adic space-time sheet could also serve only as a space-time correlate for the fundamental representation of intention in terms of p-adic CH spinor field. This view is consistent with the proposed identification of beliefs since the transitions associated with intentions *resp.* beliefs would be p-adic-to-real *resp.* real-to-p-adic.

### 13.9.4 Jones inclusions for hyperfinite factors of type $II_1$ as a model for symbolic and cognitive representations

Consider next a more detailed model for how cognitive representations and beliefs are realized at quantum level. This model generalizes trivially to symbolic representations.

The Clifford algebra of gamma matrices associated with CH spinor fields corresponds to a von Neumann algebra known as hyper-finite factor of type  $II_1$ . The mathematics of these algebras is extremely beautiful and reproduces basic mathematical structures of modern physics (conformal field theories, quantum groups, knot and braid groups,...) from the mere assumption that the world of classical worlds possesses infinite-dimensional Kähler geometry and allows spinor structure.

The almost defining feature is that the infinite-dimensional unit matrix of the Clifford algebra in question has by definition unit trace. Type  $II_1$  factors allow also what are known as Jones inclusions of Clifford algebras  $\mathcal{N} \subset \mathcal{M}$ . What is special to  $II_1$  factors is that the induced unitary mappings between spinor spaces are genuine inclusions rather than 1-1 maps.

The S-matrix associated with the real-to-p-adic quantum transition inducing belief from reality would naturally define Jones inclusion of CH Clifford algebra  $\mathcal{N}$  associated with the real space-time sheet to the Clifford algebra  $\mathcal{M}$  associated with the p-adic space-time sheet. The moduli squared of S-matrix elements would define probabilities for pairs or real and belief states.

In Jones inclusion  $\mathcal{N} \subset \mathcal{M}$  the factor  $\mathcal{N}$  is included in factor  $\mathcal{M}$  such that  $\mathcal{M}$  can be expressed as  $\mathcal{N}$ -module over quantum space  $\mathcal{M}/\mathcal{N}$  which has fractal dimension given by Jones index  $\mathcal{M} : \mathcal{N} = 4\cos^2(\pi/n) \leq 4$ ,  $n = 3, 4, \dots$  varying in the range  $[1, 4]$ . The interpretation is as the fractal dimension corresponding to a dimension of Clifford algebra acting in  $d = \sqrt{\mathcal{M} : \mathcal{N}}$ -dimensional spinor space:  $d$  varies in the range  $[1, 2]$ . The interpretation in terms of a quantal variant of logic is natural.

#### Probabilistic beliefs

For  $\mathcal{M} : \mathcal{N} = 4$  ( $n = \infty$ ) the dimension of spinor space is  $d = 2$  and one can speak about ordinary 2-component spinors with  $\mathcal{N}$ -valued coefficients representing generalizations of qubits. Hence the inclusion of a given  $\mathcal{N}$ -spinor as  $\mathcal{M}$ -spinor can be regarded as a belief on the proposition and for the decomposition to a spinor in  $\mathcal{N}$ -module  $\mathcal{M}/\mathcal{N}$  involves for each index a choice  $\mathcal{M}/\mathcal{N}$  spinor component selecting super-position of up and down spins. Hence one has a superposition of truth values in general and one can speak only about probabilistic beliefs. It is not clear whether one can choose the basis in such a manner that  $\mathcal{M}/\mathcal{N}$  spinor corresponds always to truth value 1. Since CH spinor field is in question and even if this choice might be possible for a single 3-surface, it need not be possible for deformations of it so that at quantum level one can only speak about probabilistic beliefs.

#### Fractal probabilistic beliefs

For  $d < 2$  the spinor space associated with  $\mathcal{M}/\mathcal{N}$  can be regarded as quantum plane having complex quantum dimension  $d$  with two non-commuting complex coordinates  $z^1$  and  $z^2$  satisfying  $z^1 z^2 = q z^2 z^1$  and  $\bar{z}^1 z^2 = \bar{q} z^2 z^1$ . These relations are consistent with hermiticity of the real and imaginary parts of

$z^1$  and  $z^2$  which define ordinary quantum planes. Hermiticity also implies that one can identify the complex conjugates of  $z^i$  as Hermitian conjugates.

The further commutation relations  $[z^1, z^2] = [z^2, \bar{z}^1] = 0$  and  $[z^1, \bar{z}^1] = [z^2, \bar{z}^2] = r$  give a closed algebra satisfying Jacobi identities. One could argue that  $r \geq 0$  should be a function  $r(n)$  of the quantum phase  $q = \exp(i2\pi/n)$  vanishing at the limit  $n \rightarrow \infty$  to guarantee that the algebra becomes commutative at this limit and truth values can be chosen to be non-fuzzy.  $r = \sin(\pi/n)$  would be the simplest choice. As will be found, the choice of  $r(n)$  does not however affect at all the spectrum for the probabilities of the truth values.  $n = \infty$  case corresponding to non-fuzzy quantum logic is also possible and must be treated separately: it corresponds to Kac Moody algebra instead of quantum groups.

The non-commutativity of complex spinor components means that  $z^1$  and  $z^2$  are not independent coordinates: this explains the reduction of the number of the effective number of truth values to  $d < 2$ . The maximal reduction occurs to  $d = 1$  for  $n = 3$  so that there is effectively only single truth value and one could perhaps speak about taboo or dogma or complete disappearance of the notions of truth and false (this brings in mind reports about meditative states: in fact  $n = 3$  corresponds to a phase in which Planck constant becomes infinite so that the system is maximally quantal).

As non-commuting operators the components of  $d$ -spinor are not simultaneously measurable for  $d < 2$ . It is however possible to measure simultaneously the operators describing the probabilities  $z^1 \bar{z}^1$  and  $z^2 \bar{z}^2$  for truth values since these operators commute. An inherently fuzzy Boolean logic would be in question with the additional feature that the spinorial counterparts of statement and its negation cannot be regarded as independent observables although the corresponding probabilities satisfy the defining conditions for commuting observables.

If one can speak of a measurement of probabilities for  $d < 2$ , it differs from the ordinary quantum measurement in the sense that it cannot involve a state function reduction to a pure qubit meaning irreducible quantal fuzziness. One could speak of fuzzy qbits or fqbits (or quantum qbits) instead of qbits. This picture would provide the long sought interpretation for quantum groups.

The previous picture applies to all representations  $M_1 \subset M_2$ , where  $M_1$  and  $M_2$  denote either real or p-adic Clifford algebras for some prime  $p$ . For instance, real-real Jones inclusion could be interpreted as symbolic representations assignable to a unitary mapping of the states of a subsystem  $M_1$  of the external world to the state space  $M_2$  of another real subsystem.  $p_1 \rightarrow p_2$  unitary inclusions would in turn map cognitive representations to cognitive representations. There is a strong temptation to assume that these Jones inclusions define unitary maps realizing universe as a universal quantum computer mimicking itself at all levels utilizing cognitive and symbolic representations. Subsystem-system inclusion would naturally define one example of Jones inclusion.

### The spectrum of probabilities of truth values is universal

It is actually possible to calculate the spectrum of the probabilities of truth values with rather mild additional assumptions.

1. Since the Hermitian operators  $X_1 = (z^1 \bar{z}^1 + \bar{z}^1 z^1)/2$  and  $X_2 = (z^2 \bar{z}^2 + \bar{z}^2 z^2)/2$  commute, physical states can be chosen to be eigen states of these operators and it is possible to assign to the truth values probabilities given by  $p_1 = X_1/R^2$  and  $p_2 = X_2/R^2$ ,  $R^2 = X_1 + X_2$ .
2. By introducing the analog of the harmonic oscillator vacuum as a state  $|0\rangle$  satisfying  $z^1|0\rangle = z^2|0\rangle = 0$ , one obtains eigen states of  $X_1$  and  $X_2$  as states  $|n_1, n_2\rangle = \bar{z}^{1n_1} \bar{z}^{2n_2} |0\rangle$ ,  $n_1 \geq 0, n_2 \geq 0$ . The eigenvalues of  $X_1$  and  $X_2$  are given by a modified harmonic oscillator spectrum as  $(1/2 + n_1 q^{n_2})r$  and  $(1/2 + n_2 q^{n_1})r$ . The reality of eigenvalues (hermiticity) is guaranteed if one has  $n_1 = N_1 n$  and  $n_2 = N_2 n$  and implies that the spectrum of eigen states gets increasingly thinner for  $n \rightarrow \infty$ . This must somehow reflect the fractal dimension. The fact that large values of oscillator quantum numbers  $n_1$  and  $n_2$  correspond to the classical limit suggests that modulo condition guarantees approximate classicality of the logic for  $n \rightarrow \infty$ .
3. The probabilities  $p_1$  and  $p_2$  for the truth values given by  $(p_1, p_2) = (1/2 + N_1 n, 1/2 + N_2 n)/[1 + (N_1 + N_2)n]$  are rational and allow an interpretation as both real and p-adic numbers. All states are inherently fuzzy and only at the limits  $N_1 \gg N_2$  and  $N_2 \gg N_1$  non-fuzzy states result. As noticed,  $n = \infty$  must be treated separately and corresponds to an ordinary non-fuzzy qbit

logic. At  $n \rightarrow \infty$  limit one has  $(p_1, p_2) = (N_1, N_2)/(N_1, N_2)$ : at this limit  $N_1 = 0$  or  $N_2 = 0$  states are non-fuzzy.

### How to define variants of belief quantum mechanically?

Probabilities of true and false for Jones inclusion characterize the plausibility of the belief and one can ask whether this description is enough to characterize states such as knowledge, misbelief, doubt, delusion, and ignorance. The truth value of  $\beta_i(p)$  is determined by the measurement of probability assignable to Jones inclusion on the p-adic side. The truth value of  $\lambda_i(p)$  is determined by a similar measurement on the real side.  $\beta$  and  $\lambda$  appear completely symmetrically and one can consider all kinds of triplets  $\mathcal{M}_1 \subset \mathcal{M}_2 \subset \mathcal{M}_3$  assuming that there exist unitary S-matrix like maps mediating a sequence  $\mathcal{M}_1 \subset \mathcal{M}_2 \subset \mathcal{M}_3$  of Jones inclusions. Interestingly, the hierarchies of Jones inclusions are a key concept in the theory of hyper-finite factors of type  $II_1$  and pair of inclusions plays a fundamental role.

Let us restrict the consideration to the situation when  $\mathcal{M}_1$  corresponds to a real subsystem of the external world,  $\mathcal{M}_2$  its real representation by a real subsystem, and  $\mathcal{M}_3$  to p-adic cognitive representation of  $\mathcal{M}_3$ . Assume that both real and p-adic sides involve a preferred state basis for qubits representing truth and false.

Assume first that both  $\mathcal{M}_1 \subset \mathcal{M}_2$  and  $\mathcal{M}_2 \subset \mathcal{M}_3$  correspond to  $d = 2$  case for which ordinary quantum measurement or truth value is possible giving outcome true or false. Assume further that the truth values have been measured in both  $\mathcal{M}_2$  and  $\mathcal{M}_3$ .

1. Knowledge corresponds to the proposition  $\beta_i(p) \wedge \lambda_i(p)$ .
2. Misbelief to the proposition  $\beta_i(p) \wedge \neq \lambda_i(p)$ .  
Knowledge and misbelief would involve both the measurement of real and p-adic probabilities .
3. Assume next that one has  $d < 2$  form  $\mathcal{M}_2 \subset \mathcal{M}_3$ . Doubt can be regarded neither belief or disbelief:  $\beta_i(p) \wedge \neq \beta_i(\neq p)$ : belief is inherently fuzzy although proposition can be non-fuzzy.  
Assume next that truth values in  $\mathcal{M}_1 \subset \mathcal{M}_2$  inclusion corresponds to  $d < 2$  so that the basic propositions are inherently fuzzy.
4. Delusion is a belief which cannot be justified:  $\beta_i(p) \wedge \lambda_i(p) \wedge \neq \lambda(\neq p)$ . This case is possible if  $d = 2$  holds true for  $\mathcal{M}_2 \subset \mathcal{M}_3$ . Note that also misbelief that cannot be shown wrong is possible.  
In this case truth values cannot be quantum measured for  $\mathcal{M}_1 \subset \mathcal{M}_2$  but can be measured for  $\mathcal{M}_2 \subset \mathcal{M}_3$ . Hence the states are products of pure  $\mathcal{M}_3$  states with fuzzy  $\mathcal{M}_2$  states.
5. Ignorance corresponds to the proposition  $\beta_i(p) \wedge \neq \beta_i(\neq p) \wedge \lambda_i(p) \wedge \neq \lambda(\neq p)$ . Both real representational states and belief states are inherently fuzzy.

Quite generally, only for  $d_1 = d_2 = 2$  ideal knowledge and ideal misbelief are possible. Fuzzy beliefs and logics approach to ordinary one at the limit  $n \rightarrow \infty$ , which according to the proposal of [K65] corresponds to the ordinary value of Planck constant. For other cases these notions are only approximate and quantal approach allows to characterize the goodness of the approximation. A new kind of inherent quantum uncertainty of knowledge is in question and one could speak about a Uncertainty Principle for cognition and symbolic representations. Also the unification of symbolic and various kinds of cognitive representations deserves to be mentioned.

### 13.9.5 Intentional comparison of beliefs by topological quantum computation?

Intentional comparison would mean that for a given initial state also the final state of the quantum jump is fixed. This requires the ability to engineer S-matrix so that it leads from a given state to single state only. Any S-matrix representing permutation of the initial states fulfills these conditions. This condition is perhaps unnecessarily strong.

Quantum computation is basically the engineering of S-matrix so that it represents a superposition of parallel computations. In TGD framework topological quantum computation based on the braiding of magnetic flux tubes would be represented as an evolution characterized by braid [K81] . The

dynamical evolution would be associated with light-like boundaries of braids. This evolution has dual interpretations either as a limit of time evolution of quantum state (program running) or a quantum state satisfying conformal invariance constraints (program code).

The dual interpretation would mean that conformally invariant states are equivalent with engineered time evolutions and topological computation realized as braiding connecting the quantum states to be compared (beliefs represented as many-fermion states at the boundaries of magnetic flux tubes) could give rise to conscious computational comparison of beliefs. The complexity of braiding would give a measure for how much the states to be compared differ.

Note that quantum computation is defined by a unitary map which could also be interpreted as symbolic representation of states of system  $M_1$  as states of system  $M_2$  mediated by the braid of join along boundaries bonds connecting the two space-time sheets in question and having light-like boundaries. These considerations suggest that the idea about S-matrix of the Universe should be generalized so that the dynamics of the Universe is dynamics of mimicry described by an infinite collection of fermionic S-matrices representable in terms of Jones inclusions.

### 13.9.6 The stability of fuzzy qbits and quantum computation

The stability of fqbts against state function reduction might have deep implications for quantum computation since quantum spinors would be stable against state function reduction induced by the perturbations inducing de-coherence in the normal situation. If this is really true, and if the only dangerous perturbations are those inducing the phase transition to qbits, the implications for quantum computation could be dramatic. Of course, the rigidity of qbits could be just another way to say that topological quantum computations are stable against thermal perturbations not destroying anyons [K81].

The stability of fqbts could also be another manner to state the stability of rational, or more generally algebraic, bound state entanglement against state function reduction, which is one of the basic hypothesis of TGD inspired theory of consciousness [K41]. For sequences of Jones inclusions or equivalently, for multiple Connes tensor products, one would obtain tensor products of quantum spinors making possible arbitrary complex configurations of fqbts. Anyonic braids in topological quantum computation would have interpretation as representations for this kind of tensor products.

### 13.9.7 Fuzzy quantum logic and possible anomalies in the experimental data for the EPR-Bohm experiment

The experimental data for EPR-Bohm experiment [?] excluding hidden variable interpretations of quantum theory. What is less known that the experimental data indicates about possibility of an anomaly challenging quantum mechanics [?]. The obvious question is whether this anomaly might provide a test for the notion of fuzzy quantum logic inspired by the TGD based quantum measurement theory with finite measurement resolution.

#### The anomaly

The experimental situation involves emission of two photons from spin zero system so that photons have opposite spins. What is measured are polarizations of the two photons with respect to polarization axes which differ from standard choice of this axis by rotations around the axis of photon momentum characterized by angles  $\alpha$  and  $\beta$ . The probabilities for observing polarizations  $(i, j)$ , where  $i, j$  is taken  $Z_2$  valued variable for a convenience of notation are  $P_{ij}(\alpha, \beta)$ , are predicted to be  $P_{00} = P_{11} = \cos^2(\alpha - \beta)/2$  and  $P_{01} = P_{10} = \sin^2(\alpha - \beta)/2$ .

Consider now the discrepancies.

1. One has four identities  $P_{i,i} + P_{i,i+1} = P_{ii} + P_{i+1,i} = 1/2$  having interpretation in terms of probability conservation. Experimental data of [?] are not consistent with this prediction [?] and this is identified as the anomaly.
2. The QM prediction  $E(\alpha, \beta) = \sum_i (P_{i,i} - P_{i,i+1}) = \cos(2(\alpha - \beta))$  is not satisfied neither: the maxima for the magnitude of  $E$  are scaled down by a factor  $\simeq .9$ . This deviation is not discussed in [?].

Both these findings raise the possibility that QM might not be consistent with the data. It turns out that fuzzy quantum logic predicted by TGD and implying that the predictions for the probabilities and correlation must be replaced by ensemble averages, can explain anomaly b) but not anomaly a). A "mundane" explanation for anomaly a) is proposed.

### Predictions of fuzzy quantum logic for the probabilities and correlations

#### 1. The description of fuzzy quantum logic in terms statistical ensemble

The fuzzy quantum logic implies that the predictions  $P_{i,j}$  for the probabilities should be replaced with ensemble averages over the ensembles defined by fuzzy quantum logic. In practice this means that following replacements should be carried out:

$$\begin{aligned} P_{i,j} &\rightarrow P^2 P_{i,j} + (1-P)^2 P_{i+1,j+1} \\ &+ P(1-P) [P_{i,j+1} + P_{i+1,j}] . \end{aligned} \quad (13.9.1)$$

Here  $P$  is one of the state dependent universal probabilities/fuzzy truth values for some value of  $n$  characterizing the measurement situation. The concrete predictions would be following

$$\begin{aligned} P_{0,0} = P_{1,1} &\rightarrow A \frac{\cos^2(\alpha - \beta)}{2} + B \frac{\sin^2(\alpha - \beta)}{2} \\ &= (A - B) \frac{\cos^2(\alpha - \beta)}{2} + \frac{B}{2} , \\ P_{0,1} = P_{1,0} &\rightarrow A \frac{\sin^2(\alpha - \beta)}{2} + B \frac{\cos^2(\alpha - \beta)}{2} \\ &= (A - B) \frac{\sin^2(\alpha - \beta)}{2} + \frac{B}{2} , \\ A &= P^2 + (1 - P)^2 , \quad B = 2P(1 - P) . \end{aligned} \quad (13.9.2)$$

The prediction is that the graphs of probabilities as a function as function of the angle  $\alpha - \beta$  are scaled by a factor  $1 - 4P(1 - P)$  and shifted upwards by  $P(1 - P)$ . The value of  $P$ , and one might hope even the value of  $n$  labeling Jones inclusion and the integer  $m$  labeling the quantum state might be deducible from the experimental data as the upward shift. The basic prediction is that the maxima of curves measuring probabilities  $P(i, j)$  have minimum at  $B/2 = P(1 - P)$  and maximum is scaled down to  $(A - B)/2 = 1/2 - 2P(1 - P)$ .

If the  $P$  is same for all pairs  $i, j$ , the correlation  $E = \sum_i (P_{ii} - P_{i,i+1})$  transforms as

$$E(\alpha, \beta) \rightarrow [1 - 4P(1 - P)] E(\alpha, \beta) . \quad (13.9.3)$$

Only the normalization of  $E(\alpha, \beta)$  as a function of  $\alpha - \beta$  reducing the magnitude of  $E$  occurs. In particular the maximum/minimum of  $E$  are scaled down from  $E = \pm 1$  to  $E = \pm(1 - 4P(1 - P))$ .

From the figure 1b) of [?] the scaling down indeed occurs for magnitudes of  $E$  with same amount for minimum and maximum. Writing  $P = 1 - \epsilon$  one has  $A - B \simeq 1 - 4\epsilon$  and  $B \simeq 2\epsilon$  so that the maximum is in the first approximation predicted to be at  $1 - 4\epsilon$ . The graph would give  $1 - P \simeq \epsilon \simeq .025$ . Thus the model explains the reduction of the magnitude for the maximum and minimum of  $E$  which was not however considered to be an anomaly in [?, ?] .

A further prediction is that the identities  $P(i, i) + P(i + 1, i) = 1/2$  should still hold true since one has  $P_{i,i} + P_{i,i+1} = (A - B)/2 + B = 1$ . This is implied also by probability conservation. The four curves corresponding to these identities do not however co-incide as the figure 6 of [?] demonstrates. This is regarded as the basic anomaly in [?, ?] . From the same figure it is also clear that below  $\alpha - \beta < 10$  degrees  $P_{++} = P_{--}$   $\Delta P_{+-} = -\Delta P_{-+}$  holds true in a reasonable approximation. After that one has also non-vanishing  $\Delta P_{ii}$  satisfying  $\Delta P_{++} = -\Delta P_{--}$ . This kind of splittings guarantee the identity  $\sum_{ij} P_{ij} = 1$ . These splittings are not visible in  $E$ .

Since probability conservation requires  $P_{ii} + P_{i+1,i} = 1$ , a mundane explanation for the discrepancy could be that the failure of the conditions  $P_{i,i} + P_{i+1,i} = 1$  means that the measurement efficiency is

too low for  $P_{+-}$  and yields too low values of  $P_{+-} + P_{--}$  and  $P_{+-} + P_{++}$ . The constraint  $\sum_{i,j} P_{ij} = 1$  would then yield too high value for  $P_{-+}$ . Similar reduction of measurement efficiency for  $P_{++}$  could explain the splitting for  $\alpha - \beta > 10$  degrees.

Clearly asymmetry with respect to exchange of photons or of detectors is in question.

1. The asymmetry of two photon state with respect to the exchange of photons could be considered as a source of asymmetry. This would mean that the photons are not maximally entangled. This could be seen as an alternative "mundane" explanation.
2. The assumption that the parameter  $P$  is different for the detectors does not change the situation as is easy to check.
3. One manner to achieve splittings which resemble observed splittings is to assume that the value of the probability parameter  $P$  depends on the *polarization pair*:  $P = P(i, j)$  so that one has  $(P(-, +), P(+, -)) = (P + \Delta, P - \Delta)$  and  $(P(-, -), P(+, +)) = (P + \Delta_1, P - \Delta_1)$ .  $\Delta \simeq .025$  and  $\Delta_1 \simeq \Delta/2$  could produce the observed splittings qualitatively. One would however always have  $P(i, i) + P(i, i + 1) \geq 1/2$ . Only if the procedure extracting the correlations uses the constraint  $\sum_{i,j} P_{ij} = 1$  effectively inducing a constant shift of  $P_{ij}$  downwards an asymmetry of observed kind can result. A further objection is that there are no special reason for the values of  $P(i, j)$  to satisfy the constraints.

2. *Is it possible to say anything about the value of  $n$  in the case of EPR-Bohm experiment?*

To explain the reduction of the maximum magnitudes of the correlation  $E$  from 1 to  $\sim .9$  in the experiment discussed above one should have  $p_1 \simeq .9$ . It is interesting to look whether this allows to deduce any information about the value of  $n$ . At the limit of large values of  $N_i n$  one would have  $(N_1 - N_2)/(N_1 + N_2) \simeq .4$  so that one cannot say anything about  $n$  in this case.  $(N_1, N_2) = (3, 1)$  satisfies the condition exactly. For  $n = 3$ , the smallest possible value of  $n$ , this would give  $p_1 \simeq .88$  and for  $n = 4$   $p_1 = .41$ . With high enough precision it might be possible to select between  $n = 3$  and  $n = 4$  options if small values of  $N_i$  are accepted.

### 13.9.8 Category theoretic formulation for quantum measurement theory with finite measurement resolution?

I have been trying to understand whether category theory might provide some deeper understanding about quantum TGD, not just as a powerful organizer of fuzzy thoughts but also as a tool providing genuine physical insights. Marni Dee Sheppard (or Kea in her blog Arcadian Functor at <http://keamonad.blogspot.com/>) is also interested in categories but in much more technical sense. Her dream is to find a category theoretical formulation of M-theory as something, which is not the 11-D something making me rather unhappy as a physicist with second foot still deep in the muds of low energy phenomenology.

#### Locales, frames, Sierpinski topologies and Sierpinski space

The ideas below popped up when Kea mentioned in M-theory lesson 51 the notions of locale and frame [?]. In Wikipedia I learned that complete Heyting algebras, which are fundamental to category theory, are objects of three categories with differing arrows. CHey, Loc and its opposite category Frm (arrows reversed). Complete Heyting algebras are partially ordered sets which are complete lattices. Besides the basic logical operations there is also algebra multiplication (I have considered the possible role of categories and Heyting algebras in TGD in [?]). From Wikipedia I also learned that locales and the dual notion of frames form the foundation of pointless topology [?]. These topologies are important in topos theory which does not assume axiom of choice.

The so called particular point topology [?] assumes a selection of single point but I have the physicist's feeling that it is otherwise rather near to pointless topology. Sierpinski topology [?] is this kind of topology. Sierpinski topology is defined in a simple manner: the set is open only if it contains a given preferred point  $p$ . The dual of this topology defined in the obvious sense exists also. Sierpinski space consisting of just two points 0 and 1 is the universal building block of these topologies in the sense that a map of an arbitrary space to Sierpinski space provides it with Sierpinski topology as the

induced topology. In category theoretical terms Sierpinski space is the initial object in the category of frames and terminal object in the dual category of locales. This category theoretic reductionism looks highly attractive.

### Particular point topologies, their generalization, and number theoretic braids

Pointless, or rather particular point topologies might be very interesting from physicist's point of view. After all, every classical physical measurement has a finite space-time resolution. In TGD framework discretization by number theoretic braids replaces partonic 2-surface with a discrete set consisting of algebraic points in some extension of rationals: this brings in mind something which might be called a topology with a set of particular algebraic points. Could this preferred set belongs to any open set in the particular point topology appropriate in this situation?

Perhaps the physical variant for the axiom of choice could be restricted so that only sets of algebraic points in some extension of rationals can be chosen freely and the choices is defined by the intersection of p-adic and real partonic 2-surfaces and in the framework of TGD inspired theory of consciousness would thus involve the interaction of cognition and intentionality with the material world. The extension would depend on the position of the physical system in the algebraic evolutionary hierarchy defining also a cognitive hierarchy. Certainly this would fit very nicely to the formulation of quantum TGD unifying real and p-adic physics by gluing real and p-adic number fields to single super-structure via common algebraic points.

### Analogs of particular point topologies at the level of state space: finite measurement resolution

There is also a finite measurement resolution in Hilbert space sense not taken into account in the standard quantum measurement theory based on factors of type I. In TGD framework one indeed introduces quantum measurement theory with a finite measurement resolution so that complex rays become included hyper-finite factors of type  $II_1$  (HFFs).

1. Could topology with particular algebraic points have a generalization allowing a category theoretic formulation of the quantum measurement theory without states identified as complex rays?
2. How to achieve this? In the transition of ordinary Boolean logic to quantum logic in the old fashioned sense (von Neuman again!) the set of subsets is replaced with the set of subspaces of Hilbert space. Perhaps this transition has a counterpart as a transition from Sierpinski topology to a structure in which sub-spaces of Hilbert space are quantum sub-spaces with complex rays replaced with the orbits of subalgebra defining the measurement resolution. Sierpinski space  $\{0,1\}$  would in this generalization be replaced with the quantum counterpart of the space of 2-spinors. Perhaps one should also introduce q-category theory with Heyting algebra being replaced with q-quantum logic.

### Fuzzy quantum logic as counterpart for Sierpinski space

The program formulated above might indeed make sense. The lucky association induced by Kea's blog was to the ideas about fuzzy quantum logic realized in terms of quantum 2-spinor that I had developed a couple of years ago. Fuzzy quantum logic would reflect the finite measurement resolution. I just list the pieces of the argument.

**Spinors and qbits:** Spinors define a quantal variant of Boolean statements, qbits. One can however go further and define the notion of quantum qbit, qqbit. I indeed did this for couple of years ago (the last section of this chapter).

**Q-spinors and qqbits:** For q-spinors the two components  $a$  and  $b$  are not commuting numbers but non-Hermitian operators:  $ab = qba$ ,  $q$  a root of unity. This means that one cannot measure both  $a$  and  $b$  simultaneously, only either of them.  $aa^\dagger$  and  $bb^\dagger$  however commute so that probabilities for bits 1 and 0 can be measured simultaneously. State function reduction is not possible to a state in which  $a$  or  $b$  gives zero. The interpretation is that one has q-logic is inherently fuzzy: there are no absolute truths or falsehoods. One can actually predict the spectrum of eigenvalues of probabilities for say 1. Obviously quantum spinors would be state space counterparts of Sierpinski space and for

$q \neq 1$  the choice of preferred spinor component is very natural. Perhaps this fuzzy quantum logic replaces the logic defined by the Heyting algebra.

**Q-locale:** Could one think of generalizing the notion of locale to quantum locale by using the idea that sets are replaced by sub-spaces of Hilbert space in the conventional quantum logic. Q-openness would be defined by identifying quantum spinors as the initial object,  $q$ -Sierpinski space.  $a$  (resp.  $b$  for the dual category) would define  $q$ -open set in this space. Q-open sets for other quantum spaces would be defined as inverse images of  $a$  (resp.  $b$ ) for morphisms to this space. Only for  $q=1$  one could have the  $q$ -counterpart of rather uninteresting topology in which all sets are open and every map is continuous.

**Q-locale and HFFs:** The  $q$ -Sierpinski character of  $q$ -spinors would conform with the very special role of Clifford algebra in the theory of HFFs, in particular, the special role of Jones inclusions to which one can assign spinor representations of  $SU(2)$ . The Clifford algebra and spinors of the world of classical worlds identifiable as Fock space of quark and lepton spinors is the fundamental example in which 2-spinors and corresponding Clifford algebra serves as basic building brick although tensor powers of any matrix algebra provides a representation of HFF.

**Q-measurement theory:** Finite measurement resolution ( $q$ -quantum measurement theory) means that complex rays are replaced by sub-algebra rays. This would force the Jones inclusions associated with  $SU(2)$  spinor representation and would be characterized by quantum phase  $q$  and bring in the  $q$ -topology and  $q$ -spinors. Fuzzyness of  $q$ qbits of course correlates with the finite measurement resolution.

**Q-n-logos:** For other  $q$ -representations of  $SU(2)$  and for representations of compact groups (Appendix) one would obtain something which might have something to do with quantum  $n$ -logos, quantum generalization of  $n$ -valued logic. All of these would be however less fundamental and induced by  $q$ -morphisms to the fundamental representation in terms of spinors of the world of classical worlds. What would be however very nice that if these  $q$ -morphisms are constructible explicitly it would become possible to build up  $q$ -representations of various groups using the fundamental physical realization - and as I have conjectured [K61] - McKay correspondence and huge variety of its generalizations would emerge in this manner.

**The analogs of Sierpinski spaces:** The discrete subgroups of  $SU(2)$ , and quite generally, the groups  $Z_n$  associated with Jones inclusions and leaving the choice of quantization axes invariant, bring in mind the  $n$ -point analogs of Sierpinski space with unit element defining the particular point. Note however that  $n \geq 3$  holds true always so that one does not obtain Sierpinski space itself. If all these  $n$  preferred points belong to any open set it would not be possible to decompose this preferred set to two subsets belonging to disjoint open sets. Recall that the generalized imbedding space related to the quantization of Planck constant is obtained by gluing together coverings  $M^4 \times CP_2 \rightarrow M^4 \times CP_2/G_a \times G_b$  along their common points of base spaces. The topology in question would mean that if some point in the covering belongs to an open set, all of them do so. The interpretation would be that the points of fiber form a single inseparable quantal unit.

Number theoretical braids identified as subsets of the intersection of real and  $p$ -adic variants of algebraic partonic 2-surface define a second candidate for the generalized Sierpinski space with a set of preferred points.

### 13.10 Appendix: Inclusions of hyper-finite factors of type $II_1$

Many names have been assigned to inclusions: Jones, Wenzl, Ocneanu, Pimsner-Popa, Wasserman [?] . It would seem to me that the notion Jones inclusion includes them all so that various names would correspond to different concrete realizations of the inclusions conjugate under outer automorphisms.

1. According to [?] for inclusions with  $\mathcal{M} : \mathcal{N} \leq 4$  (with  $A_1^{(1)}$  excluded) there exists a countable infinity of sub-factors which are pairwise non inner conjugate but conjugate to  $\mathcal{N}$ .
2. Also for any finite group  $G$  and its outer action there exists uncountably many sub-factors which are pairwise non inner conjugate but conjugate to the fixed point algebra of  $G$  [?] . For any amenable group  $G$  the the inclusion is also unique apart from outer automorphism [?] .

Thus it seems that not only Jones inclusions but also more general inclusions are unique apart from outer automorphism.



Any  $*$ -endomorphism  $\sigma$ , which is unit preserving, faithful, and weakly continuous, defines a sub-factor of type  $II_1$  factor [?]. The construction of Jones leads to a standard inclusion sequence  $\mathcal{N} \subset \mathcal{M} \subset \mathcal{M}^1 \subset \dots$ . This sequence means addition of projectors  $e_i, i < 0$ , having visualization as an addition of braid strand in braid picture. This hierarchy exists for all factors of type II. At the limit  $\mathcal{M}^\infty = \cup_i \mathcal{M}^i$  the braid sequence extends from  $-\infty$  to  $\infty$ . Inclusion hierarchy can be understood as a hierarchy of Connes tensor powers  $\mathcal{M} \otimes_{\mathcal{N}} \mathcal{M} \dots \otimes_{\mathcal{N}} \mathcal{M}$ . Also the ordinary tensor powers of hyper-finite factors of type  $II_1$  (HFF) as well as their tensor products with finite-dimensional matrix algebras are isomorphic to the original HFF so that these objects share the magic of fractals.

Under certain assumptions the hierarchy can be continued also in opposite direction. For a finite index an infinite inclusion hierarchy of factors results with the same value of index.  $\sigma$  is said to be basic if it can be extended to  $*$ -endomorphisms from  $\mathcal{M}^1$  to  $\mathcal{M}$ . This means that the hierarchy of inclusions can be continued in the opposite direction: this means elimination of strands in the braid picture. For finite factors (as opposed to hyper-finite ones) there are no basic  $*$ -endomorphisms of  $\mathcal{M}$  having fixed point algebra of non-abelian  $G$  as a sub-factor [?].

### 13.10.1 Jones inclusions

For hyper-finite factors of type  $II_1$  Jones inclusions allow basic  $*$ -endomorphism. They exist for all values of  $\mathcal{M} : \mathcal{N} = r$  with  $r \in \{4\cos^2(\pi/n) | n \geq 3\} \cap [4, \infty)$  [?]. They are defined for an algebra defined by projectors  $e_i, i \geq 1$ . All but nearest neighbor projectors commute.  $\lambda = 1/r$  appears in the relations for the generators of the algebra given by  $e_i e_j e_i = \lambda e_i, |i - j| = 1$ .  $\mathcal{N} \subset \mathcal{M}$  is identified as the double commutator of algebra generated by  $e_i, i \geq 2$ .

This means that principal graph and its dual are equivalent and the braid defined by projectors can be continued not only to  $-\infty$  but that also the dropping of arbitrary number of strands is possible [?]. It would seem that ADE property of the principal graph meaning single root length codes for the duality in the case of  $r \leq 4$  inclusions.

Irreducibility holds true for  $r < 4$  in the sense that the intersection of  $Q' \cap P = P' \cap P = C$ . For  $r \geq 4$  one has  $\dim(Q' \cap P) = 2$ . The operators commuting with  $Q$  contain besides identify operator of  $Q$  also the identify operator of  $P$ .  $Q$  would contain a single finite-dimensional matrix factor less than  $P$  in this case. Basic  $*$ -endomorphisms with  $\sigma(P) = Q$  is  $\sigma(e_i) = e_{i+1}$ . The difference between genuine symmetries of quantum TGD and symmetries which can be mimicked by TGD could relate to the irreducibility for  $r < 4$  and raise these inclusions in a unique position. This difference could partially justify the hypothesis [K25] that only the groups  $G_a \times G_b \subset SU(2) \times SU(2) \subset SL(2, C) \times SU(3)$  define orbifold coverings of  $H_\pm = M_\pm^4 \times CP_2 \rightarrow H_\pm/G_a \times G_b$ .

### 13.10.2 Wassermann's inclusion

Wasserman's construction of  $r = 4$  factors clarifies the role of the subgroup of  $G \subset SU(2)$  for these inclusions. Also now  $r = 4$  inclusion is characterized by a discrete subgroup  $G \subset SU(2)$  and is given by  $(1 \otimes \mathcal{M})^G \subset (M_2(C) \times \mathcal{M})^G$ . According to [?] Jones inclusions are irreducible also for  $r = 4$ . The definition of Wasserman inclusion for  $r = 4$  seems however to imply that the identity matrices of both  $\mathcal{M}^G$  and  $(M(2, C) \otimes \mathcal{M})^G$  commute with  $\mathcal{M}^G$  so that the inclusion should be reducible for  $r = 4$ .

Note that  $G$  leaves both the elements of  $\mathcal{N}$  and  $\mathcal{M}$  invariant whereas  $SU(2)$  leaves the elements of  $\mathcal{N}$  invariant.  $M(2, C)$  is effectively replaced with the orbifold  $M(2, C)/G$ , with  $G$  acting as automorphisms. The space of these orbits has complex dimension  $d = 4$  for finite  $G$ .

For  $r < 4$  inclusion is defined as  $M^G \subset M$ . The representation of  $G$  as outer automorphism must change step by step in the inclusion sequence  $\dots \subset \mathcal{N} \subset \mathcal{M} \subset \dots$  since otherwise  $G$  would act trivially as one proceeds in the inclusion sequence. This is true since each step brings in additional finite-dimensional tensor factor in which  $G$  acts as automorphisms so that although  $\mathcal{M}$  can be invariant under  $G_{\mathcal{M}}$  it is not invariant under  $G_{\mathcal{N}}$ .

These two inclusions might accompany each other in TGD based physics. One could consider  $r < 4$  inclusion  $\mathcal{N} = \mathcal{M}^G \subset \mathcal{M}$  with  $G$  acting non-trivially in  $\mathcal{M}/\mathcal{N}$  quantum Clifford algebra.  $\mathcal{N}$  would decompose by  $r = 4$  inclusion to  $\mathcal{N}_1 \subset \mathcal{N}$  with  $SU(2)$  taking the role of  $G$ .  $\mathcal{N}/\mathcal{N}_1$  quantum Clifford algebra would transform non-trivially under  $SU(2)$  but would be  $G$  singlet.

In TGD framework the  $G$ -invariance for  $SU(2)$  representations means a reduction of  $S^2$  to the orbifold  $S^2/G$ . The coverings  $H_\pm \rightarrow H_\pm/G_a \times G_b$  should relate to these double inclusions and  $SU(2)$  inclusion could mean Kac-Moody type gauge symmetry for  $\mathcal{N}$ . Note that the presence of the factor

containing only unit matrix should relate directly to the generator  $d$  in the generator set of affine algebra in the McKay construction [?]. The physical interpretation of the fact that almost all ADE type extended diagrams ( $D_n^{(1)}$  must have  $n \geq 4$ ) are allowed for  $r = 4$  inclusions whereas  $D_{2n+1}$  and  $E_6$  are not allowed for  $r < 4$ , remains open.

### 13.10.3 Generalization from $SU(2)$ to arbitrary compact group

The inclusions with index  $\mathcal{M} : \mathcal{N} < 4$  have one-dimensional relative commutant  $\mathcal{N}' \cup \mathcal{M}$ . The most obvious conjecture that  $\mathcal{M} : \mathcal{N} \geq 4$  corresponds to a non-trivial relative commutant is wrong. The index for Jones inclusion is identifiable as the square of quantum dimension of the fundamental representation of  $SU(2)$ . This identification generalizes to an arbitrary representation of arbitrary compact Lie group.

In his thesis Wenzl [?] studied the representations of Hecke algebras  $H_n(q)$  of type  $A_n$  obtained from the defining relations of symmetric group by the replacement  $e_i^2 = (q-1)e_i + q$ .  $H_n$  is isomorphic to complex group algebra of  $S_n$  if  $q$  is not a root of unity and for  $q = 1$  the irreducible representations of  $H_n(q)$  reduce trivially to Young's representations of symmetric groups. For primitive roots of unity  $q = \exp(i2\pi/l)$ ,  $l = 4, 5, \dots$ , the representations of  $H_n(\infty)$  give rise to inclusions for which index corresponds to a quantum dimension of any irreducible representation of  $SU(k)$ ,  $k \geq 2$ . For  $SU(2)$  also the value  $l = 3$  is allowed for spin 1/2 representation.

The inclusions are obtained by dropping the first  $m$  generators  $e_k$  from  $H_\infty(q)$  and taking double commutant of both  $H_\infty$  and the resulting algebra. The relative commutant corresponds to  $H_m(q)$ . By reducing by the minimal projection to relative commutant one obtains an inclusion with a trivial relative commutant. These inclusions are analogous to a discrete states superposed in continuum. Thus the results of Jones generalize from the fundamental representation of  $SU(2)$  to all representations of all groups  $SU(k)$ , and in fact to those of general compact groups as it turns out.

The generalization of the formula for index to square of quantum dimension of an irreducible representation of  $SU(k)$  reads as

$$\mathcal{M} : \mathcal{N} = \prod_{1 \leq r < s \leq k} \frac{\sin^2((\lambda_r - \lambda_s + s - r)\pi/l)}{\sin^2((s - r)n/l)}. \quad (13.10.1)$$

Here  $\lambda_r$  is the number of boxes in the  $r^{\text{th}}$  row of the Yang diagram with  $n$  boxes characterizing the representations and the condition  $1 \leq k \leq l - 1$  holds true. Only Young diagrams satisfying the condition  $l - k = \lambda_1 - \lambda_{r_{\text{max}}}$  are allowed.

The result would allow to restrict the generalization of the imbedding space in such a manner that only cyclic group  $Z_n$  appears in the covering of  $M^4 \rightarrow M^4/G_a$  or  $CP_2 \rightarrow CP_2/G_b$  factor. Be as it may, it seems that quantum representations of any compact Lie group can be realized using the generalization of the imbedding space. In the case of  $SU(2)$  the interpretation of higher-dimensional quantum representations in terms of Connes tensor products of 2-dimensional fundamental representations is highly suggestive.

The groups  $SO(3, 1) \times SU(3)$  and  $SL(2, C) \times U(2)_{ew}$  have a distinguished position both in physics and quantum TGD and the vision about physics as a generalized number theory implies them. Also the general pattern for inclusions selects these groups, and one can say that the condition that all possible statistics are realized is guaranteed by the choice  $M^4 \times CP_2$ .

1.  $n > 2$  for the quantum counterparts of the fundamental representation of  $SU(2)$  means that braid statistics for Jones inclusions cannot give the usual fermionic statistics. That Fermi statistics cannot "emerge" conforms with the role of infinite- $D$  Clifford algebra as a canonical representation of HFF of type  $II_1$ .  $SO(3, 1)$  as isometries of  $H$  gives  $Z_2$  statistics via the action on spinors of  $M^4$  and  $U(2)$  holonomies for  $CP_2$  realize  $Z_2$  statistics in  $CP_2$  degrees of freedom.
2.  $n > 3$  for more general inclusions in turn excludes  $Z_3$  statistics as braid statistics in the general case.  $SU(3)$  as isometries induces a non-trivial  $Z_3$  action on quark spinors but trivial action at the imbedding space level so that  $Z_3$  statistics would be in question.

# Mathematics

- [A1] Gaussian Mersenne. <http://primes.utm.edu/glossary/xpage/GaussianMersenne.html>.
- [A2] Z. I. Borevich and I. R. Shafarevich. *Number Theory*. Academic Press, 1966.
- [A3] Eisenhart. *Riemannian Geometry*. Princeton University Press, 1964.
- [A4] C. N. Pope G. W. Gibbons.  $CP_2$  as gravitational instanton. *Comm. Math. Phys.*, 55, 1977.
- [A5] W. Hawking, S. and N. Pope, C. Generalized Spin Structures in Quantum Gravity. *Phys. Lett.*, (1), 1978.
- [A6] S. Helgason. *Differential Geometry and Symmetric Spaces*. Academic Press, New York, 1962.
- [A7] C. Itzykson and J-B. Zuber. *Quantum Field Theory*, volume 549. Mc Graw-Hill, New York, 1980.
- [A8] J. Milnor. *Topology form Differential Point of View*. The University Press of Virginia, Virginia, 1965.
- [A9] D. S. Moak. The q-analogue of the Laguerre polynomials. *J. Math. Anal. Appl.*, 81, 1981.
- [A10] N. Pope, C. Eigenfunctions and  $Spin^c$  Structures on  $CP_2$ , 1980.
- [A11] B. Shipman. The geometry of momentum mappings on generalized flag manifolds, connections with a dynamical system, quantum mechanics and the dance of honeybee. <http://math.cornell.edu/~oliver/Shipman.gif>, 1998.
- [A12] M. Spivak. *Differential Geometry I,II,III,IV*. Publish or Perish, Boston, 1970.
- [A13] J. Hanson T. Eguchi, B. Gilkey. *Phys. Rep.*, 66:1980, 1980.
- [A14] R. Thom. *Commentarii Math. Helvet.*, 28, 1954.
- [A15] Wallace. *Differential Topology*. W. A. Benjamin, New York, 1968.
- [A16] E. C. Zeeman. *Catastrophe Theory*. Addison-Wessley Publishing Company, 1977.



# Theoretical Physics

- [B1] J. Björken and S. Drell. *Relativistic Quantum Fields*. Mc Graw-Hill, New York, 1965.
- [B2] K. Huang. *Quarks, Leptons & Gauge Fields*. World Scientific, 1982.
- [B3] R. Kiehn. Electromagnetic waves in vacuum with torsion and spin. <http://www22.pair.com/csdc/pdf/helical6.pdf>.
- [B4] G. Parisi. *Field Theory, Disorder and Simulations*. World Scientific, 1992.
- [B5] A. Zee. *The Unity of Forces in the Universe*. World Science Press, Singapore, 1982.



# Particle and Nuclear Physics

- [C1] Giant Dipole Resonance: What is Known About? <http://cdfc.sinp.msu.ru/publications/lshkhnv-ELI03.pdf>.
- [C2] Abragam A. *The principles of nuclear magnetism*. Clarendon Press, Oxford, 1961.
- [C3] C. Rolfs et al. First hints on a change of the  $^{22}\text{Na}$  beta decay half-life in the metal Pd. *Eur. Phys. J. A*, 28, 2006.
- [C4] C. Rolfs et al. High-Z electron screening, the cases  $^{50}\text{V}(\text{p},\text{n})^{50}$ . *Eur. Phys. J. A*, 28, 2006.
- [C5] G. Tertuchny et al. Microscopic description of the pygmy and giant electric dipole resonances in stable Ca isotopes. <http://arxiv.org/abs/nucl-th/0603/0603051>, 2006.
- [C6] S. E. Shnoll et al. Realization of discrete states during fluctuations in macroscopic processes. *Uspekhi Fisicheskikh Nauk*, 41(10):1025–1035, 1998.
- [C7] V. M. Lobashev et al. In *Neutrino 96*, Singapore, 1996. World Scientific.
- [C8] K. Langanke H. J. Assenbaum and C. Rolfs. *Z. Phys. A*, 327, 1987.
- [C9] A. D. Krisch. The spin of proton. *Scientific American*, May 1979.
- [C10] M. T. Ressel and M. S. Turner. *Astrophys.*, 14, 1990.
- [C11] C. Rolfs and W. S. Rodney. *Cauldrons in the Cosmos*. University of Chicago Press, Chicago, 1988.





# Condensed Matter Physics

- [D1] Fractional quantum Hall Effect. [http://en.wikipedia.org/wiki/Fractional\\_quantum\\_Hall\\_effect](http://en.wikipedia.org/wiki/Fractional_quantum_Hall_effect).
- [D2] Hydrogen bonds. [http://en.wikipedia.org/wiki/Hydrogen\\_bond](http://en.wikipedia.org/wiki/Hydrogen_bond).
- [D3] Phase conjugation. <http://www.usc.edu/dept/ee/People/Faculty/feinberg.html>.
- [D4] O. Balcou and L. Durtriaux. *Phys. Rev.*, 78, 1997.
- [D5] J. K. Borhardt. The chemical formula H<sub>2</sub>O - a misnomer. *The Alchemist*, August 2003.
- [D6] M. Chaplin. Water Structure and Behavior. <http://www.lsbu.ac.uk/water/index.html>, 2005.
- [D7] R. Y. Chiao. Super-conductors as transducers and antennas for gravitational and electromagnetic radiation. <http://arxiv.org/abs/gr-gc/0204012>.
- [D8] R. Y. Chiao. Tunnelling Times and Super-luminality: a Tutorial, November 1998.
- [D9] R. Y. Chiao and A. M. Steinberg. In E. Wolf, editor, *Progress in Optics XXXVII*, volume 345, Amsterdam, 1997. Elsevier.
- [D10] R. A. Cowley. Neutron-scattering experiments and quantum entanglement. *Physica B*, 350:243–245, 2004.
- [D11] D. J. Evans et al. Experimental Demonstration of Violations of the Second Law of Thermodynamics for Small Systems and Short Time Scales. *Phys. Rev.*, 89, 2002.
- [D12] G. A. Melkov et al. *Phase Conjugation of Linear and Nonlinear Signals of Magnetostatic Waves*. Trans Tech Publications, Switzerland, 2001.
- [D13] G. Nimtz et al. *J. Phys.*, 4, 1994.
- [D14] J. B. Miller et al. Fractional Quantum Hall effect in a quantum point contact at filling fraction  $5/2$ . <http://arxiv.org/abs/cond-mat/0703161v2>, 2007.
- [D15] R. Mills et al. Spectroscopic and NMR identification of novel hybrid ions in fractional quantum energy states formed by an exothermic reaction of atomic hydrogen with certain catalysts. <http://www.blacklightpower.com/techpapers.html>, 2003.
- [D16] S. M. Girvin. Quantum Hall Effect, Novel Excitations and Broken Symmetries. <http://arxiv.org/abs/cond-mat/9907002>, 1999.
- [D17] J.K. Jain. *Phys. Rev.*, 63, 1989.
- [D18] P. Kanarev. Water is New Source of Energy. *Krasnodar*, 2002.
- [D19] P. Kanarev and T. Mizuno. Cold fusion by plasma electrolysis of water. <http://www.guns.connect.fi/innoplaza/energy/story/Kanarev/codlfusion/>, 2002.
- [D20] I. Langmuir. *Journal of American Chemical Society*, 37, 1915.
- [D21] R. B. Laughlin. *Phys. Rev.*, 50, 1990.

- [D22] J-C. Li and D.K. Ross. Evidence of Two Kinds of Hydrogen Bonds in Ices. *Nature*, 365:327–329, 1993.
- [D23] R. Mackenzie and F. Wilczek. *Rev. Mod. Phys. A*, 3:2827, 1988.
- [D24] S. Meyer. Water Fuel Cell. International News Release, No. 11 A-Rv., 1996.
- [D25] D. M. Pepper. Nonlinear Optical Phase Conjugation. *Optical Engineering*, 21(2), March 1982.
- [D26] H. Puthoff. Ground State of Hydrogen as a Zero-Point Fluctuation Determined State. *Phys. Rev. D*, 35, 1987.
- [D27] Y. Danon R. Moreh, R. C. Block and M. Neumann. Search for anomalous scattering of keV neutrons from H<sub>2</sub>O-D<sub>2</sub>O mixtures. *Phys. Rev.*, 94, 2005.
- [D28] V. V. Shkunov and B. Ya. Zeldovich. Optical Phase Conjugation. *Scientific American*, 1985.
- [D29] D. D. Stancil. *Theory of Magnetostatic Waves*. Springer Verlag, 1993.
- [D30] A. M. Steinberg and R. Y. Chiao. Sub-femtosecond determination of transmission delay times for a dielectric mirror (photonic bandgap) as a function of angle of incidence. <http://arxiv.org/abs/quant-ph/9501013>, 1995.
- [D31] L. Wang. *Nature*, July 2000.
- [D32] Pollack G. Zheng, Jian-ming. Long-range forces extending from polymer-gel surfaces. <http://arxiv.org/abs/cond-mat/0305093>, 2003.

# Neuroscience and Consciousness

- [J1] Visual short term memory. [http://en.wikipedia.org/wiki/Visual\\_short-term\\_memory](http://en.wikipedia.org/wiki/Visual_short-term_memory).
- [J2] Frontal lobes. [http://en.wikipedia.org/wiki/Frontal\\_lobes](http://en.wikipedia.org/wiki/Frontal_lobes).
- [J3] Goldman equation. [http://en.wikipedia.org/wiki/Goldman\\_equation](http://en.wikipedia.org/wiki/Goldman_equation).
- [J4] Limbic system. [http://en.wikipedia.org/wiki/Limbic\\_system](http://en.wikipedia.org/wiki/Limbic_system).
- [J5] A method of changing biological object's hereditary signs and a device for biological information directed transfer. Patent N1828665. Application N3434801, invention priority as of 30.12.1981, registered 13.10.1992.
- [J6] Short term memory. [http://en.wikipedia.org/wiki/Short\\_term\\_memory](http://en.wikipedia.org/wiki/Short_term_memory).
- [J7] D. J. Benor. *Spiritual Healing: scientific validation of a healing revolution Vol. I*. Vision publications, Southfield MI, 2001.
- [J8] D. J. Bierman and D. I. Radin. Anomalous Anticipatory Response on Randomized Future Conditions. *Perceptual and Motor Skills*, 84:689–690, 1997.
- [J9] C. F. Blackman. *Effect of Electrical and Magnetic Fields on the Nervous System*, pages 331–355. Plenum, New York, 1994.
- [J10] V. Chernobrov. Experiments on the Change of Direction and Rate of Time Motion. In *Proc. of III Int. Conf. On Problems of Space, Time, and Gravitation. Russian Academy of Sciences, St. Petersburg, Russia*, 1996.
- [J11] U. Di Corpo. The conflict between entropy and syntropy: the vital needs model. 2007.
- [J12] B. Libet et al. Subjective referral of the timing for a conscious sensory experience. *Brain*, 102, 1979.
- [J13] L. Fantappie. *Teoria Unitaria del Mondo Fisico e Biologico*. Di Renzo Editore, Roma, 1942.
- [J14] M. Germiné. Scientific Validation of Planetary Consciousness. *Journal of Non-Locality and Remote Mental Interactions*. <http://www.emergentmind.org/germineI3.htm>, 1(3), 2002.
- [J15] A. M'Chirgui M. Ben Salem M. Sakly H. Abdelmeik, S. Amara. Impact of evolution on the electrical properties of sciatic nerves: super-conductivity-like. *Journal of Physical & Chemical News*, 2003.
- [J16] S. Klein. Libet's Research on Timing of Conscious Intention to Act: A Commentary. *Consciousness and Cognition*. [http://cornea.berkeley.edu/pubs/ccog\\_2002\\_0580-Klein-Commentary.pdf](http://cornea.berkeley.edu/pubs/ccog_2002_0580-Klein-Commentary.pdf), 11, 2002.
- [J17] B. Libet. Readiness potentials preceding unrestricted spontaneous and preplanned voluntary acts. [http://cornea.berkeley.edu/pubs/ccog\\_2002\\_0580-Klein-Commentary.pdf](http://cornea.berkeley.edu/pubs/ccog_2002_0580-Klein-Commentary.pdf), 1982.
- [J18] J. McMoneagle. *Remote Viewing Secrets*. Hampton Roads Publishing Company, Inc., 2000.
- [J19] Kozyrev N.A. *Prichinnaya ili nesimmetrichnaya mekhanika v lineinom priblizhenii*. GAO AN SSSR, Pulkovo, 1958.

- [J20] P. L. Nunez. Toward a Quantitative Description of Large Scale Neocortical Dynamic Function and EEG. *Behavioral and Brain Sciences*, 23, 2000.
- [J21] M. Persinger. The tectonic strain theory as an explanation for UFO phenomena. <http://www.laurentian.ca/www/neurosci/tectonicedit.htm>, 1999.
- [J22] D. Reed. Conceptual Hurdles to New Millennium Physics. *Explore!*, (1), 2003.
- [J23] J. S. Nicholis S. W. Kuffler and A. R. Martin. *From Neuron to Brain*. Sinauer, Massachusetts, 1984.
- [J24] W. A. Tiller. Towards a Quantitative Science and Technology that Includes Human Consciousness. *Vision-In-Action*. <http://www.via-visioninaction.org>, 4, 2003.
- [J25] W. A. Tiller and W. E. Dibble Jr. New experimental data revealing an unexpected dimension to materials science and engineering. *Mat. Res. Innovat.*, 5:21–34, 2001.
- [J26] W. A. Tiller and W. E. Dibble Jr. Anomalous Temperature Oscillation Behavior Near a Source in a "Conditioned" Space: part I, The Spatial Variation. <http://tillerfoundation.com/newpapers.htm>, 2002.
- [J27] A. Vannini. Advanced Waves, Retrocausality, and Consciousness. 2007.
- [J28] W. E. Dibble Jr. W. A. Tiller and M. J. Kohane. *Conscious Acts of Creation: the Emergence of a New Physics*, volume 17. Pavior Publishing, 2001.
- [J29] L. Day (with G. DelaWarr). *New Worlds Beyond the Atom*. Vincent Stuart Publishers Ltd., London, 1956.

# Books related to TGD

- [K1] M. Pitkänen. 1983.
- [K2] M. Pitkänen. Is it Possible to Understand Coupling Constant Evolution at Space-Time Level? In *Towards M-Matrix*. Onlinebook. [http://tgdtheory.com/public\\_html/tgdquant/tgdquant.html#rgflow](http://tgdtheory.com/public_html/tgdquant/tgdquant.html#rgflow), 2006.
- [K3] M. Pitkänen. About Strange Effects Related to Rotating Magnetic Systems . In *TGD and Fringe Physics*. Onlinebook. [http://tgdtheory.com/public\\_html/freenergy/freenergy.html#Faraday](http://tgdtheory.com/public_html/freenergy/freenergy.html#Faraday), 2006.
- [K4] M. Pitkänen. About the New Physics Behind Qualia. In *Quantum Hardware of Living Matter*. Onlinebook. [http://tgdtheory.com/public\\_html/bioware/bioware.html#newphys](http://tgdtheory.com/public_html/bioware/bioware.html#newphys), 2006.
- [K5] M. Pitkänen. An Overview about Quantum TGD: Part I. In *Topological Geometrodynamics: Overview*. Onlinebook. [http://tgdtheory.com/public\\_html/tgdview/tgdview.html#evoII](http://tgdtheory.com/public_html/tgdview/tgdview.html#evoII), 2006.
- [K6] M. Pitkänen. An Overview about the Evolution of Quantum TGD. In *Topological Geometrodynamics: Overview*. Onlinebook. [http://tgdtheory.com/public\\_html/tgdview/tgdview.html#evoI](http://tgdtheory.com/public_html/tgdview/tgdview.html#evoI), 2006.
- [K7] M. Pitkänen. Anomalies Related to the Classical  $Z^0$  Force and Gravitation. In *TGD and Fringe Physics*. Onlinebook. [http://tgdtheory.com/public\\_html/freenergy/freenergy.html#Zanom](http://tgdtheory.com/public_html/freenergy/freenergy.html#Zanom), 2006.
- [K8] M. Pitkänen. Appendix A: Quantum Groups and Related Structures. In *Towards M-Matrix*. Onlinebook. [http://tgdtheory.com/public\\_html/tgdquant/tgdquant.html#bialgebra](http://tgdtheory.com/public_html/tgdquant/tgdquant.html#bialgebra), 2006.
- [K9] M. Pitkänen. Basic Extremals of Kähler Action. In *Physics in Many-Sheeted Space-Time*. Onlinebook. [http://tgdtheory.com/public\\_html/tgdclass/tgdclass.html#class](http://tgdtheory.com/public_html/tgdclass/tgdclass.html#class), 2006.
- [K10] M. Pitkänen. *Bio-Systems as Conscious Holograms*. Onlinebook. [http://tgdtheory.com/public\\_html/hologram/hologram.html](http://tgdtheory.com/public_html/hologram/hologram.html), 2006.
- [K11] M. Pitkänen. Bio-Systems as Conscious Holograms. In *Bio-Systems as Conscious Holograms*. Onlinebook. [http://tgdtheory.com/public\\_html/hologram/hologram.html#hologram](http://tgdtheory.com/public_html/hologram/hologram.html#hologram), 2006.
- [K12] M. Pitkänen. *Bio-Systems as Self-Organizing Quantum Systems*. Onlinebook. [http://tgdtheory.com/public\\_html/bioselforg/bioselforg.html](http://tgdtheory.com/public_html/bioselforg/bioselforg.html), 2006.
- [K13] M. Pitkänen. Bio-Systems as Super-Conductors: part I. In *Quantum Hardware of Living Matter*. Onlinebook. [http://tgdtheory.com/public\\_html/bioware/bioware.html#superc1](http://tgdtheory.com/public_html/bioware/bioware.html#superc1), 2006.
- [K14] M. Pitkänen. Bio-Systems as Super-Conductors: part II. In *Quantum Hardware of Living Matter*. Onlinebook. [http://tgdtheory.com/public\\_html/bioware/bioware.html#superc2](http://tgdtheory.com/public_html/bioware/bioware.html#superc2), 2006.
- [K15] M. Pitkänen. Configuration Space Spinor Structure. In *Quantum Physics as Infinite-Dimensional Geometry*. Onlinebook. [http://tgdtheory.com/public\\_html/tgdgeom/tgdgeom.html#cspin](http://tgdtheory.com/public_html/tgdgeom/tgdgeom.html#cspin), 2006.

- [K16] M. Pitkänen. Construction of elementary particle vacuum functionals. In *p-Adic Length Scale Hypothesis and Dark Matter Hierarchy*. Onlinebook. [http://tgdtheory.com/public\\_html/paddark/paddark.html#elvafu](http://tgdtheory.com/public_html/paddark/paddark.html#elvafu), 2006.
- [K17] M. Pitkänen. Construction of Quantum Theory: M-matrix. In *Towards M-Matrix*. Onlinebook. [http://tgdtheory.com/public\\_html/tgdquant/tgdquant.html#towards](http://tgdtheory.com/public_html/tgdquant/tgdquant.html#towards), 2006.
- [K18] M. Pitkänen. Cosmic Strings. In *Physics in Many-Sheeted Space-Time*. Onlinebook. [http://tgdtheory.com/public\\_html/tgdclass/tgdclass.html#cstrings](http://tgdtheory.com/public_html/tgdclass/tgdclass.html#cstrings), 2006.
- [K19] M. Pitkänen. Crop Circles and Life at Parallel Space-Time Sheets. In *Magnetospheric Consciousness*. Onlinebook. [http://tgdtheory.com/public\\_html/magnconsc/magnconsc.html#crop1](http://tgdtheory.com/public_html/magnconsc/magnconsc.html#crop1), 2006.
- [K20] M. Pitkänen. Crop Circles and Life at Parallel Space-Time Sheets. In *Magnetospheric Consciousness*. Onlinebook. [http://tgdtheory.com/public\\_html/magnconsc/magnconsc.html#crop2](http://tgdtheory.com/public_html/magnconsc/magnconsc.html#crop2), 2006.
- [K21] M. Pitkänen. Dark Forces and Living Matter. In *p-Adic Length Scale Hypothesis and Dark Matter Hierarchy*. Onlinebook. [http://tgdtheory.com/public\\_html/paddark/paddark.html#darkforces](http://tgdtheory.com/public_html/paddark/paddark.html#darkforces), 2006.
- [K22] M. Pitkänen. Dark Matter Hierarchy and Hierarchy of EEGs. In *TGD and EEG*. Onlinebook. [http://tgdtheory.com/public\\_html/tgdeeg/tgdeeg.html#eegdark](http://tgdtheory.com/public_html/tgdeeg/tgdeeg.html#eegdark), 2006.
- [K23] M. Pitkänen. Dark Nuclear Physics and Condensed Matter. In *p-Adic Length Scale Hypothesis and Dark Matter Hierarchy*. Onlinebook. [http://tgdtheory.com/public\\_html/paddark/paddark.html#exonuclear](http://tgdtheory.com/public_html/paddark/paddark.html#exonuclear), 2006.
- [K24] M. Pitkänen. DNA as Topological Quantum Computer. In *Genes and Memes*. Onlinebook. [http://tgdtheory.com/public\\_html/genememe/genememe.html#dnatqc](http://tgdtheory.com/public_html/genememe/genememe.html#dnatqc), 2006.
- [K25] M. Pitkänen. Does TGD Predict the Spectrum of Planck Constants? In *Towards M-Matrix*. Onlinebook. [http://tgdtheory.com/public\\_html/tgdquant/tgdquant.html#Planck](http://tgdtheory.com/public_html/tgdquant/tgdquant.html#Planck), 2006.
- [K26] M. Pitkänen. Evolution in Many-Sheeted Space-Time. In *Genes and Memes*. Onlinebook. [http://tgdtheory.com/public\\_html/genememe/genememe.html#prebio](http://tgdtheory.com/public_html/genememe/genememe.html#prebio), 2006.
- [K27] M. Pitkänen. General Ideas about Many-Sheeted Space-Time: Part I. In *Physics in Many-Sheeted Space-Time*. Onlinebook. [http://tgdtheory.com/public\\_html/tgdclass/tgdclass.html#topcond](http://tgdtheory.com/public_html/tgdclass/tgdclass.html#topcond), 2006.
- [K28] M. Pitkänen. General Theory of Qualia. In *Bio-Systems as Conscious Holograms*. Onlinebook. [http://tgdtheory.com/public\\_html/hologram/hologram.html#qualia](http://tgdtheory.com/public_html/hologram/hologram.html#qualia), 2006.
- [K29] M. Pitkänen. *Genes and Memes*. Onlinebook. [http://tgdtheory.com/public\\_html/genememe/genememe.html](http://tgdtheory.com/public_html/genememe/genememe.html), 2006.
- [K30] M. Pitkänen. Genes and Memes. In *Genes and Memes*. Onlinebook. [http://tgdtheory.com/public\\_html/genememe/genememe.html#genememec](http://tgdtheory.com/public_html/genememe/genememe.html#genememec), 2006.
- [K31] M. Pitkänen. Homeopathy in Many-Sheeted Space-Time. In *Bio-Systems as Conscious Holograms*. Onlinebook. [http://tgdtheory.com/public\\_html/hologram/hologram.html#homeoc](http://tgdtheory.com/public_html/hologram/hologram.html#homeoc), 2006.
- [K32] M. Pitkänen. Macro-Temporal Quantum Coherence and Spin Glass Degeneracy. In *Bio-Systems as Conscious Holograms*. Onlinebook. [http://tgdtheory.com/public\\_html/hologram/hologram.html#macro](http://tgdtheory.com/public_html/hologram/hologram.html#macro), 2006.
- [K33] M. Pitkänen. Macroscopic Quantum Coherence and Quantum Metabolism as Different Sides of the Same Coin. In *Bio-Systems as Conscious Holograms*. Onlinebook. [http://tgdtheory.com/public\\_html/hologram/hologram.html#metab](http://tgdtheory.com/public_html/hologram/hologram.html#metab), 2006.

- [K34] M. Pitkänen. Macroscopic Quantum Phenomena and  $CP_2$  Geometry. In *Physics in Many-Sheeted Space-Time*. Onlinebook. [http://tgdtheory.com/public\\_html/tgdclass/tgdclass.html#super](http://tgdtheory.com/public_html/tgdclass/tgdclass.html#super), 2006.
- [K35] M. Pitkänen. Magnetic Sensory Canvas Hypothesis. In *TGD and EEG*. Onlinebook. [http://tgdtheory.com/public\\_html//tgdeeg/tgdeeg/tgdeeg.html#mec](http://tgdtheory.com/public_html//tgdeeg/tgdeeg/tgdeeg.html#mec), 2006.
- [K36] M. Pitkänen. *Magnetospheric Consciousness*. Onlinebook. [http://tgdtheory.com/public\\_html/magnconsc/magnconsc.html](http://tgdtheory.com/public_html/magnconsc/magnconsc.html), 2006.
- [K37] M. Pitkänen. Magnetospheric Sensory Representations. In *Magnetospheric Consciousness*. Onlinebook. [http://tgdtheory.com/public\\_html/magnconsc/magnconsc.html#srepres](http://tgdtheory.com/public_html/magnconsc/magnconsc.html#srepres), 2006.
- [K38] M. Pitkänen. Many-Sheeted DNA. In *Genes and Memes*. Onlinebook. [http://tgdtheory.com/public\\_html/genememe/genememe.html#genecodec](http://tgdtheory.com/public_html/genememe/genememe.html#genecodec), 2006.
- [K39] M. Pitkänen. Massless states and particle massivation. In *p-Adic Length Scale Hypothesis and Dark Matter Hierarchy*. Onlinebook. [http://tgdtheory.com/public\\_html/paddark/paddark.html#mless](http://tgdtheory.com/public_html/paddark/paddark.html#mless), 2006.
- [K40] M. Pitkänen. *Mathematical Aspects of Consciousness Theory*. Onlinebook. [http://tgdtheory.com/public\\_html/mathconsc/mathconsc.html](http://tgdtheory.com/public_html/mathconsc/mathconsc.html), 2006.
- [K41] M. Pitkänen. Matter, Mind, Quantum. In *TGD Inspired Theory of Consciousness*. Onlinebook. [http://tgdtheory.com/public\\_html/tgdconsc/tgdconsc.html#conscic](http://tgdtheory.com/public_html/tgdconsc/tgdconsc.html#conscic), 2006.
- [K42] M. Pitkänen. Negentropy Maximization Principle. In *TGD Inspired Theory of Consciousness*. Onlinebook. [http://tgdtheory.com/public\\_html/tgdconsc/tgdconsc.html#nmpc](http://tgdtheory.com/public_html/tgdconsc/tgdconsc.html#nmpc), 2006.
- [K43] M. Pitkänen. New Particle Physics Predicted by TGD: Part I. In *p-Adic Length Scale Hypothesis and Dark Matter Hierarchy*. Onlinebook. [http://tgdtheory.com/public\\_html/paddark/paddark.html#mass4](http://tgdtheory.com/public_html/paddark/paddark.html#mass4), 2006.
- [K44] M. Pitkänen. Nuclear String Hypothesis. In *p-Adic Length Scale Hypothesis and Dark Matter Hierarchy*. Onlinebook. [http://tgdtheory.com/public\\_html/paddark/paddark.html#nuclstring](http://tgdtheory.com/public_html/paddark/paddark.html#nuclstring), 2006.
- [K45] M. Pitkänen. *p-Adic length Scale Hypothesis and Dark Matter Hierarchy*. Onlinebook. [http://tgdtheory.com/public\\_html/paddark/paddark.html](http://tgdtheory.com/public_html/paddark/paddark.html), 2006.
- [K46] M. Pitkänen. p-Adic Particle Massivation: Hadron Masses. In *p-Adic Length Scale Hypothesis and Dark Matter Hierarchy*. Onlinebook. [http://tgdtheory.com/public\\_html/paddark/paddark.html#mass3](http://tgdtheory.com/public_html/paddark/paddark.html#mass3), 2006.
- [K47] M. Pitkänen. p-Adic Physics as Physics of Cognition and Intention. In *TGD Inspired Theory of Consciousness*. Onlinebook. [http://tgdtheory.com/public\\_html/tgdconsc/tgdconsc.html#cognic](http://tgdtheory.com/public_html/tgdconsc/tgdconsc.html#cognic), 2006.
- [K48] M. Pitkänen. *Physics in Many-Sheeted Space-Time*. Onlinebook. [http://tgdtheory.com/public\\_html/tgdclass/tgdclass.html](http://tgdtheory.com/public_html/tgdclass/tgdclass.html), 2006.
- [K49] M. Pitkänen. Quantum Antenna Hypothesis. In *Quantum Hardware of Living Matter*. Onlinebook. [http://tgdtheory.com/public\\_html/bioware/bioware.html#tubuc](http://tgdtheory.com/public_html/bioware/bioware.html#tubuc), 2006.
- [K50] M. Pitkänen. Quantum Astrophysics. In *Physics in Many-Sheeted Space-Time*. Onlinebook. [http://tgdtheory.com/public\\_html/tgdclass/tgdclass.html#qastro](http://tgdtheory.com/public_html/tgdclass/tgdclass.html#qastro), 2006.
- [K51] M. Pitkänen. Quantum Control and Coordination in Bio-systems: Part I. In *Bio-Systems as Self-Organizing Quantum Systems*. Onlinebook. [http://tgdtheory.com/public\\_html/bioselforg/bioselforg.html#qcococI](http://tgdtheory.com/public_html/bioselforg/bioselforg.html#qcococI), 2006.
- [K52] M. Pitkänen. Quantum Control and Coordination in Bio-Systems: Part II. In *Bio-Systems as Self-Organizing Quantum Systems*. Onlinebook. [http://tgdtheory.com/public\\_html/bioselforg/bioselforg.html#qcococII](http://tgdtheory.com/public_html/bioselforg/bioselforg.html#qcococII), 2006.

- [K53] M. Pitkänen. *Quantum Hardware of Living Matter*. Onlinebook. [http://tgdtheory.com/public\\_html/bioware/bioware.html](http://tgdtheory.com/public_html/bioware/bioware.html), 2006.
- [K54] M. Pitkänen. Quantum Model for Hearing. In *TGD and EEG*. Onlinebook. [http://tgdtheory.com/public\\_html//tgdeeg/tgdeeg/tgdeeg.html#hearing](http://tgdtheory.com/public_html//tgdeeg/tgdeeg/tgdeeg.html#hearing), 2006.
- [K55] M. Pitkänen. Quantum Model for Nerve Pulse. In *TGD and EEG*. Onlinebook. [http://tgdtheory.com/public\\_html//tgdeeg/tgdeeg/tgdeeg.html#pulse](http://tgdtheory.com/public_html//tgdeeg/tgdeeg/tgdeeg.html#pulse), 2006.
- [K56] M. Pitkänen. Quantum Model for Paranormal Phenomena. In *TGD Inspired Theory of Consciousness*. Onlinebook. [http://tgdtheory.com/public\\_html/tgdconsc/tgdconsc.html#parac](http://tgdtheory.com/public_html/tgdconsc/tgdconsc.html#parac), 2006.
- [K57] M. Pitkänen. Quantum Model for Sensory Representations. In *TGD Inspired Theory of Consciousness*. Onlinebook. [http://tgdtheory.com/public\\_html/tgdconsc/tgdconsc.html#expc](http://tgdtheory.com/public_html/tgdconsc/tgdconsc.html#expc), 2006.
- [K58] M. Pitkänen. Quantum Model of EEG. In *TGD and EEG*. Onlinebook. [http://tgdtheory.com/public\\_html/tgdeeg/tgdeeg.html#eegII](http://tgdtheory.com/public_html/tgdeeg/tgdeeg.html#eegII), 2006.
- [K59] M. Pitkänen. Quantum Model of Memory. In *TGD Inspired Theory of Consciousness*. Onlinebook. [http://tgdtheory.com/public\\_html/tgdconsc/tgdconsc.html#memoryc](http://tgdtheory.com/public_html/tgdconsc/tgdconsc.html#memoryc), 2006.
- [K60] M. Pitkänen. *Quantum Physics as Infinite-Dimensional Geometry*. Onlinebook. [http://tgdtheory.com/public\\_html/tgdgeom/tgdgeom.html](http://tgdtheory.com/public_html/tgdgeom/tgdgeom.html), 2006.
- [K61] M. Pitkänen. *Quantum TGD*. Onlinebook. [http://tgdtheory.com/public\\_html/tgdquant/tgdquant.html](http://tgdtheory.com/public_html/tgdquant/tgdquant.html), 2006.
- [K62] M. Pitkänen. Quantum Theory of Self-Organization. In *Bio-Systems as Self-Organizing Quantum Systems*. Onlinebook. [http://tgdtheory.com/public\\_html/bioselforg/bioselforg.html#selforgac](http://tgdtheory.com/public_html/bioselforg/bioselforg.html#selforgac), 2006.
- [K63] M. Pitkänen. Semi-trance, Mental Illness, and Altered States of Consciousness. In *Magnetospheric Consciousness*. Onlinebook. [http://tgdtheory.com/public\\_html/magnconsc/magnconsc.html#semitrancec](http://tgdtheory.com/public_html/magnconsc/magnconsc.html#semitrancec), 2006.
- [K64] M. Pitkänen. Semitrance, Language, and Development of Civilization. In *Magnetospheric Consciousness*. Onlinebook. [http://tgdtheory.com/public\\_html/magnconsc/magnconsc.html#langsoc](http://tgdtheory.com/public_html/magnconsc/magnconsc.html#langsoc), 2006.
- [K65] M. Pitkänen. TGD and Astrophysics. In *Physics in Many-Sheeted Space-Time*. Onlinebook. [http://tgdtheory.com/public\\_html/tgdclass/tgdclass.html#astro](http://tgdtheory.com/public_html/tgdclass/tgdclass.html#astro), 2006.
- [K66] M. Pitkänen. TGD and Cosmology. In *Physics in Many-Sheeted Space-Time*. Onlinebook. [http://tgdtheory.com/public\\_html/tgdclass/tgdclass.html#cosmo](http://tgdtheory.com/public_html/tgdclass/tgdclass.html#cosmo), 2006.
- [K67] M. Pitkänen. *TGD and EEG*. Onlinebook. [http://tgdtheory.com/public\\_html/tgdeeg/tgdeeg.html](http://tgdtheory.com/public_html/tgdeeg/tgdeeg.html), 2006.
- [K68] M. Pitkänen. *TGD and Fringe Physics*. Onlinebook. [http://tgdtheory.com/public\\_html/freenergy/freenergy.html](http://tgdtheory.com/public_html/freenergy/freenergy.html), 2006.
- [K69] M. Pitkänen. TGD and Nuclear Physics. In *p-Adic Length Scale Hypothesis and Dark Matter Hierarchy*. Onlinebook. [http://tgdtheory.com/public\\_html/paddark/paddark.html#padnucl](http://tgdtheory.com/public_html/paddark/paddark.html#padnucl), 2006.
- [K70] M. Pitkänen. *TGD as a Generalized Number Theory*. Onlinebook. [http://tgdtheory.com/public\\_html/tgdnumber/tgdnumber.html](http://tgdtheory.com/public_html/tgdnumber/tgdnumber.html), 2006.
- [K71] M. Pitkänen. TGD as a Generalized Number Theory: p-Adicization Program. In *TGD as a Generalized Number Theory*. Onlinebook. [http://tgdtheory.com/public\\_html/tgdnumber/tgdnumber.html#visiona](http://tgdtheory.com/public_html/tgdnumber/tgdnumber.html#visiona), 2006.



- [K72] M. Pitkänen. TGD as a Generalized Number Theory: Quaternions, Octonions, and their Hyper Counterparts. In *TGD as a Generalized Number Theory*. Onlinebook. [http://tgdtheory.com/public\\_html/tgdnumber/tgdnumber.html#visionb](http://tgdtheory.com/public_html/tgdnumber/tgdnumber.html#visionb), 2006.
- [K73] M. Pitkänen. TGD Based Model for OBEs. In *TGD Inspired Theory of Consciousness*. Onlinebook. [http://tgdtheory.com/public\\_html/tgdconsc/tgdconsc.html#OBE](http://tgdtheory.com/public_html/tgdconsc/tgdconsc.html#OBE), 2006.
- [K74] M. Pitkänen. *TGD Inspired Theory of Consciousness*. Onlinebook. [http://tgdtheory.com/public\\_html/tgdconsc/tgdconsc.html](http://tgdtheory.com/public_html/tgdconsc/tgdconsc.html), 2006.
- [K75] M. Pitkänen. TGD Inspired Theory of Consciousness. In *Topological Geometrodynamics: Overview*. Onlinebook. [http://tgdtheory.com/public\\_html/tgdview/tgdview.html#tgdconsc2010](http://tgdtheory.com/public_html/tgdview/tgdview.html#tgdconsc2010), 2006.
- [K76] M. Pitkänen. The Notion of Free Energy and Many-Sheeted Space-Time Concept. In *TGD and Fringe Physics*. Onlinebook. [http://tgdtheory.com/public\\_html/freenergy/freenergy.html#freenergy](http://tgdtheory.com/public_html/freenergy/freenergy.html#freenergy), 2006.
- [K77] M. Pitkänen. The Relationship Between TGD and GRT. In *Physics in Many-Sheeted Space-Time*. Onlinebook. [http://tgdtheory.com/public\\_html/tgdclass/tgdclass.html#tgdgrt](http://tgdtheory.com/public_html/tgdclass/tgdclass.html#tgdgrt), 2006.
- [K78] M. Pitkänen. Three new physics realizations of the genetic code and the role of dark matter in bio-systems. In *Genes and Memes*. Onlinebook. [http://tgdtheory.com/public\\_html/genememe/genememe.html#dnatqccodes](http://tgdtheory.com/public_html/genememe/genememe.html#dnatqccodes), 2006.
- [K79] M. Pitkänen. Time, Spacetime and Consciousness. In *Bio-Systems as Conscious Holograms*. Onlinebook. [http://tgdtheory.com/public\\_html/hologram/hologram.html#time](http://tgdtheory.com/public_html/hologram/hologram.html#time), 2006.
- [K80] M. Pitkänen. *Topological Geometrodynamics: an Overview*. Onlinebook. [http://tgdtheory.com/public\\_html/tgdview/tgdview.html](http://tgdtheory.com/public_html/tgdview/tgdview.html), 2006.
- [K81] M. Pitkänen. Topological Quantum Computation in TGD Universe. In *Genes and Memes*. Onlinebook. [http://tgdtheory.com/public\\_html/genememe/genememe.html#tqc](http://tgdtheory.com/public_html/genememe/genememe.html#tqc), 2006.
- [K82] M. Pitkänen. Was von Neumann Right After All. In *Towards M-Matrix*. Onlinebook. [http://tgdtheory.com/public\\_html/tgdquant/tgdquant.html#vNeumann](http://tgdtheory.com/public_html/tgdquant/tgdquant.html#vNeumann), 2006.
- [K83] M. Pitkänen. Wormhole Magnetic Fields. In *Quantum Hardware of Living Matter*. Onlinebook. [http://tgdtheory.com/public\\_html/bioware/bioware.html#wormc](http://tgdtheory.com/public_html/bioware/bioware.html#wormc), 2006.



## Chapter 14

# Does TGD Predict Spectrum of Planck Constants?

### 14.1 Introduction

The quantization of Planck constant has been the basic theme of TGD since 2005 and the perspective in the earlier version of this chapter reflected the situation for about year and one half after the basic idea stimulated by the finding of Nottale [E23] that planetary orbits could be seen as Bohr orbits with enormous value of Planck constant given by  $\hbar_{gr} = GM_1M_2/v_0$ ,  $v_0 \simeq 2^{-11}$  for the inner planets. The general form of  $\hbar_{gr}$  is dictated by Equivalence Principle. This inspired the ideas that quantization is due to a condensation of ordinary matter around dark matter concentrated near Bohr orbits and that dark matter is in macroscopic quantum phase in astrophysical scales.

The second crucial empirical input were the anomalies associated with living matter. Mention only the effects of ELF radiation at EEG frequencies on vertebrate brain and anomalous behavior of the ionic currents through cell membrane. If the value of Planck constant is large, the energy of EEG photons is above thermal energy and one can understand the effects on both physiology and behavior. If ionic currents through cell membrane have large Planck constant the scale of quantum coherence is large and one can understand the observed low dissipation in terms of quantum coherence.

As almost all chapters of the books, also this chapter should be seen as a story about evolution of ideas rather than final summary. I have moved some purely mathematical speculations to second chapter to keep emphasis on TGD inspired physics.

#### 14.1.1 The evolution of mathematical ideas

From the beginning the basic challenge -besides the need to deduce a general formula for the quantized Planck constant- was to understand how the quantization of Planck constant is mathematically possible. From the beginning it was clear that since particles with different values of Planck constant cannot appear in the same vertex, a generalization of space-time concept is needed to achieve this.

During last five years or so many deep ideas -both physical and mathematical- related to the construction of quantum TGD have emerged and this has led to a profound change of perspective in this and also other chapters. The overall view about TGD is described briefly in [?].

1. For more than five years ago I realized that von Neumann algebras known as hyperfinite factors of type  $II_1$  (HFFs) are highly relevant for quantum TGD since the Clifford algebra of configuration space ("world of classical worlds", WCW) is direct sum over HFFs. Jones inclusions are particular class of inclusions of HFFs and quantum groups are closely related to them. This led to the conviction that Jones inclusions can provide a detailed understanding of what is involved and predict very simple spectrum for Planck constants associated with  $M^4$  and  $CP_2$  degrees of freedom (later I replaced  $M^4$  by its light cone  $M^4_{\pm}$  and finally with the causal diamond  $CD$  defined as intersection of future and past light-cones of  $M^4$ ). The idea about connection with Jones inclusion can be however questioned and is left another chapter.

2. The notion of zero energy ontology replaces physical states with zero energy states consisting of pairs of positive and negative energy states at the light-like boundaries  $\delta M_{\pm}^4 \times CP_2$  of  $CDs$  forming a fractal hierarchy containing  $CDs$  within  $CDs$ . In standard ontology zero energy state corresponds to a physical event, say particle reaction. This led to the generalization of S-matrix to M-matrix identified as Connes tensor product characterizing time like entanglement between positive and negative energy states. M-matrix is product of square root of density matrix and unitary S-matrix just like Schrödinger amplitude is product of modulus and phase, which means that thermodynamics becomes part of quantum theory and thermodynamical ensembles are realized as single particle quantum states. This led also to a solution of long standing problem of understanding how geometric time of the physicist is related to the experienced time identified as a sequence of quantum jumps interpreted as moments of consciousness [?] in TGD inspired theory of consciousness which can be also seen as a generalization of quantum measurement theory [?] .
3. Another closely related idea was the emergence of measurement resolution as the basic element of quantum theory. Measurement resolution is characterized by inclusion  $\mathcal{M} \subset \mathcal{N}$  of HFFs with  $\mathcal{M}$  characterizing the measurement resolution in the sense that the action of  $\mathcal{M}$  creates states which cannot be distinguished from each other within measurement resolution used. Hence complex rays of state space are replaced with  $\mathcal{M}$  rays. One of the basic challenges is to define the nebulous factor space  $\mathcal{N}/\mathcal{M}$  having finite fractional dimension  $\mathcal{N} : \mathcal{M}$  given by the index of inclusion. It was clear that this space should correspond to quantum counterpart of Clifford algebra of world of classical worlds reduced to a finite-quantum dimensional algebra by the finite measurement resolution [K15] .
4. The realization that light-like 3-surfaces at which the signature of induced metric of space-time surface changes from Minkowskian to Euclidian are ideal candidates for basic dynamical objects besides light-like boundaries of space-time surface was a further decisive step or progress. This led to vision that quantum TGD is almost topological quantum field theory ("almost" because light-likeness brings in induced metric) characterized by Chern-Simons action for induced Kähler gauge potential of  $CP_2$ . Together with zero energy ontology this led to the generalization of the notion of Feynman diagram to a light-like 3-surface for which lines correspond to light-like 3-surfaces and vertices to 2-D partonic surface at which these 3-D surface meet. This means a strong departure from string model picture. The interaction vertices should be given by N-point functions of a conformal field theory with second quantized induced spinor fields defining the basic fields in terms of which also the gamma matrices of world of classical worlds could be constructed as super generators of super conformal symmetries [K15] .
5. By quantum classical correspondence finite measurement resolution should have a space-time correlate. The obvious guess was that this correlate is discretization at the level of construction of M-matrix. In almost-TQFT context the effective replacement of light-like 3-surface with braids defining basic objects of TQFTs is the obvious guess. Also number theoretic universality necessary for the p-adicization of quantum TGD by a process analogous to the completion of rationals to reals and various p-adic number fields requires discretization since only rational and possibly some algebraic points of the imbedding space (in suitable preferred coordinates) allow interpretation both as real and p-adic points. It was clear that the construction of M-matrix boils to the precise understanding of number theoretic braids [K15] .
6. The interaction with M-theory dualities [?] led to a handful of speculations about dualities possible in TGD framework, and one of these dualities-  $M^8 - M^4 \times CP_2$  duality - eventually led to a unique identification of number theoretic braids. The dimensions of partonic 2-surface, space-time, and imbedding space strongly suggest that classical number fields, or more precisely their complexifications might help to understand quantum TGD. If the choice of imbedding space is unique because of uniqueness of infinite-dimensional Kähler geometric existence of world of classical worlds then standard model symmetries coded by  $M^4 \times CP_2$  should have some deeper meaning and the most obvious guess is that  $M^4 \times CP_2$  can be understood geometrically.  $SU(3)$  belongs to the automorphism group of octonions as well as hyper-octonions  $M^8$  identified by subspace of complexified octonions with Minkowskian signature of induced metric. This led to the discovery that hyper-quaternionic 4-surfaces in  $M^8$  can be mapped to  $M^4 \times CP_2$  provided

their tangent space contains preferred  $M^2 \subset M^4 \subset M^4 \times E^4$ . Years later I realized that the map generalizes so that  $M^2$  can depend on the point of  $X^4$ . The interpretation of  $M^2(x)$  is both as a preferred hyper-complex (commutative) sub-space of  $M^8$  and as a local plane of non-physical polarizations so that a purely number theoretic interpretation of gauge conditions emerges in TGD framework. This led to a rapid progress in the construction of the quantum TGD. In particular, the challenge of identifying the preferred extremal of Kähler action associated with a given light-like 3-surface  $X_l^3$  could be solved and the precise relation between  $M^8$  and  $M^4 \times CP_2$  descriptions was understood [K15].

7. Also the challenge of reducing quantum TGD to the physics of second quantized induced spinor fields found a resolution recently [K15]. For years ago it became clear that the vacuum functional of the theory must be the Dirac determinant associated with the induced spinor fields so that the theory would predict all coupling parameters from quantum criticality. Even more, the vacuum functional should correspond to the exponent of Kähler action for a preferred extremal. The problem was that the generalized eigenmodes of Chern-Simons Dirac operator allow a generalized eigenvalues to be arbitrary functions of two coordinates in the directions transversal to the light-like direction of  $X_l^3$ . The progress in the understanding of number theoretic compactification however allowed to understand how the information about the preferred extremal of Kähler action is coded to the spectrum of eigen modes.

The basic idea is simple and I actually discovered it for more than half decade ago but forgot! The generalized eigen modes of 3-D Chern-Simons Dirac operator  $D_{C-S}$  correspond to the zero modes of a 4-D modified Dirac operator defined by Kähler action localized to  $X_l^3$  so that induced spinor fields can be seen as 4-D spinorial shock waves. The led to a concrete interpretation of the eigenvalues as analogous to cyclotron energies of fermion in classical electro-weak magnetic fields defined by the induced spinor connection and a connection with anyon physics emerges by 2-dimensionality of the evolving system. Also it was possible to identify the boundary conditions for the preferred extremal of Kähler action -analog of Bohr orbit- at  $X_l^3$  and also to the vision about how general coordinate invariance allows to use any light-like 3-surface  $X^3 \subset X^4(X_l^3)$  instead of using only wormhole throat to second quantize induced spinor field.

8. It became as a total surprise that due to the huge vacuum degeneracy of induced spinor fields the number of generalized eigenmodes identified in this manner was finite. The good news was that the theory is manifestly finite and zeta function regularization is not needed to define the Dirac determinant. The manifest finiteness had been actually must-be-true from the beginning. The apparently bad news was that the Clifford algebra of WCW world constructed from the oscillator operators is bound to be finite-dimensional. The resolution of the paradox comes from the realization that this algebra represents the somewhat mysterious coset space  $\mathcal{N}/\mathcal{M}$  so that finite measurement resolution and the notion inclusion are coded by the vacuum degeneracy of Kähler action and the maximally economical description in terms of inclusions emerges automatically.
9. A unique identification of number theoretic braids became also possible and relates to the construction of the generalized imbedding space by gluing together singular coverings and factor spaces of  $CD \setminus M^2$  and  $CP_2 \setminus S_I^2$  to form a book like structure. Here  $M^2$  is preferred plane of  $M^4$  defining quantization axis of energy and angular momentum and  $S_I^2$  is one of the two geodesic sphere of  $CP_2$ . The interpretation of the selection of these sub-manifolds is as a geometric correlate for the selection of quantization axes and  $CD$  defining basic sector of world of classical worlds is replaced by a union corresponding to these choices. Number theoretic braids come in too variants dual to each other, and correspond to the intersection of  $M^2$  and  $M^4$  projection of  $X_l^3$  on one hand and  $S_I^2$  and  $CP_2$  projection of  $X_l^3$  on the other hand. This is simplest option and would mean that the points of number theoretic braid belong to  $M^2$  ( $S_I^2$ ) and are thus quantum critical although entire  $X^2$  at the boundaries of  $CD$  belongs to a fixed page of the Big Book. This means solution of a long standing problem of understanding in what sense TGD Universe is quantum critical. The phase transitions changing Planck constant correspond to tunneling represented geometrically by a leakage of partonic 2-surface from a page of Big Book to another one.
10. Few years ago came the realization that it could be only effective but have same practical implications. The basic observation was that the effective hierarchy need not be postulated

separately but follows as a prediction from the vacuum degeneracy of Kähler action. In this formulation Planck constant at fundamental level has its standard value and its effective values come as its integer multiples so that one should write  $\hbar_{eff} = n\hbar$  rather than  $\hbar = n\hbar_0$  as I have done. For most practical purposes the states in question would behave as if Planck constant were an integer multiple of the ordinary one. This reduces the understanding of the effective hierarchy of Planck constants to quantum variant of multi-furcations for the dynamics of preferred extremals of Kähler action. The number of branches of multifurcation defines the integer  $n$  in  $\hbar_{eff} = n\hbar$ .

### 14.1.2 The evolution of physical ideas

The evolution of physical ideas related to the hierarchy of Planck constants and dark matter as a hierarchy of phases of matter with non-standard value of Planck constants was much faster than the evolution of mathematical ideas and quite a number of applications have been developed during last five years.

1. The basic idea was that ordinary matter condenses around dark matter which is a phase of matter characterized by non-standard value of Planck constant.
2. The realization that non-standard values of Planck constant give rise to charge and spin fractionization and anyonization led to the precise identification of the prerequisites of anyonic phase [?] . If the partonic 2-surface, which can have even astrophysical size, surrounds the tip of  $CD$ , the matter at the surface is anyonic and particles are confined at this surface. Dark matter could be confined inside this kind of light-like 3-surfaces around which ordinary matter condenses. If the radii of the basic pieces of these nearly spherical anyonic surfaces - glued to a connected structure by flux tubes mediating gravitational interaction - are given by Bohr rules, the findings of Nottale [E23] can be understood. Dark matter would resemble to a high degree matter in black holes replaced in TGD framework by light-like partonic 2-surfaces with minimum size of order Schwarzschild radius  $r_S$  of order scaled up Planck length:  $r_S \sim \sqrt{\hbar G}$ . Black hole entropy being inversely proportional to  $\hbar$  is predicted to be of order unity so that dramatic modification of the picture about black holes is implied.
3. Darkness is a relative concept and due to the fact that particles at different pages of book cannot appear in the same vertex of the generalized Feynman diagram. The phase transitions in which partonic 2-surface  $X^2$  during its travel along  $X_1^3$  leaks to different page of book are however possible and change Planck constant so that particle exchanges of this kind allow particles at different pages to interact. The interactions are strongly constrained by charge fractionization and are essentially phase transitions involving many particles. Classical interactions are also possible. This allows to conclude that we are actually observing dark matter via classical fields all the time and perhaps have even photographed it [?] , [?] .
4. Perhaps the most fascinating applications are in biology. The anomalous behavior ionic currents through cell membrane (low dissipation, quantal character, no change when the membrane is replaced with artificial one) has a natural explanation in terms of dark supra currents. This leads to a vision about how dark matter and phase transitions changing the value of Planck constant could relate to the basic functions of cell, functioning of DNA and aminoacids, and to the mysteries of bio-catalysis. This leads also a model for EEG interpreted as a communication and control tool of magnetic body containing dark matter and using biological body as motor instrument and sensory receptor. One especially shocking outcome is the emergence of genetic code of vertebrates from the model of dark nuclei as nuclear strings [K44, ?] , [K44] .

### 14.1.3 Brief summary about the generalization of the imbedding space concept

A brief summary of the basic vision in order might help reader to assimilate the more detailed representation about the generalization of imbedding space, which has turned to be only a useful auxiliary tool of the theory rather than basic postulate.

1. The original belief was that the hierarchy of Planck constants cannot be realized without generalizing the notions of imbedding space and space-time since particles with different values of Planck constant cannot appear in the same interaction vertex. This suggests some kind of book like structure for both  $M^4$  and  $CP_2$  factors of the generalized imbedding space is suggestive. It has turned out that the view about hierarchy of Planck constants as effective hierarchy allows to regard the singular coverings of imbedding space as the natural auxiliary tool to describe the quantum view about multi-furcations of preferred extremals.
2. Schrödinger equation suggests that Planck constant corresponds to a scaling factor of  $M^4$  metric whose value labels different pages of the book. The scaling of  $M^4$  coordinate so that original metric results in  $M^4$  factor is possible so that the scaling of  $\hbar$  corresponds to the scaling of the size of causal diamond  $CD$  defined as the intersection of future and past directed light-cones. The light-like 3-surfaces having their 2-D and light-boundaries of  $CD$  are in a key role in the realization of zero energy states. The infinite-D spaces formed by these 3-surfaces define the fundamental sectors of the configuration space (world of classical worlds). Since the scaling of  $CD$  does not simply scale space-time surfaces, the coding of radiative corrections to the geometry of space-time sheets becomes possible and Kähler action can be seen as expansion in powers of  $\hbar/\hbar_0$ .
3. Quantum criticality of TGD Universe is one of the key postulates of quantum TGD. The most important implication is that Kähler coupling strength is analogous to critical temperature. The exact realization of quantum criticality would be in terms of critical sub-manifolds of  $M^4$  and  $CP_2$  common to all sectors of the generalized imbedding space. Quantum criticality would mean that the two kinds of number theoretic braids assignable to  $M^4$  and  $CP_2$  projections of the partonic 2-surface belong by the definition of number theoretic braids to these critical sub-manifolds. At the boundaries of  $CD$  associated with positive and negative energy parts of zero energy state in given time scale partonic two-surfaces belong to a fixed page of the Big Book whereas light-like 3-surface decomposes into regions corresponding to different values of Planck constant much like matter decomposes to several phases at thermodynamical criticality.

#### 14.1.4 Basic physical picture as it is now

The basic phenomenological rules are simple and remained roughly the same during years.

1. The phases with non-standard values of effective Planck constant are identified as dark matter. The motivation comes from the natural assumption that only the particles with the same value of effective Planck can appear in the same vertex. One can illustrate the situation in terms of the book metaphor. Imbedding spaces with different values of Planck constant form a book like structure and matter can be transferred between different pages only through the back of the book where the pages are glued together. One important implication is that light exotic charged particles lighter than weak bosons are possible if they have non-standard value of Planck constant. The standard argument excluding them is based on decay widths of weak bosons and has led to a neglect of large number of particle physics anomalies [?].
2. Large effective or real value of Planck constant scales up Compton length - or at least de Broglie wave length - and its geometric correlate at space-time level identified as size scale of the space-time sheet assignable to the particle. This could correspond to the Kähler magnetic flux tube for the particle forming consisting of two flux tubes at parallel space-time sheets and short flux tubes at ends with length of order  $CP_2$  size.

This rule has far reaching implications in quantum biology and neuroscience since macroscopic quantum phases become possible as the basic criterion stating that macroscopic quantum phase becomes possible if the density of particles is so high that particles as Compton length sized objects overlap. Dark matter therefore forms macroscopic quantum phases. One implication is the explanation of mysterious looking quantal effects of ELF radiation in EEG frequency range on vertebrate brain:  $E = hf$  implies that the energies for the ordinary value of Planck constant are much below the thermal threshold but large value of Planck constant changes the situation. Also the phase transitions modifying the value of Planck constant and changing the lengths of

flux tubes (by quantum classical correspondence) are crucial as also reconnections of the flux tubes.

The hierarchy of Planck constants suggests also a new interpretation for FQHE (fractional quantum Hall effect) [?] in terms of anyonic phases with non-standard value of effective Planck constant realized in terms of the effective multi-sheeted covering of imbedding space: multi-sheeted space-time is to be distinguished from many-sheeted space-time.

In astrophysics and cosmology the implications are even more dramatic. It was Nottale [E23] who first introduced the notion of gravitational Planck constant as  $\hbar_{gr} = GMm/v_0$ ,  $v_0 < 1$  has interpretation as velocity light parameter in units  $c = 1$ . This would be true for  $GMm/v_0 \geq 1$ . The interpretation of  $\hbar_{gr}$  in TGD framework is as an effective Planck constant associated with space-time sheets mediating gravitational interaction between masses  $M$  and  $m$ . The huge value of  $\hbar_{gr}$  means that the integer  $\hbar_{gr}/\hbar_0$  interpreted as the number of sheets of covering is gigantic and that Universe possesses gravitational quantum coherence in super-astronomical scales for masses which are large. This changes the view about gravitons and suggests that gravitational radiation is emitted as dark gravitons which decay to pulses of ordinary gravitons replacing continuous flow of gravitational radiation.

3. Why Nature would like to have large effective value of Planck constant? A possible answer relies on the observation that in perturbation theory the expansion takes in powers of gauge couplings strengths  $\alpha = g^2/4\pi\hbar$ . If the effective value of  $\hbar$  replaces its real value as one might expect to happen for multi-sheeted particles behaving like single particle,  $\alpha$  is scaled down and perturbative expansion converges for the new particles. One could say that Mother Nature loves theoreticians and comes in rescue in their attempts to calculate. In quantum gravitation the problem is especially acute since the dimensionless parameter  $GMm/\hbar$  has gigantic value. Replacing  $\hbar$  with  $\hbar_{gr} = GMm/v_0$  the coupling strength becomes  $v_0 < 1$ .

### 14.1.5 Space-time correlates for the hierarchy of Planck constants

The hierarchy of Planck constants was introduced to TGD originally as an additional postulate and formulated as the existence of a hierarchy of imbedding spaces defined as Cartesian products of singular coverings of  $M^4$  and  $CP_2$  with numbers of sheets given by integers  $n_a$  and  $n_b$  and  $\hbar = n\hbar_0$ ,  $n = n_a n_b$ .

With the advent of zero energy ontology, it became clear that the notion of singular covering space of the imbedding space could be only a convenient auxiliary notion. Singular means that the sheets fuse together at the boundary of multi-sheeted region. The effective covering space emerges naturally from the vacuum degeneracy of Kähler action meaning that all deformations of canonically imbedded  $M^4$  in  $M^4 \times CP_2$  have vanishing action up to fourth order in small perturbation. This is clear from the fact that the induced Kähler form is quadratic in the gradients of  $CP_2$  coordinates and Kähler action is essentially Maxwell action for the induced Kähler form. The vacuum degeneracy implies that the correspondence between canonical momentum currents  $\partial L_K/\partial(\partial_\alpha h^k)$  defining the modified gamma matrices [?] and gradients  $\partial_\alpha h^k$  is not one-to-one. Same canonical momentum current corresponds to several values of gradients of imbedding space coordinates. At the partonic 2-surfaces at the light-like boundaries of  $CD$  carrying the elementary particle quantum numbers this implies that the two normal derivatives of  $h^k$  are many-valued functions of canonical momentum currents in normal directions.

Multi-furcation is in question and multi-furcations are indeed generic in highly non-linear systems and Kähler action is an extreme example about non-linear system. What multi-furcation means in quantum theory? The branches of multi-furcation are obviously analogous to single particle states. In quantum theory second quantization means that one constructs not only single particle states but also the many particle states formed from them. At space-time level single particle states would correspond to  $N$  branches  $b_i$  of multi-furcation carrying fermion number. Two-particle states would correspond to 2-fold covering consisting of 2 branches  $b_i$  and  $b_j$  of multi-furcation.  $N$ -particle state would correspond to  $N$ -sheeted covering with all branches present and carrying elementary particle quantum numbers. The branches co-incide at the partonic 2-surface but since their normal space data are different they correspond to different tensor product factors of state space. Also now the factorization  $N = n_a n_b$  occurs but now  $n_a$  and  $n_b$  would relate to branching in the direction of space-like 3-surface and light-like 3-surface rather than  $M^4$  and  $CP_2$  as in the original hypothesis.

In light of this the working hypothesis adopted during last years has been too limited: for some reason I ended up to propose that only  $N$ -sheeted covering corresponding to a situation in which all



$N$  branches are present is possible. Before that I quite correctly considered more general option based on intuition that one has many-particle states in the multi-sheeted space. The erratic form of the working hypothesis has not been used in applications.

Multi-furcations relate closely to the quantum criticality of Kähler action. Feigenbaum bifurcations represent a toy example of a system which via successive bifurcations approaches chaos. Now more general multi-furcations in which each branch of given multi-furcation can multi-furcate further, are possible unless on poses any additional conditions. This allows to identify additional aspect of the geometric arrow of time. Either the positive or negative energy part of the zero energy state is "prepared" meaning that single  $n$ -sub-furcations of  $N$ -furcation is selected. The most general state of this kind involves superposition of various  $n$ -sub-furcations.

In this chapter I try to summarize the evolution of the ideas related to Planck constant without systematic attempt to achieve complete internal consistency. I have left the summary about the recent views to the end of the chapter and the reader might find it a good idea to begin from this section.

## 14.2 Experimental input

In this section basic experimental inputs suggesting a hierarchy of Planck constants and the identification of dark matter as phases with non-standard value of Planck constant are discussed.

### 14.2.1 Hints for the existence of large $\hbar$ phases

Quantum classical correspondence suggests the identification of space-time sheets identifiable as quantum coherence regions. Since they can have arbitrarily large sizes, phases with arbitrarily large quantum coherence lengths and arbitrarily long de-coherence times seem to be possible in TGD Universe. In standard physics context this seems highly implausible. If Planck constant can have arbitrarily large values, the situation changes since Compton lengths and other quantum scales are proportional to  $\hbar$ . Dark matter is excellent candidate for large  $\hbar$  phases.

The expression for  $\hbar_{gr}$  in the model explaining the Bohr orbits for planets is of form  $\hbar_{gr} = GM_1M_2/v_0$  [K65]. This suggests that the interaction is associated with some kind of interface between the systems, perhaps join along boundaries connecting the space-time sheets associated with systems possessing gravitational masses  $M_1$  and  $M_2$ . Also a large space-time sheet carrying the mutual classical gravitational field could be in question. This argument generalizes to the case  $\hbar/\hbar_0 = Q_1Q_2\alpha/v_0$  in case of generic phase transition to a strongly interacting phase with  $\alpha$  describing gauge coupling strength.

There exist indeed some experimental indications for the existence of phases with a large  $\hbar$ .

1. With inspiration coming from the finding of Nottale [E23] I have proposed an explanation of dark matter as a macroscopic quantum phase with a large value of  $\hbar$  [K65]. Any interaction, if sufficiently strong, can lead to this kind of phase. The increase of  $\hbar$  would make the fine structure constant  $\alpha$  in question small and guarantee the convergence of perturbation series.
2. Living matter could represent a basic example of large  $\hbar$  phase [K21, K4]. Even ordinary condensed matter could be "partially dark" in many-sheeted space-time [K23]. In fact, the realization of hierarchy of Planck constants leads to a considerably weaker notion of darkness stating that only the interaction vertices involving particles with different values of Planck constant are impossible and that the notion of darkness is relative notion. For instance, classical interactions and photon exchanges involving a phase transition changing the value of  $\hbar$  of photon are possible in this framework.
3. There is claim about a detection in RHIC (Relativistic Heavy Ion Collider in Brookhaven) of states behaving in some respects like mini black holes [?]. These states could have explanation as color flux tubes at Hagedorn temperature forming a highly tangled state and identifiable as stringy black holes of strong gravitation. The strings would carry a quantum coherent color glass condensate, and would be characterized by a large value of  $\hbar$  naturally resulting in confinement phase with a large value of  $\alpha_s$  [K66]. The progress in hadronic mass calculations led to a concrete model of color glass condensate of single hadron as many-particle state of super-symplectic

gluons [K46, K43] - something completely new from the point of QCD - responsible for non-perturbative aspects of hadron physics. In RHIC events these color glass condensate would fuse to single large condensate. This condensate would be present also in ordinary black-holes and the blackness of black-hole would be darkness.

4. I have also discussed a model for cold fusion based on the assumption that nucleons can be in large  $\hbar$  phase. In this case the relevant strong interaction strength is  $Q_1 Q_2 \alpha_{em}$  for two nucleon clusters inside nucleus which can increase  $\hbar$  so large that the Compton length of protons becomes of order atomic size and nuclear protons form a macroscopic quantum phase [K23, K21] .

### 14.2.2 Quantum coherent dark matter and $\hbar$

The argument based on gigantic value of  $\hbar_{gr}$  explaining darkness of dark mater is attractive but one should be very cautious.

Consider first ordinary QED  $e = \sqrt{\alpha 4\pi\hbar}$  appears in vertices so that perturbation expansion in powers of  $\sqrt{\hbar}$  basically. This would suggest that large  $\hbar$  leads to large effects. All predictions are however in powers of alpha and large  $\hbar$  means small higher order corrections. What happens can be understood on basis of dimensional analysis. For instance, cross sections are proportional to  $(\hbar/m)^2$ , where  $m$  is the relevant mass and the remaining factor depends on  $\alpha = e^2/(4\pi\hbar)$  only. In the more general case tree amplitudes with  $n$  vertices are proportional to  $e^n$  and thus to  $\hbar^{n/2}$  and loop corrections give only powers of  $\alpha$  which get smaller when  $\hbar$  increases. This must relate to the powers of  $1/\hbar$  from the integration measure associated with the momentum loop integrals affected by the change of  $\alpha$ .

Consider now the effects of the scaling of  $\hbar$ . The scaling of Compton lengths and other quantum kinematical parameters is the most obvious effect. An obvious effect is due to the change of  $\hbar$  in the commutation relations and in the change of unit of various quantum numbers. In particular, the right hand side of oscillator operator commutation and anti-commutation relations is scaled. A further effect is due to the scaling of the eigenvalues of the modified Dirac operator  $\hbar\Gamma^\alpha D_\alpha$ .

The exponent  $exp(K)$  of Kähler function  $K$  defining perturbation series in the configuration space degrees of freedom is proportional to  $1/g_K^2$  and does not depend on  $\hbar$  at all if there is only single Planck constant. The propagator is proportional to  $g_K^2$ . This can be achieved also in QED by absorbing  $e$  from vertices to  $e^2$  in photon propagator. Hence it would seem that the dependence on  $\alpha_K$  (and  $\hbar$ ) must come from vertices which indeed involve Jones inclusions of the  $II_1$  factors of the incoming and outgoing lines.

This however suggests that the dependence of the scattering amplitudes on  $\hbar$  is purely kinematical so that all higher radiative corrections would be absent. This seems to leave only one option: the scale factors of covariant  $CD$  and  $CP_2$  metrics can vary and might have discrete spectrum of values.

1. The invariance of Kähler action with respect to overall scaling of metric however allows to keep  $CP_2$  metric fixed and consider only a spectrum for the scale factors of  $M^4$  metric.
2. The first guess motivated by Schrödinger equation is that the scaling factor of covariant  $CD$  metric corresponds the ratio  $r^2 = (\hbar/\hbar_0)^2$ . This would mean that the value of Kähler action depends on  $r^2$ . The scaling of  $M^4$  coordinate by  $r$  the metric reduces to the standard form but if causal diamonds with quantized temporal distance between their tips are the basic building blocks of the configuration space geometry as zero energy ontology requires, this scaling of  $\hbar$  scales the size of  $CD$  by  $r$  so that genuine effect results since  $M^4$  scalings are not symmetries of Kähler action.
3. In this picture  $r$  would code for radiative corrections to Kähler function and thus space-time physics. Even in the case that the radiative corrections to the configuration space functional integral vanish, as suggested by quantum criticality, they would be actually taken into account.

This kind of dynamics is not consistent with the original view about imbedding space and forces to generalize the notion of imbedding spaces since it is clear that particles with different Planck constants cannot appear in the same vertex of Feynman diagram. Somehow different values of Planck constant must be analogous to different pages of book having almost copies of imbedding space as pages. A possible resolution of the problem comes from the realization that the fundamental structure might be

the inclusion hierarchy of number theoretical Clifford algebras from which entire TGD could emerge including generalization of the imbedding space concept.

### 14.2.3 The phase transition changing the value of Planck constant as a transition to non-perturbative phase

#### A phase transition increasing $\hbar$ as a transition guaranteeing the convergence of perturbation theory

The general vision is that a phase transition increasing  $\hbar$  occurs when perturbation theory ceases to converge. Very roughly, this would occur when the parameter  $x = Q_1 Q_2 \alpha$  becomes larger than one. The net quantum numbers for "spontaneously magnetized" regions provide new natural units for quantum numbers. The assumption that standard quantization rules prevail poses very strong restrictions on allowed physical states and selects a subspace of the original configuration space. One can of course, consider the possibility of giving up these rules at least partially in which case a spectrum of fractionally charged anyon like states would result with confinement guaranteed by the fractionization of charges.

The necessity of large  $\hbar$  phases has been actually highly suggestive since the first days of quantum mechanics. The classical looking behavior of macroscopic quantum systems remains still a poorly understood problem and large  $\hbar$  phases provide a natural solution of the problem.

In TGD framework quantum coherence regions correspond to space-time sheets. Since their sizes are arbitrarily large the conclusion is that macroscopic and macro-temporal quantum coherence are possible in all scales. Standard quantum theory definitely fails to predict this and the conclusion is that large  $\hbar$  phases for which quantum length and time scales are proportional to  $\hbar$  and long are needed.

Somewhat paradoxically, large  $\hbar$  phases explain the effective classical behavior in long length and time scales. Quantum perturbation theory is an expansion in terms of gauge coupling strengths inversely proportional to  $\hbar$  and thus at the limit of large  $\hbar$  classical approximation becomes exact. Also the Coulombic contribution to the binding energies of atoms vanishes at this limit. The fact that we experience world as a classical only tells that large  $\hbar$  phase is essential for our sensory perception. Of course, this is not the whole story and the full explanation requires a detailed anatomy of quantum jump.

#### The criterion for the occurrence of the phase transition increasing the value of $\hbar$

In the case of planetary orbits the large value of  $\hbar_{gr} = 2GM/v_0$  makes possible to apply Bohr quantization to planetary orbits. This leads to a more general idea that the phase transition increasing  $\hbar$  occurs when the system consisting of interacting units with charges  $Q_i$  becomes non-perturbative in the sense that the perturbation series in the coupling strength  $\alpha Q_i Q_j$ , where  $\alpha$  is the appropriate coupling strength and  $Q_i Q_j$  represents the maximum value for products of gauge charges, ceases to converge. Thus Mother Nature would resolve the problems of theoretician. A primitive formulation for this criterion is the condition  $\alpha Q_i Q_j \geq 1$ .

The first working hypothesis was the existence of dark matter hierarchies with  $\hbar = \lambda^k \hbar_0$ ,  $k = 0, 1, \dots$ ,  $\lambda = n/v_0$  or  $\lambda = 1/nv_0$ ,  $v_0 \simeq 2^{-11}$ . This rule turned out to be quite too specific. The mathematically plausible formulation predicts that in principle any rational value for  $r = \hbar(M^4)/\hbar(CP_2)$  is possible but there are certain number theoretically preferred values of  $r$  such as those coming powers of 2.

## 14.3 A generalization of the notion of imbedding space as a realization of the hierarchy of Planck constants

In the following the basic ideas concerning the realization of the hierarchy of Planck constants are summarized and after that a summary about generalization of the imbedding space is given. In [?] the important delicacies associated with the Kähler structure of generalized imbedding space are discussed. The background for the recent vision is quite different from that for half decade ago. Zero energy ontology and the notion of causal diamond, number theoretic compactification leading to the

precise identification of number theoretic braids, the realization of number theoretic universality, and the understanding of the quantum dynamics at the level of modified Dirac action fix to a high degree the vision about generalized imbedding space.

### 14.3.1 Basic ideas

The first key idea in the geometric realization of the hierarchy of Planck constants emerges from the study of Schrödinger equation and states that Planck constant appears a scaling factor of  $M^4$  metric. Second key idea is the connection with Jones inclusions inspiring an explicit formula for Planck constants. For a long time this idea remained heuristic must-be-true feeling but the recent view about quantum TGD provide a justification for it.

#### Scaling of Planck constant and scalings of $CD$ and $CP_2$ metrics

The key property of Schrödinger equation is that kinetic energy term depends on  $\hbar$  whereas the potential energy term has no dependence on it. This makes the scaling of  $\hbar$  a non-trivial transformation. If the contravariant metric scales as  $r = \hbar/\hbar_0$  the effect of scaling of Planck constant is realized at the level of imbedding space geometry provided it is such that it is possible to compare the regions of generalized imbedding space having different value of Planck constant.

In the case of Dirac equation same conclusion applies and corresponds to the minimal substitution  $p - eA \rightarrow i\hbar\nabla - eA$ . Consider next the situation in TGD framework.

1. The minimal substitution  $p - eA \rightarrow i\hbar\nabla - eA$  does not make sense in the case of  $CP_2$  Dirac operator since, by the non-triviality of spinor connection, one cannot choose the value of  $\hbar$  freely. In fact, spinor connection of  $CP_2$  is defined in such a manner that spinor connection corresponds to the quantity  $\hbar eQA$ , where denotes  $A$  gauge potential, and there is no natural manner to separate  $\hbar e$  from it.
2. The contravariant  $CD$  metric scales like  $\hbar^2$ . In the case of Dirac operator in  $M^4 \times CP_2$  one can assign separate Planck constants to Poincare and color algebras and the scalings of  $CD$  and  $CP_2$  metrics induce scalings of corresponding values of  $\hbar^2$ . As far as Kähler action is considered,  $CP_2$  metric could be always thought of being scaled to its standard form.
3. Dirac equation gives the eigenvalues of wave vector squared  $k^2 = k^i k_i$  rather than four-momentum squared  $p^2 = p^i p_i$  in  $CD$  degrees of freedom and its analog in  $CP_2$  degrees of freedom. The values of  $k^2$  are proportional to  $1/r^2$  so that  $p^2$  does not depend on it for  $p^i = \hbar k^i$ : analogous conclusion applies in  $CP_2$  degrees of freedom. This gives rise to the invariance of mass squared and the desired scaling of wave vector when  $\hbar$  changes.

This consideration generalizes to the case of the induced gamma matrices and induced metric in  $X^4$ , modified Dirac operator, and Kähler action which carry dynamical information about the ratio  $r = \hbar_{eff}/\hbar_0$ .

#### Kähler function codes for a perturbative expansion in powers of $\hbar(CD)/\hbar(CP_2)$

Suppose that one accepts that the spectrum of  $CD$  resp.  $CP_2$  Planck constants is accompanied by a hierarchy of overall scalings of covariant  $CD$  (causal diamond) metric by  $(\hbar(M^4)/\hbar_0)^2$  and  $CP_2$  metric by  $(\hbar(CP_2)/\hbar_0)^2$  followed by overall scaling by  $r^2 = (\hbar_0/\hbar(CP_2))^2$  so that  $CP_2$  metric suffers no scaling and difficulties with isometric gluing procedure of sectors are avoided.

The first implication of this picture is that the modified Dirac operator determined by the induced metric and spinor structure depends on  $r$  in a highly nonlinear manner but there is no dependence on the overall scaling of the  $H$  metric. This in turn implies that the fermionic oscillator algebra used to define configuration space spinor structure and metric depends on the value of  $r$ . Same is true also for Kähler action and configuration space Kähler function. Hence Kähler function is analogous to an effective action expressible as infinite series in powers of  $r$ .

This interpretation allows to overcome the paradox caused by the hypothesis that loop corrections to the functional integral over configuration space defined by the exponent of Kähler function serving as vacuum functional vanish so that tree approximation is exact. This would imply that all higher order corrections usually interpreted in terms of perturbative series in powers of  $1/\hbar$  vanish. The paradox

would result from the fact that scattering amplitudes would not receive higher order corrections and classical approximation would be exact.

The dependence of both states created by Super Kac-Moody algebra and the Kähler function and corresponding propagator identifiable as contravariant configuration space metric would mean that the expressions for scattering amplitudes indeed allow an expression in powers of  $r$ . What is so remarkable is that the TGD approach would be non-perturbative from the beginning and "semiclassical" approximation, which might be actually exact, automatically would give a full expansion in powers of  $r$ . This is in a sharp contrast to the usual quantization approach.

### Jones inclusions and hierarchy of Planck constants

From the beginning it was clear that Jones inclusions of hyper-finite factors of type  $II_1$  are somehow related to the hierarchy of Planck constants. The basic motivation for this belief has been that configuration space Clifford algebra provides a canonical example of hyper-finite factor of type  $II_1$  and that Jones inclusion of these Clifford algebras is excellent candidate for a first principle description of finite measurement resolution.

Consider the inclusion  $\mathcal{N} \subset \mathcal{M}$  of hyper-finite factors of type  $II_1$  [K82]. A deep result is that one can express  $\mathcal{M}$  as  $\mathcal{N} : \mathcal{M}$ -dimensional module over  $\mathcal{N}$  with fractal dimension  $\mathcal{N} : \mathcal{M} = B_n$ .  $\sqrt{b_n}$  represents the dimension of a space of spinor space renormalized from the value 2 corresponding to  $n = \infty$  down to  $\sqrt{b_n} = 2\cos(\pi/n)$  varying thus in the range  $[1, 2]$ .  $B_n$  in turn would represent the dimension of the corresponding Clifford algebra. The interpretation is that finite measurement resolution introduces correlations between components of quantum spinor implying effective reduction of the dimension of quantum spinors providing a description of the factor space  $\mathcal{N}/\mathcal{M}$ .

This would suggest that somehow the hierarchy of Planck constants must represent finite measurement resolution and since phase factors coming as roots of unity are naturally associated with Jones inclusions the natural guess was that angular resolution and coupling constant evolution associated with it is in question. This picture would suggest that the realization of the hierarchy of Planck constant in terms of a book like structure of generalized imbedding space provides also a geometric realization for a hierarchy of Jones inclusions.

The notion of number theoretic braid and realization that the modified Dirac operator has only finite number of generalized eigenmodes -thanks to the vacuum degeneracy of Kähler action- finally led to the understanding how the notion of finite measurement resolution is coded to the Kähler action and the realized in practice by second quantization of induced spinor fields and how these spinor fields endowed with q-anticommutation relations give rise to a representations of finite-quantum dimensional factor spaces  $\mathcal{N}/\mathcal{M}$  associated with the hierarchy of Jones inclusions having generalized imbedding space as space-time correlate. This means enormous simplification since infinite-dimensional spinor fields in infinite-dimensional world of classical worlds are replaced with finite-quantum-dimensional spinor fields in discrete points sets provided by number theoretic braids.

The study of a concrete model for Jones inclusions in terms of finite subgroups  $G$  of  $SU(2)$  defining sub-algebras of infinite-dimensional Clifford algebra as fixed point sub-algebras leads to what looks like a correct track concerning the understanding of quantization of Planck constants.

The ADE diagrams of  $A_n$  and  $D_{2n}$  characterize cyclic and dihedral groups whereas those of  $E_6$  and  $E_8$  characterize tetrahedral and icosahedral groups. This approach leads to the hypothesis that the scaling factor of Planck constant assignable to Poincare (color) algebra corresponds to the order of the maximal cyclic subgroup of  $G_b \subset SU(2)$  ( $G_a \subset SL(2, C)$ ) acting as symmetry of space-time sheet in  $CP_2$  ( $CD$ ) degrees of freedom. It predicts arbitrarily large  $CD$  and  $CP_2$  Planck constants in the case of  $A_n$  and  $D_{2n}$  under rather general assumptions.

There are two manners for how  $G_a$  and  $G_b$  can act as symmetries corresponding to  $G_i$  coverings and factor spaces. These coverings and factor spaces are singular and associated with spaces  $\hat{C}D \setminus M^2$  and  $CP_2 \setminus S_I^2$ , where  $S_I^2$  is homologically trivial geodesic sphere of  $CP_2$ . The physical interpretation is that  $M^2$  and  $S_I^2$  fix preferred quantization axes for energy and angular moment and color quantum numbers so that also a connection with quantum measurement theory emerges.

#### 14.3.2 The vision

A brief summary of the basic vision behind the generalization of the imbedding space concept needed to realize the hierarchy of Planck constants is in order before going to the detailed representation.

1. The hierarchy of Planck constants cannot be realized without generalizing the notions of imbedding space and space-time because particles with different values of Planck constant cannot appear in the same interaction vertex. Some kind of book like structure for the generalized imbedding space forced also by p-adicization but in different sense is suggestive. Both  $M^4$  and  $CP_2$  factors would have the book like structure so that a Cartesian product of books would be in question.
2. The study of Schrödinger equation suggests that Planck constant corresponds to a scaling factor of  $CD$  metric whose value labels different pages of the book. The scaling of  $M^4$  coordinate so that original metric results in  $CD$  factor is possible so that the interpretation for scaled up value of  $\hbar$  is as scaling of the size of causal diamond  $CD$ .
3. The light-like 3-surfaces having their 2-D and light-boundaries of  $CD$  are in a key role in the realization of zero energy states, and the infinite-D spaces of light-like 3-surfaces inside scaled variants of  $CD$  define the fundamental building brick of the configuration space (world of classical worlds). Since the scaling of  $CD$  does not simply scale space-time surfaces the effect of scaling on classical and quantum dynamics is non-trivial and a coupling constant evolution results and the coding of radiative corrections to the geometry of space-time sheets becomes possible. The basic geometry of  $CD$  suggests that the allowed sizes of  $CD$  come in the basic sector  $\hbar = \hbar_0$  as powers of two. This predicts p-adic length scale hypothesis and lead to number theoretically universal discretized p-adic coupling constant evolution. Since the scaling is accompanied by a formation of singular coverings and factor spaces, different scales are distinguished at the level of topology. p-Adic length scale hierarchy affords similar characterization of length scales in terms of effective topology.
4. The idea that TGD Universe is quantum critical in some sense is one of the key postulates of quantum TGD. The basic ensuing prediction is that Kähler coupling strength is analogous to critical temperature. Quantum criticality in principle fixes the p-adic evolution of various coupling constants also the value of gravitational constant. The exact realization of quantum criticality would be in terms of critical sub-manifolds of  $M^4$  and  $CP_2$  common to all sectors of the generalized imbedding space. Quantum criticality of TGD Universe means that the two kinds of number theoretic braids assignable to  $M^4$  and  $CP_2$  projections of the partonic 2-surface belong by the very definition of number theoretic braids to these critical sub-manifolds. At the boundaries of  $CD$  associated with positive and negative energy parts of zero energy state in a given time scale partonic two-surfaces belong to a fixed page of the Big Book whereas light-like 3-surface decomposes to regions corresponding to different values of Planck constant much like matter decomposes to several phases at criticality.

The connection with Jones inclusions was originally a purely heuristic guess, and it took half decade to really understand why and how they are involved. The notion of measurement resolution is the key concept.

1. The key observation is that Jones inclusions are characterized by a finite subgroup  $G \subset SU(2)$  and the this group also characterizes the singular covering or factor spaces associated with  $CD$  or  $CP_2$  so that the pages of generalized imbedding space could indeed serve as correlates for Jones inclusions.
2. The dynamics of Kähler action realizes finite measurement resolution in terms of finite number of modes of the induced spinor field automatically implying cutoffs to the representations of various super-conformal algebras typical for the representations of quantum groups associated with Jones inclusions. The interpretation of the Clifford algebra spanned by the fermionic oscillator operators is as a realization for the concept of the factor space  $\mathcal{N}/\mathcal{M}$  of hyper-finite factors of type  $II_1$  identified as the infinite-dimensional Clifford algebra  $\mathcal{N}$  of the configuration space and included algebra  $\mathcal{M}$  determining the finite measurement resolution for angle measurement in the sense that the action of this algebra on zero energy state has no detectable physical effects.  $\mathcal{M}$  takes the role of complex numbers in quantum theory and makes physics non-commutative. The resulting quantum Clifford algebra has anti-commutation relations dictated by the fractionization of fermion number so that unit becomes  $r = \hbar/\hbar_0$ .  $SU(2)$  Lie algebra transforms to its quantum variant corresponding to the quantum phase  $q = \exp(i2\pi/r)$ .

3.  $G$  invariance for the elements of the included algebra can be interpreted in terms of finite measurement resolution in the sense that action by  $G$  invariant Clifford algebra element has no detectable effects. Quantum groups realize this view about measurement resolution for angle measurement. The  $G$ -invariance of the physical states created by fermionic oscillator operators which by definition are not  $G$  invariant guarantees that quantum states as a whole have non-fractional quantum numbers so that the leakage between different pages is possible in principle. This hypothesis is consistent with the TGD inspired model of quantum Hall effect [?] .
4. Concerning the formula for Planck constant in terms of the integers  $n_a$  and  $n_b$  characterizing orders of the maximal cyclic subgroups of groups  $G_a$  and  $G_b$  defining coverings and factor spaces associated with  $CD$  and  $CP_2$  the basic constraint is that the overall scaling of  $H$  metric has no effect on physics. What matters is the ratio of Planck constants  $r = \hbar(M^4)/\hbar(CP_2)$  appearing as a scaling factor of  $M^4$  metric. This leaves two options if one requires that the Planck constant defines a homomorphism. The model for dark gravitons suggests a unique choice between these two options but one must keep still mind open for the alternative.
5. Jones inclusions appear as two variants corresponding to  $\mathcal{N} : \mathcal{M} < 4$  and  $\mathcal{N} : \mathcal{M} = 4$ . The tentative interpretation is in terms of singular  $G$ -factor spaces and  $G$ -coverings of  $M^4$  and  $CP_2$  in some sense. The alternative interpretation assigning the inclusions to the two different geodesic spheres of  $CP_2$  would mean asymmetry between  $M^4$  and  $CP_2$  degrees of freedom and is therefore not convincing.
6. The natural question is why the hierarchy of Planck constants is needed. Is it really necessary? Number theoretic Universality suggests that this is the case. One must be able to define the notion of angle -or at least the notion of phase and of trigonometric functions- also in the p-adic context. All that one can achieve naturally is the notion of phase defined as a root of unity and introduced by allowing algebraic extension of p-adic number field by introducing the phase. In the framework of TGD inspired theory of consciousness this inspires a vision about cognitive evolution as the gradual emergence of increasingly complex algebraic extensions of p-adic numbers and involving also the emergence of improved angle resolution expressible in terms of phases  $exp(i2\pi/n)$  up to some maximum value of  $n$ . The coverings and factor spaces would realize these phases purely geometrically and quantum phases  $q$  assignable to Jones inclusions would realize them algebraically. Besides p-adic coupling constant evolution based on the hierarchy of p-adic length scales there would be coupling constant evolution with respect to  $\hbar$  and associated with angular resolution.

### 14.3.3 Hierarchy of Planck constants and the generalization of the notion of imbedding space

In the following the recent view about structure of imbedding space forced by the quantization of Planck constant is summarized. The question is whether it might be possible in some sense to replace  $H$  or its Cartesian factors by their necessarily singular multiple coverings and factor spaces. One can consider two options: either  $M^4$  or the causal diamond  $CD$ . The latter one is the more plausible option from the point of view of WCW geometry.

#### The evolution of physical ideas about hierarchy of Planck constants

The evolution of the physical ideas related to the hierarchy of Planck constants and dark matter as a hierarchy of phases of matter with non-standard value of Planck constants was much faster than the evolution of mathematical ideas and quite a number of applications have been developed during last five years.

1. The starting point was the proposal of Nottale [E23] that the orbits of inner planets correspond to Bohr orbits with Planck constant  $\hbar_{gr} = GMm/v_0$  and outer planets with Planck constant  $\hbar_{gr} = 5GMm/v_0$ ,  $v_0/c \simeq 2^{-11}$ . The basic proposal [K65] was that ordinary matter condenses around dark matter which is a phase of matter characterized by a non-standard value of Planck constant whose value is gigantic for the space-time sheets mediating gravitational interaction. The interpretation of these space-time sheets could be as magnetic flux quanta or as massless extremals assignable to gravitons.

2. Ordinary particles possibly residing at these space-time sheet have enormous value of Compton length meaning that the density of matter at these space-time sheets must be very slowly varying. The string tension of string like objects implies effective negative pressure characterizing dark energy so that the interpretation in terms of dark energy might make sense [K66] . TGD predicted a one-parameter family of Robertson-Walker cosmologies with critical or over-critical mass density and the "pressure" associated with these cosmologies is negative.
3. The quantization of Planck constant does not make sense unless one modifies the view about standard space-time is. Particles with different Planck constant must belong to different worlds in the sense local interactions of particles with different values of  $\hbar$  are not possible. This inspires the idea about the book like structure of the imbedding space obtained by gluing almost copies of  $H$  together along common "back" and partially labeled by different values of Planck constant.
4. Darkness is a relative notion in this framework and due to the fact that particles at different pages of the book like structure cannot appear in the same vertex of the generalized Feynman diagram. The phase transitions in which partonic 2-surface  $X^2$  during its travel along  $X_l^3$  leaks to another page of book are however possible and change Planck constant. Particle (say photon -) exchanges of this kind allow particles at different pages to interact. The interactions are strongly constrained by charge fractionization and are essentially phase transitions involving many particles. Classical interactions are also possible. It might be that we are actually observing dark matter via classical fields all the time and perhaps have even photographed it [?] .
5. The realization that non-standard values of Planck constant give rise to charge and spin fractionization and anyonization led to the precise identification of the prerequisites of anyonic phase [?] . If the partonic 2-surface, which can have even astrophysical size, surrounds the tip of  $CD$ , the matter at the surface is anyonic and particles are confined at this surface. Dark matter could be confined inside this kind of light-like 3-surfaces around which ordinary matter condenses. If the radii of the basic pieces of these nearly spherical anyonic surfaces - glued to a connected structure by flux tubes mediating gravitational interaction - are given by Bohr rules, the findings of Nottale [E23] can be understood. Dark matter would resemble to a high degree matter in black holes replaced in TGD framework by light-like partonic 2-surfaces with a minimum size of order Schwarzschild radius  $r_S$  of order scaled up Planck length  $l_{Pl} = \sqrt{\hbar_{gr}G} = GM$ . Black hole entropy is inversely proportional to  $\hbar$  and predicted to be of order unity so that dramatic modification of the picture about black holes is implied.
6. Perhaps the most fascinating applications are in biology. The anomalous behavior ionic currents through cell membrane (low dissipation, quantal character, no change when the membrane is replaced with artificial one) has a natural explanation in terms of dark supra currents. This leads to a vision about how dark matter and phase transitions changing the value of Planck constant could relate to the basic functions of cell, functioning of DNA and aminoacids, and to the mysteries of bio-catalysis. This leads also a model for EEG interpreted as a communication and control tool of magnetic body containing dark matter and using biological body as motor instrument and sensory receptor. One especially amazing outcome is the emergence of genetic code of vertebrates from the model of dark nuclei as nuclear strings [K44, ?] , [K44] .

### The most general option for the generalized imbedding space

Simple physical arguments pose constraints on the choice of the most general form of the imbedding space.

1. The fundamental group of the space for which one constructs a non-singular covering space or factor space should be non-trivial. This is certainly not possible for  $M^4$ ,  $CD$ ,  $CP_2$ , or  $H$ . One can however construct singular covering spaces. The fixing of the quantization axes implies a selection of the sub-space  $H_4 = M^2 \times S^2 \subset M^4 \times CP_2$ , where  $S^2$  is geodesic sphere of  $CP_2$ .  $\hat{M}^4 = M^4 \setminus M^2$  and  $\hat{CP}_2 = CP_2 \setminus S^2$  have fundamental group  $Z$  since the codimension of the excluded sub-manifold is equal to two and homotopically the situation is like that for a punctured plane. The exclusion of these sub-manifolds defined by the choice of quantization axes could naturally give rise to the desired situation.



2.  $CP_2$  allows two geodesic spheres which left invariant by  $U(2)$  resp.  $SO(3)$ . The first one is homologically non-trivial. For homologically non-trivial geodesic sphere  $H_4 = M^2 \times S^2$  represents a straight cosmic string which is non-vacuum extremal of Kähler action (not necessarily preferred extremal). One can argue that the many-valuedness of  $\hbar$  is un-acceptable for non-vacuum extremals so that only homologically trivial geodesic sphere  $S^2$  would be acceptable. One could go even further. If the extremals in  $M^2 \times CP_2$  can be preferred non-vacuum extremals, the singular coverings of  $M^4$  are not possible. Therefore only the singular coverings and factor spaces of  $CP_2$  over the homologically trivial geodesic sphere  $S^2$  would be possible. This however looks a non-physical outcome.
  - (a) The situation changes if the extremals of type  $M^2 \times Y^2$ ,  $Y^2$  a holomorphic surface of  $CP_3$ , fail to be hyperquaternionic. The tangent space  $M^2$  represents hypercomplex sub-space and the product of the modified gamma matrices associated with the tangent spaces of  $Y^2$  should belong to  $M^2$  algebra. This need not be the case in general.
  - (b) The situation changes also if one reinterprets the gluing procedure by introducing scaled up coordinates for  $M^4$  so that metric is continuous at  $M^2 \times CP_2$  but  $CD$ s with different size have different sizes differing by the ratio of Planck constants and would thus have only piece of lower or upper boundary in common.
3. For the more general option one would have four different options corresponding to the Cartesian products of singular coverings and factor spaces. These options can be denoted by  $C-C$ ,  $C-F$ ,  $F-C$ , and  $F-F$ , where  $C$  ( $F$ ) signifies for covering (factor space) and first (second) letter signifies for  $CD$  ( $CP_2$ ) and correspond to the spaces  $(\hat{C}D \hat{\times} G_a) \times (\hat{C}P_2 \hat{\times} G_b)$ ,  $(\hat{C}D \hat{\times} G_a) \times \hat{C}P_2/G_b$ ,  $\hat{C}D/G_a \times (\hat{C}P_2 \hat{\times} G_b)$ , and  $\hat{C}D/G_a \times \hat{C}P_2/G_b$ .
4. The groups  $G_i$  could correspond to cyclic groups  $Z_n$ . One can also consider an extension by replacing  $M^2$  and  $S^2$  with its orbit under more general group  $G$  (say tetrahedral, octahedral, or icosahedral group). One expects that the discrete subgroups of  $SU(2)$  emerge naturally in this framework if one allows the action of these groups on the singular sub-manifolds  $M^2$  or  $S^2$ . This would replace the singular manifold with a set of its rotated copies in the case that the subgroups have genuinely 3-dimensional action (the subgroups which corresponds to exceptional groups in the ADE correspondence). For instance, in the case of  $M^2$  the quantization axes for angular momentum would be replaced by the set of quantization axes going through the vertices of tetrahedron, octahedron, or icosahedron. This would bring non-commutative homotopy groups into the picture in a natural manner.

### About the phase transitions changing Planck constant

There are several non-trivial questions related to the details of the gluing procedure and phase transition as motion of partonic 2-surface from one sector of the imbedding space to another one.

1. How the gluing of copies of imbedding space at  $M^2 \times CP_2$  takes place? It would seem that the covariant metric of  $CD$  factor proportional to  $\hbar^2$  must be discontinuous at the singular manifold since only in this manner the idea about different scaling factor of  $CD$  metric can make sense. On the other hand, one can always scale the  $M^4$  coordinates so that the metric is continuous but the sizes of  $CD$ s with different Planck constants differ by the ratio of the Planck constants.
2. One might worry whether the phase transition changing Planck constant means an instantaneous change of the size of partonic 2-surface in  $M^4$  degrees of freedom. This is not the case. Light-likeness in  $M^2 \times S^2$  makes sense only for surfaces  $X^1 \times D^2 \subset M^2 \times S^2$ , where  $X^1$  is light-like geodesic. The requirement that the partonic 2-surface  $X^2$  moving from one sector of  $H$  to another one is light-like at  $M^2 \times S^2$  irrespective of the value of Planck constant requires that  $X^2$  has single point of  $M^2$  as  $M^2$  projection. Hence no sudden change of the size  $X^2$  occurs.
3. A natural question is whether the phase transition changing the value of Planck constant can occur purely classically or whether it is analogous to quantum tunneling. Classical non-vacuum extremals of Chern-Simons action have two-dimensional  $CP_2$  projection to homologically non-trivial geodesic sphere  $S^2_I$ . The deformation of the entire  $S^2_I$  to homologically trivial geodesic sphere  $S^2_{II}$  is not possible so that only combinations of partonic 2-surfaces with vanishing total

homology charge (Kähler magnetic charge) can in principle move from sector to another one, and this process involves fusion of these 2-surfaces such that  $CP_2$  projection becomes single homologically trivial 2-surface. A piece of a non-trivial geodesic sphere  $S^2_I$  of  $CP_2$  can be deformed to that of  $S^2_{II}$  using 2-dimensional homotopy flattening the piece of  $S^2$  to curve. If this homotopy cannot be chosen to be light-like, the phase transitions changing Planck constant take place only via quantum tunnelling. Obviously the notions of light-like homotopies (cobordisms) are very relevant for the understanding of phase transitions changing Planck constant.

**How one could fix the spectrum of Planck constants?**

The question how the observed Planck constant relates to the integers  $n_a$  and  $n_b$  defining the covering and factors spaces, is far from trivial and I have considered several options. The basic physical inputs are the condition that scaling of Planck constant must correspond to the scaling of the metric of  $CD$  (that is Compton lengths) on one hand and the scaling of the gauge coupling strength  $g^2/4\pi\hbar$  on the other hand.

1. One can assign to Planck constant to both  $CD$  and  $CP_2$  by assuming that it appears in the commutation relations of corresponding symmetry algebras. Algebraist would argue that Planck constants  $\hbar(CD)$  and  $\hbar(CP_2)$  must define a homomorphism respecting multiplication and division (when possible) by  $G_i$ . This requires  $r(X) = \hbar(X)\hbar_0 = n$  for covering and  $r(X) = 1/n$  for factor space or vice versa.
2. If one assumes that  $\hbar^2(X)$ ,  $X = M^4$ ,  $CP_2$  corresponds to the scaling of the covariant metric tensor  $g_{ij}$  and performs an over-all scaling of  $H$ -metric allowed by the Weyl invariance of Kähler action by dividing metric with  $\hbar^2(CP_2)$ , one obtains the scaling of  $M^4$  covariant metric by  $r^2 \equiv \hbar^2/\hbar_0^2 = \hbar^2(M^4)/\hbar^2(CP_2)$  whereas  $CP_2$  metric is not scaled at all.
3. The condition that  $\hbar$  scales as  $n_a$  is guaranteed if one has  $\hbar(CD) = n_a\hbar_0$ . This does not fix the dependence of  $\hbar(CP_2)$  on  $n_b$  and one could have  $\hbar(CP_2) = n_b\hbar_0$  or  $\hbar(CP_2) = \hbar_0/n_b$ . The intuitive picture is that  $n_b$ - fold covering gives in good approximation rise to  $n_a n_b$  sheets and multiplies YM action action by  $n_a n_b$  which is equivalent with the  $\hbar = n_a n_b \hbar_0$  if one effectively compresses the covering to  $CD \times CP_2$ . One would have  $\hbar(CP_2) = \hbar_0/n_b$  and  $\hbar = n_a n_b \hbar_0$ . Note that the descriptions using ordinary Planck constant and coverings and scaled Planck constant but contracting the covering would be alternative descriptions.

This gives the following formulas  $r \equiv \hbar/\hbar_0 = r(M^4)/r(CP_2)$  in various cases.

$$\begin{array}{ccccc}
 C - C & F - C & C - F & F - F & \\
 \hline
 r & n_a n_b & \frac{n_a}{n_b} & \frac{n_b}{n_a} & \frac{1}{n_a n_b}
 \end{array}$$

**Preferred values of Planck constants**

Number theoretic considerations favor the hypothesis that the integers corresponding to Fermat polygons constructible using only ruler and compass and given as products  $n_F = 2^k \prod_s F_s$ , where  $F_s = 2^{2^s} + 1$  are distinct Fermat primes, are favored. The reason would be that quantum phase  $q = exp(i\pi/n)$  is in this case expressible using only iterated square root operation by starting from rationals. The known Fermat primes correspond to  $s = 0, 1, 2, 3, 4$  so that the hypothesis is very strong and predicts that p-adic length scales have satellite length scales given as multiples of  $n_F$  of fundamental p-adic length scale.  $n_F = 2^{11}$  corresponds in TGD framework to a fundamental constant expressible as a combination of Kähler coupling strength,  $CP_2$  radius and Planck length appearing in the expression for the tension of cosmic strings, and the powers of  $2^{11}$  was proposed to define favored as values of  $n_a$  in living matter [K22].

The hypothesis that Mersenne primes  $M_k = 2^k - 1$ ,  $k \in \{89, 107, 127\}$ , and Gaussian Mersennes  $M_{G,k} = (1 + i)k - 1$ ,  $k \in \{113, 151, 157, 163, 167, 239, 241.. \}$  (the number theoretical miracle is that all the four p-adic length scales with  $k \in \{151, 157, 163, 167\}$  are in the biologically highly interesting range 10 nm-2.5  $\mu$ m) define scaled up copies of electro-weak and QCD type physics with ordinary value of  $\hbar$  and that these physics are induced by dark variants of corresponding lower level physics leads to a prediction for the preferred values of  $r = 2^{k_d}$ ,  $k_d = k_i - k_j$ , and the resulting picture finds

support from the ensuing models for biological evolution and for EEG [K22]. This hypothesis - to be referred to as Mersenne hypothesis - replaces the rather ad hoc proposal  $r = \hbar/\hbar_0 = 2^{11k}$  for the preferred values of Planck constant.

#### How Planck constants are visible in Kähler action?

$\hbar(M^4)$  and  $\hbar(CP_2)$  appear in the commutation and anticommutation relations of various superconformal algebras. Only the ratio of  $M^4$  and  $CP_2$  Planck constants appears in Kähler action and is due to the fact that the  $M^4$  and  $CP_2$  metrics of the imbedding space sector with given values of Planck constants are proportional to the corresponding Planck. This implies that Kähler function codes for radiative corrections to the classical action, which makes possible to consider the possibility that higher order radiative corrections to functional integral vanish as one might expect at quantum criticality. For a given p-adic length scale space-time sheets with all allowed values of Planck constants are possible. Hence the spectrum of quantum critical fluctuations could in the ideal case correspond to the spectrum of  $\hbar$  coding for the scaled up values of Compton lengths and other quantal lengths and times. If so, large  $\hbar$  phases could be crucial for understanding of quantum critical superconductors, in particular high  $T_c$  superconductors.

## 14.4 Updated view about the hierarchy of Planck constants

During last years the work with TGD proper has transformed from the discovery of brave visions to the work of clock smith. The challenge is to fill in the details, to define various notions more precisely, and to eliminate the numerous inconsistencies.

Few years has passed from the latest formulation for the hierarchy of Planck constant. The original hypothesis was that the hierarchy is real. In this formulation the imbedding space was replaced with its covering space assumed to decompose to a Cartesian product of singular finite-sheeted coverings of  $M^4$  and  $CP_2$ .

Few years ago came the realization that it could be only effective but have same practical implications. The basic observation was that the effective hierarchy need not be postulated separately but follows as a prediction from the vacuum degeneracy of Kähler action. In this formulation Planck constant at fundamental level has its standard value and its effective values come as its integer multiples so that one should write  $\hbar_{eff} = n\hbar$  rather than  $\hbar = n\hbar_0$  as I have done. For most practical purposes the states in question would behave as if Planck constant were an integer multiple of the ordinary one. It was no more necessary to assume that the covering reduces to a Cartesian product of singular coverings of  $M^4$  and  $CP_2$  but for some reason I kept this assumption.

It seems that the time is ripe for checking whether some polishing of this formulation might be needed. In particular, the work with TGD inspired quantum biology suggests a close connection between the hierarchy of Planck constants and negentropic entanglement. Also the connection with anyons and charge fractionalization has remained somewhat fuzzy [?]. In particular, it seems that the formulation based on multi-furcations of space-time surfaces to  $N$  branches is not general enough: the  $N$  branches are very much analogous to single particle states and second quantization allowing all  $0 < n \leq N$ -particle states for given  $N$  rather than only  $N$ -particle states looks very natural: as a matter fact, this interpretation was the original one and led to the very speculative and fuzzy notion of  $N$ -atom, which I later more or less gave up. Quantum multi-furcation could be the root concept implying the effective hierarchy of Planck constants, anyons and fractional charges, and related notions- even the notions of  $N$ -nuclei,  $N$ -atoms, and  $N$ -molecules.

### 14.4.1 Basic physical ideas

The basic phenomenological rules are simple and there is no need to modify them.

1. The phases with non-standard values of effective Planck constant are identified as dark matter. The motivation comes from the natural assumption that only the particles with the same value of effective Planck can appear in the same vertex. One can illustrate the situation in terms of the book metaphor. Imbedding spaces with different values of Planck constant form a book like structure and matter can be transferred between different pages only through the back of the book where the pages are glued together. One important implication is that light exotic

charged particles lighter than weak bosons are possible if they have non-standard value of Planck constant. The standard argument excluding them is based on decay widths of weak bosons and has led to a neglect of large number of particle physics anomalies [?].

2. Large effective or real value of Planck constant scales up Compton length - or at least de Broglie wave length - and its geometric correlate at space-time level identified as size scale of the space-time sheet assignable to the particle. This could correspond to the Kähler magnetic flux tube for the particle forming consisting of two flux tubes at parallel space-time sheets and short flux tubes at ends with length of order  $CP_2$  size.

This rule has far reaching implications in quantum biology and neuroscience since macroscopic quantum phases become possible as the basic criterion stating that macroscopic quantum phase becomes possible if the density of particles is so high that particles as Compton length sized objects overlap. Dark matter therefore forms macroscopic quantum phases. One implication is the explanation of mysterious looking quantal effects of ELF radiation in EEG frequency range on vertebrate brain:  $E = hf$  implies that the energies for the ordinary value of Planck constant are much below the thermal threshold but large value of Planck constant changes the situation. Also the phase transitions modifying the value of Planck constant and changing the lengths of flux tubes (by quantum classical correspondence) are crucial as also reconnections of the flux tubes.

The hierarchy of Planck constants suggests also a new interpretation for FQHE (fractional quantum Hall effect) [?] in terms of anyonic phases with non-standard value of effective Planck constant realized in terms of the effective multi-sheeted covering of imbedding space: multi-sheeted space-time is to be distinguished from many-sheeted space-time.

3. In astrophysics and cosmology the implications are even more dramatic if one believes that also  $\hbar_{gr}$  corresponds to effective Planck constant interpreted as number of sheets of multi-furcation. It was Nottale [E23] who first introduced the notion of gravitational Planck constant as  $\hbar_{gr} = GMm/v_0$ ,  $v_0 < 1$  has interpretation as velocity light parameter in units  $c = 1$ . This would be true for  $GMm/v_0 \geq 1$ . The interpretation of  $\hbar_{gr}$  in TGD framework is as an effective Planck constant associated with space-time sheets mediating gravitational interaction between masses  $M$  and  $m$ . The huge value of  $\hbar_{gr}$  means that the integer  $\hbar_{gr}/\hbar_0$  interpreted as the number of sheets of covering is gigantic and that Universe possesses gravitational quantum coherence in super-astronomical scales for masses which are large. This would suggest that gravitational radiation is emitted as dark gravitons which decay to pulses of ordinary gravitons replacing continuous flow of gravitational radiation.

It must be however emphasized that the interpretation of  $\hbar_{gr}$  could be different, and it will be found that one can develop an argument demonstrating how  $\hbar_{gr}$  with a correct order of magnitude emerges from the effective space-time metric defined by the anticommutators appearing in the modified Dirac equation.

4. Why Nature would like to have large effective value of Planck constant? A possible answer relies on the observation that in perturbation theory the expansion takes in powers of gauge couplings strengths  $\alpha = g^2/4\pi\hbar$ . If the effective value of  $\hbar$  replaces its real value as one might expect to happen for multi-sheeted particles behaving like single particle,  $\alpha$  is scaled down and perturbative expansion converges for the new particles. One could say that Mother Nature loves theoreticians and comes in rescue in their attempts to calculate. In quantum gravitation the problem is especially acute since the dimensionless parameter  $GMm/\hbar$  has gigantic value. Replacing  $\hbar$  with  $\hbar_{gr} = GMm/v_0$  the coupling strength becomes  $v_0 < 1$ .

#### 14.4.2 Space-time correlates for the hierarchy of Planck constants

The hierarchy of Planck constants was introduced to TGD originally as an additional postulate and formulated as the existence of a hierarchy of imbedding spaces defined as Cartesian products of singular coverings of  $M^4$  and  $CP_2$  with numbers of sheets given by integers  $n_a$  and  $n_b$  and  $\hbar = n\hbar_0$ .  $n = n_a n_b$ .

With the advent of zero energy ontology, it became clear that the notion of singular covering space of the imbedding space could be only a convenient auxiliary notion. Singular means that the sheets fuse together at the boundary of multi-sheeted region. The effective covering space emerges naturally

from the vacuum degeneracy of Kähler action meaning that all deformations of canonically imbedded  $M^4$  in  $M^4 \times CP_2$  have vanishing action up to fourth order in small perturbation. This is clear from the fact that the induced Kähler form is quadratic in the gradients of  $CP_2$  coordinates and Kähler action is essentially Maxwell action for the induced Kähler form. The vacuum degeneracy implies that the correspondence between canonical momentum currents  $\partial L_K / \partial(\partial_\alpha h^k)$  defining the modified gamma matrices [?] and gradients  $\partial_\alpha h^k$  is not one-to-one. Same canonical momentum current corresponds to several values of gradients of imbedding space coordinates. At the partonic 2-surfaces at the light-like boundaries of  $CD$  carrying the elementary particle quantum numbers this implies that the two normal derivatives of  $h^k$  are many-valued functions of canonical momentum currents in normal directions.

Multi-furcation is in question and multi-furcations are indeed generic in highly non-linear systems and Kähler action is an extreme example about non-linear system. What multi-furcation means in quantum theory? The branches of multi-furcation are obviously analogous to single particle states. In quantum theory second quantization means that one constructs not only single particle states but also the many particle states formed from them. At space-time level single particle states would correspond to  $N$  branches  $b_i$  of multi-furcation carrying fermion number. Two-particle states would correspond to 2-fold covering consisting of 2 branches  $b_i$  and  $b_j$  of multi-furcation.  $N$ -particle state would correspond to  $N$ -sheeted covering with all branches present and carrying elementary particle quantum numbers. The branches co-incide at the partonic 2-surface but since their normal space data are different they correspond to different tensor product factors of state space. Also now the factorization  $N = n_a n_b$  occurs but now  $n_a$  and  $n_b$  would relate to branching in the direction of space-like 3-surface and light-like 3-surface rather than  $M^4$  and  $CP_2$  as in the original hypothesis.

In light of this the working hypothesis adopted during last years has been too limited: for some reason I ended up to propose that only  $N$ -sheeted covering corresponding to a situation in which all  $N$  branches are present is possible. Before that I quite correctly considered more general option based on intuition that one has many-particle states in the multi-sheeted space. The erratic form of the working hypothesis has not been used in applications.

Multi-furcations relate closely to the quantum criticality of Kähler action. Feigenbaum bifurcations represent a toy example of a system which via successive bifurcations approaches chaos. Now more general multi-furcations in which each branch of given multi-furcation can multi-furcate further, are possible unless one poses any additional conditions. This allows to identify additional aspect of the geometric arrow of time. Either the positive or negative energy part of the zero energy state is "prepared" meaning that single  $n$ -sub-furcations of  $N$ -furcation is selected. The most general state of this kind involves superposition of various  $n$ -sub-furcations.

### 14.4.3 Basic phenomenological rules of thumb in the new framework

It is important to check whether or not the refreshed view about dark matter is consistent with existent rules of thumb.

1. The interpretation of quantized multi-furcations as WCW anyons explains also why the effective hierarchy of Planck constants defines a hierarchy of phases which are dark relative to each other. This is trivially true since the phases with different number of branches in multi-furcation correspond to disjoint regions of WCW so that the particles with different effective value of Planck constant cannot appear in the same vertex.
2. The phase transitions changing the value of Planck constant are just the multi-furcations and can be induced by changing the values of the external parameters controlling the properties of preferred extremals. Situation is very much the same as in any non-linear system.
3. In the case of massless particles the scaling of wavelength in the effective scaling of  $\hbar$  can be understood if dark  $n$ -photons consist of  $n$  photons with energy  $E/n$  and wavelength  $n\lambda$ .
4. For massive particle it has been assumed that masses for particles and their dark counterparts are same and Compton wavelength is scaled up. In the new picture this need not be true. Rather, it would seem that wave length are same as for ordinary electron.

On the other hand, p-adic thermodynamics predicts that massive elementary particles are massless most of the time. ZEO predicts that even virtual wormhole throats are massless. Could this mean that the picture applying on massless particle should apply to them at least at

relativistic limit at which mass is negligible. This might be the case for bosons but for fermions also fermion number should be fractionalized and this is not possible in the recent picture. If one assumes that the  $n$ -electron has same mass as electron, the mass for dark single electron state would be scaled down by  $1/n$ . This does not look sensible unless the p-adic length defined by prime is scaled down by this fact in good approximation.

This suggests that for fermions the basic scaling rule does not hold true for Compton length  $\lambda_c = \hbar/m$ . Could it however hold for de-Broglie lengths  $\lambda = \hbar/p$  defined in terms of 3-momentum? The basic overlap rule for the formation of macroscopic quantum states is indeed formulated for de Broglie wave length. One could argue that an  $1/N$ -fold reduction of density that takes place in the delocalization of the single particle states to the  $N$  branches of the cover, implies that the volume per particle increases by a factor  $N$  and single particle wave function is delocalized in a larger region of 3-space. If the particles reside at effectively one-dimensional 3-surfaces - say magnetic flux tubes - this would increase their de Broglie wave length in the direction of the flux tube and also the length of the flux tube. This seems to be enough for various applications.

One important notion in TGD inspired quantum biology is dark cyclotron state.

1. The scaling  $\hbar \rightarrow k\hbar$  in the formula  $E_n = (n + 1/2)\hbar eB/m$  implies that cyclotron energies are scaled up for dark cyclotron states. What this means microscopically has not been obvious but the recent picture gives a rather clearcut answer. One would have  $k$ -particle state formed from cyclotron states in  $N$ -fold branched cover of space-time surface. Each branch would carry magnetic field  $B$  and ion or electron. This would give a total cyclotron energy equal to  $kE_n$ . These cyclotron states would be excited by  $k$ -photons with total energy  $E = khf$  and for large enough value of  $k$  the energies involved would be above thermal threshold. In the case of  $Ca^{++}$  one has  $f = 15$  Hz in the field  $B_{end} = .2$  Gauss. This means that the value of  $\hbar$  is at least the ratio of thermal energy at room temperature to  $E = hf$ . The thermal frequency is of order  $10^{12}$  Hz so that one would have  $k \simeq 10^{11}$ . The number branches would be therefore rather high.
2. It seems that this kinds of states which I have called cyclotron Bose-Einstein condensates could make sense also for fermions. The dark photons involved would be Bose-Einstein condensates of  $k$  photons and wall of them would be simultaneously absorbed. The biological meaning of this would be that a simultaneous excitation of large number of atoms or molecules can take place if they are localized at the branches of  $N$ -furcation. This would make possible coherent macroscopic changes. Note that also Cooper pairs of electrons could be  $n = 2$ -particle states associated with  $N$ -furcation.

There are experimental findings suggesting that photosynthesis involves delocalized excitations of electrons and it is interesting to see whether this could be understood in this framework.

1. The TGD based model relies on the assumption that cyclotron states are involved and that dark photons with the energy of visible photons but with much longer wavelength are involved. Single electron excitations (or single particle excitations of Cooper pairs) would generate negentropic entanglement automatically.
2. If cyclotron excitations are the primary ones, it would seem that they could be induced by dark  $n$ -photons exciting all  $n$  electrons simultaneously.  $n$ -photon should have energy of a visible photon. The number of cyclotron excited electrons should be rather large if the total excitation energy is to be above thermal threshold. In this case one could not speak about cyclotron excitation however. This would require that solar photons are transformed to  $n$ -photons in  $N$ -furcation in biosphere.
3. Second - more realistic looking - possibility is that the incoming photons have energy of visible photon and are therefore  $n = 1$  dark photons delocalized to the branches of the  $N$ -furcation. They would induce delocalized single electron excitation in WCW rather than 3-space.

#### 14.4.4 Charge fractionalization and anyons

It is easy to see how the effective value of Planck constant as an integer multiple of its standard value emerges for multi-sheeted states in second quantization. At the level of Kähler action one can assume

that in the first approximation the value of Kähler action for each branch is same so that the total Kähler action is multiplied by  $n$ . This corresponds effectively to the scaling  $\alpha_K \rightarrow \alpha_K/n$  induced by the scaling  $\hbar_0 \rightarrow n\hbar_0$ .

Also effective charge fractionalization and anyons emerge naturally in this framework.

1. In the ordinary charge fractionalization the wave function decomposes into sharply localized pieces around different points of 3-space carrying fractional charges summing up to integer charge. Now the same happens at the level of WCW ("world of classical worlds") rather than 3-space meaning that wave functions in  $E^3$  are replaced with wave functions in the space-time of 3-surfaces (4-surfaces by holography implied by General Coordinate Invariance) replacing point-like particles. Single particle wave function in WCW is a sum of  $N$  sharply localized contributions: localization takes place around one particular branch of the multi-sheeted space time surface. Each branch carries a fractional charge  $q/N$  for teh analogs of plane waves.

Therefore all quantum numbers are additive and fractionalization is only effective and observable in a localization of wave function to single branch occurring with probability  $p = 1/N$  from which one can deduce that charge is  $q/N$ .

2. The is consistent with the proposed interpretation of dark photons/gravitons since they could carry large spin and this kind of situation could decay to bunches of ordinary photons/gravitons. It is also consistent with electromagnetic charge fractionalization and fractionalization of spin.
3. The original - and it seems wrong - argument suggested what might be interpreted as a genuine fractionalization for orbital angular momentum and also of color quantum numbers, which are analogous to orbital angular momentum in TGD framework. The observation was that a rotation through  $2\pi$  at space-time level moving the point along space-time surface leads to a new branch of multi-furcation and  $N + 1$ :th branch corresponds to the original one. This suggests that angular momentum fractionalization should take place for  $M^4$  angle coordinate  $\phi$  because for it  $2\pi$  rotation could lead to a different sheet of the effective covering.

The orbital angular momentum eigenstates would correspond to waves  $\exp(i\phi m/N)$ ,  $m = 0, 2, \dots, N-1$  and the maximum orbital angular momentum would correspond the sum  $\sum_{m=0}^{N-1} m/N = (N-1)/2$ . The sum of spin and orbital angular momentum be therefore fractional.

The different prediction is due to the fact that rotations are now interpreted as flows rotating the points of 3-surface along 3-surface rather than rotations of the entire partonic surface in imbedding space. In the latter interpretation the rotation by  $2\pi$  does nothing for the 3-surface. Hence fractionalization for the total charge of the single particle states does not take place unless one adopts the flow interpretation. This view about fractionalization however leads to problems with fractionalization of electromagnetic charge and spin for which there is evidence from fractional quantum Hall effect.

#### 14.4.5 Negentropic entanglement between branches of multi-furcations

The application of negentropic entanglement and effective hierarchy of Planck constants to photosynthesis and metabolism [K33] suggests that these two notions might be closely related. Negentropic entanglement is possible for rational (and even algebraic) entanglement probabilities. If one allows number theoretic variant of Shannon entropy based on the p-adic norm for the probability appearing as argument of logarithm [K42], it is quite possible to have negative entanglement entropy and the interpretation is as genuine information carried by entanglement. The superposition of state pairs  $a_i \otimes b_i$  in entangled state would represent instances of a rule. In the case of Schrödinger cat the rule states that it is better to not open the bottle: understanding the rule consciously however requires that cat is somewhat dead! Entanglement provides information about the relationship between two systems. Shannon entropy represents lack of information about single particle state.

Negentropic entanglement would replace metabolic energy as the basic quantity making life possible. Metabolic energy could generate negentropic entanglement by exciting biomolecules to negentropically entangled states. ATP providing the energy for generating the metabolic entanglement could also itself carry negentropic entanglement, and transfer it to the target by the emission of large  $\hbar$  photons.

How the large  $\hbar$  photons could carry negentropic entanglement?

1. In zero energy ontology large  $\hbar$  photons could carry the negentropic entanglement as entanglement between positive and negative energy parts of the photon state.
2. The negentropic entanglement of large  $\hbar$  photon could be also associated with its positive or energy part or both. Large  $\hbar_{eff} = n\hbar$  photon with  $n$ -fold energy  $E = n \times hf$  is  $n$ -sheeted structure consisting of  $n$ -photons with energy  $E = hf$  delocalized in the discrete space formed by the  $N$  space-time sheets. The  $n$  single photon states can entangle and since the branches effectively form a discrete space, rational and algebraic entanglement is very natural. There are many options for how this could happen. For instance, for  $N$ -fold branching the superposition of all  $N!/(N-n)!n!$  states obtained by selecting  $n$  branches are possible and the resulting state is entangled state. If this interpretation is correct, the vacuum degeneracy and multi-furcations implied by it would be the quintessence of life.
3. The identification of negentropic entanglement as entanglement between branches of a multi-furcation is not the only possible option. The proposal is that non-localized single particle excitations of cyclotron condensate at magnetic flux tubes give rise to negentropic entanglement relevant to living matter. Dark photons could transfer the negentropic entanglement possibly assignable to electron pairs of ATP molecule.
4. The negentropic entanglement associated with cyclotron condensate could be associated with the branches of the large  $\hbar$  variant of the condensate. In this case single particle excitation would not be sum of single particle excitations at various positions of 3-space but at various sheet of covering representing points of WCW. If each of the  $n$  branches carries  $1/n$ :th part of electron one would have an anyonic state in WCW.
5. One can also make a really crazy question. Could it be that ATP and various bio-molecules form  $n$ -particle states at the  $n$ -sheet of  $N$ -furcations and that the bio-chemistry involves simultaneous reactions of large numbers of biomolecules at these sheets? If so, the chemical reactions would take place as large number of copies.

Note that in this picture the breaking of time reversal symmetry [?] in the presence of metabolic energy feed would be accompanied by evolution involving repeated multi-furcations leading to increased complexity. TGD based view about the arrow of time implies that for a given  $CD$  this evolution has definite direction of time. At the level of ensemble it implies second law but at the level of individual system means increasing complexity.

#### 14.4.6 Dark variants of nuclear and atomic physics

During years I have in rather speculative spirit considered the possibility of dark variants of nuclear and atomic - and perhaps even molecular physics. Also the notion of dark cyclotron state is central in the quantum model of living matter. One such notion is the idea that dark nucleons could realize vertebrate genetic code [K78].

Before the real understanding what charge fractionalization means it was possible to imagine several variants of say dark atoms depending on whether both nuclei and electrons are dark or whether only electrons are dark and genuinely fractionally charged. The recent picture however fixes these notions completely. Basic building bricks are just ordinary nuclei and atoms and they form  $n$ -particle states associated with  $n$ -branches of  $N$ -furcation with  $n = 1, \dots, N$ . The fractionalization for a single particle state delocalized completely to the discrete space of  $N$  branches as the analog of plane wave means that single branch carries charge  $1/N$ .

The new element is the possibility of  $n$ -particle states populating  $n$  branches of the  $N$ -furcation: note that there is superposition over the states corresponding to different selections of these  $n$  branches.  $N-k$  and  $k$ -nuclei/atoms are in sense conjugates of each other and they can fuse to form  $N$ -nuclei/ $N$ -atoms which in fermionic case are analogous to Fermi sea with all states filled.

Bio-molecules seem to obey symbolic dynamics which does not depend much on the chemical properties: this has motivated various linguistic metaphors applied in bio-chemistry to describe the interactions between DNA and related molecules. This motivated the wild speculation was that  $N$ -atoms and even  $N$ -molecules could make possible the emergence of symbolic representations with  $n \leq N$  serving as a name of atom/molecule and that  $k$ - and  $N-k$  atom/molecule would be analogous



to opposite sexes in that there would be strong tendency for them to fuse together to form  $N$ -atom/-molecule. For instance, in bio-catalysis  $k$ - and  $N - k$ -atoms/molecules would be paired. The recent picture about  $n$  and  $N - k$  atoms seems to be consistent with these speculations which I had already given up as too crazy. It is difficult to avoid even the speculation that bio-chemistry could replace chemical reactions with their  $n$ -multiples. Synchronized quantum jumps would allow to avoid the disastrous effects of state function reductions on quantum coherence. The second manner to say the same thing is that the effective value of Planck constant is large.

#### 14.4.7 What about the relationship of gravitational Planck constant to ordinary Planck constant?

Gravitational Planck constant is given by the expression  $\hbar_{gr} = GMm/v_0$ , where  $v_0 < 1$  has interpretation as velocity parameter in the units  $c = 1$ . Can one interpret also  $\hbar_{gr}$  as effective value of Planck constant so that its values would correspond to multifurcation with a gigantic number of sheets. This does not look reasonable.

Could one imagine any other interpretation for  $\hbar_{gr}$ ? Could the two Planck constants correspond to inertial and gravitational dichotomy for four-momenta making sense also for angular momentum identified as a four-vector? Could gravitational angular momentum and the momentum associated with the flux tubes mediating gravitational interaction be quantized in units of  $\hbar_{gr}$  naturally?

1. Gravitational four-momentum can be defined as a projection of the  $M^4$ -four-momentum to space-time surface. Its length can be naturally defined by the effective metric  $g_{eff}^{\alpha\beta}$  defined by the anticommutators of the modified gamma matrices. Gravitational four-momentum appears as a measurement interaction term in the modified Dirac action and can be restricted to the space-like boundaries of the space-time surface at the ends of  $CD$  and to the light-like orbits of the wormhole throats and which induced 4- metric is effectively 3-dimensional.
2. At the string world sheets and partonic 2-surfaces the effective metric degenerates to 2-D one. At the ends of braid strands representing their intersection, the metric is effectively 4-D. Just for definiteness assume that the effective metric is proportional to the  $M^4$  metric or rather - to its  $M^2$  projection:  $g_{eff}^{kl} = K^2 m^{kl}$ .

One can express the length squared for momentum at the flux tubes mediating the gravitational interaction between massive objects with masses  $M$  and  $m$  as

$$g_{eff}^{\alpha\beta} p_\alpha p_\beta = g_{eff}^{\alpha\beta} \partial_\alpha h^k \partial_\beta h^l p_k p_l \equiv g_{eff}^{kl} p_k p_l = n^2 \frac{\hbar^2}{L^2} . \quad (14.4.1)$$

Here  $L$  would correspond to the length of the flux tube mediating gravitational interaction and  $p_k$  would be the momentum flowing in that flux tube.  $g_{eff}^{kl} = K^2 m^{kl}$  would give

$$p^2 = \frac{n^2 \hbar^2}{K^2 L^2} .$$

$\hbar_{gr}$  could be identified in this simplified situation as  $\hbar_{gr} = \hbar/K$ .

3. Nottale's proposal requires  $K = GMm/v_0$  for the space-time sheets mediating gravitational interacting between massive objects with masses  $M$  and  $m$ . This gives the estimate

$$p_{gr} = \frac{GMm}{v_0} \frac{1}{L} . \quad (14.4.2)$$

For  $v_0 = 1$  this is of the same order of magnitude as the exchanged momentum if gravitational potential gives estimate for its magnitude.  $v_0$  is of same order of magnitude as the rotation velocity of planet around Sun so that the reduction of  $v_0$  to  $v_0 \simeq 2^{-11}$  in the case of inner planets does not mean that the propagation velocity of gravitons is reduced.

4. Nottale's formula requires that the order of magnitude for the components of the energy momentum tensor at the ends of braid strands at partonic 2-surface should have value  $GMm/v_0$ . Einstein's equations  $T = \kappa G + \Lambda g$  give a further constraint. For the vacuum solutions of Einstein's equations with a vanishing cosmological constant the value of  $h_{gr}$  approaches infinity. At the flux tubes mediating gravitational interaction one expects  $T$  to be proportional to the factor  $GMm$  simply because they mediate the gravitational interaction.
5. One can consider similar equation for gravitational angular momentum:

$$g_{eff}^{\alpha\beta} L_\alpha L_\beta = g_{eff}^{kl} L_k L_l = l(l+1)\hbar^2 . \quad (14.4.3)$$

This would give under the same simplifying assumptions

$$L^2 = l(l+1) \frac{\hbar^2}{K^2} . \quad (14.4.4)$$

This would justify the Bohr quantization rule for the angular momentum used in the Bohr quantization of planetary orbits.

One might counter argue that if gravitational 4-momentum square is proportional to inertial 4-momentum squared, then Equivalence Principle implies that  $h_{gr}$  can have only single value. In ZEO however all wormhole throats - also virtual - are massless and the argument fails. The varying  $h_{gr}$  can be assigned only with longitudinal and transversal momentum squared separately but not to the ratio of gravitational and inertial 4-momenta squared which both vanish.

Maybe the proposed connection might make sense in some more refined formulation. In particular the proportionality between  $m_{eff}^{kl} = Km^{kl}$  could make sense as a quantum average. Also the fact, that the constant  $v_0$  varies, could be understood from the dynamical character of  $m_{eff}^{kl}$ .

#### 14.4.8 How the effective hierarchy of Planck constants could reveal itself in condensed matter physics

Anderson - one of the gurus of condensed matter physics - has stated that there exists no theory of condensed matter: experiments produce repeatedly surprises and theoreticians do their best to explain them in the framework of existing quantum theory.

This suggests that condensed matter physics might allow room even for new physics. Indeed, the model for fractional quantum Hall effect (FQHE) [?] strengthened the feeling that the many-sheeted physics of TGD could play a key role in condensed matter physics often thought to be a closed chapter in physics. One implication would be that space-time regions with Euclidian signature of the induced metric would represent the space-time sheet assignable to condensed matter object as a whole as analog of a line of a generalized Feynman diagram. Also the hierarchy of effective Planck constants  $\hbar_{eff} = n\hbar$  appears in the model of FQHE.

The recent discussion of possibility of quantum description of psychokinesis [?] boils down to a model for intentional action based on the notion of magnetic flux tube carrying dark matter and dark photons and inducing macroscopic quantum superpositions of magnetic bubbles of ferromagnet with opposite magnetization. As a by-product the model leads to the proposal that the conduction electrons responsible for ferromagnetism are actually dark (in the sense of having large value of effective Planck constant) and assignable to a multi-sheeted singular covering of space-time sheet assignable to second quantization multifurcation of the preferred extremal of Kähler action made possible by its huge vacuum degeneracy.

What might be the signatures for  $\hbar_{eff} = n\hbar$  states in condensed matter physics and could one interpret some exotic phenomena of condensed matter physics in terms of these states for electrons?

1. The basic signature for the many-electron states associated with multi-sheeted covering is a sharp peak in the density of states due to the presence of new degrees of freedom. In ferromagnets this kind of sharp peak is indeed observed at Fermi energy [?].

2. In the theory of super-conductivity Cooper pairs are identified as bosons. In TGD framework all bosons - also photons - emerge as wormhole contacts with throats carrying fermion and antifermion. I have always felt uneasy with the assumption that two-fermion states obey exact Bose-Einstein statistics at the level of oscillator operators: they are after all two-fermion states. The sheets of multi-sheeted covering resulting in a multifurcation could however carry both photons identified as fermion-antifermion pairs and Cooper pairs and this could naturally give rise to Bose-Einstein statistics in strong sense and also be involved with Bose-Einstein condensates. The maximum number of photons/Cooper pairs in the Bose-Einstein condensate would be given by the number of sheets. Note that in zero energy ontology also the counterparts of coherent states of Cooper pairs are possible: in positive energy ontology they have ill-defined fermion number and also this has made me feel uneasy.

3. Majorana fermions [?] have become one of the hot topics of condensed matter physics recently.

- (a) Majorana particles are actually quasiparticles which can be said to be half-electrons and half-holes. In the language of anyons would have charge fractionization  $e \rightarrow e/2$ . The oscillator operator  $a^\dagger(E)$  creating the hole with energy  $E$  defined as the difference of real energy and Fermi energy equals to the annihilation operator  $a(-E)$  creating a hole:  $a^\dagger(E) = a(-E)$ . If the energy of excitation is  $E = 0$  one obtains  $a^\dagger(0) = a(-0)$ .

Since oscillator operators generate a Clifford algebra just like gamma matrices do, one can argue that one has Majorana fermions at the level of Fock space rather than at the level of spinors. Note that one cannot define Fock vacuum as a state annihilated by  $a(0)$ . Since the creation of particle generates a hole equal to particle for  $E = 0$ , Majorana particles come always in pairs. A fusion of two Majorana particles produces an ordinary fermion.

- (b) Purely mathematically Majorana fermion as a quasiparticle would be highly analogous to covariantly constant right-handed neutrino spinor in TGD with vanishing four-momentum. Note that right-handed neutrino allows 4-dimensional modes as a solution of the modified Dirac equation whereas other spinor modes localized to partonic 2-surfaces and string world sheets. The recent view is however that covariantly constant right-handed neutrino cannot not give rise to the TGD counterpart of standard space-time SUSY.
- (c) In TGD framework the description that suggests itself is in terms of bifurcation of space-time sheet. Charge  $-e/2$  states would be electrons delocalized to two sheets. Charge fractionization would occur in the sense that both sheets would carry charge  $-e/2$ . Bifurcation could also carry two electrons giving charge  $-e$  at both sheets. Two-sheeted analog of Cooper pair would be in question. Ordinary Cooper pair would in turn be localized in single sheet of a multifurcation. The two-sheeted analog of Cooper pair could be regarded as a pair of Majorana particles if the measured charge of electron corresponds to its charge at single sheet of bifurcation (this assumption made also in the case of FQHE is crucial!). Whether this is the case, remains unclear to me.
- (d) Fractional Josephson effect in which the current carriers of Josephson current become electrons or quasiparticles with the quantum numbers of electron has been suggested to serve as a signature of Majorana quasiparticles [?]. An explanation consistent with above assumption is as a two-sheeted analog of Cooper pair associated with a bifurcated space-time sheets.

If the measurements of Josephson current measure the current associated with single branch of bifurcation the unit of Josephson current is indeed halved from  $-2e$  to  $-e$ . These 2-sheeted Cooper pairs behave like dark matter with respect to ordinary matter so that dissipation free current flow would become possible.

Note that ordinary Cooper pair Bose-Einstein condensate would correspond to  $N$ -furcation with  $N$  identified as the number of Cooper pairs in the condensate if the above speculation is correct. Fractional Josephson effect generated in external field would correspond to a formation of mini Bose-Einstein condensates in this framework and also smaller fractional charges are expected. In this case the interpretation as Majorana fermion does not seem to make sense.

### 14.4.9 Summary

The hierarchy of Planck constants reduces to second quantization of multi-furcations in TGD framework and the hierarchy is only effective. Anyonic physics and effective charge fractionalization are consequences of second quantized multi-furcations. This framework also provides quantum version for the transition to chaos via quantum multi-furcations and living matter represents the basic application. The key element of dynamics of TGD is vacuum degeneracy of Kähler action making possible quantum criticality having the hierarchy of multi-furcations as basic aspect. The potential problems relate to the question whether the effective scaling of Planck constant involves scaling of ordinary wavelength or not. For particles confined inside linear structures such as magnetic flux tubes this seems to be the case.

There is also an intriguing connection with the vision about physics as generalized number theory. The conjecture that the preferred extremals of Kähler action consist of quaternionic or co-quaternionic regions led to a construction of them using iteration and also led to the hierarchy of multi-furcations [?]. Therefore it seems that the dynamics of preferred extremals might indeed reduce to associativity/co-associativity condition at space-time level, to commutativity/co-commutativity condition at the level of string world sheets and partonic 2-surfaces, and to reality at the level of stringy curves (conformal invariance makes stringy curves causal determinants [?] so that conformal dynamics represents conformal evolution) [K72].

## 14.5 Vision about dark matter as phases with non-standard value of Planck constant

### 14.5.1 Dark rules

It is useful to summarize the basic phenomenological view about dark matter.

#### The notion of relative darkness

The essential difference between TGD and more conventional models of dark matter is that darkness is only relative concept.

1. Generalized imbedding space forms a book like structure and particles at different pages of the book are dark relative to each other since they cannot appear in the same vertex identified as the partonic 2-surface along which light-like 3-surfaces representing the lines of generalized Feynman diagram meet.
2. Particles at different space-time sheets act via classical gauge field and gravitational field and can also exchange gauge bosons and gravitons (as also fermions) provided these particles can leak from page to another. This means that dark matter can be even photographed [?] . This interpretation is crucial for the model of living matter based on the assumption that dark matter at magnetic body controls matter visible to us. Dark matter can also suffer a phase transition to visible matter by leaking between the pages of the Big Book.
3. The notion of standard value  $\hbar_0$  of  $\hbar$  is not a relative concept in the sense that it corresponds to rational  $r = 1$ . In particular, the situation in which both  $CD$  and  $CP_2$  correspond to trivial coverings and factor spaces would naturally correspond to standard physics.

#### Is dark matter anyonic?

In [?] a detailed model for the Kähler structure of the generalized imbedding space is constructed. What makes this model non-trivial is the possibility that  $CP_2$  Kähler form can have gauge parts which would be excluded in full imbedding space but are allowed because of singular covering/factor-space property. The model leads to the conclusion that dark matter is anyonic if the partonic 2-surface, which can have macroscopic or even astrophysical size, encloses the tip of  $CD$  within it. Therefore the partonic 2-surface is homologically non-trivial when the tip is regarded as a puncture. Fractional charges for anyonic elementary particles imply confinement to the partonic 2-surface and the particles can escape the two surface only via reactions transforming them to ordinary particles. This would

mean that the leakage between different pages of the big book is a rare phenomenon. This could partially explain why dark matter is so difficult to observe.

### Field body as carrier of dark matter

The notion of "field body" implied by topological field quantization is essential. There would be em,  $Z^0$ ,  $W$ , gluonic, and gravitonic field bodies, each characterized by its one prime. The motivation for considering the possibility of separate field bodies seriously is that the notion of induced gauge field means that all induced gauge fields are expressible in terms of four  $CP_2$  coordinates so that only single component of a gauge potential allows a representation as an independent field quantity. Perhaps also separate magnetic and electric field bodies for each interaction and identifiable as flux quanta must be considered. This kind of separation requires that the fermionic content of the flux quantum (say fermion and anti-fermion at the ends of color flux tube) is such that it conforms with the quantum numbers of the corresponding boson.

What is interesting that the conceptual separation of interactions to various types would have a direct correlate at the level of space-time topology. From a different perspective inspired by the general vision that many-sheeted space-time provides symbolic representations of quantum physics, the very fact that we make this conceptual separation of fundamental interactions could reflect the topological separation at space-time level.

p-Adic mass calculations for quarks encourage to think that the p-adic length scale characterizing the mass of particle is associated with its electromagnetic body and in the case of neutrinos with its  $Z^0$  body.  $Z^0$  body can contribute also to the mass of charged particles but the contribution would be small. It is also possible that these field bodies are purely magnetic for color and weak interactions. Color flux tubes would have exotic fermion and anti-fermion at their ends and define colored variants of pions. This would apply not only in the case of nuclear strings but also to molecules and larger structures so that scaled variants of elementary particles and standard model would appear in all length scales as indeed implied by the fact that classical electro-weak and color fields are unavoidable in TGD framework.

One can also go further and distinguish between magnetic field body of free particle for which flux quanta start and return to the particle and "relative field" bodies associated with pairs of particles. Very complex structures emerge and should be essential for the understanding the space-time correlates of various interactions. In a well-defined sense they would define space-time correlate for the conceptual analysis of the interactions into separate parts. In order to minimize confusion it should be emphasized that the notion of field body used in this chapter relates to those space-time correlates of interactions, which are more or less *static* and related to the formation of *bound states*.

### 14.5.2 Phase transitions changing Planck constant

The general picture is that p-adic length scale hierarchy corresponds to p-adic coupling constant evolution and hierarchy of Planck constants to the coupling constant evolution related to phase resolution. Both evolutions imply a book like structure of the generalized imbedding space.

#### Transition to large $\hbar$ phase and failure of perturbation theory

One of the first ideas was that the transition to large  $\hbar$  phase occurs when perturbation theory based on the expansion in terms of gauge coupling constant ceases to converge: Mother Nature would take care of the problems of theoretician. The transition to large  $\hbar$  phase obviously reduces the value of gauge coupling strength  $\alpha \propto 1/\hbar$  so that higher orders in perturbation theory are reduced whereas the lowest order "classical" predictions remain unchanged. A possible quantitative formulation of the criterion is that maximal 2-particle gauge interaction strength parameterized as  $Q_1 Q_2 \alpha$  satisfies the condition  $Q_1 Q_2 \alpha \simeq 1$ .

A justification for this picture would be that in non-perturbative phase large quantum fluctuations are present (as functional integral formalism suggests). At space-time level this could mean that space-time sheet is near to a non-deterministic vacuum extremal -at least if homologically trivial geodesic sphere defines the number theoretic braids. At certain critical value of coupling constant strength one expects that the transition amplitude for phase transition becomes very large. The resulting phase would be of course different from the original since typically charge fractionization would occur.

One should understand why the failure of the perturbation theory (expected to occur for  $\alpha Q_1 Q_2 > 1$ ) induces the reduction of Clifford algebra, scaling down of  $CP_2$  metric, and whether the  $G$ -symmetry is exact or only approximate. A partial understanding already exists. The discrete  $G$  symmetry and the reduction of the dimension of Clifford algebra would have interpretation in terms of a loss of degrees of freedom as a strongly bound state is formed. The multiple covering of  $M_{\pm}^4$  accompanying strong binding can be understood as an automatic consequence of  $G$ -invariance. A concrete realization for the binding could be charge fractionization which would not allow the particles bound on large light-like 3-surface to escape without transformation to ordinary particles.

Two examples perhaps provide more concrete view about this idea.

1. The proposed scenario can reproduce the huge value of the gravitational Planck constant. One should however develop a convincing argument why non-perturbative phase for the gravitating dark matter leads to a formation of  $G_a \times$  covering of  $CD \setminus M^2 \times CP_2 \setminus S_I^2$  with the huge value of  $\hbar_{eff} = n_a/n_b \simeq GM_1 M_2/v_0$ . The basic argument is that the dimensionless parameter  $\alpha_{gr} = GM_1 M_2/4\pi\hbar$  should be so small that perturbation theory works. This gives  $\hbar_{gr} \geq GM_1 M_2/4\pi$  so that order of magnitude is predicted correctly.
2. Color confinement represents the simplest example of a transition to a non-perturbative phase. In this case  $A_2$  and  $n = 3$  would be the natural option. The value of Planck constant would be 3 times higher than its value in perturbative QCD. Hadronic space-time sheets would be 3-fold coverings of  $M_{\pm}^4$  and baryonic quarks of different color would reside on 3 separate sheets of the covering. This would resolve the color statistics paradox suggested by the fact that induced spinor fields do not possess color as spin like quantum number and by the facts that for orbifolds different quarks cannot move in independent  $CP_2$  partial waves assignable to  $CP_2$  cm degrees of freedom as in perturbative phase.

### The mechanism of phase transition and selection rules

The mechanism of phase transition is at classical level similar to that for ordinary phase transitions. The partonic 2-surface decomposes to regions corresponding to difference values of  $\hbar$  at quantum criticality in such a manner that regions in which induced Kähler form is non-vanishing are contained within single page of imbedding space. It might be necessary to assume that only a region corresponding to single value of  $\hbar$  is possible for partonic 2-surfaces and  $\delta CD \times CP_2$  so that quantum criticality would be associated with the intermediate state described by the light-like 3-surface. One could also see the phase transition as a leakage of  $X^2$  from given page to another: this is like going through a closed door through a narrow slit between door and floor. By quantum criticality the points of number theoretic braid are already in the slit.

As in the case of ordinary phase transitions the allowed phase transitions must be consistent with the symmetries involved. This means that if the state is invariant under the maximal cyclic subgroups  $G_a$  and  $G_b$  then also the final state must satisfy this condition. This gives constraints to the orders of maximal cyclic subgroups  $Z_a$  and  $Z_b$  for initial and final state:  $n(Z_{a_i})$  resp.  $n(Z_{b_i})$  must divide  $n(Z_{a_f})$  resp.  $n(Z_{b_f})$  or vice versa in the case that factors of  $Z_i$  do not leave invariant the states. If this is the case similar condition must hold true for appropriate subgroups. In particular, powers of prime  $Z_{p^n}$ ,  $n = 1, 2, \dots$  define hierarchies of allowed phase transitions.

### 14.5.3 Coupling constant evolution and hierarchy of Planck constants

If the overall vision is correct, quantum TGD would be characterized by two kinds of couplings constant evolutions. p-Adic coupling constant evolution would correspond to length scale resolution and the evolution with respect to Planck constant to phase resolution. Both evolution would have number theoretic interpretation.

#### Evolution with respect to phase resolution

The coupling constant evolution in phase resolution in p-adic degrees of freedom corresponds to emergence of algebraic extensions allowing increasing variety of phases  $\exp(i2\pi/n)$  expressible p-adically. This evolution can be assigned to the emergence of increasingly complex quantum phases and the increase of Planck constant.

One expects that quantum phases  $q = \exp(i\pi/n)$  which are expressible using only iterated square root operation are number theoretically very special since they correspond to algebraic extensions of p-adic numbers obtained by an iterated square root operation, which should emerge first. Therefore systems involving these values of  $q$  should be especially abundant in Nature. That arbitrarily high square roots are involved as becomes clear by studying the case  $n = 2^k$ :  $\cos(\pi/2^k) = \sqrt{[1 + \cos(\pi/2^{k-1})]}/2$ .

These polygons are obtained by ruler and compass construction and Gauss showed that these polygons, which could be called Fermat polygons, have  $n_F = 2^k \prod_s F_{n_s}$  sides/vertices: all Fermat primes  $F_{n_s}$  in this expression must be different. The analog of the p-adic length scale hypothesis emerges since larger Fermat primes are near a power of 2. The known Fermat primes  $F_n = 2^{2^n} + 1$  correspond to  $n = 0, 1, 2, 3, 4$  with  $F_0 = 3$ ,  $F_1 = 5$ ,  $F_2 = 17$ ,  $F_3 = 257$ ,  $F_4 = 65537$ . It is not known whether there are higher Fermat primes.  $n = 3, 5, 15$ -multiples of p-adic length scales clearly distinguishable from them are also predicted and this prediction is testable in living matter. I have already earlier considered the possibility that Fermat polygons could be of special importance for cognition and for biological information processing [K47].

This condition could be interpreted as a kind of resonance condition guaranteeing that scaled up sizes for space-time sheets have sizes given by p-adic length scales. The numbers  $n_F$  could take the same role in the evolution of Planck constant assignable with the phase resolution as Mersenne primes have in the evolution assignable to the p-adic length scale resolution.

The Dynkin diagrams of exceptional Lie groups  $E_6$  and  $E_8$  are exceptional as subgroups of rotation group in the sense that they cannot be reduced to symmetry transformations of plane. They correspond to the symmetry group  $S_4 \times Z_2$  of tetrahedron and  $A_5 \times Z_2$  of dodecahedron or its dual polytope icosahedron ( $A_5$  is 60-element subgroup of  $S_5$  consisting of even permutations). Maximal cyclic subgroups are  $Z_4$  and  $Z_5$  and thus their orders correspond to Fermat polygons. Interestingly,  $n = 5$  corresponds to minimum value of  $n$  making possible topological quantum computation using braids and also to Golden Mean.

### Is there a correlation between the values of p-adic prime and Planck constant?

The obvious question is whether there is a correlation between p-adic length scale and the value of Planck constant. One-to-one correspondence is certainly excluded but loose correlation seems to exist.

1. In [K2] the information about the number theoretic anatomy of Kähler coupling strength is combined with input from p-adic mass calculations predicting  $\alpha_K$  to be the value of fine structure constant at the p-adic length scale associated with electron. One can also develop an explicit expression for gravitational constant assuming its renormalization group invariance on basis of dimensional considerations and this model leads to a model for the fraction of volume of the wormhole contact (piece of  $CP_2$  type extremal) from the volume of  $CP_2$  characterizing gauge boson and for similar volume fraction for the piece of the  $CP_2$  type vacuum extremal associated with fermion.
2. The requirement that gravitational constant is renormalization group invariant implies that the volume fraction depends logarithmically on p-adic length scale and Planck constant (characterizing quantum scale). The requirement that this fraction in the range  $(0, 1)$  poses a correlation between the rational characterizing Planck constant and p-adic length scale. In particular, for space-time sheets mediating gravitational interaction Planck constant must be larger than  $\hbar_0$  above length scale which is about .1 Angstrom. Also an upper bound for  $\hbar$  for given p-adic length scale results but is very large. This means that quantum gravitational effects should become important above atomic length scale [K2].

## 14.6 Some applications

Below some applications of the hierarchy of Planck constants as a model of dark matter are briefly discussed. The range of applications varying from elementary particle physics to cosmology and I hope that this will convince the reader that the idea has strong physical motivations.

### 14.6.1 A simple model of fractional quantum Hall effect

The generalization of the imbedding space suggests that it could be possible to understand fractional quantum Hall effect [D1] at the level of basic quantum TGD. This section represents the first rough model of QHE constructed for a couple of years ago is discussed. Needless to emphasize, the model represents only the basic idea and involves an ad hoc assumption about charge fractionization.

Recall that the formula for the quantized Hall conductance is given by

$$\begin{aligned}\sigma &= \nu \times \frac{e^2}{h} , \\ \nu &= \frac{n}{m} .\end{aligned}\tag{14.6.1}$$

Series of fractions in  $\nu = 1/3, 2/5, 3/7, 4/9, 5/11, 6/13, 7/15, \dots, 2/3, 3/5, 4/7, 5/9, 6/11, 7/13, \dots, 5/3, 8/5, 11/7, 14/9, \dots, 4/3, 7/5, 10/7, 13/9, \dots, 1/5, 2/9, 3/13, \dots, 2/7, 3/11, \dots, 1/7, \dots$  with odd denominator have been observed as are also  $\nu = 1/2$  and  $\nu = 5/2$  states with even denominator [D1].

The model of Laughlin [D21] cannot explain all aspects of FQHE. The best existing model proposed originally by Jain is based on composite fermions resulting as bound states of electron and even number of magnetic flux quanta [D17]. Electrons remain integer charged but due to the effective magnetic field electrons appear to have fractional charges. Composite fermion picture predicts all the observed fractions and also their relative intensities and the order in which they appear as the quality of sample improves.

The generalization of the notion of imbedding space suggests the possibility to interpret these states in terms of fractionized charge, spin, and electron number. There are  $2 \times 2 = 4$  combinations of covering and factor spaces of  $CP_2$  and three of them can lead to the increase of Planck constant. Besides this one can consider two options for the formula of Planck constant so that which the very meager theoretical background one can make only guesses. In the following a model based on option II for which the number of states is conserved in the phase transition changing  $\hbar$ .

1. The easiest manner to understand the observed fractions is by assuming that both  $CD$  and  $CP_2$  correspond to covering spaces so that both spin and electric charge and fermion number are fractionized. This means that  $e$  in electronic charge density is replaced with fractional charge. Quantized magnetic flux is proportional to  $e$  and the question is whether also here fractional charge appears. Assume that this does not occur.
2. With this assumption the expression for the Planck constant becomes for Option II as  $r = \hbar/\hbar_0 = n_a/n_b$  and charge and spin units are equal to  $1/n_b$  and  $1/n_a$  respectively. This gives  $\nu = nn_a/n_b$ . The values  $m = 2, 3, 5, 7, \dots$  are observed. Planck constant can have arbitrarily large values. There are general arguments stating that also spin is fractionized in FQHE.
3. Both  $\nu = 1/2$  and  $\nu = 5/2$  state has been observed [D1, D14]. The fractionized charge is  $e/4$  in the latter case [D14, ?]. Since  $n_i > 3$  holds true if coverings and factor spaces are correlated for Jones inclusions, this requires  $n_a = 4$  and  $n_b = 8$  for  $\nu = 1/2$  and  $n_b = 4$  and  $n_a = 10$  for  $\nu = 5/2$ . Correct fractionization of charge is predicted. For  $n_b = 2$  also  $Z_2$  would appear as the fundamental group of the covering space. Filling fraction  $1/2$  corresponds in the composite fermion model and also experimentally to the limit of zero magnetic field [D17].  $n_b = 2$  is inconsistent with the observed fractionization of electric charge for  $\nu = 5/2$  and with the vision inspired by Jones inclusions.
4. A possible problematic aspect of the TGD based model is the experimental absence of even values of  $n_b$  except  $n_b = 2$  (Laughlin's model predicts only odd values of  $n$ ). A possible explanation is that by some symmetry condition possibly related to fermionic statistics (as in Laughlin model)  $n_a/n_b$  must reduce to a rational with an odd denominator for  $n_b > 2$ . In other words, one has  $n_a \propto 2^r$ , where  $2^r$  the largest power of 2 divisor of  $n_b$ .
5. Large values of  $n_a$  emerge as  $B$  increases. This can be understood from flux quantization. One has  $e \int BdS = n\hbar(M^4) = nn_a\hbar_0$ . By using actual fractional charge  $e_F = e/n_b$  in the flux factor would give  $e_F \int BdS = n(n_a/n_b)\hbar_0 = n\hbar$ . The interpretation is that each of the  $n_a$  sheets contributes one unit to the flux for  $e$ . Note that the value of magnetic field in given sheet is not



affected so that the build-up of multiple covering seems to keep magnetic field strength below critical value.

6. The understanding of the thermal stability is not trivial. The original FQHE was observed in 80 mK temperature corresponding roughly to a thermal energy of  $T \sim 10^{-5}$  eV. For graphene the effect is observed at room temperature. Cyclotron energy for electron is (from  $f_e = 6 \times 10^5$  Hz at  $B = .2$  Gauss) of order thermal energy at room temperature in a magnetic field varying in the range 1-10 Tesla. This raises the question why the original FQHE requires so low temperature. The magnetic energy of a flux tube of length  $L$  is by flux quantization roughly  $e^2 B^2 S \sim E_c(e) m_e L$  ( $\hbar_0 = c = 1$ ) and exceeds cyclotron roughly by a factor  $L/L_e$ ,  $L_e$  electron Compton length so that thermal stability of magnetic flux quanta is not the explanation. A possible explanation is that since FQHE involves several values of Planck constant, it is quantum critical phenomenon and is characterized by a critical temperature. The differences of the energies associated with the phase with ordinary Planck constant and phases with different Planck constant would characterize the transition temperature.

As already noticed, it is possible to imagine several other options and the assumption about charge fractionization -although consistent with fractionization for  $\nu = 5/2$ , is rather adhoc. Therefore the model can be taken as a warm-up exercise only. In [?] , where the delicacies of Kähler structure of generalized imbedding space are discussed, also a more detailed of QHE is discussed.

### 14.6.2 Gravitational Bohr orbitology

The basic question concerns justification for gravitational Bohr orbitology [K65] . The basic vision is that visible matter identified as matter with  $\hbar = \hbar_0$  ( $n_a = n_b = 1$ ) concentrates around dark matter at Bohr orbits for dark matter particles. The question is what these Bohr orbits really mean. Should one in improved approximation relate Bohr orbits to 3-D wave functions for dark matter as ordinary Bohr rules would suggest or do the Bohr orbits have some deeper meaning different from that in wave mechanics. Anyonic variants of partonic 2-surfaces with astrophysical size are a natural guess for the generalization of Bohr orbits.

#### Dark matter as large $\hbar$ phase

D. Da Rocha and Laurent Nottale have proposed that Schrödinger equation with Planck constant  $\hbar$  replaced with what might be called gravitational Planck constant  $\hbar_{gr} = \frac{GmM}{v_0}$  ( $\hbar = c = 1$ ).  $v_0$  is a velocity parameter having the value  $v_0 = 144.7 \pm .7$  km/s giving  $v_0/c = 4.6 \times 10^{-4}$ . This is rather near to the peak orbital velocity of stars in galactic halos. Also subharmonics and harmonics of  $v_0$  seem to appear. The support for the hypothesis coming from empirical data is impressive [K65] .

Nottale and Da Rocha believe that their Schrödinger equation results from a fractal hydrodynamics. Many-sheeted space-time however suggests astrophysical systems are not only quantum systems at larger space-time sheets but correspond to a gigantic value of gravitational Planck constant. The gravitational (ordinary) Schrödinger equation -or at least Bohr rules with appropriate interpretation - would provide a solution of the black hole collapse (IR catastrophe) problem encountered at the classical level. The resolution of the problem inspired by TGD inspired theory of living matter is that it is the dark matter at larger space-time sheets which is quantum coherent in the required time scale.

#### Prediction for the parameter $v_0$

One of the key questions relate to the value of the parameter  $v_0$ . Before the introduction of the hierarchy of Planck constants I proposed that the value of the parameter  $v_0$  assuming that cosmic strings and their decay remnants are responsible for the dark matter. The harmonics of  $v_0$  can be understood as corresponding to perturbations replacing cosmic strings with their  $n$ -branched coverings so that tension becomes  $n$ -fold much like the replacement of a closed orbit with an orbit closing only after  $n$  turns.  $1/n$ -sub-harmonic would result when a magnetic flux tube split into  $n$  disjoint magnetic flux tubes. The planetary mass ratios can be produced with an accuracy better than 10 per cent assuming ruler and compass phases.

### Further predictions

The study of inclinations (tilt angles with respect to the Earth's orbital plane) leads to a concrete model for the quantum evolution of the planetary system. Only a stepwise breaking of the rotational symmetry and angular momentum Bohr rules plus Newton's equation (or geodesic equation) are needed, and gravitational Schrödinger equation holds true only inside flux quanta for the dark matter.

1. During pre-planetary period dark matter formed a quantum coherent state on the ( $Z^0$ ) magnetic flux quanta (spherical cells or flux tubes). This made the flux quantum effectively a single rigid body with rotational degrees of freedom corresponding to a sphere or circle (full  $SO(3)$  or  $SO(2)$  symmetry).
2. In the case of spherical shells associated with inner planets the  $SO(3) \rightarrow SO(2)$  symmetry breaking led to the generation of a flux tube with the inclination determined by  $m$  and  $j$  and a further symmetry breaking, kind of an astral traffic jam inside the flux tube, generated a planet moving inside flux tube. The semiclassical interpretation of the angular momentum algebra predicts the inclinations of the inner planets. The predicted (real) inclinations are 6 (7) resp. 2.6 (3.4) degrees for Mercury resp. Venus). The predicted (real) inclination of the Earth's spin axis is 24 (23.5) degrees.
3. The  $v_0 \rightarrow v_0/5$  transition allowing to understand the radii of the outer planets in the model of Da Rocha and Nottale can be understood as resulting from the splitting of ( $Z^0$ ) magnetic flux tube to five flux tubes representing Earth and outer planets except Pluto, whose orbital parameters indeed differ dramatically from those of other planets. The flux tube has a shape of a disk with a hole glued to the Earth's spherical flux shell.

It is important to notice that effectively a multiplication  $n \rightarrow 5n$  of the principal quantum number is in question. This allows to consider also alternative explanations. Perhaps external gravitational perturbations have kicked dark matter from the orbit or Earth to  $n = 5k$ ,  $k = 2, 3, \dots, 7$  orbits: the fact that the tilt angles for Earth and all outer planets except Pluto are nearly the same, supports this explanation. Or perhaps there exist at least small amounts of dark matter at all orbits but visible matter is concentrated only around orbits containing some critical amount of dark matter and these orbits satisfy  $n \bmod 5 = 0$  for some reason.

4. A remnant of the dark matter is still in a macroscopic quantum state at the flux quanta. It couples to photons as a quantum coherent state but the coupling is extremely small due to the gigantic value of  $\hbar_{gr}$  scaling alpha by  $\hbar/\hbar_{gr}$ : hence the darkness.

The rather amazing coincidences between basic bio-rhythms and the periods associated with the states of orbits in solar system suggest that the frequencies defined by the energy levels of the gravitational Schrödinger equation might entrain with various biological frequencies such as the cyclotron frequencies associated with the magnetic flux tubes. For instance, the period associated with  $n = 1$  orbit in the case of Sun is 24 hours within experimental accuracy for  $v_0$ .

### Comparison with Bohr quantization of planetary orbits

The predictions of the generalization of the p-adic length scale hypothesis are consistent with the TGD based model for the Bohr quantization of planetary orbits and some new non-trivial predictions follow.

1. The model can explain the enormous values of gravitational Planck constant  $\hbar_{gr}/\hbar_0 = \simeq GMm/v_0) = n_a/n_b$ . The favored values of this parameter should correspond to  $n_{F_a}/n_{F_b}$  so that the mass ratios  $m_1/m_2 = n_{F_{a,1}}n_{F_{b,2}}/n_{F_{b,1}}n_{F_{a,2}}$  for planetary masses should be preferred. The general prediction  $GMm/v_0 = n_a/n_b$  is of course not testable.
2. Nottale [E23] has suggested that also the harmonics and sub-harmonics of  $\hbar_{gr}$  are possible and in fact required by the model for planetary Bohr orbits (in TGD framework this is not absolutely necessary [K65]). The prediction is that favored values of  $n$  should be of form  $n_F = 2^k \prod F_i$  such that  $F_i$  appears at most once. In Nottale's model for planetary orbits as Bohr orbits in solar system [K65]  $n = 5$  harmonics appear and are consistent with either  $n_{F,a} \rightarrow F_1 n_{F_a}$  or with  $n_{F,b} \rightarrow n_{F_b}/F_1$  if possible.

The prediction for the ratios of planetary masses can be tested. In the table below are the experimental mass ratios  $r_{exp} = m(pl)/m(E)$ , the best choice of  $r_R = [n_{F,a}/n_{F,b}] * X$ ,  $X$  common factor for all planets, and the ratios  $r_{pred}/r_{exp} = n_{F,a}(planet)n_{F,b}(Earth)/n_{F,a}(Earth)n_{F,b}(planet)$ . The deviations are at most 2 per cent.

<i>planet</i>	<i>Me</i>	<i>V</i>	<i>E</i>	<i>M</i>	<i>J</i>
<i>y</i>	$\frac{2^{13} \times 5}{17}$	$2^{11} \times 17$	$2^9 \times 5 \times 17$	$2^8 \times 17$	$\frac{2^{23} \times 5}{7}$
<i>y/x</i>	1.01	.98	1.00	.98	1.01
<i>planet</i>	<i>S</i>	<i>U</i>	<i>N</i>	<i>P</i>	
<i>y</i>	$2^{14} \times 3 \times 5 \times 17$	$\frac{2^{21} \times 5}{17}$	$\frac{2^{17} \times 17}{3}$	$\frac{2^4 \times 17}{3}$	
<i>y/x</i>	1.01	.98	.99	.99	

Table 1. The table compares the ratios  $x = m(pl)/(m(E))$  of planetary mass to the mass of Earth to prediction for these ratios in terms of integers  $n_F$  associated with Fermat polygons.  $y$  gives the best fit for the allowed factors of the known part  $y$  of the rational  $n_{F,a}/n_{F,b} = yX$  characterizing planet, and the ratios  $y/x$ . Errors are at most 2 per cent.

A stronger prediction comes from the requirement that  $GMm/v_0$  equals to  $n = n_{F,a}/n_{F,b}$   $n_F = 2^k \prod_k F_{n_k}$ , where  $F_i = 2^{2^i} + 1$ ,  $i = 0, 1, 2, 3, 4$  is Fibonacci prime. The fit using solar mass and Earth mass gives  $n_F = 2^{254} \times 5 \times 17$  for  $1/v_0 = 2044$ , which within the experimental accuracy equals to the value  $2^{11} = 2048$  whose powers appear as scaling factors of Planck constant in the model for living matter [K22]. For  $v_0 = 4.6 \times 10^{-4}$  reported by Nottale the prediction is by a factor 16/17.01 too small (6 per cent discrepancy).

A possible solution of the discrepancy is that the empirical estimate for the factor  $GMm/v_0$  is too large since  $m$  contains also the the visible mass not actually contributing to the gravitational force between dark matter objects whereas  $M$  is known correctly. The assumption that the dark mass is a fraction  $1/(1 + \epsilon)$  of the total mass for Earth gives

$$1 + \epsilon = \frac{17}{16} \tag{14.6.2}$$

in an excellent approximation. This gives for the fraction of the visible matter the estimate  $\epsilon = 1/16 \simeq 6$  per cent. The estimate for the fraction of visible matter in cosmos is about 4 per cent so that estimate is reasonable and would mean that most of planetary and solar mass would be also dark (as a matter dark energy would be in question).

That  $v_0(eff) = v_0/(1 - \epsilon) \simeq 4.6 \times 10^{-4}$  equals with  $v_0(eff) = 1/(2^7 \times F_2) = 4.5956 \times 10^{-4}$  within the experimental accuracy suggests a number theoretical explanation for the visible-to-dark fraction.

The original unconsciously performed identification of the gravitational and inertial Planck constants leads to some confusing conclusions but it seems that the new view about the quantization of Planck constants resolves these problems and allows to see  $\hbar_{gr}$  as a special case of  $\hbar_I$ .

1.  $\hbar_{gr}$  is proportional to the product of masses of interacting systems and not a universal constant like  $\hbar$ . One can however express the gravitational Bohr conditions as a quantization of circulation  $\oint v \cdot dl = n(GM/v_0)\hbar_0$  so that the dependence on the planet mass disappears as required by Equivalence Principle. This would suggest that gravitational Bohr rules relate to velocity rather than inertial momentum as is indeed natural. The quantization of circulation is consistent with the basic prediction that space-time surfaces are analogous to Bohr orbits.
2.  $\hbar_{gr}$  seems to characterize a relationship between planet and central mass and quite generally between two systems with the property that smaller system is topologically condensed at the space-time sheet of the larger system. Thus it would seem that  $\hbar_{gr}$  is not a universal constant and cannot correspond to a special value of ordinary Planck constant. Certainly this would be the case if  $\hbar_I$  is quantized as  $\lambda^k$ -multiplet of ordinary Planck constant with  $\lambda \simeq 2^{11}$ .

The recent view about the quantization of Planck constant in terms of coverings of  $CD$  seems to resolve these problems.

1. The integer quantization of Planck constants is consistent with the huge values of gravitational Planck constant within experimental resolution and the killer test for  $\hbar = \hbar_{gr}$  emerges if one takes seriously the stronger prediction  $\hbar_{gr} = n_{F,a}/n_{F,b}$ .
2. One can also regard  $\hbar_{gr}$  as ordinary Planck constant  $\hbar_{eff}$  associated with the space-time sheet along which the masses interact provided each pair  $(M, m_i)$  of masses is characterized by its own sheets. These sheets could correspond to flux tube like structures carrying the gravitational flux of dark matter. If these sheets corresponds to  $n_{F_a}$ -fold covering of  $CD$ , one can understand  $\hbar_{gr}$  as a particular instance of the  $\hbar_{eff}$ .

### Quantum Hall effect and dark anyonic systems in astrophysical scales

Bohr orbitology could be understood if dark matter concentrates on 2-dimensional partonic surfaces usually assigned with elementary particles and having size of order  $CP_2$  radius. The interpretation is in terms of wormhole throats assignable to topologically condensed  $CP_2$  type extremals (fermions) and pairs of them assignable to wormhole contacts (gauge bosons). Wormhole throat defines the light-like 3-surface at which the signature of metric of space-time surface changes from Minkowskian to Euclidian.

Large value of Planck constant would allow partons with astrophysical size. Since anyonic systems are 2-dimensional, the natural idea is that dark matter corresponds to systems carrying large fermion number residing at partonic 2-surfaces of astrophysical size and that visible matter condenses around these. Not only black holes but also ordinary stars, planetary systems, and planets could correspond at the level of dark matter to atom like structures consisting of anyonic 2-surfaces which can have complex topology (flux tubes associated with planetary orbits connected by radial flux tubes to the central spherical anyonic surface). Charge and spin fractionization are key features of anyonic systems and Jones inclusions inspiring the generalization of imbedding space indeed involve quantum groups central in the modeling of anyonic systems. Hence one has could hopes that a coherent theoretical picture could emerge along these lines.

This seems to be the case. Anyons and charge and spin fractionization are discussed in detail [?] and leads to a precise identification of the delicacies involved with the Kähler gauge potential of  $CP_2$  Kähler form in the sectors of the generalized imbedding space corresponding to various pages of boook like structures assignable to  $CD$  and  $CP_2$ . The basic outcome is that anyons correspond geometrically to partonic 2-surfaces at the light-like boundaries of  $CD$  containing the tip of  $CD$  inside them. This is what gives rise to charge fractionization and also to confinement like effects since elementary particles in anyonic states cannot as such leak to the other pages of the generalized imbedding space.  $G_a$  and  $G_b$  invariance of the states imply that fractionization occurs only at single particle level and total charge is integer valued.

This picture is much more flexible that that based on  $G_a$  symmetries of  $CD$  orbifold since partonic 2-surfaces do not possess any orbifold symmetries in  $CD$  sector anymore. In this framework various astrophysical structures such as spokes and circles would be parts of anyonic 2-surfaces with complex topology representing quantum geometrically quantum coherence in the scale of say solar system. Planets would have formed by the condensation of ordinary matter in the vicinity of the anyonic matter. This would predict stars, planetary system, and even planets to have onion-like structure consisting of shells at the level of dark matter. Similar conclusion is suggested also by purely classical model for the final state of star predicting that matter is strongly concentrated at the surface of the star [K77].

### Anyonic view about blackholes

A new element to the model of black hole comes from the vision that black hole horizon as a light-like 3-surface corresponds to a light-like orbit of light-like partonic 2-surface. This allows two kinds of black holes. Fermion like black hole would correspond to a deformed  $CP_2$  type extremal which Euclidian signature of metric and topologically condensed at a space-time sheet with a Minkowskian signature. Boson like black hole would correspond to a wormhole contact connecting two space-time sheets with Minkowskian signature. Wormhole contact would be a piece deformed  $CP_2$  type extremal possessing two light-like throats defining two black hole horizons very near to each other. It does not seem absolutely necessary to assume that the interior metric of the black-hole is realized in another space-time sheet with Minkowskian signature.

Second new element relates to the value of Planck constant. For  $\hbar_{gr} = 4GM^2$  the Planck length  $L_P(\hbar) = \sqrt{\hbar G}$  equals to Schwarzschild radius and Planck mass equals to  $M_P(\hbar) = \sqrt{\hbar/G} = 2M$ . If the mass of the system is below the ordinary Planck mass:  $M \leq m_P(\hbar_0)/2 = \sqrt{\hbar_0/4G}$ , gravitational Planck constant is smaller than the ordinary Planck constant.

Black hole surface contains ultra dense matter so that perturbation theory is not expected to converge for the standard value of Planck constant but do so for gravitational Planck constant. If the phase transition increasing Planck constant is a friendly gesture of Nature making perturbation theory convergent, one expects that only the black holes for which Planck constant is such that  $GM^2/4\pi\hbar < 1$  holds true are formed. Black hole entropy -being proportional to  $1/\hbar$ - is of order unity so that TGD black holes are not very entropic.

If the partonic 2-surface surrounds the tip of causal diamond  $CD$ , the matter at its surface is in anyonic state with fractional charges. Anyonic black hole can be seen as single gigantic elementary particle stabilized by fractional quantum numbers of the constituents preventing them from escaping from the system and transforming to ordinary visible matter. A huge number of different black holes are possible for given value of  $\hbar$  since there is infinite variety of pairs  $(n_a, n_b)$  of integers giving rise to same value of  $\hbar$ .

One can imagine that the partonic surface is not exact sphere except for ideal black holes but contains large number of magnetic flux tubes giving rise to handles. Also a pair of spheres with different radii can be considered with surfaces of spheres connected by braided flux tubes. The braiding of these handles can represent information and one can even consider the possibility that black hole can act as a topological quantum computer. There would be no sharp difference between the dark parts of black holes and those of ordinary stars. Only the volume containing the complex flux tube structures associated with the orbits of planets and various objects around star would become very small for black hole so that the black hole might code for the topological information of the matter collapsed into it.

### 14.6.3 Accelerating periods of cosmic expansion as phase transitions increasing the value of Planck constant

There are several pieces of evidence for accelerated expansion, which need not mean cosmological constant, although this is the interpretation adopted in [?, ?]. Quantum cosmology predicts that astrophysical objects do not follow cosmic expansion except in jerk-wise quantum leaps increasing the value of the gravitational Planck constant. This assumption provides explanation for the apparent cosmological constant. Also planets are predicted to expand in this manner. This provides a new version of Expanding Earth theory originally postulated to explain the intriguing findings suggesting that continents have once formed a connected continent covering the entire surface of Earth but with radius which was one half of the recent one.

#### The four pieces of evidence for accelerated expansion

##### 1. *Supernovas of type Ia*

Supernovas of type *Ia* define standard candles since their luminosity varies in an oscillatory manner and the period is proportional to the luminosity. The period gives luminosity and from this the distance can be deduced by using Hubble's law:  $d = cz/H_0$ ,  $H_0$  Hubble's constant. The observation was that the farther the supernova was the more dimmer it was as it should have been. In other words, Hubble's constant increased with distance and the cosmic expansion was accelerating rather than decelerating as predicted by the standard matter dominated and radiation dominated cosmologies.

##### 2. *Mass density is critical and 3-space is flat*

It is known that the contribution of ordinary and dark matter explaining the constant velocity of distance stars rotating around galaxy is about 25 per cent from the critical density. Could it be that total mass density is critical?

From the anisotropy of cosmic microwave background one can deduce that this is the case. What criticality means geometrically is that 3-space defined as surface with constant value of cosmic time is flat. This reflects in the spectrum of microwave radiation. The spots representing small anisotropies

in the microwave background temperature is 1 degree and this correspond to flat 3-space. If one had dark matter instead of dark energy the size of spot would be .5 degrees!

Thus in a cosmology based on general relativity cosmological constant remains the only viable option. The situation is different in TGD based quantum cosmology based on sub-manifold gravity and hierarchy of gravitational Planck constants.

### 3. *The energy density of vacuum is constant in the size scale of big voids*

It was observed that the density of dark energy would be constant in the scale of  $10^8$  light years. This length scale corresponds to the size of big voids containing galaxies at their boundaries.

### 4. *Integrated Sachs-Wolf effect*

Also so called integrated Sachs-Wolf effect supports accelerated expansion. Very slow variations of mass density are considered. These correspond to gravitational potentials. Cosmic expansion tends to flatten them but mass accretion to form structures compensates this effect so that gravitational potentials are unaffected and there is no effect of CMB. Situation changes if dark matter is replaced with dark energy the accelerated expansion flattening the gravitational potentials wins the tendency of mass accretion to make them deeper. Hence if photon passes by an over-dense region, it receives a little energy. Similarly, photon loses energy when passing by an under-dense region. This effect has been observed.

## Accelerated expansion in classical TGD

The minimum TGD based explanation for accelerated expansion involves only the fact that the imbeddings of critical cosmologies correspond to accelerated expansion. A more detailed model allows to understand why the critical cosmology appears during some periods.

The first observation is that critical cosmologies (flat 3-space) imbeddable to 8-D imbedding space  $H$  correspond to negative pressure cosmologies and thus to accelerating expansion. The negativity of the counterpart of pressure in Einstein tensor is due to the fact that space-time sheet is forced to be a 4-D surface in 8-D imbedding space. This condition is analogous to a force forcing a particle at the surface of 2-sphere and gives rise to what could be called constraint force. Gravitation in TGD is sub-manifold gravitation whereas in GRT it is manifold gravitation. This would be minimum interpretation involving no assumptions about what mechanism gives rise to the critical periods.

## Accelerated expansion and hierarchy of Planck constants

One can go one step further and introduce the hierarchy of Planck constants. The basic difference between TGD and GRT based cosmologies is that TGD cosmology is quantum cosmology. Smooth cosmic expansion is replaced by an expansion occurring in discrete jerks corresponding to the increase of gravitational Planck constant. At space-time level this means the replacement of 8-D imbedding space  $H$  with a book like structure containing almost-copies of  $H$  with various values of Planck constant as pages glued together along critical manifold through which space-time sheet can leak between sectors with different values of  $\hbar$ . This process is the geometric correlate for the the phase transition changing the value of Planck constant.

During these phase transition periods critical cosmology applies and predicts automatically accelerated expansion. Neither genuine negative pressure due to "quintessence" nor cosmological constant is needed. Note that quantum criticality replaces inflationary cosmology and predicts a unique cosmology apart from single parameter. Criticality also explains the fluctuations in microwave temperature as long range fluctuations characterizing criticality.

## Accelerated expansion and flatness of 3-cosmology

Observations 1) and 2) about super-novae and critical cosmology (flat 3-space) are consistent with this cosmology. In TGD dark energy must be replaced with dark matter because the mass density is critical during the phase transition. This does not lead to wrong sized spots since it is the increase of Planck constant which induces the accelerated expansion understandable also as a constraint force due to imbedding to  $H$ .

### The size of large voids is the characteristic scale

The TGD based model in its simplest form model assigns the critical periods of expansion to large voids of size  $10^8$  ly. Also larger and smaller regions can express similar periods and dark space-time sheets are expected to obey same universal "cosmology" apart from a parameter characterizing the duration of the phase transition. Observation 3) that just this length scale defines the scale below which dark energy density is constant is consistent with TGD based model.

The basic prediction is jerkwise cosmic expansion with jerks analogous to quantum transitions between states of atom increasing the size of atom. The discovery of large voids with size of order  $10^8$  ly but age much longer than the age of galactic large voids conforms with this prediction. On the other hand, it is known that the size of galactic clusters has not remained constant in very long time scale so that jerkwise expansion indeed seems to occur.

### Do cosmic strings with negative gravitational mass cause the phase transition inducing accelerated expansion

Quantum classical correspondence is the basic principle of quantum TGD and suggest that the effective antigravity manifested by accelerated expansion might have some kind of concrete space-time correlate. A possible correlate is super heavy cosmic string like objects at the center of large voids which have negative gravitational mass under very general assumptions. The repulsive gravitational force created by these objects would drive galaxies to the boundaries of large voids. At some state the pressure of galaxies would become too strong and induce a quantum phase transition forcing the increase of gravitational Planck constant and expansion of the void taking place much faster than the outward drift of the galaxies. This process would repeat itself. In the average sense the cosmic expansion would not be accelerating.

#### 14.6.4 Phase transition changing Planck constant and expanding Earth theory

TGD predicts that cosmic expansion at the level of individual astrophysical systems does not take place continuously as in classical gravitation but through discrete quantum phase transitions increasing gravitational Planck constant and thus various quantum length and time scales. The reason would be that stationary quantum states for dark matter in astrophysical length scales cannot expand. One would have the analog of atomic physics in cosmic scales. Increases of  $\hbar$  by a power of two are favored in these transitions but also other scalings are possible.

This has quite far reaching implications.

1. These periods have a highly unique description in terms of a critical cosmology for the expanding space-time sheet. The expansion is accelerating. The accelerating cosmic expansion can be assigned to this kind of phase transition in some length scale (TGD Universe is fractal). There is no need to introduce cosmological constant and dark energy would be actually dark matter.
2. The recently observed void which has same size of about  $10^8$  light years as large voids having galaxies near their boundaries but having an age which is much higher than that of the large voids, would represent one example of jerk-wise expansion.
3. This picture applies also to solar system and planets might be perhaps seen as having once been parts of a more or less connected system, the primordial Sun. The Bohr orbits for inner and outer planets correspond to gravitational Planck constant which is 5 times larger for outer planets. This suggests that the space-time sheet of outer planets has suffered a phase transition increasing the size scale by a factor of 5. Earth can be regarded either as  $n=1$  orbit for Planck constant associated with outer planets or  $n=5$  orbit for inner planetary system. This might have something to do with the very special position of Earth in planetary system. One could even consider the possibility that both orbits are present as dark matter structures. The phase transition would also explain why  $n=1$  and  $n=2$  Bohr orbits are absent and one only  $n=3,4$ , and 5 are present.
4. Also planets should have experienced this kind of phase transitions increasing the radius: the increase by a factor two would be the simplest situation.

The obvious question - that I did not ask - is whether this kind of phase transition might have occurred for Earth and led from a completely granite covered Earth - Pangeia without seas - to the recent Earth. Neither it did not occur to me to check whether there is any support for a rapid expansion of Earth during some period of its history.

Situation changed when my son visited me last Saturday and told me about a Youtube video [?] by Neal Adams, an American comic book and commercial artist who has also produced animations for geologists. We looked the amazing video a couple of times and I looked it again yesterday. The video is very impressive artwork but in the lack of references skeptic probably cannot avoid the feeling that Neal Adams might use his highly developed animation skills to cheat you. I found also a polemic article [?] of Adams but again the references were lacking. Perhaps the reason of polemic tone was that the concrete animation models make the expanding Earth hypothesis very convincing but geologists refuse to consider seriously arguments by a layman without a formal academic background.

### The claims of Adams

The basic claims of Adams were following.

1. The radius of Earth has increased during last 185 million years (dinosaurs [?] appeared for about 230 million years ago) by about factor 2. If this is assumed all continents have formed at that time a single super-continent, Pangeia, filling the entire Earth surface rather than only 1/4 of it since the total area would have grown by a factor of 4. The basic argument was that it is very difficult to imagine Earth with 1/4 of surface containing granite and 3/4 covered by basalt. If the initial situation was covering by mere granite -as would look natural- it is very difficult for a believer in thermodynamics to imagine how the granite would have gathered to a single connected continent.
2. Adams claims that Earth has grown by keeping its density constant, rather than expanded, so that the mass of Earth has grown linearly with radius. Gravitational acceleration would have thus doubled and could provide a partial explanation for the disappearance of dinosaurs: it is difficult to cope in evolving environment when you get slower all the time.
3. Most of the sea floor is very young and the areas covered by the youngest basalt are the largest ones. This Adams interprets this by saying that the expansion of Earth is accelerating. The alternative interpretation is that the flow rate of the magma slows down as it recedes from the ridge where it erupts. The upper bound of 185 million years for the age of sea floor requires that the expansion period - if it is already over - lasted about 185 million years after which the flow increasing the area of the sea floor transformed to a convective flow with subduction so that the area is not increasing anymore.
4. The fact that the continents fit together - not only at the Atlantic side - but also at the Pacific side gives strong support for the idea that the entire planet was once covered by the super-continent. After the emergence of subduction theory this evidence as been dismissed.
5. I am not sure whether Adams mentions the following objections [?] . Subduction only occurs on the other side of the subduction zone so that the other side should show evidence of being much older in the case that oceanic subduction zones are in question. This is definitely not the case. This is explained in plate tectonics as a change of the subduction direction. My explanation would be that by the symmetry of the situation both oceanic plates bend down so that this would represent new type of boundary not assumed in the tectonic plate theory.
6. As a master visualizer Adams notices that Africa and South-America do not actually fit together in absence of expansion unless one assumes that these continents have suffered a deformation. Continents are not easily deformable stuff. The assumption of expansion implies a perfect fit of *all* continents without deformation.

Knowing that the devil is in the details, I must admit that these arguments look rather convincing to me and what I learned from Wikipedia articles supports this picture.



### The critic of Adams of the subduction mechanism

The prevailing tectonic plate theory [?] has been compared to the Copernican revolution in geology. The theory explains the young age of the seafloor in terms of the decomposition of the lithosphere to tectonic plates and the convective flow of magma to which oceanic tectonic plates participate. The magma emerges from the crests of the mid ocean ridges representing a boundary of two plates and leads to the expansion of sea floor. The variations of the polarity of Earth's magnetic field coded in sea floor provide a strong support for the hypothesis that magma emerges from the crests.

The flow back to would take place at so called oceanic trenches [?] near continents which represent the deepest parts of ocean. This process is known as subduction. In subduction oceanic tectonic plate bends and penetrates below the continental tectonic plate, the material in the oceanic plate gets denser and sinks into the magma. In this manner the oceanic tectonic plate suffers a metamorphosis returning back to the magma: everything which comes from Earth's interior returns back. Subduction mechanism explains elegantly formation of mountains [?] (orogeny), earth quake zones, and associated zones of volcanic activity [?] .

Adams is very polemic about the notion of subduction, in particular about the assumption that it generates steady convective cycle. The basic objections of Adams against subduction are following.

1. There are not enough subduction zones to allow a steady situation. According to Adams, the situation resembles that for a flow in a tube which becomes narrower. In a steady situation the flow should accelerate as it approaches subduction zones rather than slow down. Subduction zones should be surrounded by large areas of sea floor with constant age. Just the opposite is suggested by the fact that the youngest portion of sea-floor near the ridges is largest. The presence of zones at which both ocean plates bend down could improve the situation. Also jamming of the flow could occur so that the thickness of oceanic plate increases with the distance from the eruption ridge. Jamming could increase also the density of the oceanic plate and thus the effectiveness of subduction.
2. There is no clear evidence that subduction has occurred at other planets. The usual defense is that the presence of sea is essential for the subduction mechanism.
3. One can also wonder what is the mechanism that led to the formation of single super continent Pangeia covering 1/4 of Earth's surface. How probable the gathering of all separate continents to form single cluster is? The later events would suggest that just the opposite should have occurred from the beginning.

### Expanding Earth theories are not new

After I had decided to check the claims of Adams, the first thing that I learned is that Expanding Earth theory [?] , whose existence Adams actually mentions, is by no means new. There are actually many of them.

The general reason why these theories were rejected by the main stream community was the absence of a convincing physical mechanism of expansion or of growth in which the density of Earth remains constant.

1. 1888 Yarkovski postulated some sort of aether absorbed by Earth and transforming to chemical elements (TGD version of aether could be dark matter). 1909 Mantovani postulated thermal expansion but no growth of the Earth's mass.
2. Paul Dirac's idea about changing Planck constant led Pascual Jordan in 1964 to a modification of general relativity predicting slow expansion of planets. The recent measurement of the gravitational constant imply that the upper bound for the relative change of gravitational constant is 10 time too small to produce large enough rate of expansion. Also many other theories have been proposed but they are in general conflict with modern physics.
3. The most modern version of Expanding Earth theory is by Australian geologist Samuel W. Carey. He calculated that in Cambrian period (about 500 million years ago) all continents were stuck together and covered the entire Earth. Deep seas began to evolve then.

### Summary of TGD based theory of Expanding Earth

TGD based model differs from the tectonic plate model but allows subduction which cannot imply considerable back-flow of magma. Let us sum up the basic assumptions and implications.

1. The expansion is or was due to a quantum phase transition increasing the value of gravitational Planck constant and forced by the cosmic expansion in the average sense.
2. Tectonic plates do not participate to the expansion and therefore new plate must be formed and the flow of magma from the crests of mid ocean ridges is needed. The decomposition of a single plate covering the entire planet to plates to create the mid ocean ridges is necessary for the generation of new tectonic plate. The decomposition into tectonic plates is thus prediction rather than assumption.
3. The expansion forced the decomposition of Pangeia super-continent covering entire Earth for about 530 million years ago to split into tectonic plates which began to recede as new non-expanding tectonic plate was generated at the ridges creating expanding sea floor. The initiation of the phase transition generated formation of deep seas.
4. The eruption of plasma from the crests of ocean ridges generated oceanic tectonic plates which did not participate to the expansion by density reduction but by growing in size. This led to a reduction of density in the interior of the Earth roughly by a factor  $1/8$ . From the upper bound for the age of the seafloor one can conclude that the period lasted for about 185 million years after which it transformed to convective flow in which the material returned back to the Earth interior. Subduction at continent-ocean floor boundaries and downwards double bending of tectonic plates at the boundaries between two ocean floors were the mechanisms. Thus tectonic plate theory would be more or less the correct description for the recent situation.
5. One can consider the possibility that the subducted tectonic plate does not transform to magma but is fused to the tectonic layer below continent so that it grows to an iceberg like structure. This need not lead to a loss of the successful predictions of plate tectonics explaining the generation of mountains, earthquake zones, zones of volcanic activity, etc...
6. From the video of Adams it becomes clear that the tectonic flow is East-West asymmetric in the sense that the western side is more irregular at large distances from the ocean ridge at the western side. If the magma rotates with slightly lower velocity than the surface of Earth (like liquid in a rotating vessel), the erupting magma would rotate slightly slower than the tectonic plate and asymmetry would be generated.
7. If the planet has not experienced a phase transition increasing the value of Planck constant, there is no need for the decomposition to tectonic plates and one can understand why there is no clear evidence for tectonic plates and subduction in other planets. The conductive flow of magma could occur below this plate and remain invisible.

The biological implications might provide a possibility to test the hypothesis.

1. Great steps of progress in biological evolution are associated with catastrophic geological events generating new evolutionary pressures forcing new solutions to cope in the new situation. Cambrian explosion indeed occurred about 530 years ago (the book "Wonderful Life" of Stephen Gould [126] explains this revolution in detail) and led to the emergence of multicellular creatures, and generated huge number of new life forms living in seas. Later most of them suffered extinction: large number of phylae and groups emerged which are not present nowadays.

Thus Cambrian explosion is completely exceptional as compared to all other dramatic events in the evolution in the sense that it created something totally new rather than only making more complex something which already existed. Gould also emphasizes the failure to identify any great change in the environment as a fundamental puzzle of Cambrian explosion. Cambrian explosion is also regarded in many quantum theories of consciousness (including TGD) as a revolution in the evolution of consciousness: for instance, micro-tubuli emerged at this time. The periods of expansion might be necessary for the emergence of multicellular life forms on planets and the fact that they unavoidably occur sooner or later suggests that also life develops unavoidably.

2. TGD predicts a decrease of the surface gravity by a factor  $1/4$  during this period. The reduction of the surface gravity would have naturally led to the emergence of dinosaurs 230 million years ago as a response coming 45 million years after the accelerated expansion ceased. Other reasons led then to the decline and eventual catastrophic disappearance of the dinosaurs. The reduction of gravity might have had some gradually increasing effects on the shape of organisms also at microscopic level and manifest itself in the evolution of genome during expansion period.
3. A possibly testable prediction following from angular momentum conservation ( $\omega R^2 = \text{constant}$ ) is that the duration of day has increased gradually and was four times shorter during the Cambrian era. For instance, genetically coded bio-clocks of simple organisms during the expansion period could have followed the increase of the length of day with certain lag or failed to follow it completely. The simplest known circadian clock is that of the prokaryotic cyanobacteria. Recent research has demonstrated that the circadian clock of *Synechococcus elongatus* can be reconstituted in vitro with just the three proteins of their central oscillator. This clock has been shown to sustain a 22 hour rhythm over several days upon the addition of ATP: the rhythm is indeed faster than the circadian rhythm. For humans the average innate circadian rhythm is however 24 hours 11 minutes and thus conforms with the fact that human genome has evolved much later than the expansion ceased.
4. Scientists have found a fossil of a sea scorpion with size of 2.5 meters [?] , which has lived for about 10 million years for 400 million years ago in Germany. The gigantic size would conform nicely with the much smaller value of surface gravity at that time. The finding would conform nicely with the much smaller value of surface gravity at that time. Also the emergence of trees could be understood in terms of a gradual growth of the maximum plant size as the surface gravity was reduced. The fact that the oldest known tree fossil is 385 million years old [?] conforms with this picture.

#### Did intra-terrestrial life burst to the surface of Earth during Cambrian expansion?

The possibility of intra-terrestrial life [K26] is one of the craziest TGD inspired ideas about the evolution of life and it is quite possible that in its strongest form the hypothesis is unrealistic. One can however try to find what one obtains from the combination of the IT hypothesis with the idea of pre-Cambrian granite Earth. Could the harsh pre-Cambrian conditions have allowed only intra-terrestrial multicellular life? Could the Cambrian explosion correspond to the moment of birth for this life in the very concrete sense that the magma flow brought it into the day-light?

1. Gould emphasizes the mysterious fact that very many life forms of Cambrian explosion looked like final products of a long evolutionary process. Could the eruption of magma from the Earth interior have induced a burst of intra-terrestrial life forms to the Earth's surface? This might make sense: the life forms living at the bottom of sea do not need direct solar light so that they could have had intra-terrestrial origin. It is quite possible that Earth's mantle contained low temperature water pockets, where the complex life forms might have evolved in an environment shielded from meteoric bombardment and UV radiation.
2. Sea water is salty. It is often claimed that the average salt concentration inside cell is that of the primordial sea: I do not know whether this claim can be really justified. If the claim is true, the cellular salt concentration should reflect the salt concentration of the water inside the pockets. The water inside water pockets could have been salty due to the diffusion of the salt from ground but need not have been same as that for the ocean water (higher than for cell interior and for obvious reasons). Indeed, the water in the underground reservoirs in arid regions such as Sahara is salty, which is the reason for why agriculture is absent in these regions. Note also that the cells of marine invertebrates are osmoconformers able to cope with the changing salinity of the environment so that the Cambrian revolutionaries could have survived the change in the salt concentration of environment.
3. What applies to Earth should apply also to other similar planets and Mars [?] is very similar to Earth. The radius is .533 times that for Earth so that after quantum leap doubling the radius and thus Schumann frequency scale (7.8 Hz would be the lowest Schumann frequency) would be essentially same as for Earth now. Mass is .131 times that for Earth so that surface gravity

would be .532 of that for Earth now and would be reduced to .131 meaning quite big dinosaurs! have learned that Mars probably contains large water reservoirs in it's interior and that there is an un-identified source of methane gas usually assigned with the presence of life. Could it be that Mother Mars is pregnant and just waiting for the great quantum leap when it starts to expand and gives rise to a birth of multicellular life forms. Or expressing freely how Bible describes the moment of birth: in the beginning there was only darkness and water and then God said Let the light come!

To sum up, TGD would provide only the long sought mechanism of expansion and a possible connection with the biological evolution. It would be indeed fascinating if Planck constant changing quantum phase transitions in planetary scale would have profoundly affected the biosphere.

### 14.6.5 Allais effect as evidence for large values of gravitational Planck constant?

Allais effect [E2, E11] is a fascinating gravitational anomaly associated with solar eclipses. It was discovered originally by M. Allais, a Nobelist in the field of economy, and has been reproduced in several experiments but not as a rule. The experimental arrangement uses so called paraconical pendulum, which differs from the Foucault pendulum in that the oscillation plane of the pendulum can rotate in certain limits so that the motion occurs effectively at the surface of sphere.

#### Experimental findings

Consider first a brief summary of the findings of Allais and others [E11] .

a) In the ideal situation (that is in the absence of any other forces than gravitation of Earth) paraconical pendulum should behave like a Foucault pendulum. The oscillation plane of the paraconical pendulum however begins to rotate.

b) Allais concludes from his experimental studies that the orbital plane approach always asymptotically to a limiting plane and the effect is only particularly spectacular during the eclipse. During solar eclipse the limiting plane contains the line connecting Earth, Moon, and Sun. Allais explains this in terms of what he calls the anisotropy of space.

c) Some experiments carried out during eclipse have reproduced the findings of Allais, some experiments not. In the experiment carried out by Jeverdan and collaborators in Romania it was found that the period of oscillation of the pendulum decreases by  $\Delta f/f \simeq 5 \times 10^{-4}$  [E2, E18] which happens to correspond to the constant  $v_0 = 2^{-11}$  appearing in the formula of the gravitational Planck constant. It must be however emphasized that the overall magnitude of  $\Delta f/f$  varies by five orders of magnitude. Even the sign of  $\Delta f/f$  varies from experiment to experiment.

d) There is also quite recent finding by Popescu and Olenici, which they interpret as a quantization of the plane of oscillation of paraconical oscillator during solar eclipse [E25] .

#### TGD based models for Allais effect

I have already earlier proposed an explanation of the effect in terms of classical  $Z^0$  force [K7] . If the  $Z^0$  charge to mass ratio of pendulum varies and if Earth and Moon are  $Z^0$  conductors, the resulting model is quite flexible and one might hope it could explain the high variation of the experimental results.

The rapid variation of the effect during the eclipse is however a problem for this approach and suggests that gravitational screening or some more general interference effect might be present. Gravitational screening alone cannot however explain Allais effect.

A model based on the idea that gravitational interaction is mediated by topological light rays (MEs) and that gravitons correspond to a gigantic value of the gravitational Planck constant however explains the Allais effect as an interference effect made possible by macroscopic quantum coherence in astrophysical length scales. Equivalence Principle fixes the model to a high degree and one ends up with an explicit formula for the anomalous gravitational acceleration and the general order of magnitude and the large variation of the frequency change as being due to the variation of the distance ratio  $r_{S,P}/r_{M,P}$  ( $S$ ,  $M$ , and  $P$  refer to Sun, Moon, and pendulum respectively). One can say that the pendulum acts as an interferometer.

### 14.6.6 Applications to elementary particle physics, nuclear physics, and condensed matter physics

The hierarchy of Planck constants could have profound implications for even elementary particle physics since the strong constraints on the existence of new light particles coming from the decay widths of intermediate gauge bosons can be circumvented because direct decays to dark matter are not possible. On the other hand, if light scaled versions of elementary particles exist they must be dark since otherwise their existence would be visible in these decay widths. The constraints on the existence of dark nuclei and dark condensed matter are much milder. Cold fusion and some other anomalies of nuclear and condensed matter physics - in particular the anomalies of water- might have elegant explanation in terms of dark nuclei.

#### Leptohadron hypothesis

TGD suggests strongly the existence of lepto-hadron [?] . Lepto-hadrons are bound states of color excited leptons and the anomalous production of  $e^+e^-$  pairs in heavy ion collisions finds a nice explanation as resulting from the decays of lepto-hadrons with basic condensate level  $k = 127$  and having typical mass scale of one  $MeV$ . The recent indications on the existence of a new fermion with quantum numbers of muon neutrino and the anomaly observed in the decay of ortho-positronium give further support for the lepto-hadron hypothesis. There is also evidence for anomalous production of low energy photons and  $e^+e^-$  pairs in hadronic collisions.

The identification of lepto-hadrons as a particular instance in the predicted hierarchy of dark matters interacting directly only via graviton exchange allows to circumvent the lethal counter arguments against the lepto-hadron hypothesis ( $Z^0$  decay width and production of colored lepton jets in  $e^+e^-$  annihilation) even without assumption about the loss of asymptotic freedom.

PCAC hypothesis and its sigma model realization lead to a model containing only the coupling of the lepto-pion to the axial vector current as a free parameter. The prediction for  $e^+e^-$  production cross section is of correct order of magnitude only provided one assumes that lepto-pions (or electro-pions) decay to lepto-nucleon pair  $e_{ex}^+e_{ex}^-$  first and that lepto-nucleons, having quantum numbers of electron and having mass only slightly larger than electron mass, decay to lepton and photon. The peculiar production characteristics are correctly predicted. There is some evidence that the resonances decay to a final state containing  $n > 2$  particle and the experimental demonstration that lepto-nucleon pairs are indeed in question, would be a breakthrough for TGD.

During 18 years after the first published version of the model also evidence for colored  $\mu$  has emerged [?] . Towards the end of 2008 CDF anomaly [?] gave a strong support for the colored excitation of  $\tau$ . The lifetime of the light long lived state identified as a charged  $\tau$ -pion comes out correctly and the identification of the reported 3 new particles as p-adically scaled up variants of neutral  $\tau$ -pion predicts their masses correctly. The observed muon jets can be understood in terms of the special reaction kinematics for the decays of neutral  $\tau$ -pion to 3  $\tau$ -pions with mass scale smaller by a factor 1/2 and therefore almost at rest. A spectrum of new particles is predicted. The discussion of CDF anomaly [?] led to a modification and generalization of the original model for lepto-pion production and the predicted production cross section is consistent with the experimental estimate.

#### Cold fusion, plasma electrolysis, and burning salt water

The article of Kanarev and Mizuno [D19] reports findings supporting the occurrence of cold fusion in NaOH and KOH hydrolysis. The situation is different from standard cold fusion where heavy water  $D_2O$  is used instead of  $H_2O$ .

In nuclear string model nucleon are connected by color bonds representing the color magnetic body of nucleus and having length considerably longer than nuclear size. One can consider also dark nuclei for which the scale of nucleus is of atomic size [K44] , [K44] . In this framework can understand the cold fusion reactions reported by Mizuno as nuclear reactions in which part of what I call dark proton string having negatively charged color bonds (essentially a zoomed up variant of ordinary nucleus with large Planck constant) suffers a phase transition to ordinary matter and experiences ordinary strong interactions with the nuclei at the cathode. In the simplest model the final state would contain only ordinary nuclear matter. The generation of plasma in plasma electrolysis can be seen as a process analogous to the positive feedback loop in ordinary nuclear reactions.

Rather encouragingly, the model allows to understand also deuterium cold fusion and leads to a solution of several other anomalies.

1. The so called lithium problem of cosmology (the observed abundance of lithium is by a factor 2.5 lower than predicted by standard cosmology [E12] ) can be resolved if lithium nuclei transform partially to dark lithium nuclei.
2. The so called  $H_{1.5}O$  anomaly of water [D6, D5, D10, D27] can be understood if 1/4 of protons of water forms dark lithium nuclei or heavier dark nuclei formed as sequences of these just as ordinary nuclei are constructed as sequences of  ${}^4He$  and lighter nuclei in nuclear string model. The results force to consider the possibility that nuclear isotopes unstable as ordinary matter can be stable dark matter.
3. The mysterious behavior burning salt water [?] can be also understood in the same framework.
4. The model explains the nuclear transmutations observed in Kanarev's plasma electrolysis. This kind of transmutations have been reported also in living matter long time ago [?, ?] . Intriguingly, several biologically important ions belong to the reaction products in the case of NaOH electrolysis. This raises the question whether cold nuclear reactions occur in living matter and are responsible for generation of biologically most important ions.

### 14.6.7 Applications to biology and neuroscience

The notion of field or magnetic body regarded as carrier of dark matter with large Planck constant and quantum controller of ordinary matter is the basic idea in the TGD inspired model of living matter.

#### Do molecular symmetries in living matter relate to non-standard values of Planck constant?

Water is exceptional element and the possibility that  $G_a$  as symmetry of singular factor space of  $CD$  in water and living matter is intriguing.

1. There is evidence for an icosahedral clustering in [?] [?] . Synaptic contacts contain clathrin molecules which are truncated icosahedrons and form lattice structures and are speculated to be involved with quantum computation like activities possibly performed by microtubules. Many viruses have the shape of icosahedron. One can ask whether these structures could be formed around templates formed by dark matter corresponding to 120-fold covering of  $CP_2$  points by  $CD$  points and having  $\hbar(CP_2) = 5\hbar_0$  perhaps corresponding color confined light dark quarks. Of course, a similar covering of  $CD$  points by  $CP_2$  could be involved.
2. It should be noticed that single nucleotide in DNA double strands corresponds to a twist of  $2\pi/10$  per single DNA triplet so that 10 DNA strands corresponding to length  $L(151) = 10$  nm (cell membrane thickness) correspond to  $3 \times 2\pi$  twist. This could be perhaps interpreted as evidence for group  $C_{10}$  perhaps making possible quantum computation at the level of DNA.
3. What makes realization of  $G_a$  as a symmetry of singular factor space of  $CD$  is that the biomolecules most relevant for the functioning of brain (DNA nucleotides, aminoacids acting as neurotransmitters, molecules having hallucinogenic effects) contain aromatic 5- and 6-cycles.

These observations led to an identification of the formula for Planck constant (two alternatives were allowed by the condition that Planck constant is algebraic homomorphism) which was not consistent with the model for dark gravitons. If one accepts the proposed formula of Planck constant, the dark space-time sheets with large Planck constant correspond to factor spaces of both  $\hat{C}D \setminus M^2$  and of  $CP_2 \setminus S_J^2$ . This identification is of course possible and it remains to be seen whether it leads to any problems. For gravitational space-time sheets only coverings of both  $CD$  and  $CP_2$  make sense and the covering group  $G_a$  has very large order and does not correspond to geometric symmetries analogous to those of molecules.

### High $T_c$ super-conductivity in living matter

The model for high  $T_c$  super-conductivity realized as quantum critical phenomenon predicts the basic scales of cell membrane [K13] from energy minimization and p-adic length scale hypothesis. This leads to the vision that cell membrane and possibly also its scaled up dark fractal variants define Josephson junctions generating Josephson radiation communicating information about the nearby environment to the magnetic body.

Any model of high  $T_c$  superconductivity should explain various strange features of high  $T_c$  superconductors. One should understand the high value of  $T_c$ , the ambivalent character of high  $T_c$  superconductors suggesting both BCS type Cooper pairs and exotic Cooper pairs with non-vanishing spin, the existence of pseudogap temperature  $T_{c1} > T_c$  and scaling law for resistance for  $T_c \leq T < T_{c1}$ , the role of fluctuating charged stripes which are anti-ferromagnetic defects of a Mott insulator, the existence of a critical doping, etc... [?, ?].

There are reasons to believe that high  $T_c$  super-conductors correspond to quantum criticality in which at least two (cusp catastrophe as in van der Waals model), or possibly three or even more phases, are competing. A possible analogy is provided by the triple critical point for water vapor, liquid phase and ice coexist. Instead of long range thermal fluctuations long range quantum fluctuations manifesting themselves as fluctuating stripes are present [?].

The TGD based model for high  $T_c$  super-conductivity [K13] relies on the notions of quantum criticality, general ideas of catastrophe theory, dynamical Planck constant, and many-sheeted space-time. The 4-dimensional spin glass character of space-time dynamics deriving from the vacuum degeneracy of the Kähler action defining the basic variational principle would realize space-time correlates for quantum fluctuations.

1. Two kinds of super-conductivities and ordinary non-super-conducting phase would be competing at quantum criticality at  $T_c$  and above it only one super-conducting phase and ordinary conducting phase located at stripes representing ferromagnetic defects making possible formation of  $S = 1$  Cooper pairs.
2. The first super-conductivity would be based on exotic Cooper pairs of large  $\hbar$  dark electrons with  $\hbar = 2^{11}\hbar_0$  and able to have spin  $S = 1$ , angular momentum  $L = 2$ , and total angular momentum  $J = 2$ . Second type of super-conductivity would be based on BCS type Cooper pairs having vanishing spin and bound by phonon interaction. Also they have large  $\hbar$  so that gap energy and critical temperature are scaled up in the same proportion. The exotic Cooper pairs are possible below the pseudo gap temperature  $T_{c1} > T_c$  but are unstable against decay to BCS type Cooper pairs which above  $T_c$  are unstable against a further decay to conduction electrons flowing along stripes. This would reduce the exotic super-conductivity to finite conductivity obeying the observed scaling law for resistance.
3. The mere assumption that electrons of exotic Cooper pairs feed their electric flux to larger space-time sheet via *two* elementary particle sized wormhole contacts rather than only *one* wormhole contacts implies that the throats of wormhole contacts defining analogs of Higgs field must carry quantum numbers of quark and anti-quark. This inspires the idea that cylindrical space-time sheets, the radius of which turns out to be about about 5 nm, representing zoomed up dark electrons of Cooper pair with Planck constant  $\hbar = 2^{11}\hbar_0$  are colored and bound by a scaled up variant of color force to form a color confined state. Formation of Cooper pairs would have nothing to do with direct interactions between electrons. Thus high  $T_c$  super-conductivity could be seen as a first indication for the presence of scaled up variant of QCD in mesoscopic length scales.

This picture leads to a concrete model for high  $T_c$  superconductors as quantum critical superconductors [K13]. p-Adic length scale hypothesis stating that preferred p-adic primes  $p \simeq 2^k$ ,  $k$  integer, with primes (in particular Mersenne primes) preferred, makes the model quantitative.

1. An unexpected prediction is that coherence length  $\xi$  is actually  $\hbar_{eff}/\hbar_0 = 2^{11}$  times longer than the coherence length 5-10 Angstroms deduced theoretically from gap energy using conventional theory and varies in the range 1 – 5  $\mu\text{m}$ , the cell nucleus length scale. Hence type I super-conductor would be in question with stripes as defects of anti-ferromagnetic Mott insulator serving as duals for the magnetic defects of type I super-conductor in nearly critical magnetic field.

2. At quantitative level the model reproduces correctly the four poorly understood photon absorption lines and allows to understand the critical doping ratio from basic principles.
3. The current carrying structures have structure locally similar to that of axon including the double layered structure of cell membrane and also the size scales are predicted to be same. One of the characteristic absorption lines has energy of .05 eV which corresponds to the Josephson energy for neuronal membrane for activation potential  $V = 50$  mV. Hence the idea that axons are high  $T_c$  superconductors is highly suggestive. Dark matter hierarchy coming in powers  $\hbar/\hbar_0 = 2^{k11}$  suggests hierarchy of Josephson junctions needed in TGD based model of EEG [K22] .

### Magnetic body as a sensory perceiver and intentional agent

The hypothesis that dark magnetic body serves as an intentional agent using biological body as a motor instrument and sensory receptor is consistent with Libet's findings about strange time delays of consciousness. Magnetic body would carry cyclotron Bose-Einstein condensates of various ions. Magnetic body must be able to perform motor control and receive sensory input from biological body.

Cell membrane would be a natural sensor providing information about cell interior and exterior to the magnetic body and dark photons at appropriate frequency range would naturally communicate this information. The strange quantitative co-incidences with the physics of cell membrane and high  $T_c$  super-conductivity support the idea that Josephson radiation generated by Josephson currents of dark electrons through cell membrane is responsible for this communication [K22] .

Also fractally scaled up versions of cell membrane at higher levels of dark matter hierarchy (in particular those corresponding to powers  $n = 2^{k11}$ ) are possible and the model for EEG indeed relies on this hypothesis. The thickness for the fractal counterpart of cell membrane thickness would be  $2^{44}$  fold and of order of depth of ionosphere! Although this looks weird it is completely consistent with the notion of magnetic body as an intentional agent.

Motor control would be most naturally performed via genome: this is achieved if flux sheets traverse through DNA strands. Flux quantization for large values of Planck constant requires rather large widths for the flux sheets. If flux sheet contains sequences of genomes like the page of book contains lines of text, a coherent gene expression becomes possible at level of organs and even populations and one can speak about super- and hyper-genomes. Introns might relate to the collective gene expression possibly realized electromagnetically rather than only chemically [K13, K14] .

Dark cyclotron radiation with photon energy above thermal energy could be used for coordination purposes at least. The predicted hierarchy of copies of standard model physics leads to ask whether also dark copies of electro-weak gauge bosons and gluons could be important in living matter. As already mentioned, dark  $W$  bosons could make possible charge entanglement and non-local quantum bio-control by inducing voltage differences and thus ionic currents in living matter.

The identification of plasmoids as rotating magnetic flux structures carrying dark ions and electrons as primitive life forms is natural in this framework. There exists experimental support for this identification [I32] but the main objection is the high temperature involved: this objection could be circumvented if large  $\hbar$  phase is involved. A model for the pre-biotic evolution relying also on this idea is discussed in [K26] .

At the level of biology there are now several concrete applications leading to a rich spectrum of predictions. Magnetic flux quanta would carry charged particles with large Planck constant.

1. The shortening of the flux tubes connecting biomolecules in a phase transition reducing Planck constant could be a basic mechanism of bio-catalysis and explain the mysterious ability of biomolecules to find each other. Similar process in time direction could explain basic aspects of symbolic memories as scaled down representations of actual events.
2. The strange behavior of cell membrane suggests that a dominating portion of important biological ions are actually dark ions at magnetic flux tubes so that ionic pumps and channels are needed only for visible ions. This leads to a model of nerve pulse explaining its unexpected thermodynamical properties with basic properties of Josephson currents making it un-necessary to use pumps to bring ions back after the pulse. The model predicts automatically EEG as Josephson radiation and explains the synchrony of both kHz radiation and of EEG.



3. The DC currents of Becker could be accompanied by Josephson currents running along flux tubes making possible dissipation free energy transfer and quantum control over long distances and meridians of chinese medicine could correspond to these flux tubes.
4. The model of DNA as topological quantum computer assumes that nucleotides and lipids are connected by ordinary or "wormhole" magnetic flux tubes acting as strands of braid and carrying dark matter with large Planck constant. The model leads to a new vision about TGD in which the assignment of nucleotides to quarks allows to understand basic regularities of DNA not understood from biochemistry.
5. Each physical system corresponds to an onionlike hierarchy of field bodies characterized by p-adic primes and value of Planck constant. The highest value of Planck constant in this hierarchy provides kind of intelligence quotient characterizing the evolutionary level of the system since the time scale of planned action and memory correspond to the temporal distance between tips of corresponding causal diamond ( $CD$ ). Also the spatial size of the system correlates with the Planck constant. This suggests that great evolutionary leaps correspond to the increase of Planck constant for the highest level of hierarchy of personal magnetic bodies. For instance, neurons would have much more evolved magnetic bodies than ordinary cells.
6. At the level of DNA this vision leads to an idea about hierarchy of genomes. Magnetic flux sheets traversing DNA strands provide a natural mechanism for magnetic body to control the behavior of biological body by controlling gene expression. The quantization of magnetic flux states that magnetic flux is proportional to  $\hbar$  and thus means that the larger the value of  $\hbar$  is the larger the width of the flux sheet is. For larger values of  $\hbar$  single genome is not enough to satisfy this condition. This leads to the idea that the genomes of organs, organism, and even population, can organize like lines of text at the magnetic flux sheets and form in this manner a hierarchy of genomes responsible for a coherent gene expression at level of cell, organ, organism and population and perhaps even entire biosphere. This would also provide a mechanism by which collective consciousness would use its biological body - biosphere.

### DNA as topological quantum computer

I ended up with the recent model of tqc in bottom-up manner and this representation is followed also in the text. The model which looks the most plausible one relies on two specific ideas.

1. Sharing of labor means conjugate DNA would do tqc and DNA would "print" the outcome of tqc in terms of mRNA yielding amino-acids in the case of exons. RNA could result also in the case of introns but not always. The experience about computers and the general vision provided by TGD suggests that introns could express the outcome of tqc also electromagnetically in terms of standardized field patterns as Gariaev's findings suggest [I23]. Also speech would be a form of gene expression. The quantum states braid (in zero energy ontology) would entangle with characteristic gene expressions. This argument turned out to be based on a slightly wrong belief about DNA: later I learned that both strand and its conjugate are transcribed but in different directions. The symmetry breaking in the case of transcription is only local which is also visible in DNA replication as symmetry breaking between leading and lagging strand. Thus the idea about *entire* leading strand devoted to printing and second strand to tqc must be weakened appropriately.
2. The manipulation of braid strands transversal to DNA must take place at 2-D surface. Here dancing metaphor for topological quantum computation [?] generalizes. The ends of the space-like braid are like dancers whose feet are connected by thin threads to a wall so that the dancing pattern entangles the threads. Dancing pattern defines both the time-like braid, the running of classical tqc program and its representation as a dynamical pattern. The space-like braid defined by the entangled threads represents memory storage so that tqc program is automatically written to memory as the braiding of the threads during the tqc. The inner membrane of the nuclear envelope and cell membrane with entire endoplasmic reticulum included are good candidates for dancing halls. The 2-surfaces containing the ends of the hydrophobic ends of lipids could be the parquets and lipids the dancers. This picture seems to make sense.

One ends up to the model also in top-down manner.

1. Darwinian selection for which standard theory of self-organization [?] provides a model, should apply also to tqc programs. Tqc programs should correspond to asymptotic self-organization patterns selected by dissipation in the presence of metabolic energy feed. The spatial and temporal pattern of the metabolic energy feed characterizes the tqc program - or equivalently - sub-program call.
2. Since braiding characterizes the tqc program, the self-organization pattern should correspond to a hydrodynamical flow or a pattern of magnetic field inducing the braiding. Braid strands must correspond to magnetic flux tubes of the magnetic body of DNA. If each nucleotide is transversal magnetic dipole it gives rise to transversal flux tubes, which can also connect to the genome of another cell.
3. The output of tqc sub-program is probability distribution for the outcomes of state function reduction so that the sub-program must be repeated very many times. It is represented as four-dimensional patterns for various rates (chemical rates, nerve pulse patterns, EEG power distributions,...) having also identification as temporal densities of zero energy states in various scales. By the fractality of TGD Universe there is a hierarchy of tqc's corresponding to p-adic and dark matter hierarchies. Programs (space-time sheets defining coherence regions) call programs in shorter scale. If the self-organizing system has a periodic behavior each tqc module defines a large number of almost copies of itself asymptotically. Generalized EEG could naturally define this periodic pattern and each period of EEG would correspond to an initiation and halting of tqc. This brings in mind the periodically occurring sol-gel phase transition inside cell near the cell membrane.
4. Fluid flow must induce the braiding which requires that the ends of braid strands must be anchored to the fluid flow. Recalling that lipid mono-layers of the cell membrane are liquid crystals and lipids of interior mono-layer have hydrophilic ends pointing towards cell interior, it is easy to guess that DNA nucleotides are connected to lipids by magnetic flux tubes and hydrophilic lipid ends are stuck to the flow.
5. The topology of the braid traversing cell membrane cannot be affected by the hydrodynamical flow. Hence braid strands must be split during tqc. This also induces the desired magnetic isolation from the environment. Halting of tqc reconnects them and makes possible the communication of the outcome of tqc.
6. There are several problems related to the details of the realization. How nucleotides A,T,C,G are coded to strand color and what this color corresponds to? The prediction that wormhole contacts carrying quark and anti-quark at their ends appear in all length scales in TGD Universe resolves the problem. How to split the braid strands in a controlled manner? High  $T_c$  super conductivity provides a partial understanding of the situation: braid strand can be split only if the supra current flowing through it vanishes. From the proportionality of Josephson current to the quantity  $\sin(\int 2eV dt)$  it follows that a suitable voltage pulse  $V$  induces DC supra-current and its negative cancels it. The conformation of the lipid controls whether it can follow the flow or not. How magnetic flux tubes can be cut without breaking the conservation of the magnetic flux? The notion of wormhole magnetic field saves the situation now: after the splitting the flux returns back along the second space-time sheet of wormhole magnetic field.

To sum up, it seems that essentially all new physics involved with TGD based view about quantum biology enter to the model in crucial manner.

### Quantum model of nerve pulse and EEG

In this article a unified model of nerve pulse and EEG is discussed.

1. In TGD Universe the function of EEG and its variants is to make possible communications from the cell membrane to the magnetic body and the control of the biological body by the magnetic body via magnetic flux sheets traversing DNA by inducing gene expression. This leads to the notions of super- and hyper-genome predicting coherent gene expression at level of organs and population.

2. The assignment the predicted ranged classical weak and color gauge fields to dark matter hierarchy was a crucial step in the evolution of the model, and led among other things to a model of high  $T_c$  superconductivity predicting the basic scales of cell, and also to a generalization of EXG to a hierarchy of ZXGs, WXGs, and GXGs corresponding to  $Z^0$ ,  $W$  bosons and gluons.
3. Dark matter hierarchy and the associated hierarchy of Planck constants plays a key role in the model. For instance, in the case of EEG Planck constant must be so large that the energies of dark EEG photons are above thermal energy at physiological temperatures. The assumption that a considerable fraction of the ionic currents through the cell membrane are dark currents flowing along the magnetic flux tubes explains the strange findings about ionic currents through cell membrane. Concerning the model of nerve pulse generation, the newest input comes from the model of DNA as a topological quantum computer and experimental findings challenging Hodgkin-Huxley model as even approximate description of the situation.
4. The identification of the cell interior as gel phase containing most of water as structured water around cytoskeleton - rather than water containing bio-molecules as solutes as assumed in Hodgkin-Huxley model - allows to understand many of the anomalous behaviors associated with the cell membrane and also the different densities of ions in the interior and exterior of cell at qualitative level. The proposal of Pollack that basic biological functions involve phase transitions of gel phase generalizes in TGD framework to a proposal that these phase transitions are induced by quantum phase transitions changing the value of Planck constant. In particular, gel-sol phase transition for the peripheral cytoskeleton induced by the primary wave would accompany nerve pulse propagation. This view about nerve pulse is not consistent with Hodgkin-Huxley model.

The model leads to the following picture about nerve pulse and EEG.

1. The system would consist of two superconductors- microtubule space-time sheet and the space-time sheet in cell exterior- connected by Josephson junctions represented by magnetic flux tubes defining also braiding in the model of tqc. The phase difference between two super-conductors would obey Sine-Gordon equation allowing both standing and propagating solitonic solutions. A sequence of rotating gravitational penduli coupled to each other would be the mechanical analog for the system. Soliton sequences having as a mechanical analog penduli rotating with constant velocity but with a constant phase difference between them would generate moving kHz synchronous oscillation. Periodic boundary conditions at the ends of the axon rather than chemistry determine the propagation velocities of kHz waves and kHz synchrony is an automatic consequence since the times taken by the pulses to travel along the axon are multiples of same time unit. Also moving oscillations in EEG range can be considered and would require larger value of Planck constant in accordance with vision about evolution as gradual increase of Planck constant.
2. During nerve pulse one pendulum would be kicked so that it would start to oscillate instead of rotating and this oscillation pattern would move with the velocity of kHz soliton sequence. The velocity of kHz wave and nerve pulse is fixed by periodic boundary conditions at the ends of the axon implying that the time spent by the nerve pulse in traveling along axon is always a multiple of the same unit: this implies kHz synchrony. The model predicts the value of Planck constant for the magnetic flux tubes associated with Josephson junctions and the predicted force caused by the ionic Josephson currents is of correct order of magnitude for reasonable values of the densities of ions. The model predicts kHz em radiation as Josephson radiation generated by moving soliton sequences. EEG would also correspond to Josephson radiation: it could be generated either by moving or standing soliton sequences (latter are naturally assignable to neuronal cell bodies for which  $\hbar$  should be correspondingly larger): synchrony is predicted also now.

## 14.7 Appendix

### 14.7.1 About inclusions of hyper-finite factors of type II<sub>1</sub>

Many names have been assigned to inclusions: Jones, Wenzl, Ocneacnu, Pimsner-Popa, Wasserman [?] . It would seem to me that the notion Jones inclusion includes them all so that various names would

correspond to different concrete realizations of the inclusions conjugate under outer automorphisms.

1. According to [?] for inclusions with  $\mathcal{M} : \mathcal{N} \leq 4$  (with  $A_1^{(1)}$  excluded) there exists a countable infinity of sub-factors which are pairwise non inner conjugate but conjugate to  $\mathcal{N}$ .
2. Also for any finite group  $G$  and its outer action there exists uncountably many sub-factors which are pairwise non inner conjugate but conjugate to the fixed point algebra of  $G$  [?]. For any amenable group  $G$  the inclusion is also unique apart from outer automorphism [?].

Thus it seems that not only Jones inclusions but also more general inclusions are unique apart from outer automorphism.

Any \*-endomorphism  $\sigma$ , which is unit preserving, faithful, and weakly continuous, defines a sub-factor of type  $II_1$  factor [?]. The construction of Jones leads to a standard inclusion sequence  $\mathcal{N} \subset \mathcal{M} \subset \mathcal{M}^1 \subset \dots$ . This sequence means addition of projectors  $e_i, i < 0$ , having visualization as an addition of braid strand in braid picture. This hierarchy exists for all factors of type II. At the limit  $\mathcal{M}^\infty = \cup_i \mathcal{M}^i$  the braid sequence extends from  $-\infty$  to  $\infty$ . Inclusion hierarchy can be understood as a hierarchy of Connes tensor powers  $\mathcal{M} \otimes_{\mathcal{N}} \mathcal{M} \dots \otimes_{\mathcal{N}} \mathcal{M}$ . Also the ordinary tensor powers of hyper-finite factors of type  $II_1$  (HFF) as well as their tensor products with finite-dimensional matrix algebras are isomorphic to the original HFF so that these objects share the magic of fractals.

Under certain assumptions the hierarchy can be continued also in opposite direction. For a finite index an infinite inclusion hierarchy of factors results with the same value of index.  $\sigma$  is said to be basic if it can be extended to \*-endomorphisms from  $\mathcal{M}^1$  to  $\mathcal{M}$ . This means that the hierarchy of inclusions can be continued in the opposite direction: this means elimination of strands in the braid picture. For finite factors (as opposed to hyper-finite ones) there are no basic \*-endomorphisms of  $\mathcal{M}$  having fixed point algebra of non-abelian  $G$  as a sub-factor [?].

1. Jones inclusions

For hyper-finite factors of type  $II_1$  Jones inclusions allow basic \*-endomorphism. They exist for all values of  $\mathcal{M} : \mathcal{N} = r$  with  $r \in \{4\cos^2(\pi/n) | n \geq 3\} \cap [4, \infty)$  [?]. They are defined for an algebra defined by projectors  $e_i, i \geq 1$ . All but nearest neighbor projectors commute.  $\lambda = 1/r$  appears in the relations for the generators of the algebra given by  $e_i e_j e_i = \lambda e_i, |i - j| = 1$ .  $\mathcal{N} \subset \mathcal{M}$  is identified as the double commutator of algebra generated by  $e_i, i \geq 2$ .

This means that principal graph and its dual are equivalent and the braid defined by projectors can be continued not only to  $-\infty$  but that also the dropping of arbitrary number of strands is possible [?]. It would seem that ADE property of the principal graph meaning single root length codes for the duality in the case of  $r \leq 4$  inclusions.

Irreducibility holds true for  $r < 4$  in the sense that the intersection of  $Q' \cap P = P' \cap P = C$ . For  $r \geq 4$  one has  $dim(Q' \cap P) = 2$ . The operators commuting with  $Q$  contain besides identify operator of  $Q$  also the identify operator of  $P$ .  $Q$  would contain a single finite-dimensional matrix factor less than  $P$  in this case. Basic \*-endomorphisms with  $\sigma(P) = Q$  is  $\sigma(e_i) = e_{i+1}$ . The difference between genuine symmetries of quantum TGD and symmetries which can be mimicked by TGD could relate to the irreducibility for  $r < 4$  and raise these inclusions in a unique position. This difference could partially justify the hypothesis that only the groups  $G_a \times G_b \subset SU(2) \times SU(2) \subset SL(2, C) \times SU(3)$  define orbifold coverings of  $H_{\pm} = CD \times CP_2 \rightarrow H_{\pm}/G_a \times G_b$ .

2. Wasserman's inclusion

Wasserman's construction of  $r = 4$  factors clarifies the role of the subgroup of  $G \subset SU(2)$  for these inclusions. Also now  $r = 4$  inclusion is characterized by a discrete subgroup  $G \subset SU(2)$  and is given by  $(1 \otimes \mathcal{M})^G \subset (M_2(C) \times \mathcal{M})^G$ . According to [?] Jones inclusions are irreducible also for  $r = 4$ . The definition of Wasserman inclusion for  $r = 4$  seems however to imply that the identity matrices of both  $M^G$  and  $(M(2, C) \otimes \mathcal{M})^G$  commute with  $M^G$  so that the inclusion should be reducible for  $r = 4$ .

Note that  $G$  leaves both the elements of  $\mathcal{N}$  and  $\mathcal{M}$  invariant whereas  $SU(2)$  leaves the elements of  $\mathcal{N}$  invariant.  $M(2, C)$  is effectively replaced with the orbifold  $M(2, C)/G$ , with  $G$  acting as automorphisms. The space of these orbits has complex dimension  $d = 4$  for finite  $G$ .

For  $r < 4$  inclusion is defined as  $M^G \subset M$ . The representation of  $G$  as outer automorphism must change step by step in the inclusion sequence  $\dots \subset \mathcal{N} \subset \mathcal{M} \subset \dots$  since otherwise  $G$  would act trivially

as one proceeds in the inclusion sequence. This is true since each step brings in additional finite-dimensional tensor factor in which  $G$  acts as automorphisms so that although  $\mathcal{M}$  can be invariant under  $G_{\mathcal{M}}$  it is not invariant under  $G_{\mathcal{N}}$ .

These two inclusions might accompany each other in TGD based physics. One could consider  $r < 4$  inclusion  $\mathcal{N} = \mathcal{M}^G \subset \mathcal{M}$  with  $G$  acting non-trivially in  $\mathcal{M}/\mathcal{N}$  quantum Clifford algebra.  $\mathcal{N}$  would decompose by  $r = 4$  inclusion to  $\mathcal{N}_1 \subset \mathcal{N}$  with  $SU(2)$  taking the role of  $G$ .  $\mathcal{N}/\mathcal{N}_1$  quantum Clifford algebra would transform non-trivially under  $SU(2)$  but would be  $G$  singlet.

In TGD framework the  $G$ -invariance for  $SU(2)$  representations means a reduction of  $S^2$  to the orbifold  $S^2/G$ . The coverings  $H_{\pm} \rightarrow H_{\pm}/G_a \times G_b$  should relate to these double inclusions and  $SU(2)$  inclusion could mean Kac-Moody type gauge symmetry for  $\mathcal{N}$ . Note that the presence of the factor containing only unit matrix should relate directly to the generator  $d$  in the generator set of affine algebra in the McKay construction. The physical interpretation of the fact that almost all ADE type extended diagrams ( $D_n^{(1)}$  must have  $n \geq 4$ ) are allowed for  $r = 4$  inclusions whereas  $D_{2n+1}$  and  $E_6$  are not allowed for  $r < 4$ , remains open.

### 14.7.2 Generalization from $SU(2)$ to arbitrary compact group

The inclusions with index  $\mathcal{M} : \mathcal{N} < 4$  have one-dimensional relative commutant  $\mathcal{N}' \cup \mathcal{M}$ . The most obvious conjecture that  $\mathcal{M} : \mathcal{N} \geq 4$  corresponds to a non-trivial relative commutant is wrong. The index for Jones inclusion is identifiable as the square of quantum dimension of the fundamental representation of  $SU(2)$ . This identification generalizes to an arbitrary representation of arbitrary compact Lie group.

In his thesis Wenzl [?] studied the representations of Hecke algebras  $H_n(q)$  of type  $A_n$  obtained from the defining relations of symmetric group by the replacement  $e_i^2 = (q-1)e_i + q$ .  $H_n$  is isomorphic to complex group algebra of  $S_n$  if  $q$  is not a root of unity and for  $q = 1$  the irreducible representations of  $H_n(q)$  reduce trivially to Young's representations of symmetric groups. For primitive roots of unity  $q = \exp(i2\pi/l)$ ,  $l = 4, 5, \dots$ , the representations of  $H_n(\infty)$  give rise to inclusions for which index corresponds to a quantum dimension of any irreducible representation of  $SU(k)$ ,  $k \geq 2$ . For  $SU(2)$  also the value  $l = 3$  is allowed for spin 1/2 representation.

The inclusions are obtained by dropping the first  $m$  generators  $e_k$  from  $H_{\infty}(q)$  and taking double commutant of both  $H_{\infty}$  and the resulting algebra. The relative commutant corresponds to  $H_m(q)$ . By reducing by the minimal projection to relative commutant one obtains an inclusion with a trivial relative commutant. These inclusions are analogous to a discrete states superposed in continuum. Thus the results of Jones generalize from the fundamental representation of  $SU(2)$  to all representations of all groups  $SU(k)$ , and in fact to those of general compact groups as it turns out.

The generalization of the formula for index to square of quantum dimension of an irreducible representation of  $SU(k)$  reads as

$$\mathcal{M} : \mathcal{N} = \prod_{1 \leq r < s \leq k} \frac{\sin^2((\lambda_r - \lambda_s + s - r)\pi/l)}{\sin^2((s - r)n/l)}. \tag{14.7.1}$$

Here  $\lambda_r$  is the number of boxes in the  $r^{th}$  row of the Yang diagram with  $n$  boxes characterizing the representations and the condition  $1 \leq k \leq l - 1$  holds true. Only Young diagrams satisfying the condition  $l - k = \lambda_1 - \lambda_{r_{max}}$  are allowed.

The result would allow to restrict the generalization of the imbedding space in such a manner that only cyclic group  $Z_n$  appears in the covering of  $M^4 \rightarrow M^4/G_a$  or  $CP_2 \rightarrow CP_2/G_b$  factor. Be as it may, it seems that quantum representations of any compact Lie group can be realized using the generalization of the imbedding space. In the case of  $SU(2)$  the interpretation of higher-dimensional quantum representations in terms of Connes tensor products of 2-dimensional fundamental representations is highly suggestive.

The groups  $SO(3, 1) \times SU(3)$  and  $SL(2, C) \times U(2)_{ew}$  have a distinguished position both in physics and quantum TGD and the vision about physics as a generalized number theory implies them. Also the general pattern for inclusions selects these groups, and one can say that the condition that all possible statistics are realized is guaranteed by the choice  $M^4 \times CP_2$ .

1.  $n > 2$  for the quantum counterparts of the fundamental representation of  $SU(2)$  means that braid statistics for Jones inclusions cannot give the usual fermionic statistics. That Fermi

statistics cannot "emerge" conforms with the role of infinite- $D$  Clifford algebra as a canonical representation of HFF of type  $II_1$ .  $SO(3, 1)$  as isometries of  $H$  gives  $Z_2$  statistics via the action on spinors of  $M^4$  and  $U(2)$  holonomies for  $CP_2$  realize  $Z_2$  statistics in  $CP_2$  degrees of freedom.

2.  $n > 3$  for more general inclusions in turn excludes  $Z_3$  statistics as braid statistics in the general case.  $SU(3)$  as isometries induces a non-trivial  $Z_3$  action on quark spinors but trivial action at the imbedding space level so that  $Z_3$  statistics would be in question.

# Mathematics

- [A1] Gaussian Mersenne. <http://primes.utm.edu/glossary/xpage/GaussianMersenne.html>.
- [A2] Z. I. Borevich and I. R. Shafarevich. *Number Theory*. Academic Press, 1966.
- [A3] Eisenhart. *Riemannian Geometry*. Princeton University Press, 1964.
- [A4] C. N. Pope G. W. Gibbons.  $CP_2$  as gravitational instanton. *Comm. Math. Phys.*, 55, 1977.
- [A5] W. Hawking, S. and N. Pope, C. Generalized Spin Structures in Quantum Gravity. *Phys. Lett.*, (1), 1978.
- [A6] S. Helgason. *Differential Geometry and Symmetric Spaces*. Academic Press, New York, 1962.
- [A7] C. Itzykson and J-B. Zuber. *Quantum Field Theory*, volume 549. Mc Graw-Hill, New York, 1980.
- [A8] J. Milnor. *Topology form Differential Point of View*. The University Press of Virginia, Virginia, 1965.
- [A9] D. S. Moak. The q-analogue of the Laguerre polynomials. *J. Math. Anal. Appl.*, 81, 1981.
- [A10] N. Pope, C. Eigenfunctions and  $Spin^c$  Structures on  $CP_2$ , 1980.
- [A11] B. Shipman. The geometry of momentum mappings on generalized flag manifolds, connections with a dynamical system, quantum mechanics and the dance of honeybee. <http://math.cornell.edu/~oliver/Shipman.gif>, 1998.
- [A12] M. Spivak. *Differential Geometry I,II,III,IV*. Publish or Perish, Boston, 1970.
- [A13] J. Hanson T. Eguchi, B. Gilkey. *Phys. Rep.*, 66:1980, 1980.
- [A14] R. Thom. *Commentarii Math. Helvet.*, 28, 1954.
- [A15] Wallace. *Differential Topology*. W. A. Benjamin, New York, 1968.
- [A16] E. C. Zeeman. *Catastrophe Theory*. Addison-Wessley Publishing Company, 1977.





# Theoretical Physics

- [B1] J. Björken and S. Drell. *Relativistic Quantum Fields*. Mc Graw-Hill, New York, 1965.
- [B2] K. Huang. *Quarks, Leptons & Gauge Fields*. World Scientific, 1982.
- [B3] R. Kiehn. Electromagnetic waves in vacuum with torsion and spin. <http://www22.pair.com/csdc/pdf/helical6.pdf>.
- [B4] G. Parisi. *Field Theory, Disorder and Simulations*. World Scientific, 1992.
- [B5] A. Zee. *The Unity of Forces in the Universe*. World Science Press, Singapore, 1982.



# Particle and Nuclear Physics

- [C1] Giant Dipole Resonance: What is Known About? <http://cdfc.sinp.msu.ru/publications/lshkhv-ELI03.pdf>.
- [C2] Abragam A. *The principles of nuclear magnetism*. Clarendon Press, Oxford, 1961.
- [C3] C. Rolfs et al. First hints on a change of the  $^{22}\text{Na}$  beta decay half-life in the metal Pd. *Eur. Phys. J. A*, 28, 2006.
- [C4] C. Rolfs et al. High-Z electron screening, the cases  $^{50}\text{V}(\text{p},\text{n})^{50}$ . *Eur. Phys. J. A*, 28, 2006.
- [C5] G. Tertuchny et al. Microscopic description of the pygmy and giant electric dipole resonances in stable Ca isotopes. <http://arxiv.org/abs/nucl-th/0603/0603051>, 2006.
- [C6] S. E. Shnoll et al. Realization of discrete states during fluctuations in macroscopic processes. *Uspekhi Fisicheskikh Nauk*, 41(10):1025–1035, 1998.
- [C7] V. M. Lobashev et al. In *Neutrino 96*, Singapore, 1996. World Scientific.
- [C8] K. Langanke H. J. Assenbaum and C. Rolfs. *Z. Phys. A*, 327, 1987.
- [C9] A. D. Krisch. The spin of proton. *Scientific American*, May 1979.
- [C10] M. T. Ressel and M. S. Turner. *Astrophys.*, 14, 1990.
- [C11] C. Rolfs and W. S. Rodney. *Cauldrons in the Cosmos*. University of Chicago Press, Chicago, 1988.



# Condensed Matter Physics

- [D1] Fractional quantum Hall Effect. [http://en.wikipedia.org/wiki/Fractional\\_quantum\\_Hall\\_effect](http://en.wikipedia.org/wiki/Fractional_quantum_Hall_effect).
- [D2] Hydrogen bonds. [http://en.wikipedia.org/wiki/Hydrogen\\_bond](http://en.wikipedia.org/wiki/Hydrogen_bond).
- [D3] Phase conjugation. <http://www.usc.edu/dept/ee/People/Faculty/feinberg.html>.
- [D4] O. Balcou and L. Durtriaux. *Phys. Rev.*, 78, 1997.
- [D5] J. K. Borhardt. The chemical formula H<sub>2</sub>O - a misnomer. *The Alchemist*, August 2003.
- [D6] M. Chaplin. Water Structure and Behavior. <http://www.lsbu.ac.uk/water/index.html>, 2005.
- [D7] R. Y. Chiao. Super-conductors as transducers and antennas for gravitational and electromagnetic radiation. <http://arxiv.org/abs/gr-gc/0204012>.
- [D8] R. Y. Chiao. Tunnelling Times and Super-luminality: a Tutorial, November 1998.
- [D9] R. Y. Chiao and A. M. Steinberg. In E. Wolf, editor, *Progress in Optics XXXVII*, volume 345, Amsterdam, 1997. Elsevier.
- [D10] R. A. Cowley. Neutron-scattering experiments and quantum entanglement. *Physica B*, 350:243–245, 2004.
- [D11] D. J. Evans et al. Experimental Demonstration of Violations of the Second Law of Thermodynamics for Small Systems and Short Time Scales. *Phys. Rev.*, 89, 2002.
- [D12] G. A. Melkov et al. *Phase Conjugation of Linear and Nonlinear Signals of Magnetostatic Waves*. Trans Tech Publications, Switzerland, 2001.
- [D13] G. Nimtz et al. *J. Phys.*, 4, 1994.
- [D14] J. B. Miller et al. Fractional Quantum Hall effect in a quantum point contact at filling fraction  $5/2$ . <http://arxiv.org/abs/cond-mat/0703161v2>, 2007.
- [D15] R. Mills et al. Spectroscopic and NMR identification of novel hybrid ions in fractional quantum energy states formed by an exothermic reaction of atomic hydrogen with certain catalysts. <http://www.blacklightpower.com/techpapers.html>, 2003.
- [D16] S. M. Girvin. Quantum Hall Effect, Novel Excitations and Broken Symmetries. <http://arxiv.org/abs/cond-mat/9907002>, 1999.
- [D17] J.K. Jain. *Phys. Rev.*, 63, 1989.
- [D18] P. Kanarev. Water is New Source of Energy. *Krasnodar*, 2002.
- [D19] P. Kanarev and T. Mizuno. Cold fusion by plasma electrolysis of water. <http://www.guns.connect.fi/innoplaza/energy/story/Kanarev/codlfusion/>, 2002.
- [D20] I. Langmuir. *Journal of American Chemical Society*, 37, 1915.
- [D21] R. B. Laughlin. *Phys. Rev.*, 50, 1990.

- [D22] J-C. Li and D.K. Ross. Evidence of Two Kinds of Hydrogen Bonds in Ices. *Nature*, 365:327–329, 1993.
- [D23] R. Mackenzie and F. Wilczek. *Rev. Mod. Phys. A*, 3:2827, 1988.
- [D24] S. Meyer. Water Fuel Cell. International News Release, No. 11 A-Rv., 1996.
- [D25] D. M. Pepper. Nonlinear Optical Phase Conjugation. *Optical Engineering*, 21(2), March 1982.
- [D26] H. Puthoff. Ground State of Hydrogen as a Zero-Point Fluctuation Determined State. *Phys. Rev. D*, 35, 1987.
- [D27] Y. Danon R. Moreh, R. C. Block and M. Neumann. Search for anomalous scattering of keV neutrons from H<sub>2</sub>O-D<sub>2</sub>O mixtures. *Phys. Rev.*, 94, 2005.
- [D28] V. V. Shkunov and B. Ya. Zeldovich. Optical Phase Conjugation. *Scientific American*, 1985.
- [D29] D. D. Stancil. *Theory of Magnetostatic Waves*. Springer Verlag, 1993.
- [D30] A. M. Steinberg and R. Y. Chiao. Sub-femtosecond determination of transmission delay times for a dielectric mirror (photonic bandgap) as a function of angle of incidence. <http://arxiv.org/abs/quant-ph/9501013>, 1995.
- [D31] L. Wang. *Nature*, July 2000.
- [D32] Pollack G. Zheng, Jian-ming. Long-range forces extending from polymer-gel surfaces. <http://arxiv.org/abs/cond-mat/0305093>, 2003.

# Cosmology and Astro-Physics

- [E1] Age of the universe. [http://en.wikipedia.org/wiki/Age\\_of\\_the\\_universe](http://en.wikipedia.org/wiki/Age_of_the_universe).
- [E2] Allais effect. [http://en.wikipedia.org/wiki/Allais\\_effect](http://en.wikipedia.org/wiki/Allais_effect).
- [E3] Cavendish experiment. [http://en.wikipedia.org/wiki/Cavendish\\_experiment](http://en.wikipedia.org/wiki/Cavendish_experiment).
- [E4] French Nobel Laureate turns back clock. [http://science.nasa.gov/newhome/headlines/ast12oct99\\_1.htm](http://science.nasa.gov/newhome/headlines/ast12oct99_1.htm).
- [E5] French Nobel Laureate turns back clock: Marshall's global experiment, von Braun memories evoked during August 11 solar eclipse. [http://science.nasa.gov/newhome/headlines/ast12oct99\\_1.htm](http://science.nasa.gov/newhome/headlines/ast12oct99_1.htm).
- [E6] Rings of Saturn. [http://en.wikipedia.org/wiki/Rings\\_of\\_Saturn](http://en.wikipedia.org/wiki/Rings_of_Saturn).
- [E7] Saturn. <http://en.wikipedia.org/wiki/Saturn>.
- [E8] Saturnus. <http://en.wikipedia.org/wiki/Saturn>.
- [E9] M. Allais. Should the Laws of Gravitation be modified?: Part I -Abnormalities in the Motion of a Paraconical Pendulum with Anisotropic Support. *Aero/Space Engineering*, 1959, 1959.
- [E10] M. Allais. Should the Laws of Gravitation be modified?: Part II -Experiments in Connection with the Abnomralities the Motion of a Paraconical Pendulum with an Isotropic Support. *Aero/Space Engineering*, October 1959.
- [E11] M. Allais. Should the Laws of Gravitation Be Reconsidered: Part I,II,III? <http://home.t01.itscom.net/allais/blackprior/allais/lawgravit/lawgrav-one.pdf>, 1959.
- [E12] C. Charbonnel and F. Primas. The lithium content of the Galactic Halo stars. <http://arxiv.org/abs/astro-ph/0505247>, 2005.
- [E13] A. E. Nelson E. G. Adelberger, B. R. Heckel. Tests of Gravitational Inverse-Square Law. <http://www.npl.washington.edu/eotwash/pdf/review.pdf>, 2005.
- [E14] J. A. Eddy and A. A. Boornazian. Secular decrease in the solar diameter. *Bulletin of the American Astronomical Society*, 11(437):1863–1953, 1979.
- [E15] I. Mihaila et al. A new confirmation of the Allais effect during the solar eclipse of 31 2003 May. <http://home.t01.itscom.net/allais/blackprior/mihaila/2003/mihaila2003.pdf>, 2003.
- [E16] Qian-Shen Wang et al. Precise measurement of gravity variations during a total solar eclipse. *Phys. Rev. D*. <http://home.t01.itscom.net/allais/blackprior/wang/wangetal.pdf>, 62, 2000.
- [E17] S. E. Shnoll et al. Realization of discrete fluctuations in macroscopic processes. *Physics-Uspekhi*. <http://home.t01.itscom.net/allais/blackprior/shnoll/shnoll-1.pdf>, 41(10):1025–1035, 1998.
- [E18] G. I. Rusu G. T. Jeverdan and V. Antonescu. Experiments using the Foucault pendulum during the solar eclipse of 15 February, 1961. *Biblical Astronomer*, 1(55), 1981.

- [E19] G. T. Gilles. *American J. of Physics*, 58, 1990.
- [E20] R. L. Gilliland. Solar radius variations over the past 265 years. *Astrophysical Journal*, 248:1155, 1981.
- [E21] Gia Dvali Nima Arkani-Hamed, Savas Dimopoulos. The Hierarchy Problem and New Dimensions at a Millimeter. <http://arxiv.org/abs/hep-ph/9803315>, 1998.
- [E22] M. Holman R. Malhotra and T. Ito. Chaos and stability of the solar system. *Proc. Natl. Acad. Sci. USA*. <http://www.pubmedcentral.nih.gov/articlerender.fcgi?artid=60054>, 98:12342–12343, October 2001.
- [E23] D. Da Roacha and L. Nottale. Gravitational Structure Formation in Scale Relativity. <http://arxiv.org/abs/astro-ph/0310036>, 2003.
- [E24] R. N. Tran U. E. Kruse. Cavendish experiment. <http://www.ccsr.uiuc.edu/~alfred/Ph101/Notes.htm/cavendish/index.html>, 1995.
- [E25] D. Olenici V. A. Popescu. A confirmation of the Allais and Jeverdan-Rusu-Antonescu effects during the solar eclipse from 22 September 2006, and the quantization behavior of pendulum. <http://www.hessdalen.org/sse/program/Articol.pdf>, 2007.



# Physics of Earth

- [F1] Tides. <http://en.wikipedia.org/wiki/Tides>.
- [F2] G. Paschmann Baumjohann, W. and C. A. Cattell. Average plasma properties in the central plasma sheet. *J. Geophys. Res.*, 94, 1989.
- [F3] L. A. Frank et al. Plasma velocity distributions in the near-Earth plasma sheet: A first look with the Geotail spacecraft. *J. Geophys. Res.*, 101:10627–10637, 1996.
- [F4] E. R. Williams. Sprites, Elves, and Glow Discharge Tubes. *Physics to Day*, 52(11), 2001.



# Biology

- [I1] Diffuse interstellar band. [http://en.wikipedia.org/wiki/Diffuse\\_interstellar\\_band](http://en.wikipedia.org/wiki/Diffuse_interstellar_band).
- [I2] Diffuse interstellar bands. [http://en.wikipedia.org/wiki/Diffuse\\_interstellar\\_band](http://en.wikipedia.org/wiki/Diffuse_interstellar_band).
- [I3] From the stars to the thought. <http://www.brunonic.org/Nicolaus/fromthestarstot.htm>.
- [I4] Interstellar Dust as Agent and Subject of Galactic Evolution. [http://www.ricercailiana.it/prin/dettaglio\\_completo\\_prin\\_en-2005022470.htm](http://www.ricercailiana.it/prin/dettaglio_completo_prin_en-2005022470.htm).
- [I5] Magnetic Bees. <http://www.abc.net.au/science/k2/trek/4wd/Over57.htm>.
- [I6] Nanobacterium. <http://en.wikipedia.org/wiki/Nanobacterium>.
- [I7] Nanobe. <http://en.wikipedia.org/wiki/Nanobe>.
- [I8] Photocatalysis. <http://en.wikipedia.org/wiki/Photocatalysis>.
- [I9] Photolysis. <http://en.wikipedia.org/wiki/Photolysis>.
- [I10] Photosynthesis. <http://en.wikipedia.org/wiki/Photosynthesis>.
- [I11] Virus. <http://en.wikipedia.org/wiki/Virus>.
- [I12] *Aids: Biological Warfare*, volume 1649, P. O.Box 1649, Greenville, TX 75401, 1988. Tesla Book Company.
- [I13] Why honeybees never forget a face? *New Scientist*, page 22, December 2005.
- [I14] G. Albrecht-Buehler. Reversible excitation light-induced enhancement of fluorescence of live mammalian mitochondria. *FASEB J.* <http://www.basic.northwestern.edu/g-buehler/relief.htm>, 2000.
- [I15] J. B. Bateman. A Biologically Active Combination of Modulated Magnetic and Microwave Fields: the Priore Machine,. Office of Naval Research. London Report R-5-78. August 1978, 1978.
- [I16] S. Clement. Magnetic Microbes. <http://commtechlab.msu.edu/sites/dlc-me/curious/ca0c96SC.html>, 1996.
- [I17] International Human Sequencing Consortium. Initial sequencing and analysis of the human genome. *Nature*, February 2001.
- [I18] R. E. Cremesti and P. Baterman. Problems with the search for the origin of life. [http://cremesti.com/portfolio/technical\\_writing/Academic\\_Research\\_Papers/Problems\\_With\\_The\\_Search\\_For\\_The\\_Origin\\_of\\_Life.htm](http://cremesti.com/portfolio/technical_writing/Academic_Research_Papers/Problems_With_The_Search_For_The_Origin_of_Life.htm), 1998.
- [I19] B. Tsyтович et al. From Plasma crystals and helical structures towards inorganic living matter. *New Journal of Physics*. <http://www.iop.org/EJ/abstract/1367-2630/9/8/263>, August 2007.
- [I20] E. O. Kajander et al. Comparison of Staphylococci and Novel Bacteria-Like Particles from Blood. *Zbl. Bakt. Suppl.*, 26, 1994.

- [I21] J. P. Dobson et al. Evocation of epileptiform activity by weak DC magnetic fields. *American Geophysical Union Meeting, Baltimore, Maryland. EOS*, (16), 1993.
- [I22] M. Desoil et al. Definitive identification of magnetite nanoparticles in the abdomen of the honeybee *Apis mellifera*. *Journal of Physics: Conference Series*, 17, 2005.
- [I23] P. P. Gariaev et al. The spectroscopy of bio-photons in non-local genetic regulation. *Journal of Non-Locality and Remote Mental Interactions*. <http://www.emergentmind.org/gariaevI3.htm>, (3), 2002.
- [I24] R. L. Folk. Nanno-bacteria; surely not figments but what heaven are they? *Natural science*. <http://naturalSCIENCE.com>, 1, 1997.
- [I25] Celera Genomics. *Science*, 291(5507), February.
- [I26] S. J. Gould. *Wonderful Life*. Penguin Books, 1991.
- [I27] G. T. Javor. *Origins*. <http://origins.swau.edu/papers/life/javor1/default.html>, 14:7–20, 1987.
- [I28] C. King. Biocosmology. <http://www.dhushara.com/book/biocos/biocos.pdf>, 2003.
- [I29] J. L. Kirschvink. Constraints on biological effects of weak extremely-low-frequency electromagnetic fields'. *Phys. Rev. A*. [http://prola.aps.org/abstract/PRA/v46/i4/p2178\\_1](http://prola.aps.org/abstract/PRA/v46/i4/p2178_1), 43(1991), 1992.
- [I30] S.A. Sandford L. J. Allamandola, M. P. Bernstein. *Astronomical and biochemical origins and the search for life in the universe*. Editrice Compositori, Bologna, 1997.
- [I31] E. Levich. *Phys. Rep.*, 3, 1987.
- [I32] E. Lozneau and M. Sanduloviciu. Minimal-cell system created in laboratory by self-organization. *Chaos, Solitons & Fractals*, 18(2):335, September 2003.
- [I33] L. Margulis and M. F. Dolan. *Early Life*. Jones and Bartlett Publ. MA., 2002.
- [I34] G. F. Gahm P. Carlquist and H. Kristen. Theory of twisted trunks. <http://www.aanda.org/articles/aa/abs/2003/20/aa3289/aa3289.html>, 2003.
- [I35] G. Pollack. *Cells, Gels and the Engines of Life*. Ebner and Sons, 2000.
- [I36] R. Saint R. D. Kortschak, G. Samuel and D. J. Miller. EST Analysis of the Cnidarian *Acropora millepora* Reveals Extensive Gene Loss and Rapid Sequence Divergence in the Model Invertebrates. *Current Biology*. <http://www.current-biology.com/content/article/fulltext?uid=PIIS0960982203008728>, pages 2190–2195, 2003.
- [I37] G. Rein. Biological Effects of Quantum Fields and Their Role in the Natural Healing Process. *Frontier Perspectives*, pages 16–23, 1998.
- [I38] S. Silberman. The Bacteria Whisperer. *Wired Magazine*. <http://www.wired.com/wired/archive/11.04/quorum.html>, April 2003.
- [I39] Uma P. Vijn. Extended Red Emission. [http://ardbeg.astro.utoledo.edu/~karen/baglunch/vijh\\_abl\\_spr04.pdf](http://ardbeg.astro.utoledo.edu/~karen/baglunch/vijh_abl_spr04.pdf), 2004.

# Books related to TGD

- [K1] M. Pitkänen. 1983.
- [K2] M. Pitkänen. Is it Possible to Understand Coupling Constant Evolution at Space-Time Level? In *Towards M-Matrix*. Onlinebook. [http://tgdtheory.com/public\\_html/tgdquant/tgdquant.html#rgflow](http://tgdtheory.com/public_html/tgdquant/tgdquant.html#rgflow), 2006.
- [K3] M. Pitkänen. About Strange Effects Related to Rotating Magnetic Systems . In *TGD and Fringe Physics*. Onlinebook. [http://tgdtheory.com/public\\_html/freenergy/freenergy.html#Faraday](http://tgdtheory.com/public_html/freenergy/freenergy.html#Faraday), 2006.
- [K4] M. Pitkänen. About the New Physics Behind Qualia. In *Quantum Hardware of Living Matter*. Onlinebook. [http://tgdtheory.com/public\\_html/bioware/bioware.html#newphys](http://tgdtheory.com/public_html/bioware/bioware.html#newphys), 2006.
- [K5] M. Pitkänen. An Overview about Quantum TGD: Part I. In *Topological Geometrodynamics: Overview*. Onlinebook. [http://tgdtheory.com/public\\_html/tgdview/tgdview.html#evoII](http://tgdtheory.com/public_html/tgdview/tgdview.html#evoII), 2006.
- [K6] M. Pitkänen. An Overview about the Evolution of Quantum TGD. In *Topological Geometrodynamics: Overview*. Onlinebook. [http://tgdtheory.com/public\\_html/tgdview/tgdview.html#evoI](http://tgdtheory.com/public_html/tgdview/tgdview.html#evoI), 2006.
- [K7] M. Pitkänen. Anomalies Related to the Classical  $Z^0$  Force and Gravitation. In *TGD and Fringe Physics*. Onlinebook. [http://tgdtheory.com/public\\_html/freenergy/freenergy.html#Zanom](http://tgdtheory.com/public_html/freenergy/freenergy.html#Zanom), 2006.
- [K8] M. Pitkänen. Appendix A: Quantum Groups and Related Structures. In *Towards M-Matrix*. Onlinebook. [http://tgdtheory.com/public\\_html/tgdquant/tgdquant.html#bialgebra](http://tgdtheory.com/public_html/tgdquant/tgdquant.html#bialgebra), 2006.
- [K9] M. Pitkänen. Basic Extremals of Kähler Action. In *Physics in Many-Sheeted Space-Time*. Onlinebook. [http://tgdtheory.com/public\\_html/tgdclass/tgdclass.html#class](http://tgdtheory.com/public_html/tgdclass/tgdclass.html#class), 2006.
- [K10] M. Pitkänen. *Bio-Systems as Conscious Holograms*. Onlinebook. [http://tgdtheory.com/public\\_html/hologram/hologram.html](http://tgdtheory.com/public_html/hologram/hologram.html), 2006.
- [K11] M. Pitkänen. Bio-Systems as Conscious Holograms. In *Bio-Systems as Conscious Holograms*. Onlinebook. [http://tgdtheory.com/public\\_html/hologram/hologram.html#hologram](http://tgdtheory.com/public_html/hologram/hologram.html#hologram), 2006.
- [K12] M. Pitkänen. *Bio-Systems as Self-Organizing Quantum Systems*. Onlinebook. [http://tgdtheory.com/public\\_html/bioselforg/bioselforg.html](http://tgdtheory.com/public_html/bioselforg/bioselforg.html), 2006.
- [K13] M. Pitkänen. Bio-Systems as Super-Conductors: part I. In *Quantum Hardware of Living Matter*. Onlinebook. [http://tgdtheory.com/public\\_html/bioware/bioware.html#superc1](http://tgdtheory.com/public_html/bioware/bioware.html#superc1), 2006.
- [K14] M. Pitkänen. Bio-Systems as Super-Conductors: part II. In *Quantum Hardware of Living Matter*. Onlinebook. [http://tgdtheory.com/public\\_html/bioware/bioware.html#superc2](http://tgdtheory.com/public_html/bioware/bioware.html#superc2), 2006.
- [K15] M. Pitkänen. Configuration Space Spinor Structure. In *Quantum Physics as Infinite-Dimensional Geometry*. Onlinebook. [http://tgdtheory.com/public\\_html/tgdgeom/tgdgeom.html#cspin](http://tgdtheory.com/public_html/tgdgeom/tgdgeom.html#cspin), 2006.

- [K16] M. Pitkänen. Construction of elementary particle vacuum functionals. In *p-Adic Length Scale Hypothesis and Dark Matter Hierarchy*. Onlinebook. [http://tgdtheory.com/public\\_html/paddark/paddark.html#elvafu](http://tgdtheory.com/public_html/paddark/paddark.html#elvafu), 2006.
- [K17] M. Pitkänen. Construction of Quantum Theory: M-matrix. In *Towards M-Matrix*. Onlinebook. [http://tgdtheory.com/public\\_html/tgdquant/tgdquant.html#towards](http://tgdtheory.com/public_html/tgdquant/tgdquant.html#towards), 2006.
- [K18] M. Pitkänen. Cosmic Strings. In *Physics in Many-Sheeted Space-Time*. Onlinebook. [http://tgdtheory.com/public\\_html/tgdclass/tgdclass.html#cstrings](http://tgdtheory.com/public_html/tgdclass/tgdclass.html#cstrings), 2006.
- [K19] M. Pitkänen. Crop Circles and Life at Parallel Space-Time Sheets. In *Magnetospheric Consciousness*. Onlinebook. [http://tgdtheory.com/public\\_html/magnconsc/magnconsc.html#crop1](http://tgdtheory.com/public_html/magnconsc/magnconsc.html#crop1), 2006.
- [K20] M. Pitkänen. Crop Circles and Life at Parallel Space-Time Sheets. In *Magnetospheric Consciousness*. Onlinebook. [http://tgdtheory.com/public\\_html/magnconsc/magnconsc.html#crop2](http://tgdtheory.com/public_html/magnconsc/magnconsc.html#crop2), 2006.
- [K21] M. Pitkänen. Dark Forces and Living Matter. In *p-Adic Length Scale Hypothesis and Dark Matter Hierarchy*. Onlinebook. [http://tgdtheory.com/public\\_html/paddark/paddark.html#darkforces](http://tgdtheory.com/public_html/paddark/paddark.html#darkforces), 2006.
- [K22] M. Pitkänen. Dark Matter Hierarchy and Hierarchy of EEGs. In *TGD and EEG*. Onlinebook. [http://tgdtheory.com/public\\_html/tgdeeg/tgdeeg.html#eegdark](http://tgdtheory.com/public_html/tgdeeg/tgdeeg.html#eegdark), 2006.
- [K23] M. Pitkänen. Dark Nuclear Physics and Condensed Matter. In *p-Adic Length Scale Hypothesis and Dark Matter Hierarchy*. Onlinebook. [http://tgdtheory.com/public\\_html/paddark/paddark.html#exonuclear](http://tgdtheory.com/public_html/paddark/paddark.html#exonuclear), 2006.
- [K24] M. Pitkänen. DNA as Topological Quantum Computer. In *Genes and Memes*. Onlinebook. [http://tgdtheory.com/public\\_html/genememe/genememe.html#dnatqc](http://tgdtheory.com/public_html/genememe/genememe.html#dnatqc), 2006.
- [K25] M. Pitkänen. Does TGD Predict the Spectrum of Planck Constants? In *Towards M-Matrix*. Onlinebook. [http://tgdtheory.com/public\\_html/tgdquant/tgdquant.html#Planck](http://tgdtheory.com/public_html/tgdquant/tgdquant.html#Planck), 2006.
- [K26] M. Pitkänen. Evolution in Many-Sheeted Space-Time. In *Genes and Memes*. Onlinebook. [http://tgdtheory.com/public\\_html/genememe/genememe.html#prebio](http://tgdtheory.com/public_html/genememe/genememe.html#prebio), 2006.
- [K27] M. Pitkänen. General Ideas about Many-Sheeted Space-Time: Part I. In *Physics in Many-Sheeted Space-Time*. Onlinebook. [http://tgdtheory.com/public\\_html/tgdclass/tgdclass.html#topcond](http://tgdtheory.com/public_html/tgdclass/tgdclass.html#topcond), 2006.
- [K28] M. Pitkänen. General Theory of Qualia. In *Bio-Systems as Conscious Holograms*. Onlinebook. [http://tgdtheory.com/public\\_html/hologram/hologram.html#qualia](http://tgdtheory.com/public_html/hologram/hologram.html#qualia), 2006.
- [K29] M. Pitkänen. *Genes and Memes*. Onlinebook. [http://tgdtheory.com/public\\_html/genememe/genememe.html](http://tgdtheory.com/public_html/genememe/genememe.html), 2006.
- [K30] M. Pitkänen. Genes and Memes. In *Genes and Memes*. Onlinebook. [http://tgdtheory.com/public\\_html/genememe/genememe.html#genememec](http://tgdtheory.com/public_html/genememe/genememe.html#genememec), 2006.
- [K31] M. Pitkänen. Homeopathy in Many-Sheeted Space-Time. In *Bio-Systems as Conscious Holograms*. Onlinebook. [http://tgdtheory.com/public\\_html/hologram/hologram.html#homeoc](http://tgdtheory.com/public_html/hologram/hologram.html#homeoc), 2006.
- [K32] M. Pitkänen. Macro-Temporal Quantum Coherence and Spin Glass Degeneracy. In *Bio-Systems as Conscious Holograms*. Onlinebook. [http://tgdtheory.com/public\\_html/hologram/hologram.html#macro](http://tgdtheory.com/public_html/hologram/hologram.html#macro), 2006.
- [K33] M. Pitkänen. Macroscopic Quantum Coherence and Quantum Metabolism as Different Sides of the Same Coin. In *Bio-Systems as Conscious Holograms*. Onlinebook. [http://tgdtheory.com/public\\_html/hologram/hologram.html#metab](http://tgdtheory.com/public_html/hologram/hologram.html#metab), 2006.

- [K34] M. Pitkänen. Macroscopic Quantum Phenomena and  $CP_2$  Geometry. In *Physics in Many-Sheeted Space-Time*. Onlinebook. [http://tgdtheory.com/public\\_html/tgdclass/tgdclass.html#super](http://tgdtheory.com/public_html/tgdclass/tgdclass.html#super), 2006.
- [K35] M. Pitkänen. Magnetic Sensory Canvas Hypothesis. In *TGD and EEG*. Onlinebook. [http://tgdtheory.com/public\\_html//tgdeeg/tgdeeg/tgdeeg.html#mec](http://tgdtheory.com/public_html//tgdeeg/tgdeeg/tgdeeg.html#mec), 2006.
- [K36] M. Pitkänen. *Magnetospheric Consciousness*. Onlinebook. [http://tgdtheory.com/public\\_html/magnconsc/magnconsc.html](http://tgdtheory.com/public_html/magnconsc/magnconsc.html), 2006.
- [K37] M. Pitkänen. Magnetospheric Sensory Representations. In *Magnetospheric Consciousness*. Onlinebook. [http://tgdtheory.com/public\\_html/magnconsc/magnconsc.html#srepres](http://tgdtheory.com/public_html/magnconsc/magnconsc.html#srepres), 2006.
- [K38] M. Pitkänen. Many-Sheeted DNA. In *Genes and Memes*. Onlinebook. [http://tgdtheory.com/public\\_html/genememe/genememe.html#genecodec](http://tgdtheory.com/public_html/genememe/genememe.html#genecodec), 2006.
- [K39] M. Pitkänen. Massless states and particle massivation. In *p-Adic Length Scale Hypothesis and Dark Matter Hierarchy*. Onlinebook. [http://tgdtheory.com/public\\_html/paddark/paddark.html#mless](http://tgdtheory.com/public_html/paddark/paddark.html#mless), 2006.
- [K40] M. Pitkänen. *Mathematical Aspects of Consciousness Theory*. Onlinebook. [http://tgdtheory.com/public\\_html/mathconsc/mathconsc.html](http://tgdtheory.com/public_html/mathconsc/mathconsc.html), 2006.
- [K41] M. Pitkänen. Matter, Mind, Quantum. In *TGD Inspired Theory of Consciousness*. Onlinebook. [http://tgdtheory.com/public\\_html/tgdconsc/tgdconsc.html#conscic](http://tgdtheory.com/public_html/tgdconsc/tgdconsc.html#conscic), 2006.
- [K42] M. Pitkänen. Negentropy Maximization Principle. In *TGD Inspired Theory of Consciousness*. Onlinebook. [http://tgdtheory.com/public\\_html/tgdconsc/tgdconsc.html#nmpc](http://tgdtheory.com/public_html/tgdconsc/tgdconsc.html#nmpc), 2006.
- [K43] M. Pitkänen. New Particle Physics Predicted by TGD: Part I. In *p-Adic Length Scale Hypothesis and Dark Matter Hierarchy*. Onlinebook. [http://tgdtheory.com/public\\_html/paddark/paddark.html#mass4](http://tgdtheory.com/public_html/paddark/paddark.html#mass4), 2006.
- [K44] M. Pitkänen. Nuclear String Hypothesis. In *p-Adic Length Scale Hypothesis and Dark Matter Hierarchy*. Onlinebook. [http://tgdtheory.com/public\\_html/paddark/paddark.html#nuclstring](http://tgdtheory.com/public_html/paddark/paddark.html#nuclstring), 2006.
- [K45] M. Pitkänen. *p-Adic length Scale Hypothesis and Dark Matter Hierarchy*. Onlinebook. [http://tgdtheory.com/public\\_html/paddark/paddark.html](http://tgdtheory.com/public_html/paddark/paddark.html), 2006.
- [K46] M. Pitkänen. p-Adic Particle Massivation: Hadron Masses. In *p-Adic Length Scale Hypothesis and Dark Matter Hierarchy*. Onlinebook. [http://tgdtheory.com/public\\_html/paddark/paddark.html#mass3](http://tgdtheory.com/public_html/paddark/paddark.html#mass3), 2006.
- [K47] M. Pitkänen. p-Adic Physics as Physics of Cognition and Intention. In *TGD Inspired Theory of Consciousness*. Onlinebook. [http://tgdtheory.com/public\\_html/tgdconsc/tgdconsc.html#cognic](http://tgdtheory.com/public_html/tgdconsc/tgdconsc.html#cognic), 2006.
- [K48] M. Pitkänen. *Physics in Many-Sheeted Space-Time*. Onlinebook. [http://tgdtheory.com/public\\_html/tgdclass/tgdclass.html](http://tgdtheory.com/public_html/tgdclass/tgdclass.html), 2006.
- [K49] M. Pitkänen. Quantum Antenna Hypothesis. In *Quantum Hardware of Living Matter*. Onlinebook. [http://tgdtheory.com/public\\_html/bioware/bioware.html#tubuc](http://tgdtheory.com/public_html/bioware/bioware.html#tubuc), 2006.
- [K50] M. Pitkänen. Quantum Astrophysics. In *Physics in Many-Sheeted Space-Time*. Onlinebook. [http://tgdtheory.com/public\\_html/tgdclass/tgdclass.html#qastro](http://tgdtheory.com/public_html/tgdclass/tgdclass.html#qastro), 2006.
- [K51] M. Pitkänen. Quantum Control and Coordination in Bio-systems: Part I. In *Bio-Systems as Self-Organizing Quantum Systems*. Onlinebook. [http://tgdtheory.com/public\\_html/bioselforg/bioselforg.html#qcococI](http://tgdtheory.com/public_html/bioselforg/bioselforg.html#qcococI), 2006.
- [K52] M. Pitkänen. Quantum Control and Coordination in Bio-Systems: Part II. In *Bio-Systems as Self-Organizing Quantum Systems*. Onlinebook. [http://tgdtheory.com/public\\_html/bioselforg/bioselforg.html#qcococII](http://tgdtheory.com/public_html/bioselforg/bioselforg.html#qcococII), 2006.

- [K53] M. Pitkänen. *Quantum Hardware of Living Matter*. Onlinebook. [http://tgdtheory.com/public\\_html/bioware/bioware.html](http://tgdtheory.com/public_html/bioware/bioware.html), 2006.
- [K54] M. Pitkänen. Quantum Model for Hearing. In *TGD and EEG*. Onlinebook. [http://tgdtheory.com/public\\_html//tgdeeg/tgdeeg/tgdeeg.html#hearing](http://tgdtheory.com/public_html//tgdeeg/tgdeeg/tgdeeg.html#hearing), 2006.
- [K55] M. Pitkänen. Quantum Model for Nerve Pulse. In *TGD and EEG*. Onlinebook. [http://tgdtheory.com/public\\_html//tgdeeg/tgdeeg/tgdeeg.html#pulse](http://tgdtheory.com/public_html//tgdeeg/tgdeeg/tgdeeg.html#pulse), 2006.
- [K56] M. Pitkänen. Quantum Model for Paranormal Phenomena. In *TGD Inspired Theory of Consciousness*. Onlinebook. [http://tgdtheory.com/public\\_html/tgdconsc/tgdconsc.html#parac](http://tgdtheory.com/public_html/tgdconsc/tgdconsc.html#parac), 2006.
- [K57] M. Pitkänen. Quantum Model for Sensory Representations. In *TGD Inspired Theory of Consciousness*. Onlinebook. [http://tgdtheory.com/public\\_html/tgdconsc/tgdconsc.html#expc](http://tgdtheory.com/public_html/tgdconsc/tgdconsc.html#expc), 2006.
- [K58] M. Pitkänen. Quantum Model of EEG. In *TGD and EEG*. Onlinebook. [http://tgdtheory.com/public\\_html/tgdeeg/tgdeeg.html#eegII](http://tgdtheory.com/public_html/tgdeeg/tgdeeg.html#eegII), 2006.
- [K59] M. Pitkänen. Quantum Model of Memory. In *TGD Inspired Theory of Consciousness*. Onlinebook. [http://tgdtheory.com/public\\_html/tgdconsc/tgdconsc.html#memoryc](http://tgdtheory.com/public_html/tgdconsc/tgdconsc.html#memoryc), 2006.
- [K60] M. Pitkänen. *Quantum Physics as Infinite-Dimensional Geometry*. Onlinebook. [http://tgdtheory.com/public\\_html/tgdgeom/tgdgeom.html](http://tgdtheory.com/public_html/tgdgeom/tgdgeom.html), 2006.
- [K61] M. Pitkänen. *Quantum TGD*. Onlinebook. [http://tgdtheory.com/public\\_html/tgdquant/tgdquant.html](http://tgdtheory.com/public_html/tgdquant/tgdquant.html), 2006.
- [K62] M. Pitkänen. Quantum Theory of Self-Organization. In *Bio-Systems as Self-Organizing Quantum Systems*. Onlinebook. [http://tgdtheory.com/public\\_html/bioselforg/bioselforg.html#selforgac](http://tgdtheory.com/public_html/bioselforg/bioselforg.html#selforgac), 2006.
- [K63] M. Pitkänen. Semi-trance, Mental Illness, and Altered States of Consciousness. In *Magnetospheric Consciousness*. Onlinebook. [http://tgdtheory.com/public\\_html/magnconsc/magnconsc.html#semitrancec](http://tgdtheory.com/public_html/magnconsc/magnconsc.html#semitrancec), 2006.
- [K64] M. Pitkänen. Semitrance, Language, and Development of Civilization. In *Magnetospheric Consciousness*. Onlinebook. [http://tgdtheory.com/public\\_html/magnconsc/magnconsc.html#langsoc](http://tgdtheory.com/public_html/magnconsc/magnconsc.html#langsoc), 2006.
- [K65] M. Pitkänen. TGD and Astrophysics. In *Physics in Many-Sheeted Space-Time*. Onlinebook. [http://tgdtheory.com/public\\_html/tgdclass/tgdclass.html#astro](http://tgdtheory.com/public_html/tgdclass/tgdclass.html#astro), 2006.
- [K66] M. Pitkänen. TGD and Cosmology. In *Physics in Many-Sheeted Space-Time*. Onlinebook. [http://tgdtheory.com/public\\_html/tgdclass/tgdclass.html#cosmo](http://tgdtheory.com/public_html/tgdclass/tgdclass.html#cosmo), 2006.
- [K67] M. Pitkänen. *TGD and EEG*. Onlinebook. [http://tgdtheory.com/public\\_html/tgdeeg/tgdeeg.html](http://tgdtheory.com/public_html/tgdeeg/tgdeeg.html), 2006.
- [K68] M. Pitkänen. *TGD and Fringe Physics*. Onlinebook. [http://tgdtheory.com/public\\_html/freenergy/freenergy.html](http://tgdtheory.com/public_html/freenergy/freenergy.html), 2006.
- [K69] M. Pitkänen. TGD and Nuclear Physics. In *p-Adic Length Scale Hypothesis and Dark Matter Hierarchy*. Onlinebook. [http://tgdtheory.com/public\\_html/paddark/paddark.html#padnucl](http://tgdtheory.com/public_html/paddark/paddark.html#padnucl), 2006.
- [K70] M. Pitkänen. *TGD as a Generalized Number Theory*. Onlinebook. [http://tgdtheory.com/public\\_html/tgdnumber/tgdnumber.html](http://tgdtheory.com/public_html/tgdnumber/tgdnumber.html), 2006.
- [K71] M. Pitkänen. TGD as a Generalized Number Theory: p-Adicization Program. In *TGD as a Generalized Number Theory*. Onlinebook. [http://tgdtheory.com/public\\_html/tgdnumber/tgdnumber.html#visiona](http://tgdtheory.com/public_html/tgdnumber/tgdnumber.html#visiona), 2006.



- [K72] M. Pitkänen. TGD as a Generalized Number Theory: Quaternions, Octonions, and their Hyper Counterparts. In *TGD as a Generalized Number Theory*. Onlinebook. [http://tgdtheory.com/public\\_html/tgdnumber/tgdnumber.html#visionb](http://tgdtheory.com/public_html/tgdnumber/tgdnumber.html#visionb), 2006.
- [K73] M. Pitkänen. TGD Based Model for OBEs. In *TGD Inspired Theory of Consciousness*. Onlinebook. [http://tgdtheory.com/public\\_html/tgdconsc/tgdconsc.html#OBE](http://tgdtheory.com/public_html/tgdconsc/tgdconsc.html#OBE), 2006.
- [K74] M. Pitkänen. *TGD Inspired Theory of Consciousness*. Onlinebook. [http://tgdtheory.com/public\\_html/tgdconsc/tgdconsc.html](http://tgdtheory.com/public_html/tgdconsc/tgdconsc.html), 2006.
- [K75] M. Pitkänen. TGD Inspired Theory of Consciousness. In *Topological Geometrodynamics: Overview*. Onlinebook. [http://tgdtheory.com/public\\_html/tgdview/tgdview.html#tgdconsc2010](http://tgdtheory.com/public_html/tgdview/tgdview.html#tgdconsc2010), 2006.
- [K76] M. Pitkänen. The Notion of Free Energy and Many-Sheeted Space-Time Concept. In *TGD and Fringe Physics*. Onlinebook. [http://tgdtheory.com/public\\_html/freenergy/freenergy.html#freenergy](http://tgdtheory.com/public_html/freenergy/freenergy.html#freenergy), 2006.
- [K77] M. Pitkänen. The Relationship Between TGD and GRT. In *Physics in Many-Sheeted Space-Time*. Onlinebook. [http://tgdtheory.com/public\\_html/tgdclass/tgdclass.html#tgdgrt](http://tgdtheory.com/public_html/tgdclass/tgdclass.html#tgdgrt), 2006.
- [K78] M. Pitkänen. Three new physics realizations of the genetic code and the role of dark matter in bio-systems. In *Genes and Memes*. Onlinebook. [http://tgdtheory.com/public\\_html/genememe/genememe.html#dnatqccodes](http://tgdtheory.com/public_html/genememe/genememe.html#dnatqccodes), 2006.
- [K79] M. Pitkänen. Time, Spacetime and Consciousness. In *Bio-Systems as Conscious Holograms*. Onlinebook. [http://tgdtheory.com/public\\_html/hologram/hologram.html#time](http://tgdtheory.com/public_html/hologram/hologram.html#time), 2006.
- [K80] M. Pitkänen. *Topological Geometrodynamics: an Overview*. Onlinebook. [http://tgdtheory.com/public\\_html/tgdview/tgdview.html](http://tgdtheory.com/public_html/tgdview/tgdview.html), 2006.
- [K81] M. Pitkänen. Topological Quantum Computation in TGD Universe. In *Genes and Memes*. Onlinebook. [http://tgdtheory.com/public\\_html/genememe/genememe.html#tqc](http://tgdtheory.com/public_html/genememe/genememe.html#tqc), 2006.
- [K82] M. Pitkänen. Was von Neumann Right After All. In *Towards M-Matrix*. Onlinebook. [http://tgdtheory.com/public\\_html/tgdquant/tgdquant.html#vNeumann](http://tgdtheory.com/public_html/tgdquant/tgdquant.html#vNeumann), 2006.
- [K83] M. Pitkänen. Wormhole Magnetic Fields. In *Quantum Hardware of Living Matter*. Onlinebook. [http://tgdtheory.com/public\\_html/bioware/bioware.html#wormc](http://tgdtheory.com/public_html/bioware/bioware.html#wormc), 2006.



# Articles about TGD

- [L1] M. Pitkänen. Macro-temporal quantum coherence, quantum spin glass degeneracy, and number theoretic information concept. <http://www.emergentmind.org/journal.htm>, 2003.
- [L2] M. Pitkänen. Time, Space-Time, and Consciousness. <http://www.emergentmind.org/journal.htm>, 2003.
- [L3] M. Pitkänen. Further Progress in Nuclear String Hypothesis. <http://tgdtheory.com/articles/nuclstring.pdf>, 2007.
- [L4] M. Pitkänen. TGD based solution of Fermi paradox. <http://www.physics.helsinki.fi/~matpitka/articles/fermieng.pdf>, 2007.



## Chapter 15

# Mathematical Speculations about the Hierarchy of Planck Constants

### 15.1 Introduction

I decided to separate the purely mathematical speculations about the hierarchy of Planck constants (actually only effective hierarchy if the recent interpretation is correct) from the material describing the physical ideas, key mathematical concepts, and the basic applications. These mathematical speculations emerged during the first stormy years in the evolution of the ideas about Planck constant and must be taken with a big grain of salt. I feel myself rather conservative as compared to the fellow who produced this stuff for 7 years ago. This all is of course very relative. Many readers might experience this recent me as a reckless speculator.

The first highly speculative topic discussed in this chapter is about possible connection of the hierarchy of Planck constants with Jones inclusions.

1. The connection with Jones inclusions was originally a purely heuristic guess based on the observation that the finite groups characterizing Jones inclusion characterize also pages of the Big Book. The key observation is that Jones inclusions are characterized by a finite subgroup  $G \subset SU(2)$  and that this group also characterizes the singular covering or factor spaces associated with  $CD$  or  $CP_2$  so that the pages of generalized imbedding space could indeed serve as correlates for Jones inclusions. The elements of the included algebra  $\mathcal{M}$  are invariant under the action of  $G$  and  $\mathcal{M}$  takes the role of complex numbers in the resulting non-commutative quantum theory.
2. The understanding of quantum TGD at parton level led to the realization that the dynamics of Kähler action realizes finite measurement resolution in terms of finite number of modes of the induced spinor field. This automatically implies cutoffs to the representations of various super-conformal algebras typical for the representations of quantum groups closely associated with Jones inclusions [K8]. The Clifford algebra spanned by the fermionic oscillator operators would provide a realization for the factor space  $\mathcal{N}/\mathcal{M}$  of hyper-finite factors of type  $II_1$  identified as the infinite-dimensional Clifford algebra  $\mathcal{N}$  of the configuration space and included algebra  $\mathcal{M}$  determining the finite measurement resolution. The resulting quantum Clifford algebra has anti-commutation relations dictated by the fractionization of fermion number so that its unit becomes  $r = \hbar/\hbar_0$ .  $SU(2)$  Lie algebra transforms to its quantum variant corresponding to the quantum phase  $q = exp(i2\pi/r)$ .
3. Jones inclusions appear as two variants corresponding to  $\mathcal{N} : \mathcal{M} < 4$  and  $\mathcal{N} : \mathcal{M} = 4$ . The tentative interpretation is in terms of singular  $G$ -factor spaces and  $G$ -coverings of  $M^4$  or  $CP_2$  in some sense. The alternative interpretation in terms of two geodesic spheres of  $CP_2$  would mean asymmetry between  $M^4$  and  $CP_2$  degrees of freedom.
4. Number theoretic Universality suggests an answer why the hierarchy of Planck constants is necessary. One must be able to define the notion of angle -or at least the notion of phase and of trigonometric functions- also in p-adic context. All that one can achieve naturally is the

notion of phase defined as root of unity and introduced by allowing algebraic extension of p-adic number field by introducing the phase if needed. In the framework of TGD inspired theory of consciousness this inspires a vision about cognitive evolution as the gradual emergence of increasingly complex algebraic extensions of p-adic numbers and involving also the emergence of improved angle resolution expressible in terms of phases  $\exp(i2\pi/n)$  up to some maximum value of  $n$ . The coverings and factor spaces would realize these phases geometrically and quantum phases  $q$  naturally assignable to Jones inclusions would realize them algebraically. Besides p-adic coupling constant evolution based on hierarchy of p-adic length scales there would be coupling constant evolution with respect to  $\hbar$  and associated with angular resolution.

There are also speculations relating to the hierarchy of Planck constants, Mc-Kay correspondence, and Jones inclusions. Even Farey sequences, Riemann hypothesis and N-tangles are discussed. Depending on reader these speculations might be experienced as irritating or entertaining. It would be interesting to go this stuff through in the light of recent understanding of the effective hierarchy of Planck constants to see what portion of it survives.

## 15.2 Jones inclusions and generalization of the imbedding space

The original motivation for the generalization of the imbedding space was the idea that the pages of the Big Book would provide correlates for Jones inclusions. In the following an attempt to formulate this vision more precisely is carried out.

### 15.2.1 Basic facts about Jones inclusions

Here only basic facts about Jones inclusions are discussed. Appendix contains a more detailed discussion of inclusions of HFFs.

#### Jones inclusions defined by subgroups of $SL(2, C) \times SU(2)$

Jones inclusions with  $\mathcal{M} : \mathcal{N} < 4$  have representation as  $R_0^G \subset R^G$  with  $G$  a discrete subgroup of  $SU(2)$ .  $SO(3)$  or  $SU(2)$  can be interpreted as acting in  $CP_2$  as rotations. On quantum spinors the action corresponds to double cover of  $G$ .

A more general choice for  $G$  would be as a discrete subgroup  $G_a \times G_b \subset SL(2, C) \times SU(2) \times SU(2)$ . Poincare invariance suggests that the subgroup of  $SL(2, C)$  reduces either to a discrete subgroup of  $SU(2)$  and in the case that the rotations are genuinely 3-dimensional ( $E^6, E^8$ ), the only possible interpretation would be as isotropy group of a particle at rest. When the group acts on plane as in case of  $A_n$  and  $D_{2n}$ , it could be also assigned to a massless particle.

If the group involves boosts it contains an infinite number of elements and it is not clear whether this kind of situation is physically sensible. In this case Jones inclusion could be interpreted as an inclusion for the tensor product of  $G$  invariant algebras associated with  $CD$  and  $CP_2$  degrees of freedom and one would have  $\mathcal{M} : \mathcal{N} = \mathcal{M} : \mathcal{N}(G_a) \times \mathcal{M} : \mathcal{N}(G_b)$ . Since the index increases as the order of  $G$  increases one has reasons to expect that in the case of  $G_a = SL(2, C)$   $N_a = \infty$  implies larger  $\mathcal{M} : \mathcal{N}(G_a) > 4$ .

A possible interpretation is that the values  $\mathcal{M} : \mathcal{N} \leq 4$  are analogous to bound state energies so that a discrete rotation group acting in the relative rotational degrees of freedom can act as a symmetry group whereas the values  $\mathcal{M} : \mathcal{N} > 4$  are analogous to ionized states for which particles are almost freely moving with respect to each other with a constant velocity.

When one restricts the coefficients to  $G$ -invariant elements of Clifford algebra the Clifford field is  $G$ -invariant under the natural action of  $G$ . This allows two interpretations. Either the Clifford field is  $G$  invariant or that the Clifford field is defined in orbifold  $CD/G_a \times CP_2/G_b$ .  $CD/G_a$  is obtained by replacing hyperboloid  $H_a$  ( $t^2 - x^2 - y^2 - z^2 = a^2$ ) with  $H_a/G_a$ . These spaces have been considered as cosmological models having 3-space with finite volume [K66] (also a lattice like structure could be in question).

#### The quantum phases associated with sub-groups of $SU(2)$

It is natural to identify quantum phase as that defined by the maximal cyclic subgroup for finite subgroups of  $SU(2)$  and infinite subgroups of  $SL(2, C)$ . Before continuing a brief summary about

quantum phases associated with finite subgroups of  $SU(2)$  is in order.  $E_6$  corresponds to  $N = 24$  and  $n = 3$  and  $E_8$  to icosahedron with  $N = 120$ ,  $n = 5$  and Golden mean and the minimal value of  $n$  making possible universal topological quantum computer [K81].

$D_n$  and  $A_n$  have orders  $2n$  and  $n+1$  and act as symmetry groups of  $n$ -polygon and have  $n$ -element cyclic group as a maximal cyclic subgroup. For double covers the orders are twice this. Thus  $A_n$  resp.  $D_{2n}$  correspond to  $q = \exp(i\pi/n)$  resp.  $q = \exp(i\pi/2n)$ . Note that the restriction  $n \geq 3$  means geometrically that only non-trivial polygons are allowed.

### 15.2.2 Jones inclusions and the hierarchy of Planck constants

The anyonic arguments for the quantization of Planck constant suggest that one can assign separate scalings of Planck constant to  $CD$  and  $CP_2$  degrees of freedom and that these scalings in turn reflect as scalings of  $M^4 \pm$  and  $CP_2$  metrics. This is definitely not in accordance with the original TGD vision based on uniqueness of imbedding space but makes sense if space-time and imbedding space are emergent concepts as the hierarchy of number theoretical von Neumann algebra inclusions indeed suggests. Indeed, the scaling factors of  $CD$  and  $CP_2$  metric remain non-fixed by the general uniqueness arguments since Cartesian product is in question.

#### Hierarchy of Planck constants and choice of quantization axis

Jones inclusions seem to relate in a natural manner to the selection of quantization axis.

1. In the case of  $CD$  the orbifold singularity is for all groups  $G_a$  except  $E_6$  and  $E_8$  the time-like plane  $M^2$  corresponding to a radial ray through origin defining the quantization axis of angular momentum and intersecting light-cone boundary along a preferred light-like ray. For  $E_6$  and  $E_8$  (tetrahedral and icosahedral symmetries) the singularity consists of planes  $M^2$  related by symmetries of  $G$  sharing time-like line  $M^1$  and in this case there are several alternative identifications of the quantization axes as axis around which the maximal cyclic subgroup acts as rotations.
2. From this it should be obvious that Jones inclusions represented in this manner would relate very closely to the selection of quantization axes and provide a geometric representation for this selection at the level of space-time and configuration space. The existence of the preferred direction of quantization at a given level of dark matter level should have observable consequences. For instance, in cosmology this could mean a breaking of perfect rotational symmetry at dark matter space-time sheets. The interpretation would be as a quantum effect in cosmological length scales. An interesting question is whether the observed asymmetry of cosmic microwave background could have interpretation as a quantum effect in cosmological length and time scales.

#### Do factor spaces and coverings correspond to the two kinds of Jones inclusions?

What could be the interpretation of the singular coverings and factor spaces? If both geodesic spheres of  $CP_2$  are allowed  $\mathcal{M} : \mathcal{N} = 4$  could correspond to the allowance of cosmic strings and other analogous objects. This option is however asymmetric with respect to  $CD$  and  $CP_2$  and the more plausible option is that the two kinds of Jones inclusions correspond to singular factor spaces and coverings.

1. Jones inclusions appear in two varieties corresponding to  $\mathcal{M} : \mathcal{N} < 4$  and  $\mathcal{M} : \mathcal{N} = 4$  and one can assign a hierarchy of subgroups of  $SU(2)$  with both of them. In particular, their maximal Abelian subgroups  $Z_n$  label these inclusions. The interpretation of  $Z_n$  as invariance group is natural for  $\mathcal{M} : \mathcal{N} < 4$  and it naturally corresponds to the coset spaces. For  $\mathcal{M} : \mathcal{N} = 4$  the interpretation of  $Z_n$  has remained open. Obviously the interpretation of  $Z_n$  as the homology group defining covering would be natural.
2. For covering spaces one would however obtain the degrees of freedom associated with the discrete fiber and the degrees of freedom in question would not disappear completely and would be characterized by the discrete subgroup of  $SU(2)$ . For anyons the non-trivial homotopy of plane brings in non-trivial connection with a flat curvature and the non-trivial dynamics of topological QFTs. Also now one might expect similar non-trivial contribution to appear in the spinor

connection of  $\hat{C}D \hat{\times} G_a$  and  $\hat{C}P_2 \hat{\times} G_b$ . In conformal field theory models non-trivial monodromy would correspond to the presence of punctures in plane. This picture is also consistent with the  $G$  singlets of the quantum states despite the fact that fermionic oscillator operators belong to non-trivial irreps of  $G$ .

### Coverings and factors spaces form an algebra like structure

It is easy to see that coverings and factor spaces defining the pages of the Big Book form an algebra like structure.

1. For factor spaces the unit for quantum numbers like orbital angular momentum is multiplied by  $n_a$  resp.  $n_b$  and for coverings it is divided by this number. These two kind of spaces are in a well defined sense obtained by multiplying and dividing the factors of  $\hat{H}$  by  $G_a$  resp.  $G_b$  and multiplication and division are expected to relate to Jones inclusions with  $\mathcal{M} : \mathcal{N} < 4$  and  $\mathcal{M} : \mathcal{N} = 4$ , which both are labeled by a subset of discrete subgroups of  $SU(2)$ .
2. The discrete subgroups of  $SU(2)$  with fixed quantization axis possess a well defined multiplication with product defined as the group generated by forming all possible products of group elements as elements of  $SU(2)$ . This product is commutative and all elements are idempotent and thus analogous to projectors. Trivial group  $G_1$ , two-element group  $G_2$  consisting of reflection and identity, the cyclic groups  $Z_p$ ,  $p$  prime, and tetrahedral, octahedral, and icosahedral groups are the generators of this algebra.

By commutativity one can regard this algebra as an 11-dimensional module having natural numbers as coefficients ("rig"). The trivial group  $G_1$ , two-element group  $G_2$  generated by reflection, and tetrahedral, octahedral, and icosahedral groups define 5 generating elements for this algebra. The products of groups other than trivial group define 10 units for this algebra so that there are 11 units altogether. The groups  $Z_p$  generate a structure analogous to natural numbers acting as analog of coefficients of this structure. Clearly, one has effectively 11-dimensional commutative algebra in 1-1 correspondence with the 11-dimensional "half-lattice"  $N^{11}$  ( $N$  denotes natural numbers). Leaving away reflections, one obtains  $N^7$ . The projector representation suggests a connection with Jones inclusions. An interesting question concerns the possible Jones inclusions assignable to the subgroups containing infinitely manner elements. Reader has of course already asked whether dimensions 11, 7 and their difference 4 might relate somehow to the mathematical structures of M-theory with 7 compactified dimensions. One could introduce generalized configuration space spinor fields in the configuration space labeled by sectors of  $H$  with given quantization axes. By introducing Fourier transform in  $N^{11}$  one would formally obtain an infinite-component field in 11-D space.

### Connection between Jones inclusions, hierarchy of Planck constants, and finite number of spinor modes

The original generalization of the imbedding space to accommodate the hierarchy of Planck constants was based on the idea that the singular coverings and factor spaces associated with the causal diamond  $CD$  and  $CP_2$ , which appears as factors of  $CD \times CP_2$  correspond somehow to Jones inclusions, and that the integers  $n_a$  and  $n_b$  characterizing the orders of maximal cyclic groups of groups  $G_a$  and  $G_b$  associated with the two Cartesian factors correspond to quantum phases  $q = \exp(i2\pi/n_i)$  in such a manner that singular factor spaces correspond to Jones inclusions with index  $\mathcal{M} : \mathcal{N} < 4$  and coverings to those with index  $\mathcal{M} : \mathcal{N} = 4$ .

Since Jones inclusions are interpreted in terms of finite measurement resolution, the mathematical realization of this heuristic picture should rely on the same concept realized also by the fact that the number of non-zero modes for induced spinor fields is finite. This allows to consider two possible interpretations.

1. The finite number of modes defines an approximation to the hyper-finite factor of type  $II_1$  defined by configuration space Clifford algebra.
2. The Clifford algebra spanned by fermionic oscillator operators is quantum Clifford algebra and corresponds to the somewhat nebulous object  $\mathcal{N}/\mathcal{M}$  associated with the inclusion  $\mathcal{M} \subset \mathcal{N}$  and coding the finite measurement resolution to a finite quantum dimension of the Clifford algebra.



The fact that quantum dimension is smaller than the actual dimension would reflect correlations between spinor components so that they are not completely independent.

If the latter interpretation is correct then second quantized induced spinor fields should obey quantum variant of anticommutation relations reducing to ordinary anticommutation relations only for  $n_a = n_b = 0$  (no singular coverings nor factor spaces). This would give the desired connection between inclusions and hierarchy of Planck constants. It is possible to have infinite number of quantum group like structure for  $\hbar = \hbar_0$ .

There are two quantum phases  $q$  and one should understand what is the phase that appears in the quantum variant of anti-commutation relations. A possible resolution of the problem relies on the observation that there are two kinds of number theoretic braids. The first kind of number theoretic braid is defined as the intersection of  $M_+$  (or light-like curve of  $\delta M_+^4$  in more general case) and of  $\delta M_+^4$  projection of  $X^2$ . Second of braid is defined as the intersection of  $CP_2$  projection of  $X^2$  of homologically non-trivial sphere  $S_{II}^2$  of  $CP_2$ . The intuitive expectation is that these dual descriptions apply for light-like 3-surfaces associated *resp.* co-associative regions of space-time surface and that both descriptions apply at wormhole throats. The duality of these descriptions is guaranteed also at wormhole throats if physical Planck constant is given by  $\hbar = r\hbar_0$ ,  $r = \hbar(M^4)/\hbar(CP_2)$ , so that only the ratio of the two Planck constants matters in commutation relations. This would suggest that it is  $q = \exp(i2\pi/r)$ , which appears in quantum variant of anti-commutation relations of the induced spinor fields.

### The action of $G_a \times G_b$ on configuration space spinors and spinor fields

The first question is what kind of measurement resolution is in question. In zero energy ontology the included states would typically correspond to insertion of zero energy states to the positive or negative part of the physical state in time scale below the time resolution defined by the time scale assignable to the smallest  $CD$  present in the zero energy state. Does the description in terms of  $G$  invariance apply in this case or does it relate only to time and length scale resolution whereas hierarchy of Planck constants would relate to angle resolution? Assume that this is the case.

The second question is how the idea about  $\mathcal{M}$  as an included algebra defining finite measurement resolution and  $G$  invariance as a symmetry defining  $\mathcal{M}$  as the included algebra relate to each other.

1. One cannot say that  $G$  creates states, which cannot be distinguished from each other. Rather  $G$ -invariant elements of  $\mathcal{M}$  create states whose presence in the state cannot be detected.
2. For covering space option  $\mathcal{M}$  represents states which are invariant under discrete subgroup of  $SU(2)$  acting in the covering. States with integer spin would be below measurement resolution and only fractional spins of form  $j/n$  would be observable. For factor space option  $\mathcal{M}$  would represent states which are invariant under discrete subgroup of  $SU(2)$  acting in  $H$ -say states with spin. States with spin which is multiple of  $n$  would be below measurement resolution. The situation would be very similar to each other. Number theoretic considerations and the fact that the number of fermionic oscillator operators is finite suggest that that for coverings the condition  $L_z < 1$  and for factor spaces the condition  $L_z < n$  is satisfied by the generators of Clifford algebra regarded as irreducible representation of  $G$ . For factor spaces the interpretation could be in terms of finite angular resolution  $\Delta\phi \leq 2\pi/n$  excluding angular momenta  $L_z \geq n$ . For coverings the resolution would be related to rotations (or rather, braidings) as multiples of  $2\pi$ : multiples  $m2\pi$   $m \geq n$  cannot be distinguished from  $m \bmod n$  multiples.
3. The minimal assumption is that integer orbital angular momenta are excluded for coverings and  $n$ -multiples are excluded for factor spaces. The stronger assumption would be that there is angular momentum cutoff. This point is however very delicate. The states with  $j > n$  can be obtained as tensor products of representations with  $j = m$ . If entanglement is present one cannot anymore express the state as a product of  $\mathcal{M}$  element and  $\mathcal{N}$  element so that the states  $j > n$  created in this manner would not be equivalent with those with  $j \bmod n$ . The replacement of the ordinary tensor product with Connes tensor product would indeed generate automatically entangled states and one could interpret Connes tensor product as a manner to create only the allowed states.

4. For quantum groups allow only finite number of representations up to some maximum spin determined by the integer  $n$  characterizing quantum phase  $q$ . This would mean angular momentum cutoff leaving only a finite number of representations of quantum group [K8] . This fits nicely with what one obtains in the case of factor spaces. For coverings the new element is that the unit of spin becomes  $1/n$ : otherwise the situation seems to be similar. Quantum group like structure is obtained if the fermionic oscillator operators satisfy the quantum version of anti-commutation relations. The algebra would be very similar except that the orbital angular momentum labeling oscillator operators has different unit. Oscillator operators are naturally in irreducible representations of  $G$  and only the non-trivial representations of  $G$  are allowed.
5. Besides Jones inclusions corresponding to  $\mathcal{M} : \mathcal{N} < 4$  there are inclusions with  $\mathcal{M} : \mathcal{N} = 4$  to which one can also assign quantum phases. It would be natural to assign covering spaces and factor spaces to these two kinds of inclusions. For the minimal option excluding only the orbital angular momentum which are integers or multiples of  $n$  the fraction of excluded states is very small for coverings so that  $\mathcal{M} : \mathcal{N} = 4$  is natural for this option.  $\mathcal{M} : \mathcal{N} < 4$  would in turn correspond naturally to factor spaces.
6. Since the two kinds of number theoretic braids correspond to points which belong to  $M^2$  or  $S^2$ , one might argue that several quantum anticommutation relations must be satisfied simultaneously. This is not the case since the eigen modes of  $D_{C-S}$  and hence also oscillator operators code information about partonic surface  $X^2$  itself and also about  $X^4(X_i^3)$  rather than being purely local objects. In the case of covering space the oscillator operators can be arranged to irreducible representations of  $G$  and in the case of factor space the oscillator operators are  $G$ -invariant.

One must distinguish between  $G$  invariance for configuration space spinors and spinor fields.

1. In the case of factor spaces 3-surface are  $G$  invariant so that there is no difference between spinors and spinor fields as far as  $G$  is considered. Irreducible representations of  $G$  would correspond to the superpositions of  $G$ -transforms of oscillator operators for a fixed  $G$ -invariant  $X_i^3$ .
2. For covering space option  $G$ -invariance would mean that 3-surface is a mere  $G$ -fold copy of single 3-surface. There is no obvious reason to assume this. Hence one cannot separate spinorial degrees of freedom from configuration space degrees of freedom since  $G$  affects both the spin degrees of freedom and the 3-surface. Irreducible representations of  $G$  would correspond to genuine configuration space spinor fields involving a superposition of  $G$ -transforms of also  $X_i^3$ . The presence of both orbital and spin degrees of freedom could provide alternative explanation for why  $\mathcal{M} : \mathcal{N} = 4$  holds true for covering space option.

If the fermionic oscillator algebra is interpreted as a representation for  $\mathcal{N}/\mathcal{M}$ , allowed fermionic oscillator operators belong to non-trivial irreps of  $G$ . One can however ask whether the many-fermion states created by these operators are  $G$ -invariant for some physical reason so that one would have kind of  $G$ -confinement forcing the states to be many-fermion states with standard unit of quantum numbers for coverings and integer multiples of  $n$  for factor spaces. This would conform with the ideas that anyonicity is a microscopic property not visible at the level of entire state and that many-fermion systems in the anyonic state resulting in strong coupling limit for ordinary value of  $\hbar$  are in question. The processes changing the value of Planck constant would be phase transitions involving all fermions of the  $G$ -invariant state and would be slow for this reason. This would also contribute to the invisibility of dark matter.

### 15.2.3 Questions

#### What is the role of dimensions?

Could the dimensions of  $CD$  and  $CP_2$  and the dimensions of spaces defined by the choice of the quantization axes play a fundamental role in the construction from the constraint that the fundamental group is non-trivial?

1. Suppose that the sub-manifold in question is geodesic sub-manifold containing the orbits of its points under Cartan subgroup defining quantization axes. A stronger assumption would be that the orbit of maximal compact subgroup is in question.

2. For  $M^{2n}$  Cartan group contains translations in time direction with orbit  $M^1$  and Cartan subgroup of  $SO(2n - 1)$  and would be  $M^n$  so that  $\hat{M}^{2n}$  would have a trivial fundamental group for  $n > 2$ . Same result applies in massless case for which one has  $SO(1, 1) \times SO(2n - 2)$  acts as Cartan subgroup. The orbit under maximal compact subgroup would not be in question.
3. For  $CP_2$  homologically non-trivial geodesic sphere  $CP_1$  contains orbits of the Cartan subgroup. For  $CP_n = SU(n + 1)/SU(n) \times U(1)$  having real dimension  $2n$  the sub-manifold  $CP_{n-1}$  contains orbits of the Cartan subgroup and defines a sub-manifold with codimension 2 so that the dimensional restriction does not appear.
4. For spheres  $S^{n-1} = SO(n)/SO(n - 1)$  the dimension is  $n - 1$  and orbit of  $SO(n - 1)$  of point left fixed by Cartan subgroup  $SO(2) \times ..$  would for  $n = 2$  consist of two points and  $S_{n-2}$  in more general case. Again co-dimension 2 condition would be satisfied.

**What about holes of the configuration space?**

One can raise analogous questions at the level of configuration space geometry. Vacuum extremals correspond to Lagrangian sub-manifolds  $Y^2 \subset CP_2$  with vanishing induced Kähler form. They correspond to singularities of the configuration space ("world of classical worlds") and configuration space spinor fields should vanish for the vacuum extremals. Effectively this would mean a hole in configuration space, and the question is whether this hole could also naturally lead to the introduction of covering spaces and factor spaces of the configuration spaces. How much information about the general structure of the theory just this kind of decomposition might allow to deduce? This kind of singularities are infinite-dimensional variants of those discussed in catastrophe theory and this suggests that their understanding might be crucial.

**Are more general inclusions of HFFs possible?**

The proposed scenario could be criticized because discrete subgroups of  $SU(2)$  are in a preferred position. The Jones inclusions considered correspond to quantum spinor representations of various quantum groups  $SU(2)_q, q = exp(i2\pi/n)$ . This explains the result  $\mathcal{M} : \mathcal{N} \leq 4$ . These representations are certainly in preferred role as far as configuration space spinor fields are considered but it is possible to assign a hierarchy of inclusions of HFFs labeled by quantum phase  $q$  with arbitrary representation of an arbitrary compact Lie group. These inclusions would be analogous to discrete states in the continuum  $\mathcal{M} : \mathcal{N} > 4$ .

Since the inclusions are characterized by single quantum phase  $q = exp(i2\pi/n)$  in the case of compact Lie groups (Appendix), one can ask whether more general discrete groups than subgroups of  $SU(2)$  should be allowed. The inclusions of HFFs associated with higher dimensional Lie groups have  $\mathcal{M} : \mathcal{N} > 4$  and are analogous to bound states in continuum (Appendix). In the case of  $CP_2$  this would allow to consider much more general sub-groups.

The question is therefore whether some principle selects subgroups of  $SU(2)$ . There are indeed good arguments supporting the hypothesis that only discrete Abelian subgroups of  $SU(2)$  are possible.

1. The notion of number theoretic braid allows only the only subgroups of rotation group leaving  $M^2$  invariant and sub-groups of  $SU(3)$  leaving geodesic sphere  $S^2_i$  invariant. This would drop groups having genuinely 3-D action. In the case of  $SU(3)$  discrete subgroups of  $SO(3)$  or  $U(2)$  remain under consideration. The geodesic sphere of type II is however analogous to North/South pole of  $S^2$  and second phase factor associated with the coordinates  $(\xi^1, \xi^2)$  becomes redundant since  $(|\xi^1|^2 + |\xi^2|^2)^{1/2}$  becomes infinite at  $S^2_{II}$  so that  $\xi^1/\xi^2$  becomes appropriate coordinate. Hence action of  $U(2)$  reduces to that of  $SU(2)$  since  $\xi^1$  and  $\xi^2$  correspond to same value of color hyper charge associated with  $U(1)$ .
2. A physically attractive possibility is that  $G_a \times G_b$  leaves the choice of quantization axes invariant. This condition makes sense also for coverings. This would leave only Abelian groups into consideration and drop  $D_{2n}, E_6,$  and  $E_8$ . It is quite possible that only these groups define sectors of the generalized imbedding space. This means that  $G_b = Z_{n_1} \times Z_{n_2} \subset U(1)_I \times U(1)_Y \subset SU(2) \times U(1)_Y$  and even more general subgroups of  $SU(3)$  (if non-commutativity is allowed) are a priori possible. Again the first argument reduces the list to cyclic subgroups of  $SU(2)$ .

3. The products of groups  $Z_n$  are also number theoretically in a very special position since they relate naturally to the finite cyclic extensions and also to the maximal Abelian extension of rationals. With this restriction on  $G_a \times G_b$  one can consider the hypothesis that elementary particles correspond are maximally quantum critical systems left invariant by all groups  $G_a \times G_b$  respecting a given choice of quantization axis and implying that darkness is associated only to field bodies and Planck constant becomes characterizer of interactions rather than elementary particles themselves.

## 15.3 Some mathematical speculations

### 15.3.1 The content of McKay correspondence in TGD framework

The possibility to assign Dynkin diagrams with the inclusions of  $II_1$  algebras is highly suggestive concerning possible physical interpretations. The basic findings are following.

1. For  $\beta = \mathcal{M} : \mathcal{N} < 4$  Dynkin diagrams code for the inclusions and correspond to simply laced Lie algebras.  $SU(2)$ ,  $D_{2n+1}$ , and  $E_7$  are excluded.
2. Extended ADE Dynkin diagrams coding for simply laced ADE Kac Moody algebras appear at  $\beta = 4$ . Also  $SU(2)$  Kac Moody algebra appears.

#### Does TGD give rise to ADE hierarchy of gauge theories

The first question is whether any finite subgroup  $G \subset SU(2)$  acting in  $CP_2$  degrees of freedom could somehow give rise to multiplets of the corresponding gauge group having interactions described by a gauge theory. Orbifold picture suggests that might be the case.

1. The "sheets" for the space-time sheet forming an  $N(G)$ -fold cover of  $CD$  are in one-one correspondence with group  $G$ . This degeneracy gives rise to additional states and these states correspond to the group algebra having basis given by group characters  $\chi(g)$ . One obtains irreducible representations of  $G$  with degeneracies given by their dimensions. Altogether one obtains  $N(G)$  states in this manner. In the case of  $A(n)$  the number of these states is  $n + 1$ , the number of the states of the fundamental representation of  $SU(n + 1)$ . In the same manner, for  $D_{2n}$  the number of these states equals to the number of states in the fundamental representation of  $D_{2n}$ . It seems that the rule is quite general. Thus these representations would in the case of fermions give the states of the fundamental representation of the corresponding gauge group.
2. From fermion and antifermion states one can construct in a similar manner pairs giving  $N(G)^2$  states defining in the case of  $A(n)$   $n^2 - 1$ -dimensional gauge boson multiplet plus singlet. Also other groups must give boson multiplet plus possible other multiplets. For instance, for  $D(4)$  the number of states is 64 and boson multiplet is 8-dimensional so that many other spin 1 states result.
3. These findings give hopes that the orbifold multiplets could be modelled by a gauge theory based on corresponding gauge group. What is nice that this huge hierarchy of gauge theories is associated with dark matter so that the predictivity and falsifiability are not lost unlike in M-theory.

#### Does one obtain also a hierarchy of conformal theories with ADE Kac Moody symmetry?

Consider next the question Kac Moody interactions correspond to extended ADE diagrams are possible.

1. In this case the notion of orbifold seems to break down since the symmetry related points form a continuum  $SU(2)$  and space-time surface would become 6-dimensional if the  $CD$  projection is 4-dimensional. If one takes space-time as something which emerges, one could take this possibility half seriously. A more natural natural possibility is that  $CD$  projection is 2-dimensional geodesic sphere in which case one would have string like objects so that conformal field theory with Kac-Moody algebra would emerge naturally.

2. The new degrees of freedom would define 2-dimensional continuum and it would not be completely surprising if conformal field theory based on ADE Kac Moody algebra could describe the situation. One possibility is that these continua for different inclusions correspond to  $SU(2)$  decompose to an  $N(G)$ -fold covers of  $S^2/G$  orbifold so that also now groups  $G$  would be involved with the Jones inclusions, which might provide a hint about how to construct them.  $S^2/G$  would play the role of stringy world sheet for the conformal field theory in question. This effective re-arrangement of the topology  $S^2$  might be due to the fact that conformal fields possess  $G$  symmetry which effectively groups points of  $S^2$  to  $n(G)$ -multiplets. The localized representations of the Lie group corresponding to  $G$  would correspond to the multiplets obtained from the representations of group algebra of  $G$  as in previous case.
3. The formula for the scaling factor of  $CD$  metric would give infinite scaling factor if one identifies the scaling factor as maximal order of cyclic subgroup of  $SU(2)$ . As a matter fact there is no finite cyclic subgroup of this kind. The solution to the problem would be identification of the scaling factor as the order of the maximal cyclic subgroup of  $G$  so that the scaling factors would be same for the two situations related by McKay correspondence.

### Generalization to $CD$ degrees of freedom

One can ask whether the proposed picture generalizes formally also the case of  $CD$ .

1. In this case quantum groups would correspond to discrete subgroups  $G \subset SL(2, C)$ . Kac Moody group would correspond to  $G$ -Kac Moody algebra made local with respect to  $SL(2, C)$  orbit in  $CD$  divided by  $G$ . These orbits are 3-dimensional hyperboloids  $H_a$  with a constant value of light cone proper time  $a$  so that the division by  $G$  gives fundamental domain  $H_a/G$  with a finite 3-volume.
2. The 4-dimensionality of space-time would require 1-dimensional  $CP_2$  projection. Vacuum extremals of Kähler action would be in question. Robertson-Walker metric have 1-dimensional  $CP_2$  projection and carry non-vanishing density of gravitational mass so that in this sense the theory would be non-trivial.  $G$  would label different lattice like cosmologies defined by tessellations with fundamental domain  $H_a/G$ .
3. The multiplets of  $G$  would correspond to collections of points, one from each cells of the lattice like structure. Macroscopic quantum coherence would be realized in cosmological scales. If one takes seriously the vision about the role of short distance p-adic physics as a generator of long range correlations of the real physics reflected as p-adic fractality, this idea does not look so weird anymore.

Complexified modular group  $SL(2, Z + iZ)$  and its subgroups are interesting as far as p-adicization is considered. The principal congruence subgroups  $\Gamma(N)$  of  $SL(2, Z + iZ)$  which are unit matrices modulo  $N$  define normal subgroups of the complex modular group and are especially interesting candidates for groups  $G \subset SL(2, C)$ . The group  $\Gamma(N = p^k)$  labeling fundamental domains of the tessellation  $H_a/\Gamma(N = p^k)$  defines a mathematically attractive candidate for a point set associated with the intersections of p-adic space-time sheets with real space-time sheets. Also analogous groups for algebraic extensions of  $Z$  are interesting.

The simplest discrete subgroup of  $SL(2, C)$  with infinite number of elements would corresponds to powers of boost to single direction and correspond at the non-relativistic limit to multiples of basic velocity. This could also give rise to quantization of cosmic recession velocities. There is evidence for the quantization of cosmic recession velocities (for a model in which single object produces quantized redshifts see [K18] ) and it is interesting to see whether they could be interpreted in terms of the lattice like periodicity in cosmological length scales implied by the effective reduction of physics to  $M_+^4/G_n$ . In [?] the values  $z = 2.63, 3.45, 4.47$  of cosmic red shift are listed. These correspond to recession velocities  $v = (z^2 - 1)/(z^2 + 1)$  are (0.75, 0.85, 0.90). The corresponding hyperbolic angles are given by  $\eta = \text{acosh}(1/(1 - v^2))$  and the values of  $\eta$  are (1.46, 1.92, 2.39). The differences  $\eta(2) - \eta(1) = .466$  and  $\eta(3) - \eta(2) = .467$  are same within experimental uncertainties. One has however  $\eta(n)/(\eta(2) - \eta(1)) = (3.13, 4.13, 5.13)$  instead of (3, 4, 5). A possible interpretation is in terms of the velocity of the observer with respect to the frame in which quantization of  $\eta$  happens.

**Quantitative support for the interpretation**

A more detailed analysis of the situation gives support for the proposed vision.

1. A given value of quantum group deformation parameter  $q = \exp(i\pi/n)$  makes sense for any Lie algebra but now a preferred Lie-algebra is assigned to a given value of quantum deformation parameter. At the limit  $\beta = 4$  when quantum deformation parameter becomes trivial, the gauge symmetry is replaced by Kac Moody symmetry.
2. The prediction is that Kac-Moody central extension parameter should vanish for  $\beta < 4$ . There is an intriguing relationship to formula for the quantum phase  $q_{KM}$  associated with (possibly trivial) Kac-Moody central extension and the phase defined by ADE diagram

$$\begin{aligned} q_{KM} &= \exp(i\phi) \ , \quad \phi_1 = \frac{\pi}{k+h^v} \ , \\ q_{Jones} &= \exp(i\phi) \ , \quad \phi = \frac{\pi}{h} \end{aligned}$$

In the first formula sum of Kac-Moody central extension parameter  $k$  and dual Coxeter number  $h^v$  appears whereas Coxeter number  $h$  appears in the second formula. Internal consistency requires

$$k + h^v = h \ . \tag{15.3.1}$$

It is easy see that the dual Coxeter number  $h^v$  and Coxeter number  $h$  given by  $h = (\dim(g)-r)/r$ , where  $r$  is the dimension of Cartan algebra of  $g$ , are identical for ADE algebras so that the Kac-Moody central extension parameter  $k$  must indeed vanish. For  $SO(2n + 1)$ ,  $Sp(n)$ ,  $G_2$ , and  $F_4$  the condition  $h = h^v$  does not hold true but one has  $h(n) = 2n = h^v + 1$  for  $SO(2n + 1)$ ,  $h(n) = 2n = 2(h^v - 1)$  for  $Sp(n)$ ,  $h = 6 = h^v + 2$  for  $G_2$ , and  $h = 12 = h^v + 3$  for  $F_4$ .

What is intriguing that  $G_2$ , which seems to play a fundamental role in the dual formulation of quantum TGD based on the identification of space-times as surfaces in hyper-octonionic space  $M^8$  [K72] is not allowed. As a matter fact,  $G_2 \rightarrow SU(3)$  reduction occurs also in the dual formulation based on  $G_2/SU(3)$  coset model and is required by the separate conservation of quark and lepton numbers predicted by TGD. ADE groups would be associated with the interaction between space-time sheets rather than entire dynamics and need not have anything to do with the Kac-Moody algebra associated with color and electro-weak interactions appearing in the construction of physical states [K39] .

3. There seems to be a concrete connection with conformal field theories. This connection would allow to understand the emergence of quantum groups appearing naturally in these theories. Quite generally, the conformal central extension parameter for unitary Virasoro representations resulting by Sugawara construction from Kac Moody representations satisfies either of the conditions

$$\begin{aligned} c &\geq \frac{k \dim(g)}{k + h^v} + 1 \ , \\ c &= \frac{k \dim(g)}{k + h^v} + 1 - \frac{6}{(h - 1)h} \ . \end{aligned} \tag{15.3.2}$$

For  $k = 0$ , which should be interesting for  $\beta < 4$ , the second formula reduces to

$$c = 1 - \frac{6}{(h - 1)h} \ . \tag{15.3.3}$$

The formula gives the values of  $c$  for minimal conformal field theories with finite number of conformal fields and real conformal weights. Indeed,  $h$  in this formula seems to correspond to the same  $h$  as appearing in the expression  $\beta \equiv \mathcal{M} : \mathcal{N} = 4\cos^2(\pi/h)$  .

$\beta = 3, h = 6$  corresponds to three-state Potts model with  $c = 4/5$  which should thus have a gauge group for which Coxeter number is 6: the group should be either  $SU(6)$  or  $SO(8)$ . Two-state Potts model, that is Ising model with  $\beta = 2, h = 4$  would correspond to  $c = 1/2$  and to a gauge group  $SU(4)$  or  $SO(4)$ . For  $h = 3$  ("one-state Potts model") with group  $SU(3)$  one would have  $c = 0$  and vanishing conformal anomaly so that conformal degrees of freedom would become pure gauge degrees of freedom.

These observations give support for the following picture.

1. Quite generally, the number of states of the generalized  $\beta$ -state Potts model has an interpretation as the dimension  $\beta = \mathcal{M} : \mathcal{N}$  of  $\mathcal{M}$  as  $\mathcal{N}$ -module. Besides the models with integer number of states there is an infinite number of models for which the number of states is not an integer. The conditions  $c \leq 1$  guaranteeing real conformal weights and  $\beta \leq 4$  correspond to each other for these models.
2.  $\beta > 4$  Potts models would be formally obtained by allowing  $h$  to be imaginary in the defining formula for  $\mathcal{M} : \mathcal{N}$ . In this case  $c$  would be however complex so that the theory would not be unitary.
3. For minimal models with ( $\beta < 4, c < 1$ ) Kac-Moody central extension parameter is vanishing so that Kac Moody algebra indeed acts like gauge symmetries and gauge symmetries would be in question. ( $\beta = 4, c = 1$ ) would define a "four-state Potts model" with infinite-dimensional unitary group acting as a gauge group. On the other hand, the appearance of extended ADE Dynkin diagrams suggests strongly that this limit is not realized but that  $\beta = \mathcal{M} : \mathcal{N} = 4$  corresponds to  $k = 1$  conformal field theory allowing Kac Moody symmetries for any ADE group, which as simply-laced groups allows vertex operator construction. The appearance of  $kdim(g)/(k + g)$  in the more general formula would thus code the Kac Moody group whereas for  $\beta < 4$  ADE diagram codes for the preferred gauge group characterizing the minimal CFT.
4. The possibility that any ADE gauge group or Kac-Moody group can characterize the interaction between space-time sheets conforms with the idea about Universe as a Topological Quantum Computer able to simulate any conceivable quantum dynamics. Of course, one cannot exclude the possibility that only electro-weak and color symmetries are realized in this manner.

### $G_a$ as a symmetry group of magnetic body and McKay correspondence

The group  $G_a \subset SU(2) \subset SL(2, C)$  means exact rotational symmetry realized in terms of  $CD$  coverings of  $CP_2$ . The 5 and 6-cycles in biochemistry (sugars, DNA,...) are excellent candidates for these symmetries. For very large values of Planck constant, say for the values  $\hbar(CD)/\hbar(CP_2) = GMm/v_0 = (n_a/n_b)\hbar_0$ ,  $v_0 = 2^{-11}$ , required by the model for planetary orbits as Bohr orbits [K65],  $G_a$  is huge and corresponds to either  $Z_{n_a}$  or in the case of even value of  $n_a$  to the group generated by  $Z_n$  and reflection acting on plane and containing  $2n_a$  elements.

The notion of magnetic body seems to provide the only conceivable candidate for a geometric object possessing  $G_a$  as symmetries. In the first approximation the magnetic field associated with a dark matter system is expected to be modellable as a dipole field having rotational symmetry around the dipole axis. Topological quantization means that this field decomposes into flux tube like structures related by the rotations of  $Z_n$  or  $D_{2n}$ . Dark particles would have wave functions delocalized to this set of these flux quanta and span group algebra of  $G_a$ . Magnetic flux quanta are indeed assumed to mediate gravitational interactions in the TGD based model for the quantization of radii of planetary orbits and this explains the dependence of  $\hbar_{gr}$  on the masses of planet and central object [K65] .

For the model of dark matter hierarchy appearing in the model of living matter one has  $n_a = 2^{11k}$ ,  $k = 1, 2, 3, \dots, 7$  for cyclotron time scales below life cycle for a magnetic field  $B_d = .2$  Gauss at  $k = 4$  level of hierarchy (the field strength is fixed by the model for the effects of ELF em fields on vertebrate brain at harmonics of cyclotron frequencies of biologically important ions [K22] ). Note that  $B_d$  scales as  $2^{-11k}$  from the requirement that cyclotron energy is constant.

ADE correspondence between subgroups of  $SU(2)$  and Lie groups in ADE hierarchy encourages to consider the possibility that TGD could mimic ADE hierarchy of gauge theories. In the case of  $G_a$  this would mean that many fermion states constructed from single fermion states, which are in one-one correspondence with the elements of  $G_a$  group algebra, would define multiplets of the gauge group corresponding to the Dynkin diagram characterizing  $G_a$ : for instance,  $SU(n_a)$  in the case of  $Z_{n_a}$ . Fermion multiplet would contain  $n_a$  states and gauge boson multiplet  $n_a^2 - 1$  states. This would provide enormous information processing capacity since for  $n_a = 2^{11k}$  fermion multiplet would code exactly  $11k$  bits of information. Magnetic body could represent binary information using the many-particle states belonging to the representations of say  $SU(n_a)$  at its flux tubes.

### 15.3.2 Jones inclusions, the large $N$ limit of $SU(N)$ gauge theories and AdS/CFT correspondence

The framework based on Jones inclusions has an obvious resemblance with larger  $N$  limit of  $SU(N)$  gauge theories and also with the celebrated AdS/CFT correspondence [?] so that a more detailed comparison is in order.

#### Large $N$ limit of gauge theories and series of Jones inclusions

The large  $N$  limit of  $SU(N)$  gauge field theories has as definite resemblance with the series of Jones inclusions with the integer  $n \geq 3$  characterizing the quantum phase  $q = \exp(i\pi/n)$  and the order of the maximal cyclic subgroup of the subgroup of  $SU(2)$  defining the inclusion. Recall that all ADE groups except  $D_{2n+1}$  and  $E_7$  are allowed ( $SU(2)$  is excluded since it would correspond to  $n = 2$ ).

The limiting procedure keeps the value of  $g^2 N$  fixed. Rather remarkably, this is equivalent with keeping  $\alpha N$  constant but assuming  $\hbar$  to scale as  $n = N$ . Thus the quantization of Planck constants would provide a physical laboratory for the testing of large  $N$  limit.

The observation suggesting a description of YM theories in terms of closed strings is that Feynman diagrams can be interpreted as being imbedded at closed 2-surfaces of minimal genus guaranteeing that the internal lines meet except in vertices. The contribution of genus  $g$  diagrams is proportional to  $N^{g-1}$  at the large  $N$  limit. The interpretation in terms of closed partonic 2-surfaces is highly suggestive and the  $N^{g-1}$  should come from the multiple covering property of  $CP_2$  by  $N$   $CD$ -points (or vice versa) with the finite subgroup of  $G \subset SU(2)$  defining the Jones inclusion and acting as symmetries of the surface.

#### Analogy between stacks of branes and multiple coverings of $CD$ and $CP_2$

An important aspect of AdS/CFT dualities is a prediction of an infinite hierarchy of gauge groups, which as such is as interesting as the claimed dualities. The prediction relies on the notion  $Dp$ -branes.  $Dp$ -branes are  $p + 1$ -dimensional surfaces of the target space at which the ends of open strings can end. In the simplest situation one considers  $N$  parallel  $p$ -branes at the limit when the distances between branes characterized by an expectation value of Higgs fields approach zero to obtain what is called  $N$ -stack of branes. There are  $N^2$  different strings connecting the branes and the heuristic idea is that they correspond to gauge bosons of  $U(N)$  gauge theory. Note that the requirement that AdS/CFT dualities exist forces the introduction of branes and the optimistic interpretation is that a non-perturbative effect of still unknown M-theory is in question. In the limit of an ideal stack one assumes that  $U(N)$  gauge theory at the brane representing the stack is obtained. The branes must also carry a  $p$ -form defining gauge potential for a closed  $p + 1$ -form. This Ramond charge is quantized and its value equals to  $N$ .

Consider now the group  $G_a \times G_b \subset SL(2, C) \times SU(2) \subset SU(3)$  defining double Jones inclusion and implying the scalings  $\hbar(M^4) \rightarrow n(G_b)\hbar(M^4)$  and  $\hbar(CP_2) \rightarrow n(G_a)\hbar(CP_2)$ . These space-time surfaces define  $n(G_a)$ -fold multiple coverings of  $CP_2$  and  $n(G_b)$ -fold multiple coverings of  $CD$ . In  $CP_2$  degrees of freedom the collection of  $G_b$ -related partonic 2-surfaces ( $/3$ -surfaces/ $4$ -surfaces) is highly analogous to the stack of branes. In  $CD$  degrees of freedom the stack of copies of surface typically correspond to along a circle ( $A_n, D_{2n}$  or at vertices of tetrahedron or isosahedron).

In TGD framework the interpretation strings are not needed to define gauge fields. The group algebra of  $G$  realized as discrete plane waves at  $G$ -orbit gives rise to representations of  $G$ . The



hypothesis supported by few examples is that these additional degrees of freedom allow to construct multiplets of the gauge group assignable to the ADE diagram characterizing the inclusion.

### AdS/CFT duality

AdS/CFT duality is a further aspect of the brane construction. The dual description of the situation is in terms of a string theory in a background in which  $N$ -brane acts as a macroscopic object giving rise to a black-hole like object in (say) 10-dimensional target space. This background has the form  $AdS_5 \times X_5$ , where  $AdS_5$  is 5-dimensional hyperboloid of  $M^6$  and thus allows  $SO(4, 2)$  as isometries.  $X_5$  is compact constant curvature space.  $S^5$  gives rise to  $N = 4$  SUSY in  $M^4$  with  $M^4$  interpreted as a brane. The first support for the dualities comes from the symmetries: for instance, the  $N = 4$  super-symmetrized isometries of  $AdS_5 \times S^5$  are same as the symmetries of 4-dimensional  $N = 4$  SUSY for  $p = 3$  branes.  $N$ -branes can be used as models for black holes in target space and black-hole entropy can be calculated using either target space picture or conformal field theory at brane and the results turn out to be the same.

Does the TGD equivalent of this duality exist in some sense?

1. As far as partonic 2-surfaces identified as 1-branes are considered, conformal field theory description is trivially true. In TGD framework the analog of Ramond charges are the integers  $n_a$  and  $n_b$  characterizing the multiplicities of the maximal Abelian subgroups having clear topological meaning. This conforms with the observation that large  $N$  limit of the gauge field theories can be formulated in terms of closed surfaces at which the Feynman diagrams are imbedded without self crossings. It seems that the integers  $n_a$  and  $n_b$  characterizing the Jones inclusion naturally take the role of Ramond charge: this does not of course exclude the possibility they can be expressed as fluxes at space-time level as will be indeed found.
2. Conformal field theory description can be generalized in the sense that one replaces the  $n(G_a) \times n(G_b)$  partonic surfaces with single one and describes the new states as primary fields arranged into representations of the ADE group in question. This would mean that the standard model gauge group extends by additional factor which is however non-trivially related to it.
3. If one can accept the idea that the conformal field theory description for partons gives rise to  $M^4$  gauge theory as an approximate description, it is not too difficult to imagine that also ADE hierarchy of gauge theories results as a description of the exotic states. One can say that CFT in  $p$ -brane is replaced now with CFT on partonic 2-surface (1-brane) analogous to a closed string.
4. In the minimal interpretation there is no need to add strings connecting the branches of the double covering of the partonic 2-surface whose function is essentially that of making possible gauge bosons as fermion anti-fermion pairs. One could of course imagine gauge fluxes as counterparts of strings but just the fact that  $G$ -invariance dictates the configurations completely forces to question this kind of dynamics.
5. There is no reason to expect the emergence of  $N = 4$  super-symmetric field theory in  $M^4$  as in the case of super-string models. The reasons should be already obvious: super-conformal generators  $G$  anticommute to  $L_0$  proportional to mass squared rather than four-momentum and the spectrum extended by  $G_a \times G_b$  degeneracy contains more states.

One can of course ask whether higher values of  $p$  could make sense in TGD framework.

1. It seems that the light-like orbits of the partonic 2-surfaces defining 2-branes do not bring in anything new since the generalized conformal invariance makes it possible the restriction to a 2-dimensional cross section of the light like causal determinant.
2. The idea of regarding space-time surface  $X^4$  as a 3-brane in  $H$  in which some kind of conformal field theory is defined is in conflict with the basic ideas of TGD. The role of  $X^4$  interior is to provide classical correlates for quantum dynamics to make possible quantum measurement theory and also introduce correlations between partonic 2-surfaces even in the case that partonic conformal dynamics reduces to a topological string theory. It is quantum classical correspondence which corresponds to this duality.

### What is the counterpart of the Ramond charge in TGD?

The condition that there exist a  $p$ -form defining  $p + 1$ -gauge field with  $p$ -charge equal to  $n_a$  or  $n_b$  is a rather stringent additional condition also in TGD framework. For  $n < \infty$  this kind of charge is defined by Jones inclusion and represented topologically so that Ramond charge is not needed in  $n < \infty$  case. By the earlier arguments one must however be able to assign integers  $n_a$  and  $n_b$  also to  $G = SU(2)$  inclusions with Kac-Moody algebra characterized by an extended ADE diagram with the phases  $q_i = \exp(i\pi/n_i)$  relating to the monodromy of the theory. Since Jones inclusion does not define in this case the value of  $n < \infty$  in any obvious manner, the counterpart of the Ramond charge is needed.

1. For partonic 2-surfaces ordinary gauge potential would define this form and the condition would state that magnetic flux equals to  $n$  so that the anyonic partonic two-surfaces would be homologically non-trivial in  $CP_2$  degrees of freedom. String ends would define basic example of this situation. This would be the case also in  $M^4_+$  degrees of freedom: the partonic 2-surface would essentially wind  $n_a$  times around the tip of  $\delta CD$  and the gauge field in question would be monopole magnetic field in  $\delta CD$ . This kind of situation need not correspond to anything cosmological since future and past light-cones appear in the basic definition of the scattering amplitudes.
2. For  $p = 3$  Chern-Simons action for the induced  $CP_2$  Kähler form associated with the partonic 2-surface indeed defines this kind of charge. Ramond charge should be simply  $N$ .  $CP_2$  type extremals or their small deformations satisfy this constraint and are indeed very natural in elementary particle physics context but too restrictive in a more general context.

Note that the light-like orbits of non-deformed  $CP_2$  extremals have light-like random curve as an  $M^4$  projection and the conformal symmetries of  $M^4$  obviously respect light-likeness property. Hence  $SO(4, 2)$  symmetry characterizing  $AdS_5/CFT$  is not excluded but would be broken by  $p$ -adic thermodynamics and by TGD based Higgs mechanism involving the identification of inertial momentum as average value of non-conserved gravitational momentum parallel to the light-like zitterbewegung orbit.

### Can one speak about black hole like structures in TGD framework?

For  $AdS/CFT$  correspondence there is also a dynamical coupling to the target space metric. The coupling to H-metric is present also now since the overall scalings of the  $CD$  resp.  $CP_2$  metrics by  $n_b$  resp. by  $n_a$  are involved. This applies to when multiple covering is used explicitly. In the description in which one replaces the multiple covering by ordinary  $M^4 \times CP_2$ , the metric suffers a genuine change and something analogous to the black-hole type metrics encountered in  $AdS/CFT$  correspondence might be encountered.

Consider as an example an  $n_a$ -fold covering of  $CP_2$  points by  $M^4$  points (ADE diagram  $A_{n_a-1}$ ). The  $n$ -fold covering means only  $n2\pi$  rotation for the phase angle  $\psi$  of  $CP_2$  complex coordinate leads to the original point. The replacement  $\psi \rightarrow \psi/n_a$  gives rise to what would look like ordinary  $M^4 \times CP_2$  but with a modified  $CP_2$  metric. The metric components containing  $\psi$  as index are scaled down by  $1/n_a$  or  $1/n_a^2$ . Notice that  $\Psi$  effectively disappears from the dynamics at the large  $n_a$  limit.

If one uses an effective description in which covering is eliminated the metric is indeed affected at the level of imbedding space black hole like structures at the level of dynamic space might make emerge also in TGD framework at large  $N$  limit since the masses of the objects in question become large and  $CP_2$  metric is scaled by  $N$  so that  $CP_2$  has very large size at this limit. This need not lead to any inconsistencies if these phases are interpreted as dark matter. At the elementary particle level  $p$ -adic thermodynamics predicts that  $p$ -adic entropy is proportional to thermal mass squared which implies elementary particle black-hole analogy.

### Other dualities

Also quantum classical correspondence defines in a loose sense a duality justifying the basic assumptions of quantum measurement theory. The light-like orbits of 2-D partons are characterized by a generalization of ordinary 2-D conformal invariance so that CFT part of the duality would be very

natural. The dynamical target space would be replaced with the space-time surface  $X^4$  with a dynamical metric providing classical correlates for the quantum dynamics at partonic 2-surfaces. The duality in this sense cannot be however exact since classical dynamics cannot fully represent quantum dynamics.

Classical description is not expected to be unique. The basic condition on space-time surfaces assignable to a given configuration of partonic 2-surfaces associated with the surface  $X_V^3$  defining S-matrix element are posed by quantum classical correspondence. Both hyper-quaternionic and co-hyper-quaternionic space-time surfaces are acceptable and this would define a fundamental duality.

A concrete example about this HQ-coHQ duality would be the equivalence of space-time descriptions using 4-D  $CP_2$  type extremals and 4-D string like objects connecting them. If one restricts to  $CP_2$  type extremals and string like objects of from  $X^2 \times Y^2$ , the target space reduces effectively to  $M^4$  and the dynamical degrees of freedom correspond in both cases to transversal  $M^4$  degrees of freedom. Note that for  $CP_2$  type extremals the conditions stating that random light-likeness of the  $M^4$  projection of the  $CP_2$  type extremal are equivalent to Virasoro conditions.  $CP_2$  type extremals could be identified as co-HQ surfaces whereas stringlike objects would correspond to HQ aspect of the duality.

HQ-coHQ provides dual classical descriptions of same phenomena. Particle massivation would be a basic example. Higgs mechanism in a gauge theory description based on  $CP_2$  type extremals would rely on zitterbewegung implying that the average value of gravitational mass identified as inertial mass is non-vanishing and is discussed already. Higgs field would be assigned to the wormhole contacts. The dual description for the massivation would be in terms of string tension and mass squared would be proportional to the distance between  $G$ -related points of  $CP_2$ .

These observations would suggest that also a super-conformal algebra containing  $SL(2, R) \times SU(2)_L \times U(1)$  or its compact version exists and corresponds to a trivial inclusion. This is indeed the case [?]. The so called large  $N = 4$  super-conformal algebra contains energy momentum current, 2+2 super generators  $G$ ,  $SU(2) \times SU(2) \times U(1)$  Kac-Moody algebra (both  $SU(2)$  and  $SL(2, R)$ ) could be interpreted as acting on  $M^4$  spin degrees of freedom, and 2 spin 1/2 fermionic currents having interpretation in terms of right handed neutrinos corresponding to two H-chiralities. Interestingly, the scalar generator is now missing.

### 15.3.3 Could McKay correspondence and Jones inclusions relate to each other?

The understanding of Langlands correspondence for general reductive Lie groups in TGD framework seems to require some physical mechanism allowing the emergence of these groups in TGD based physics. The physical idea would be that quantum dynamics of TGD is able to emulate the dynamics of any gauge theory or even stringy dynamics of conformal field theory having Kac-Moody type symmetry and that this emulation relies on quantum deformations induced by finite measurement resolution described in terms of Jones inclusions of sub-factors characterized by group  $G$  leaving elements of sub-factor invariant. Finite measurement resolution would result simply from the fact that only quantum numbers defined by the Cartan algebra of  $G$  are measured.

There are good reasons to expect that infinite Clifford algebra has the capacity needed to realize representations of an arbitrary Lie group. It is indeed known that that any quantum group characterized by quantum parameter which is root of unity or positive real number can be assigned to Jones inclusion [?]. For  $q = 1$  this would give ordinary Lie groups. In fact, all amenable groups define unique sub-factor and compact Lie groups are amenable ones.

It was so called McKay correspondence [?] which originally stimulated the idea about TGD as an analog of Universal Turing machine able to mimic both ADE type gauge theories and theories with ADE type Kac-Moody symmetry algebra. This correspondence and its generalization might also provide understanding about how general reductive groups emerge. In the following I try to cheat the reader to believe that the tensor product of representations of  $SU(2)$  Lie algebras for Connes tensor powers of  $\mathcal{M}$  could induce ADE type Lie algebras as quantum deformations for the direct sum of  $n$  copies of  $SU(2)$  algebras This argument generalizes also to the case of other compact Lie groups.

**About McKay correspondence**

McKay correspondence [?] relates discrete finite subgroups of  $SU(2)$  ADE groups. A simple description of the correspondences is as follows [?].

1. Consider the irreps of a discrete subgroup  $G \subset SU(2)$  which correspond to irreps of  $G$  and can be obtained by restricting irreducible representations of  $SU(2)$  to those of  $G$ . The irreducible representations of  $SU(2)$  define the nodes of the graph.
2. Define the lines of graph by forming a tensor product of any of the representations appearing in the diagram with a doublet representation which is always present unless the subgroup is 2-element group. The tensor product regarded as that for  $SU(2)$  representations gives representations  $j - 1/2$ , and  $j + 1/2$  which one can decompose to irreducibles of  $G$  so that a branching of the graph can occur. Only branching to two branches occurs for subgroups yielding extended ADE diagrams. For the linear portions of the diagram the spins of corresponding  $SU(2)$  representations increase linearly as  $\dots, j, j + 1/2, j + 1, \dots$

One obtains extended Dynkin diagrams of ADE series representing also Kac-Moody algebras giving  $A_n, D_n, E_6, E_7, E_8$ . Also  $A_\infty$  and  $A_{-\infty, \infty}$  are obtained in case that subgroups are infinite. The Dynkin diagrams of non-simply laced groups  $B_n (SO(2n+1))$ ,  $C_n$  (symplectic group  $Sp(2n)$  and quaternionic group  $Sp(n)$ ), and exceptional groups  $G_2$  and  $F_4$  are not obtained.

ADE Dynkin diagrams labeling Lie groups instead of Kac-Moody algebras and having one node less, do not appear in this context but appear in the classification of Jones inclusions for  $\mathcal{M} : \mathcal{N} < 4$ . As a matter fact, ADE type Dynkin diagrams appear in very many contexts as one can learn from John Baez's This Week's Finds [?] .

1. The classification of integral lattices in  $R^n$  having a basis of vectors whose length squared equals 2
2. The classification of simply laced semisimple Lie groups.
3. The classification of finite sub-groups of the 3-dimensional rotation group.
4. The classification of simple singularities . In TGD framework these singularities could be assigned to origin for orbifold  $CP_2/G, G \subset SU(2)$ .
5. The classification of tame quivers.

**Principal graphs for Connes tensor powers  $\mathcal{M}$**

The thought provoking findings are following.

1. The so called principal graphs characterizing  $\mathcal{M} : \mathcal{N} = 4$  Jones inclusions for  $G = SU(2)$  are extended Dynkin diagrams characterizing ADE type affine (Kac-Moody) algebras.  $D_n$  is possible only for  $n \geq 4$ .
2.  $\mathcal{M} : \mathcal{N} < 4$  Jones inclusions correspond to ordinary ADE type diagrams for a subset of simply laced Lie groups (all roots have same length)  $A_n (SU(n))$ ,  $D_{2n} (SO(2n))$ , and  $E_6$  and  $E_8$ . Thus  $D_{2n+1} (SO(2n+2))$  and  $E_7$  are not allowed. For instance, for  $G = S_3$  the principal graph is not  $D_3$  Dynkin diagram.

The conceptual background behind principal diagram is necessary if one wants to understand the relationship with McKay correspondence.

1. The hierarchy of higher commutations defines an invariant of Jones inclusion  $\mathcal{N} \subset \mathcal{M}$ . Denoting by  $\mathcal{N}'$  the commutant of  $\mathcal{N}$  one has sequences of horizontal inclusions defined as  $C = \mathcal{N}' \cap \mathcal{N} \subset \mathcal{N}' \cap \mathcal{M} \subset \mathcal{N}' \cap \mathcal{M}^1 \subset \dots$  and  $C = \mathcal{M}' \cap \mathcal{M} \subset \mathcal{M}' \cap \mathcal{M}^1 \subset \dots$ . There is also a sequence of vertical inclusions  $\mathcal{M}' \cap \mathcal{M}^k \subset \mathcal{N}' \cap \mathcal{M}^k$ . This hierarchy defines a hierarchy of Temperley-Lieb algebras [?] assignable to a finite hierarchy of braids. The commutants in the hierarchy are direct sums of finite-dimensional matrix algebras (irreducible representations) and the inclusion hierarchy can be described in terms of decomposition of irreps of  $k^{th}$  level to irreps of  $(k-1)^{th}$  level irreps. These decomposition can be described in terms of Bratteli diagrams [?] .

2. The information provided by infinite Bratteli diagram can be coded by a much simpler bi-partite diagram having a preferred vertex. For instance, the number of  $2k$ -loops starting from it tells the dimension of  $k^{\text{th}}$  level algebra. This diagram is known as principal graph.

Principal graph emerges also as a concise description of the fusion rules for Connes tensor powers of  $\mathcal{M}$ .

1. It is natural to decompose the Connes tensor powers [?]  $\mathcal{M}_k = \mathcal{M} \otimes_{\mathcal{N}} \dots \otimes_{\mathcal{N}} \mathcal{M}$  to irreducible  $\mathcal{M} - \mathcal{M}$ ,  $\mathcal{N} - \mathcal{M}$ ,  $\mathcal{M} - \mathcal{N}$ , or  $\mathcal{N} - \mathcal{N}$  bi-modules. If  $\mathcal{M} : \mathcal{N}$  is finite this decomposition involves only finite number of terms. The graphical representation of these decompositions gives rise to Bratteli diagram.
2. If  $\mathcal{N}$  has finite depth the information provided by Bratteli diagram can be represented in nutshell using principal graph. The edges of this bipartite graph connect  $\mathcal{M} - \mathcal{N}$  vertices to vertices describing irreducible  $\mathcal{N} - \mathcal{N}$  representations resulting in the decomposition of  $\mathcal{M} - \mathcal{N}$  irreducibles. If this graph is finite,  $\mathcal{N}$  is said to have finite depth.

### A mechanism assigning to tensor powers Jones inclusions ADE type gauge groups and Kac-Moody algebras

The earliest proposals inspired by the hierarchy of Jones inclusions is that in  $\mathcal{M} : \mathcal{N} < 4$  case it might be possible to construct ADE representations of gauge groups or quantum groups and in  $\mathcal{M} : \mathcal{N} = 4$  using the additional degeneracy of states implied by the multiple-sheeted cover  $H \rightarrow H/G_a \times G_b$  associated with space-time correlates of Jones inclusions. Either  $G_a$  or  $G_b$  would correspond to  $G$ . In the following this mechanism is articulated in a more refined manner by utilizing the general properties of generators of Lie-algebras understood now as a minimal set of elements of algebra from which the entire algebra can be obtained by repeated commutation operator (I have often used "Lie algebra generator" as a synonym for "Lie algebra element"). This set is finite also for Kac-Moody algebras.

#### 1. Two observations

The explanation to be discussed relies on two observations.

1. McKay correspondence for subgroups of  $G$  ( $\mathcal{M} : \mathcal{N} = 4$ ) *resp.* its variants ( $\mathcal{M} : \mathcal{N} < 4$ ) and its counterpart for Jones inclusions means that finite-dimensional irreducible representations of allowed  $G \subset SU(2)$  label both the Cartan algebra generators and the Lie (Kac-Moody) algebra generators of  $t_+$  and  $t_-$  in the decomposition  $g = h \oplus t_+ \oplus t_-$ , where  $h$  is the Lie algebra of maximal compact subgroup.
2. Second observation is related to the generators of Lie-algebras and their quantum counterparts (see Appendix for the explicit formulas for the generators of various algebras considered). The observation is that each Cartan algebra generator of Lie- and quantum group algebras, corresponds to a triplet of generators defining an  $SU(2)$  sub-algebra. The Cartan algebra of affine algebra contains besides Lie group Cartan algebra also a derivation  $d$  identifiable as an infinitesimal scaling operator  $L_0$  measuring the conformal weight of the Kac-Moody generators.  $d$  is exceptional in that it does not give rise to a triplet. It corresponds to the preferred node added to the Dynkin diagram to get the extended Dynkin diagram.

#### 2. Is ADE algebra generated as a quantum deformation of tensor powers of $SU(2)$ Lie algebras representations?

The ADE type symmetry groups could result as an effect of finite quantum resolution described by inclusions of HFFs in TGD inspired quantum measurement theory.

1. The description of finite resolution typically leads to quantization since complex rays of state space are replaced as  $\mathcal{N}$  rays. Hence operators, which would commute for an ideal resolution cease to do so. Therefore the algebra  $SU(2) \otimes \dots \otimes SU(2)$  characterized by  $n$  mutually commuting triplets, where  $n$  is the number of copies of  $SU(2)$  algebra in the original situation and identifiable as quantum algebra appearing in  $\mathcal{M}$  tensor powers with  $\mathcal{M}$  interpreted as  $\mathcal{N}$  module, could suffer quantum deformation to a simple Lie algebra with  $3n$  Cartan algebra generators. Also a deformation to a quantum group could occur as a consequence.

2. This argument makes sense also for discrete groups  $G \subset SU(2)$  since the representations of  $G$  realized in terms of configuration space spinors extend to the representations of  $SU(2)$  naturally.
3. Arbitrarily high tensor powers of  $\mathcal{M}$  are possible and one can wonder why only finite-dimensional Lie algebra results. The fact that  $\mathcal{N}$  has finite depth as a sub-factor means that the tensor products in tensor powers of  $\mathcal{N}$  are representable by a finite Dynkin diagram. Finite depth could thus mean that there is a periodicity involved the  $kn$  tensor powers decomposes to representations of a Lie algebra with  $3n$  Cartan algebra generators. Thus the additional requirement would be that the number of tensor powers of  $\mathcal{M}$  is multiple of  $n$ .

3. *Space-time correlate for the tensor powers  $\mathcal{M} \otimes_{\mathcal{N}} \dots \otimes_{\mathcal{N}} \mathcal{M}$*

By quantum classical correspondence there should exist space-time correlate for the formation of tensor powers of  $\mathcal{M}$  regarded as  $\mathcal{N}$  module. A concrete space-time realization for this kind of situation in TGD would be based on  $n$ -fold cyclic covering of  $H$  implied by the  $H \rightarrow H/G_a \times G_b$  bundle structure in the case of say  $G_b$ . The sheets of the cyclic covering would correspond to various factors in the  $n$ -fold tensor power of  $SU(2)$  and one would obtain a Lie algebra, affine algebra or its quantum counterpart with  $n$  Cartan algebra generators in the process naturally. The number  $n$  for space-time sheets would be also a space-time correlate for the finite depth of  $\mathcal{N}$  as a factor.

Configuration space spinors could provide fermionic representations of  $G \subset SU(2)$ . The Dynkin diagram characterizing tensor products of representations of  $G \subset SU(2)$  with doublet representation suggests that tensor products of doublet representations associated with  $n$  sheets of the covering could realize the Dynkin diagram.

Singlet representation in the Dynkin diagram associated with irreps of  $G$  would not give rise to an  $SU(2)$  sub-algebra in ADE Lie algebra and would correspond to the scaling generator. For ordinary Dynkin diagram representing gauge group algebra scaling operator would be absent and therefore also the exceptional node. Thus the difference between  $(\mathcal{M} : \mathcal{N} = 4)$  and  $(\mathcal{M} : \mathcal{N} < 4)$  cases would be that in the Kac-Moody group would reduce to gauge group  $\mathcal{M} : \mathcal{N} < 4$  because Kac-Moody central charge  $k$  and therefore also Virasoro central charge resulting in Sugawara construction would vanish.

4. *Do finite subgroups of  $SU(2)$  play some role also in  $\mathcal{M} : \mathcal{N} = 4$  case?*

One can ask wonder the possible interpretation for the appearance of extended Dynkin diagrams in  $(\mathcal{M} : \mathcal{N} = 4)$  case. Do finite subgroups  $G \subset SU(2)$  associated with extended Dynkin diagrams appear also in this case. The formal analog for  $H \rightarrow G_a \times G_b$  bundle structure would be  $H \rightarrow H/G_a \times SU(2)$ . This would mean that the geodesic sphere of  $CP_2$  would define the fiber. The notion of number theoretic braid meaning a selection of a discrete subset of algebraic points of the geodesic sphere of  $CP_2$  suggests that  $SU(2)$  actually reduces to its subgroup  $G$  also in this case.

5. *Why Kac-Moody central charge can be non-vanishing only for  $\mathcal{M} : \mathcal{N} = 4$ ?*

From the physical point of view the vanishing of Kac-Moody central charge for  $\mathcal{M} : \mathcal{N} < 4$  is easy to understand. If parton corresponds to a homologically non-trivial geodesic sphere, space-time surface typically represents a string like object so that the generation of Kac-Moody central extension would relate directly to the homological non-triviality of partons. For instance, cosmic strings are string like objects of form  $X^2 \times Y^2$ , where  $X^2$  is minimal surface of  $M^2$  and  $Y^2$  is a holomorphic sub-manifold of  $CP_2$  reducing to a homologically non-trivial geodesic sphere in the simplest situation. A conjecture that deserves to be shown wrong is that central charge  $k$  is proportional/equal to the absolute value of the homology (Kähler magnetic) charge  $h$ .

6. *More general situation*

McKay correspondence generalizes also to the case of subgroups of higher-dimensional Lie groups [?]. The argument above makes sense also for discrete subgroups of more general compact Lie groups  $H$  since also they define unique sub-factors. In this case, algebras having Cartan algebra with  $nk$  generators, where  $n$  is the dimension of Cartan algebra of  $H$ , would emerge in the process. Thus there are reasons to believe that TGD could emulate practically any dynamics having gauge group or Kac-Moody type symmetry. An interesting question concerns the interpretation of non-ADE type principal graphs associated with subgroups of  $SU(2)$ .

7. *Flavor groups of hadron physics as a support for HFF?*

The deformation assigning to an  $n$ -fold tensor power of representations of Lie group  $G$  with  $k$ -dimensional Cartan algebra a representation of a Lie group with  $nk$ -dimensional Cartan algebra could be also seen as a dynamically generated symmetry. If quantum measurement is characterized by the choice of Lie group  $G$  defining measured quantum numbers and defining Jones inclusion characterizing the measurement resolution, the measurement process itself would generate these dynamical symmetries. Interestingly, the flavor symmetry groups of hadron physics cannot be justified from the structure of the standard model having only electro-weak and color group as fundamental symmetries. In TGD framework flavor group  $SU(n)$  could emerge naturally as a fusion of  $n$  quark doublets to form a representation of  $SU(n)$ .

### 15.3.4 Farey sequences, Riemann hypothesis, tangles, and TGD

Farey sequences allow an alternative formulation of Riemann Hypothesis and subsequent pairs in Farey sequence characterize so called rational 2-tangles. In TGD framework Farey sequences relate very closely to dark matter hierarchy, which inspires "*Platonica as the best possible world in the sense that cognitive representations are optimal*" as the basic variational principle of mathematics. This variational principle supports RH.

Possible TGD realizations of tangles, which are considerably more general objects than braids, are considered. One can assign to a given rational tangle a rational number  $a/b$  and the tangles labeled by  $a/b$  and  $c/d$  are equivalent if  $ad - bc = \pm 1$  holds true. This means that the rationals in question are neighboring members of Farey sequence. Very light-hearted guesses about possible generalization of these invariants to the case of general  $N$ -tangles are made.

#### Farey sequences

Some basic facts about Farey sequences [?] demonstrate that they are very interesting also from TGD point of view.

1. Farey sequence  $F_N$  is defined as the set of rationals  $0 \leq q = m/n \leq 1$  satisfying the conditions  $n \leq N$  ordered in an increasing sequence.
2. Two subsequent terms  $a/b$  and  $c/d$  in  $F_N$  satisfy the condition  $ad - bc = 1$  and thus define an element of the modular group  $SL(2, Z)$ .
3. The number  $|F(N)|$  of terms in Farey sequence is given by

$$|F(N)| = |F(N-1)| + \phi(N-1) . \quad (15.3.4)$$

Here  $\phi(n)$  is Euler's totient function giving the number of divisors of  $n$ . For primes one has  $\phi(p) = 1$  so that in the transition from  $p$  to  $p+1$  the length of Farey sequence increases by one unit by the addition of  $q = 1/(p+1)$  to the sequence.

The members of Farey sequence  $F_N$  are in one-one correspondence with the set of quantum phases  $q_n = \exp(i2\pi/n)$ ,  $0 \leq n \leq N$ . This suggests a close connection with the hierarchy of Jones inclusions, quantum groups, and in TGD context with quantum measurement theory with finite measurement resolution and the hierarchy of Planck constants involving the generalization of the imbedding space. Also the recent TGD inspired ideas about the hierarchy of subgroups of the rational modular group with subgroups labeled by integers  $N$  and in direct correspondence with the hierarchy of quantum critical phases [?] would naturally relate to the Farey sequence.

#### Riemann Hypothesis and Farey sequences

Farey sequences are used in two equivalent formulations of the Riemann hypothesis. Suppose the terms of  $F_N$  are  $a_{n,N}$ ,  $0 < n \leq |F_N|$ . Define

$$d_{n,N} = a_{n,N} - \frac{n}{|F_N|} .$$

In other words,  $d_{n,N}$  is the difference between the  $n$ :th term of the  $N$ :th Farey sequence, and the  $n$ :th member of a set of the same number of points, distributed evenly on the unit interval. Franel and Landau proved that both of the following statements

$$\begin{aligned} \sum_{n=1, \dots, |F_N|} |d_{n,N}| &= O(N^r) \text{ for any } r > 1/2 \text{ ,} \\ \sum_{n=1, \dots, |F_N|} d_{n,N}^2 &= O(N^r) \text{ for any } r > 1 \text{ .} \end{aligned} \tag{15.3.5}$$

are equivalent with Riemann hypothesis.

One could say that RH would guarantee that the numbers of Farey sequence provide the best possible approximate representation for the evenly distributed rational numbers  $n/|F_N|$ .

**Farey sequences and TGD**

Farey sequences seem to relate very closely to TGD.

1. The rationals in the Farey sequence can be mapped to the roots of unity by the map  $q \rightarrow \exp(i2\pi q)$ . The numbers  $1/|F_N|$  are in turn mapped to the numbers  $\exp(i2\pi/|F_N|)$ , which are also roots of unity. The statement would be that the algebraic phases defined by Farey sequence give the best possible approximate representation for the phases  $\exp(in2\pi/|F_N|)$  with evenly distributed phase angle.
2. In TGD framework the phase factors defined by  $F_N$  corresponds to the set of quantum phases corresponding to Jones inclusions labeled by  $q = \exp(i2\pi/n)$ ,  $n \leq N$ , and thus to the  $N$  lowest levels of dark matter hierarchy. There are actually two hierarchies corresponding to  $M^4$  and  $CP_2$  degrees of freedom and the Planck constant appearing in Schrödinger equation corresponds to the ratio  $n_a/n_b$  defining quantum phases in these degrees of freedom.  $Z_{n_a \times n_b}$  appears as a conformal symmetry of "dark" partonic 2-surfaces and with very general assumptions this implies that there are only in TGD Universe [?, K16] .
3. The fusion of physics associated with various number fields to single coherent whole requires algebraic universality. In particular, the roots of unity, which are complex algebraic numbers, should define approximations to continuum of phase factors. At least the S-matrix associated with p-adic-to-real transitions and more generally  $p_1 \rightarrow p_2$  transitions between states for which the partonic space-time sheets are  $p_1$ - resp.  $p_2$ -adic can involve only this kind of algebraic phases. One can also say that cognitive representations can involve only algebraic phases and algebraic numbers in general. For real-to-real transitions and real-to-padic transitions U-matrix might be non-algebraic or obtained by analytic continuation of algebraic U-matrix. S-matrix is by definition diagonal with respect to number field and similar continuation principle might apply also in this case.
4. The subgroups of the hierarchy of subgroups of the modular group with rational matrix elements are labeled by integer  $N$  and relate naturally to the hierarchy of Farey sequences. The hierarchy of quantum critical phases is labeled by integers  $N$  with quantum phase transitions occurring only between phases for which the smaller integer divides the larger one [?] .

**Interpretation of RH in TGD framework**

Number theoretic universality of physics suggests an interpretation for the Riemann hypothesis in TGD framework. RH would be equivalent to the statement that the Farey numbers provide best possible approximation to the set of rationals  $k/|F_N|$  or to the statement that the roots of unity contained by  $F_N$  define the best possible approximation for the roots of unity defined as  $\exp(ik2\pi/|F_N|)$  with evenly spaced phase angles. The roots of unity allowed by the lowest  $N$  levels of the dark matter hierarchy allows the best possible approximate representation for algebraic phases represented exactly at  $|F_N|$ :th level of hierarchy.

A stronger statement would be that the Platonica, where RH holds true would be the best possible world in the sense that algebraic physics behind the cognitive representations would allow the best



possible approximation hierarchy for the continuum physics (both for numbers in unit interval and for phases on unit circle). Platonica with RH would be cognitive paradise.

One could see this also from different view point. "Platonica as the cognitively best possible world" could be taken as the "axiom of all axioms": a kind of fundamental variational principle of mathematics. Among other things it would allow to conclude that RH is true: RH must hold true either as a theorem following from some axiomatics or as an axiom in itself.

### Could rational $N$ -tangles exist in some sense?

The article of Kauffman and Lambropoulou [?] about rational 2-tangles having commutative sum and product allowing to map them to rationals is very interesting from TGD point of view. The illustrations of the article are beautiful and make it easy to get the gist of various ideas. The theorem of the article states that equivalent rational tangles giving trivial tangle in the product correspond to subsequent Farey numbers  $a/b$  and  $c/d$  satisfying  $ad - bc = \pm 1$  so that the pair defines element of the modular group  $SL(2, Z)$ .

#### 1. Rational 2-tangles

1. The basic observation is that 2-tangles are 2-tangles in both "s- and t-channels". Product and sum can be defined for all tangles but only in the case of 2-tangles the sum, which in this case reduces to product in t-channel obtained by putting tangles in series, gives 2-tangle. The so called rational tangles are 2-tangles constructible by using addition of  $\pm[1]$  on left or right of tangle and multiplication by  $\pm[1]$  on top or bottom. Product and sum are commutative for rational 2-tangles but the outcome is not a rational 2-tangle in the general case. One can also assign to rational 2-tangle its negative and inverse. One can map 2-tangle to a number which is rational for rational tangles. The tangles  $[0]$ ,  $[\infty]$ ,  $\pm[1]$ ,  $\pm 1/[1]$ ,  $\pm[2]$ ,  $\pm[1/2]$  define so called elementary rational 2-tangles.
2. In the general case the sum of  $M$ - and  $N$ -tangles is  $M + N$  - 2-tangle and combines various  $N$ -tangles to a monoidal structure. Tensor product like operation giving  $M + N$ -tangle looks to me physically more natural than the sum.
3. The reason why general 2-tangles are non-commutative although 2-braids obviously commute is that 2-tangles can be regarded as sequences of  $N$ -tangles with 2-tangles appearing only as the initial and final state:  $N$  is actually even for intermediate states. Since  $N > 2$ -braid groups are non-commutative, non-commutativity results. It would be interesting to know whether braid group representations have been used to construct representations of  $N$ -tangles.

#### 2. Does generalization to $N \gg 2$ case exist?

One can wonder whether the notion of rational tangle and the basic result of the article about equivalence of tangles might somehow generalize to the  $N > 2$  case.

1. Could the commutativity of tangle product allow to characterize the  $N > 2$  generalizations of rational 2-tangles. The commutativity of product would be a space-time correlate for the commutativity of the S-matrices defining time like entanglement between the initial and final quantum states assignable to the  $N$ -tangle. For 2-tangles commutativity of the sum would have an analogous interpretation. Sum is not a very natural operation for  $N$ -tangles for  $N > 2$ . Commutativity means that the representation matrices defined as products of braid group actions associated with the various intermediate states and acting in the same representation space commute. Only in very special cases one can expect commutativity for tangles since commutativity is lost already for braids.
2. The representations of 2-tangles should involve the subgroups of  $N$ -braid groups of intermediate braids identifiable as Galois groups of  $N$ :th order polynomials in the realization as number theoretic tangles. Could non-commutative 2-tangles be characterized by algebraic numbers in the extensions to which the Galois groups are associated? Could the non-commutativity reflect directly the non-commutativity of Galois groups involved? Quite generally one can ask whether the invariants should be expressible using algebraic numbers in the extensions of rationals associated with the intermediate braids.

3. Rational 2-tangles can be characterized by a rational number obtained by a projective identification  $[a, b]^T \rightarrow a/b$  from a rational 2-spinor  $[a, b]^T$  to which  $SL(2(N-1), \mathbb{Z})$  acts. Equivalence means that the columns  $[a, b]^T$  and  $[c, d]^T$  combine to form element of  $SL(2, \mathbb{Z})$  and thus defining a modular transformation. Could more general 2-tangles have a similar representation but in terms of algebraic integers?
4. Could  $N$ -tangles be characterized by  $N - 1$   $2(N - 1)$ -component projective column-spinors  $[a_i^1, a_i^2, \dots, a_i^{2(N-1)}]^T$ ,  $i = 1, \dots, N - 1$  so that only the ratios  $a_i^k/a_i^{2(N-1)} \leq 1$  matter? Could equivalence for them mean that the  $N - 1$  spinors combine to form  $N - 1 + N - 1$  columns of  $SL(2(N - 1), \mathbb{Z})$  matrix. Could  $N$ -tangles quite generally correspond to collections of projective  $N - 1$  spinors having as components algebraic integers and could  $ad - bc = \pm 1$  criterion generalize? Note that the modular group for surfaces of genus  $g$  is  $SL(2g, \mathbb{Z})$  so that  $N - 1$  would be analogous to  $g$  and  $1 \leq N \geq 3$ - braids would correspond to  $g \leq 2$  Riemann surfaces.
5. Dark matter hierarchy leads naturally to a hierarchy of modular sub-groups of  $SL(2, \mathbb{Q})$  labeled by  $N$  (the generator  $\tau \rightarrow \tau + 2$  of modular group is replaced with  $\tau \rightarrow \tau + 2/N$ ). What might be the role of these subgroups and corresponding subgroups of  $SL(2(N - 1), \mathbb{Q})$ . Could they arise in "anyonization" when one considers quantum group representations of 2-tangles with twist operation represented by an  $N$ :th root of unity instead of phase  $U$  satisfying  $U^2 = 1$ ?

### How tangles could be realized in TGD Universe?

The article of Kauffman and Lambropoulou stimulated the question in what senses  $N$ -tangles could be realized in TGD Universe as fundamental structures.

#### 1. Tangles as number theoretic braids?

The strands of number theoretical  $N$ -braids correspond to roots of  $N$ :th order polynomial and if one allows time evolutions of partonic 2-surface leading to the disappearance or appearance of real roots  $N$ -tangles become possible. This however means continuous evolution of roots so that the coefficients of polynomials defining the partonic 2-surface can be rational only in initial and final state but not in all intermediate "virtual" states.

#### 2. Tangles as tangled partonic 2-surfaces?

Tangles could appear in TGD also in second manner.

1. Partonic 2-surfaces are sub-manifolds of a 3-D section of space-time surface. If partonic 2-surfaces have genus  $g > 0$  the handles can become knotted and linked and one obtains besides ordinary knots and links more general knots and links in which circle is replaced by figure eight and its generalizations obtained by adding more circles (eyeglasses for  $N$ -eyed creatures).
2. Since these 2-surfaces are space-like, the resulting structures are indeed tangles rather than only braids. Tangles made of strands with fixed ends would result by allowing spherical partons elongate to long strands with fixed ends. DNA tangles would be the basic example, and are discussed also in the article. DNA sequences to which I have speculatively assigned invisible (dark) braid structures might be seen in this context as space-like "written language representations" of genetic programs represented as number theoretic braids.

### 15.3.5 Only the quantum variants of $M^4$ and $M^8$ emerge from local hyperfinite $II_1$ factors

Super-symmetry suggests that the representations of  $CH$  Clifford algebra  $\mathcal{M}$  as  $\mathcal{N}$  module  $\mathcal{M}/\mathcal{N}$  should have bosonic counterpart in the sense that the coordinate for  $M^8$  representable as a particular  $M^2(Q)$  element should have quantum counterpart. Same would apply to  $M^4$  coordinate representable as  $M^2(C)$  element. Quantum matrix representation of  $\mathcal{M}/\mathcal{N}$  as  $SL_q(2, F)$  matrix,  $F = C, H$  is the natural candidate for this representation. As a matter fact, this guess is not quite correct. It is the interpretation of  $M_2(C)$  as a quaternionic quantum algebra whose generalization to the octonionic quantum algebra works.

Quantum variants of  $M^D$  exist for all dimensions but only spaces  $M^4$  and  $M^8$  and their linear sub-spaces emerge from hyper-finite factors of type  $II_1$ . This is due to the non-associativity of the octonionic representation of the gamma matrices making it impossible to absorb the powers of the octonionic coordinate to the Clifford algebra element so that the local algebra character would disappear. Even more: quantum coordinates for these spaces are commutative operators so that their spectra define ordinary  $M^4$  and  $M^8$  which are thus already quantal concepts.

The commutation relations for  $M_{2,q}(C)$  matrices

$$\begin{pmatrix} a & b \\ c & d \end{pmatrix}, \quad (15.3.6)$$

read as

$$\begin{aligned} ab = qba, \quad ac = qac, \quad bd = qdb, \quad cd = qdc, \\ [ad, da] = (q - q^{-1})bc, \quad bc = cb. \end{aligned} \quad (15.3.7)$$

These relations can be extended by postulating complex conjugates of these relations for complex conjugates  $a^\dagger, b^\dagger, c^\dagger, d^\dagger$  plus the following non-vanishing commutators of type  $[x, y^\dagger]$ :

$$[a, a^\dagger] = [b, b^\dagger] = [c, c^\dagger] = [d, d^\dagger] = 1. \quad (15.3.8)$$

The matrices representing  $M^4$  point must be expressible as sums of Pauli spin matrices. This can be represented as following conditions on physical states

$$\begin{aligned} O|phys\rangle &= 0, \\ O &\in \{a - a^\dagger, d - d^\dagger, b - c^\dagger, c - b^\dagger\}. \end{aligned} \quad (15.3.9)$$

For instance, the first two conditions follow from the reality of Pauli sigma matrices  $\sigma_x, \sigma_y, \sigma_z$ . These conditions are compatible only if the operators  $O$  commute. This is the case and means also that the operators representing  $M^4$  coordinates commute and it is possible to define quantum states for which  $M^4$  coordinates have well-defined eigenvalues so that ordinary  $M^4$  emerges purely quantally from quaternions whose real coefficients are made non-Hermitian operators to obtain operator complexification of quaternions. Also the quantum states in which  $M^4$  coordinates are emerge naturally.

$M_{2,q}(C)$  matrices define the quantum analog of  $C^4$  and one can wonder whether other linear sub-spaces can be defined consistently or whether  $M_q^4$  and thus Minkowski signature is unique. This seems to be the case. For instance, the replacement  $a - \bar{a} \rightarrow a + \bar{a}$  making also time variable Euclidian is impossible since  $[a + \bar{a}, d - \bar{d}] = 2(q - q^{-1})bc$  does not vanish. The observation that  $M^4$  coordinates can be regarded as eigenvalues of commuting observables proves that quantum  $CD$  and its orbifold description are equivalent.

What about  $M^8$ : does it have analogous description? The representation of  $M^4$  point as  $M_2(C)$  matrix can be interpreted a combination of 4-D gamma matrices defining hyper-quaternionic units. Hyper-octonionic units indeed have anticommutation relations of gamma matrices of  $M^8$  and would give classical representation of  $M^8$ . The counterpart of  $M_{2,q}(C)$  would thus be obtained by replacing the coefficients of hyper-octonionic units with operators satisfying the generalization of  $M_{2,q}(C)$  commutation relations. One should identify the reality conditions and find whether they are mutually consistent.

Introduce the coefficients of  $E^4$  gamma matrices having interpretation as quaterionic units as

$$\begin{aligned} a_0 &= ix(a + d), \quad a_3 = x(a - d), \\ a_1 &= x(b + c), \quad a_2 = x(ib - c), \\ x &= \frac{1}{\sqrt{2}}, \end{aligned}$$

and write the commutations relations for them to see how the generalization should be performed.

The selections of commutative and quaternionic sub-algebras of octonion space are fundamental for TGD and quantum octonionic algebra should reflect these selections in its structure. In the case of quaternions the selection of commutative sub-algebra implies the breaking of 4-D Lorentz symmetry. In the case of octonions the selection of quaternion sub-algebra should induce the breaking of 8-D Lorentz symmetry. Quaternionic sub-algebra obeys the commutations of  $M_q(2, C)$  whereas the coefficients in in the complement commute mutually and quantum commute with the complex sub-algebra. This nails down the commutation relations completely:

$$\begin{aligned}
 [a_0, a_3] &= -i(q - q^{-1})(a_1^2 + a_2^2) , \\
 [a_i, a_j] &= 0 , \quad i, j \neq 0, 3 , \\
 a_0 a_i &= q a_i a_0 , \quad i \neq 0, 3 , \\
 a_3 a_i &= q a_i a_3 , \quad i \neq 0, 3 .
 \end{aligned} \tag{15.3.10}$$

Checking that  $M^8$  indeed corresponds to commutative subspace defined by the eigenvalues of operators is straightforward.

The argument generalizes easily to other dimensions  $D \geq 4$  but now quaternionic and octonionic units must be replaced by gamma matrices and an explicit matrix representation can be introduced. These gamma matrices can be included as a tensor factor to the infinite-dimensional Clifford algebra so that the local Clifford algebra reduces to a mere Clifford algebra. The units of quantum octonions which are just ordinary octonion units do not however allow matrix representation so that this reduction is not possible and imbedding space and space-time indeed emerge genuinely. The non-associativity of octonions would determine the laws of physics in TGD Universe!

Thus the special role of classical number fields and uniqueness of space-time and imbedding space dimensions becomes really manifest only when a quantal deformation of the quaternionic and octonionic matrix algebras is performed. It is possible to construct the quantal variants of the coset spaces  $M^4 \times E^4 / G_a \times G_b$  by simply posing restrictions on the of eigen states of the commuting coordinate operators. Also the quantum variants of the space-time surface and quite generally, manifolds obtained from linear spaces by geometric constructions become possible.

# Mathematics

- [A1] Gaussian Mersenne. <http://primes.utm.edu/glossary/xpage/GaussianMersenne.html>.
- [A2] Z. I. Borevich and I. R. Shafarevich. *Number Theory*. Academic Press, 1966.
- [A3] Eisenhart. *Riemannian Geometry*. Princeton University Press, 1964.
- [A4] C. N. Pope G. W. Gibbons.  $CP_2$  as gravitational instanton. *Comm. Math. Phys.*, 55, 1977.
- [A5] W. Hawking, S. and N. Pope, C. Generalized Spin Structures in Quantum Gravity. *Phys. Lett.*, (1), 1978.
- [A6] S. Helgason. *Differential Geometry and Symmetric Spaces*. Academic Press, New York, 1962.
- [A7] C. Itzykson and J-B. Zuber. *Quantum Field Theory*, volume 549. Mc Graw-Hill, New York, 1980.
- [A8] J. Milnor. *Topology form Differential Point of View*. The University Press of Virginia, Virginia, 1965.
- [A9] D. S. Moak. The q-analogue of the Laguerre polynomials. *J. Math. Anal. Appl.*, 81, 1981.
- [A10] N. Pope, C. Eigenfunctions and  $Spin^c$  Structures on  $CP_2$ , 1980.
- [A11] B. Shipman. The geometry of momentum mappings on generalized flag manifolds, connections with a dynamical system, quantum mechanics and the dance of honeybee. <http://math.cornell.edu/~oliver/Shipman.gif>, 1998.
- [A12] M. Spivak. *Differential Geometry I,II,III,IV*. Publish or Perish, Boston, 1970.
- [A13] J. Hanson T. Eguchi, B. Gilkey. *Phys. Rep.*, 66:1980, 1980.
- [A14] R. Thom. *Commentarii Math. Helvet.*, 28, 1954.
- [A15] Wallace. *Differential Topology*. W. A. Benjamin, New York, 1968.
- [A16] E. C. Zeeman. *Catastrophe Theory*. Addison-Wessley Publishing Company, 1977.



# Theoretical Physics

- [B1] J. Björken and S. Drell. *Relativistic Quantum Fields*. Mc Graw-Hill, New York, 1965.
- [B2] K. Huang. *Quarks, Leptons & Gauge Fields*. World Scientific, 1982.
- [B3] R. Kiehn. Electromagnetic waves in vacuum with torsion and spin. <http://www22.pair.com/csdc/pdf/helical6.pdf>.
- [B4] G. Parisi. *Field Theory, Disorder and Simulations*. World Scientific, 1992.
- [B5] A. Zee. *The Unity of Forces in the Universe*. World Science Press, Singapore, 1982.





# Cosmology and Astro-Physics

- [E1] Age of the universe. [http://en.wikipedia.org/wiki/Age\\_of\\_the\\_universe](http://en.wikipedia.org/wiki/Age_of_the_universe).
- [E2] Allais effect. [http://en.wikipedia.org/wiki/Allais\\_effect](http://en.wikipedia.org/wiki/Allais_effect).
- [E3] Cavendish experiment. [http://en.wikipedia.org/wiki/Cavendish\\_experiment](http://en.wikipedia.org/wiki/Cavendish_experiment).
- [E4] French Nobel Laureate turns back clock. [http://science.nasa.gov/newhome/headlines/ast12oct99\\_1.htm](http://science.nasa.gov/newhome/headlines/ast12oct99_1.htm).
- [E5] French Nobel Laureate turns back clock: Marshall's global experiment, von Braun memories evoked during August 11 solar eclipse. [http://science.nasa.gov/newhome/headlines/ast12oct99\\_1.htm](http://science.nasa.gov/newhome/headlines/ast12oct99_1.htm).
- [E6] Rings of Saturn. [http://en.wikipedia.org/wiki/Rings\\_of\\_Saturn](http://en.wikipedia.org/wiki/Rings_of_Saturn).
- [E7] Saturn. <http://en.wikipedia.org/wiki/Saturn>.
- [E8] Saturnus. <http://en.wikipedia.org/wiki/Saturn>.
- [E9] M. Allais. Should the Laws of Gravitation be modified?: Part I -Abnormalities in the Motion of a Paraconical Pendulum with Anisotropic Support. *Aero/Space Engineering*, 1959, 1959.
- [E10] M. Allais. Should the Laws of Gravitation be modified?: Part II -Experiments in Connection with the Abnomralities the Motion of a Paraconical Pendulum with an Isotropic Support. *Aero/Space Engineering*, October 1959.
- [E11] M. Allais. Should the Laws of Gravitation Be Reconsidered: Part I,II,III? <http://home.t01.itscom.net/allais/blackprior/allais/lawgravit/lawgrav-one.pdf>, 1959.
- [E12] C. Charbonnel and F. Primas. The lithium content of the Galactic Halo stars. <http://arxiv.org/abs/astro-ph/0505247>, 2005.
- [E13] A. E. Nelson E. G. Adelberger, B. R. Heckel. Tests of Gravitational Inverse-Square Law. <http://www.npl.washington.edu/eotwash/pdf/review.pdf>, 2005.
- [E14] J. A. Eddy and A. A. Boornazian. Secular decrease in the solar diameter. *Bulletin of the American Astronomical Society*, 11(437):1863–1953, 1979.
- [E15] I. Mihaila et al. A new confirmation of the Allais effect during the solar eclipse of 31 2003 May. <http://home.t01.itscom.net/allais/blackprior/mihaila/2003/mihaila2003.pdf>, 2003.
- [E16] Qian-Shen Wang et al. Precise measurement of gravity variations during a total solar eclipse. *Phys. Rev. D*. <http://home.t01.itscom.net/allais/blackprior/wang/wangetal.pdf>, 62, 2000.
- [E17] S. E. Shnoll et al. Realization of discrete fluctuations in macroscopic processes. *Physics-Uspeski*. <http://home.t01.itscom.net/allais/blackprior/shnoll/shnoll-1.pdf>, 41(10):1025–1035, 1998.
- [E18] G. I. Rusu G. T. Jeverdan and V. Antonescu. Experiments using the Foucault pendulum during the solar eclipse of 15 February, 1961. *Biblical Astronomer*, 1(55), 1981.

- [E19] G. T. Gilles. *American J. of Physics*, 58, 1990.
- [E20] R. L. Gilliland. Solar radius variations over the past 265 years. *Astrophysical Journal*, 248:1155, 1981.
- [E21] Gia Dvali Nima Arkani-Hamed, Savas Dimopoulos. The Hierarchy Problem and New Dimensions at a Millimeter. <http://arxiv.org/abs/hep-ph/9803315>, 1998.
- [E22] M. Holman R. Malhotra and T. Ito. Chaos and stability of the solar system. *Proc. Natl. Acad. Sci. USA*. <http://www.pubmedcentral.nih.gov/articlerender.fcgi?artid=60054>, 98:12342–12343, October 2001.
- [E23] D. Da Roacha and L. Nottale. Gravitational Structure Formation in Scale Relativity. <http://arxiv.org/abs/astro-ph/0310036>, 2003.
- [E24] R. N. Tran U. E. Kruse. Cavendish experiment. <http://www.ccsr.uiuc.edu/~alfred/Ph101/Notes.htm/cavendish/index.html>, 1995.
- [E25] D. Olenici V. A. Popescu. A confirmation of the Allais and Jeverdan-Rusu-Antonescu effects during the solar eclipse from 22 September 2006, and the quantization behavior of pendulum. <http://www.hessdalen.org/sse/program/Articol.pdf>, 2007.

# Books related to TGD

- [K1] M. Pitkänen. 1983.
- [K2] M. Pitkänen. Is it Possible to Understand Coupling Constant Evolution at Space-Time Level? In *Towards M-Matrix*. Onlinebook. [http://tgdtheory.com/public\\_html/tgdquant/tgdquant.html#rgflow](http://tgdtheory.com/public_html/tgdquant/tgdquant.html#rgflow), 2006.
- [K3] M. Pitkänen. About Strange Effects Related to Rotating Magnetic Systems . In *TGD and Fringe Physics*. Onlinebook. [http://tgdtheory.com/public\\_html/freenergy/freenergy.html#Faraday](http://tgdtheory.com/public_html/freenergy/freenergy.html#Faraday), 2006.
- [K4] M. Pitkänen. About the New Physics Behind Qualia. In *Quantum Hardware of Living Matter*. Onlinebook. [http://tgdtheory.com/public\\_html/bioware/bioware.html#newphys](http://tgdtheory.com/public_html/bioware/bioware.html#newphys), 2006.
- [K5] M. Pitkänen. An Overview about Quantum TGD: Part I. In *Topological Geometrodynamics: Overview*. Onlinebook. [http://tgdtheory.com/public\\_html/tgdview/tgdview.html#evoII](http://tgdtheory.com/public_html/tgdview/tgdview.html#evoII), 2006.
- [K6] M. Pitkänen. An Overview about the Evolution of Quantum TGD. In *Topological Geometrodynamics: Overview*. Onlinebook. [http://tgdtheory.com/public\\_html/tgdview/tgdview.html#evoI](http://tgdtheory.com/public_html/tgdview/tgdview.html#evoI), 2006.
- [K7] M. Pitkänen. Anomalies Related to the Classical  $Z^0$  Force and Gravitation. In *TGD and Fringe Physics*. Onlinebook. [http://tgdtheory.com/public\\_html/freenergy/freenergy.html#Zanom](http://tgdtheory.com/public_html/freenergy/freenergy.html#Zanom), 2006.
- [K8] M. Pitkänen. Appendix A: Quantum Groups and Related Structures. In *Towards M-Matrix*. Onlinebook. [http://tgdtheory.com/public\\_html/tgdquant/tgdquant.html#bialgebra](http://tgdtheory.com/public_html/tgdquant/tgdquant.html#bialgebra), 2006.
- [K9] M. Pitkänen. Basic Extremals of Kähler Action. In *Physics in Many-Sheeted Space-Time*. Onlinebook. [http://tgdtheory.com/public\\_html/tgdclass/tgdclass.html#class](http://tgdtheory.com/public_html/tgdclass/tgdclass.html#class), 2006.
- [K10] M. Pitkänen. *Bio-Systems as Conscious Holograms*. Onlinebook. [http://tgdtheory.com/public\\_html/hologram/hologram.html](http://tgdtheory.com/public_html/hologram/hologram.html), 2006.
- [K11] M. Pitkänen. Bio-Systems as Conscious Holograms. In *Bio-Systems as Conscious Holograms*. Onlinebook. [http://tgdtheory.com/public\\_html/hologram/hologram.html#hologram](http://tgdtheory.com/public_html/hologram/hologram.html#hologram), 2006.
- [K12] M. Pitkänen. *Bio-Systems as Self-Organizing Quantum Systems*. Onlinebook. [http://tgdtheory.com/public\\_html/bioselforg/bioselforg.html](http://tgdtheory.com/public_html/bioselforg/bioselforg.html), 2006.
- [K13] M. Pitkänen. Bio-Systems as Super-Conductors: part I. In *Quantum Hardware of Living Matter*. Onlinebook. [http://tgdtheory.com/public\\_html/bioware/bioware.html#superc1](http://tgdtheory.com/public_html/bioware/bioware.html#superc1), 2006.
- [K14] M. Pitkänen. Bio-Systems as Super-Conductors: part II. In *Quantum Hardware of Living Matter*. Onlinebook. [http://tgdtheory.com/public\\_html/bioware/bioware.html#superc2](http://tgdtheory.com/public_html/bioware/bioware.html#superc2), 2006.
- [K15] M. Pitkänen. Configuration Space Spinor Structure. In *Quantum Physics as Infinite-Dimensional Geometry*. Onlinebook. [http://tgdtheory.com/public\\_html/tgdgeom/tgdgeom.html#cspin](http://tgdtheory.com/public_html/tgdgeom/tgdgeom.html#cspin), 2006.

- [K16] M. Pitkänen. Construction of elementary particle vacuum functionals. In *p-Adic Length Scale Hypothesis and Dark Matter Hierarchy*. Onlinebook. [http://tgdtheory.com/public\\_html/paddark/paddark.html#elvafu](http://tgdtheory.com/public_html/paddark/paddark.html#elvafu), 2006.
- [K17] M. Pitkänen. Construction of Quantum Theory: M-matrix. In *Towards M-Matrix*. Onlinebook. [http://tgdtheory.com/public\\_html/tgdquant/tgdquant.html#towards](http://tgdtheory.com/public_html/tgdquant/tgdquant.html#towards), 2006.
- [K18] M. Pitkänen. Cosmic Strings. In *Physics in Many-Sheeted Space-Time*. Onlinebook. [http://tgdtheory.com/public\\_html/tgdclass/tgdclass.html#cstrings](http://tgdtheory.com/public_html/tgdclass/tgdclass.html#cstrings), 2006.
- [K19] M. Pitkänen. Crop Circles and Life at Parallel Space-Time Sheets. In *Magnetospheric Consciousness*. Onlinebook. [http://tgdtheory.com/public\\_html/magnconsc/magnconsc.html#crop1](http://tgdtheory.com/public_html/magnconsc/magnconsc.html#crop1), 2006.
- [K20] M. Pitkänen. Crop Circles and Life at Parallel Space-Time Sheets. In *Magnetospheric Consciousness*. Onlinebook. [http://tgdtheory.com/public\\_html/magnconsc/magnconsc.html#crop2](http://tgdtheory.com/public_html/magnconsc/magnconsc.html#crop2), 2006.
- [K21] M. Pitkänen. Dark Forces and Living Matter. In *p-Adic Length Scale Hypothesis and Dark Matter Hierarchy*. Onlinebook. [http://tgdtheory.com/public\\_html/paddark/paddark.html#darkforces](http://tgdtheory.com/public_html/paddark/paddark.html#darkforces), 2006.
- [K22] M. Pitkänen. Dark Matter Hierarchy and Hierarchy of EEGs. In *TGD and EEG*. Onlinebook. [http://tgdtheory.com/public\\_html/tgdeeg/tgdeeg.html#eegdark](http://tgdtheory.com/public_html/tgdeeg/tgdeeg.html#eegdark), 2006.
- [K23] M. Pitkänen. Dark Nuclear Physics and Condensed Matter. In *p-Adic Length Scale Hypothesis and Dark Matter Hierarchy*. Onlinebook. [http://tgdtheory.com/public\\_html/paddark/paddark.html#exonuclear](http://tgdtheory.com/public_html/paddark/paddark.html#exonuclear), 2006.
- [K24] M. Pitkänen. DNA as Topological Quantum Computer. In *Genes and Memes*. Onlinebook. [http://tgdtheory.com/public\\_html/genememe/genememe.html#dnatqc](http://tgdtheory.com/public_html/genememe/genememe.html#dnatqc), 2006.
- [K25] M. Pitkänen. Does TGD Predict the Spectrum of Planck Constants? In *Towards M-Matrix*. Onlinebook. [http://tgdtheory.com/public\\_html/tgdquant/tgdquant.html#Planck](http://tgdtheory.com/public_html/tgdquant/tgdquant.html#Planck), 2006.
- [K26] M. Pitkänen. Evolution in Many-Sheeted Space-Time. In *Genes and Memes*. Onlinebook. [http://tgdtheory.com/public\\_html/genememe/genememe.html#prebio](http://tgdtheory.com/public_html/genememe/genememe.html#prebio), 2006.
- [K27] M. Pitkänen. General Ideas about Many-Sheeted Space-Time: Part I. In *Physics in Many-Sheeted Space-Time*. Onlinebook. [http://tgdtheory.com/public\\_html/tgdclass/tgdclass.html#topcond](http://tgdtheory.com/public_html/tgdclass/tgdclass.html#topcond), 2006.
- [K28] M. Pitkänen. General Theory of Qualia. In *Bio-Systems as Conscious Holograms*. Onlinebook. [http://tgdtheory.com/public\\_html/hologram/hologram.html#qualia](http://tgdtheory.com/public_html/hologram/hologram.html#qualia), 2006.
- [K29] M. Pitkänen. *Genes and Memes*. Onlinebook. [http://tgdtheory.com/public\\_html/genememe/genememe.html](http://tgdtheory.com/public_html/genememe/genememe.html), 2006.
- [K30] M. Pitkänen. Genes and Memes. In *Genes and Memes*. Onlinebook. [http://tgdtheory.com/public\\_html/genememe/genememe.html#genememec](http://tgdtheory.com/public_html/genememe/genememe.html#genememec), 2006.
- [K31] M. Pitkänen. Homeopathy in Many-Sheeted Space-Time. In *Bio-Systems as Conscious Holograms*. Onlinebook. [http://tgdtheory.com/public\\_html/hologram/hologram.html#homeoc](http://tgdtheory.com/public_html/hologram/hologram.html#homeoc), 2006.
- [K32] M. Pitkänen. Macro-Temporal Quantum Coherence and Spin Glass Degeneracy. In *Bio-Systems as Conscious Holograms*. Onlinebook. [http://tgdtheory.com/public\\_html/hologram/hologram.html#macro](http://tgdtheory.com/public_html/hologram/hologram.html#macro), 2006.
- [K33] M. Pitkänen. Macroscopic Quantum Coherence and Quantum Metabolism as Different Sides of the Same Coin. In *Bio-Systems as Conscious Holograms*. Onlinebook. [http://tgdtheory.com/public\\_html/hologram/hologram.html#metab](http://tgdtheory.com/public_html/hologram/hologram.html#metab), 2006.

- [K34] M. Pitkänen. Macroscopic Quantum Phenomena and  $CP_2$  Geometry. In *Physics in Many-Sheeted Space-Time*. Onlinebook. [http://tgdtheory.com/public\\_html/tgdclass/tgdclass.html#super](http://tgdtheory.com/public_html/tgdclass/tgdclass.html#super), 2006.
- [K35] M. Pitkänen. Magnetic Sensory Canvas Hypothesis. In *TGD and EEG*. Onlinebook. [http://tgdtheory.com/public\\_html//tgdeeg/tgdeeg/tgdeeg.html#mec](http://tgdtheory.com/public_html//tgdeeg/tgdeeg/tgdeeg.html#mec), 2006.
- [K36] M. Pitkänen. *Magnetospheric Consciousness*. Onlinebook. [http://tgdtheory.com/public\\_html/magnconsc/magnconsc.html](http://tgdtheory.com/public_html/magnconsc/magnconsc.html), 2006.
- [K37] M. Pitkänen. Magnetospheric Sensory Representations. In *Magnetospheric Consciousness*. Onlinebook. [http://tgdtheory.com/public\\_html/magnconsc/magnconsc.html#srepre](http://tgdtheory.com/public_html/magnconsc/magnconsc.html#srepre), 2006.
- [K38] M. Pitkänen. Many-Sheeted DNA. In *Genes and Memes*. Onlinebook. [http://tgdtheory.com/public\\_html/genememe/genememe.html#genecodec](http://tgdtheory.com/public_html/genememe/genememe.html#genecodec), 2006.
- [K39] M. Pitkänen. Massless states and particle massivation. In *p-Adic Length Scale Hypothesis and Dark Matter Hierarchy*. Onlinebook. [http://tgdtheory.com/public\\_html/paddark/paddark.html#mless](http://tgdtheory.com/public_html/paddark/paddark.html#mless), 2006.
- [K40] M. Pitkänen. *Mathematical Aspects of Consciousness Theory*. Onlinebook. [http://tgdtheory.com/public\\_html/mathconsc/mathconsc.html](http://tgdtheory.com/public_html/mathconsc/mathconsc.html), 2006.
- [K41] M. Pitkänen. Matter, Mind, Quantum. In *TGD Inspired Theory of Consciousness*. Onlinebook. [http://tgdtheory.com/public\\_html/tgdconsc/tgdconsc.html#conscic](http://tgdtheory.com/public_html/tgdconsc/tgdconsc.html#conscic), 2006.
- [K42] M. Pitkänen. Negentropy Maximization Principle. In *TGD Inspired Theory of Consciousness*. Onlinebook. [http://tgdtheory.com/public\\_html/tgdconsc/tgdconsc.html#nmpc](http://tgdtheory.com/public_html/tgdconsc/tgdconsc.html#nmpc), 2006.
- [K43] M. Pitkänen. New Particle Physics Predicted by TGD: Part I. In *p-Adic Length Scale Hypothesis and Dark Matter Hierarchy*. Onlinebook. [http://tgdtheory.com/public\\_html/paddark/paddark.html#mass4](http://tgdtheory.com/public_html/paddark/paddark.html#mass4), 2006.
- [K44] M. Pitkänen. Nuclear String Hypothesis. In *p-Adic Length Scale Hypothesis and Dark Matter Hierarchy*. Onlinebook. [http://tgdtheory.com/public\\_html/paddark/paddark.html#nuclstring](http://tgdtheory.com/public_html/paddark/paddark.html#nuclstring), 2006.
- [K45] M. Pitkänen. *p-Adic length Scale Hypothesis and Dark Matter Hierarchy*. Onlinebook. [http://tgdtheory.com/public\\_html/paddark/paddark.html](http://tgdtheory.com/public_html/paddark/paddark.html), 2006.
- [K46] M. Pitkänen. p-Adic Particle Massivation: Hadron Masses. In *p-Adic Length Scale Hypothesis and Dark Matter Hierarchy*. Onlinebook. [http://tgdtheory.com/public\\_html/paddark/paddark.html#mass3](http://tgdtheory.com/public_html/paddark/paddark.html#mass3), 2006.
- [K47] M. Pitkänen. p-Adic Physics as Physics of Cognition and Intention. In *TGD Inspired Theory of Consciousness*. Onlinebook. [http://tgdtheory.com/public\\_html/tgdconsc/tgdconsc.html#cognic](http://tgdtheory.com/public_html/tgdconsc/tgdconsc.html#cognic), 2006.
- [K48] M. Pitkänen. *Physics in Many-Sheeted Space-Time*. Onlinebook. [http://tgdtheory.com/public\\_html/tgdclass/tgdclass.html](http://tgdtheory.com/public_html/tgdclass/tgdclass.html), 2006.
- [K49] M. Pitkänen. Quantum Antenna Hypothesis. In *Quantum Hardware of Living Matter*. Onlinebook. [http://tgdtheory.com/public\\_html/bioware/bioware.html#tubuc](http://tgdtheory.com/public_html/bioware/bioware.html#tubuc), 2006.
- [K50] M. Pitkänen. Quantum Astrophysics. In *Physics in Many-Sheeted Space-Time*. Onlinebook. [http://tgdtheory.com/public\\_html/tgdclass/tgdclass.html#qastro](http://tgdtheory.com/public_html/tgdclass/tgdclass.html#qastro), 2006.
- [K51] M. Pitkänen. Quantum Control and Coordination in Bio-systems: Part I. In *Bio-Systems as Self-Organizing Quantum Systems*. Onlinebook. [http://tgdtheory.com/public\\_html/bioselforg/bioselforg.html#qcococI](http://tgdtheory.com/public_html/bioselforg/bioselforg.html#qcococI), 2006.
- [K52] M. Pitkänen. Quantum Control and Coordination in Bio-Systems: Part II. In *Bio-Systems as Self-Organizing Quantum Systems*. Onlinebook. [http://tgdtheory.com/public\\_html/bioselforg/bioselforg.html#qcococII](http://tgdtheory.com/public_html/bioselforg/bioselforg.html#qcococII), 2006.

- [K53] M. Pitkänen. *Quantum Hardware of Living Matter*. Onlinebook. [http://tgdtheory.com/public\\_html/bioware/bioware.html](http://tgdtheory.com/public_html/bioware/bioware.html), 2006.
- [K54] M. Pitkänen. Quantum Model for Hearing. In *TGD and EEG*. Onlinebook. [http://tgdtheory.com/public\\_html//tgdeeg/tgdeeg/tgdeeg.html#hearing](http://tgdtheory.com/public_html//tgdeeg/tgdeeg/tgdeeg.html#hearing), 2006.
- [K55] M. Pitkänen. Quantum Model for Nerve Pulse. In *TGD and EEG*. Onlinebook. [http://tgdtheory.com/public\\_html//tgdeeg/tgdeeg/tgdeeg.html#pulse](http://tgdtheory.com/public_html//tgdeeg/tgdeeg/tgdeeg.html#pulse), 2006.
- [K56] M. Pitkänen. Quantum Model for Paranormal Phenomena. In *TGD Inspired Theory of Consciousness*. Onlinebook. [http://tgdtheory.com/public\\_html/tgdconsc/tgdconsc.html#parac](http://tgdtheory.com/public_html/tgdconsc/tgdconsc.html#parac), 2006.
- [K57] M. Pitkänen. Quantum Model for Sensory Representations. In *TGD Inspired Theory of Consciousness*. Onlinebook. [http://tgdtheory.com/public\\_html/tgdconsc/tgdconsc.html#expc](http://tgdtheory.com/public_html/tgdconsc/tgdconsc.html#expc), 2006.
- [K58] M. Pitkänen. Quantum Model of EEG. In *TGD and EEG*. Onlinebook. [http://tgdtheory.com/public\\_html/tgdeeg/tgdeeg.html#eegII](http://tgdtheory.com/public_html/tgdeeg/tgdeeg.html#eegII), 2006.
- [K59] M. Pitkänen. Quantum Model of Memory. In *TGD Inspired Theory of Consciousness*. Onlinebook. [http://tgdtheory.com/public\\_html/tgdconsc/tgdconsc.html#memoryc](http://tgdtheory.com/public_html/tgdconsc/tgdconsc.html#memoryc), 2006.
- [K60] M. Pitkänen. *Quantum Physics as Infinite-Dimensional Geometry*. Onlinebook. [http://tgdtheory.com/public\\_html/tgdgeom/tgdgeom.html](http://tgdtheory.com/public_html/tgdgeom/tgdgeom.html), 2006.
- [K61] M. Pitkänen. *Quantum TGD*. Onlinebook. [http://tgdtheory.com/public\\_html/tgdquant/tgdquant.html](http://tgdtheory.com/public_html/tgdquant/tgdquant.html), 2006.
- [K62] M. Pitkänen. Quantum Theory of Self-Organization. In *Bio-Systems as Self-Organizing Quantum Systems*. Onlinebook. [http://tgdtheory.com/public\\_html/bioselforg/bioselforg.html#selforgac](http://tgdtheory.com/public_html/bioselforg/bioselforg.html#selforgac), 2006.
- [K63] M. Pitkänen. Semi-trance, Mental Illness, and Altered States of Consciousness. In *Magnetospheric Consciousness*. Onlinebook. [http://tgdtheory.com/public\\_html/magnconsc/magnconsc.html#semitrancec](http://tgdtheory.com/public_html/magnconsc/magnconsc.html#semitrancec), 2006.
- [K64] M. Pitkänen. Semitrance, Language, and Development of Civilization. In *Magnetospheric Consciousness*. Onlinebook. [http://tgdtheory.com/public\\_html/magnconsc/magnconsc.html#langsoc](http://tgdtheory.com/public_html/magnconsc/magnconsc.html#langsoc), 2006.
- [K65] M. Pitkänen. TGD and Astrophysics. In *Physics in Many-Sheeted Space-Time*. Onlinebook. [http://tgdtheory.com/public\\_html/tgdclass/tgdclass.html#astro](http://tgdtheory.com/public_html/tgdclass/tgdclass.html#astro), 2006.
- [K66] M. Pitkänen. TGD and Cosmology. In *Physics in Many-Sheeted Space-Time*. Onlinebook. [http://tgdtheory.com/public\\_html/tgdclass/tgdclass.html#cosmo](http://tgdtheory.com/public_html/tgdclass/tgdclass.html#cosmo), 2006.
- [K67] M. Pitkänen. *TGD and EEG*. Onlinebook. [http://tgdtheory.com/public\\_html/tgdeeg/tgdeeg.html](http://tgdtheory.com/public_html/tgdeeg/tgdeeg.html), 2006.
- [K68] M. Pitkänen. *TGD and Fringe Physics*. Onlinebook. [http://tgdtheory.com/public\\_html/freenergy/freenergy.html](http://tgdtheory.com/public_html/freenergy/freenergy.html), 2006.
- [K69] M. Pitkänen. TGD and Nuclear Physics. In *p-Adic Length Scale Hypothesis and Dark Matter Hierarchy*. Onlinebook. [http://tgdtheory.com/public\\_html/paddark/paddark.html#padnucl](http://tgdtheory.com/public_html/paddark/paddark.html#padnucl), 2006.
- [K70] M. Pitkänen. *TGD as a Generalized Number Theory*. Onlinebook. [http://tgdtheory.com/public\\_html/tgdnumber/tgdnumber.html](http://tgdtheory.com/public_html/tgdnumber/tgdnumber.html), 2006.
- [K71] M. Pitkänen. TGD as a Generalized Number Theory: p-Adicization Program. In *TGD as a Generalized Number Theory*. Onlinebook. [http://tgdtheory.com/public\\_html/tgdnumber/tgdnumber.html#visiona](http://tgdtheory.com/public_html/tgdnumber/tgdnumber.html#visiona), 2006.

- [K72] M. Pitkänen. TGD as a Generalized Number Theory: Quaternions, Octonions, and their Hyper Counterparts. In *TGD as a Generalized Number Theory*. Onlinebook. [http://tgdtheory.com/public\\_html/tgdnumber/tgdnumber.html#visionb](http://tgdtheory.com/public_html/tgdnumber/tgdnumber.html#visionb), 2006.
- [K73] M. Pitkänen. TGD Based Model for OBEs. In *TGD Inspired Theory of Consciousness*. Onlinebook. [http://tgdtheory.com/public\\_html/tgdconsc/tgdconsc.html#OBE](http://tgdtheory.com/public_html/tgdconsc/tgdconsc.html#OBE), 2006.
- [K74] M. Pitkänen. *TGD Inspired Theory of Consciousness*. Onlinebook. [http://tgdtheory.com/public\\_html/tgdconsc/tgdconsc.html](http://tgdtheory.com/public_html/tgdconsc/tgdconsc.html), 2006.
- [K75] M. Pitkänen. TGD Inspired Theory of Consciousness. In *Topological Geometrodynamics: Overview*. Onlinebook. [http://tgdtheory.com/public\\_html/tgdview/tgdview.html#tgdconsc2010](http://tgdtheory.com/public_html/tgdview/tgdview.html#tgdconsc2010), 2006.
- [K76] M. Pitkänen. The Notion of Free Energy and Many-Sheeted Space-Time Concept. In *TGD and Fringe Physics*. Onlinebook. [http://tgdtheory.com/public\\_html/freenergy/freenergy.html#freenergy](http://tgdtheory.com/public_html/freenergy/freenergy.html#freenergy), 2006.
- [K77] M. Pitkänen. The Relationship Between TGD and GRT. In *Physics in Many-Sheeted Space-Time*. Onlinebook. [http://tgdtheory.com/public\\_html/tgdclass/tgdclass.html#tgdgrt](http://tgdtheory.com/public_html/tgdclass/tgdclass.html#tgdgrt), 2006.
- [K78] M. Pitkänen. Three new physics realizations of the genetic code and the role of dark matter in bio-systems. In *Genes and Memes*. Onlinebook. [http://tgdtheory.com/public\\_html/genememe/genememe.html#dnatqccodes](http://tgdtheory.com/public_html/genememe/genememe.html#dnatqccodes), 2006.
- [K79] M. Pitkänen. Time, Spacetime and Consciousness. In *Bio-Systems as Conscious Holograms*. Onlinebook. [http://tgdtheory.com/public\\_html/hologram/hologram.html#time](http://tgdtheory.com/public_html/hologram/hologram.html#time), 2006.
- [K80] M. Pitkänen. *Topological Geometrodynamics: an Overview*. Onlinebook. [http://tgdtheory.com/public\\_html/tgdview/tgdview.html](http://tgdtheory.com/public_html/tgdview/tgdview.html), 2006.
- [K81] M. Pitkänen. Topological Quantum Computation in TGD Universe. In *Genes and Memes*. Onlinebook. [http://tgdtheory.com/public\\_html/genememe/genememe.html#tqc](http://tgdtheory.com/public_html/genememe/genememe.html#tqc), 2006.
- [K82] M. Pitkänen. Was von Neumann Right After All. In *Towards M-Matrix*. Onlinebook. [http://tgdtheory.com/public\\_html/tgdquant/tgdquant.html#vNeumann](http://tgdtheory.com/public_html/tgdquant/tgdquant.html#vNeumann), 2006.
- [K83] M. Pitkänen. Wormhole Magnetic Fields. In *Quantum Hardware of Living Matter*. Onlinebook. [http://tgdtheory.com/public\\_html/bioware/bioware.html#wormc](http://tgdtheory.com/public_html/bioware/bioware.html#wormc), 2006.





# Chapter 1

## Appendix

### A-1 Introduction

In its original form this chapter contained brave speculations about the equivalence of loop diagrams with tree diagrams proposed to generalize the duality of hadronic string models. It however turned out that this picture has no obvious connection with the generalized Feynman diagrams- a notion which emerged years later. Since the physical interpretation and mathematical framework of quantum TGD has now reached relatively mature and stable state, I decided that it is time to drop out these speculations and leave only the hard mathematical facts as appendix possibly useful also for the reader.

### A-2 Hopf algebras and ribbon categories as basic structures

In this section the basic notions related to Hopf algebras and categories are discussed from TGD point of view. Examples are left to appendix. The new element is the graphical representation of the axioms leading to the idea about the equivalent of loop diagrams and tree diagrams based on general algebraic axioms.

#### A-2.1 Hopf algebras and ribbon categories very briefly

An algebraic formulation generalizing braided Hopf algebras and related structures to what might be called quantum category would involve the replacement of the co-product of Hopf algebras with morphism of quantum category having as its objects the Clifford algebras associated with configuration space spinor structure for various 3-topologies. The corresponding Fock spaces would define algebra modules and the objects of the category would consist of pairs of algebras and corresponding modules. The underlying primary structure would be second quantized free induced spinor fields associated with 3-surfaces with various 3-topologies and generalized conformal structures.

##### 1. Bi-algebras

Bi-algebras have two algebraic operations. Besides ordinary multiplication  $\mu : H \otimes H \rightarrow H$  there is also co-multiplication  $\Delta : H \rightarrow H \otimes H$ . Algebra satisfies the associativity axiom (Ass):  $a(bc) = (ab)c$ , or more formally,  $\mu(id \otimes \mu) = \mu(\mu \otimes id)$ , and the unit axiom (Un) stating that there is morphism  $\eta : k \rightarrow A$  mapping the unit of  $A$  to the unit of field  $k$ . Commutativity axiom (Co)  $ab = ba$  translates to  $\mu \otimes \tau \equiv \mu^{op} = \mu$ , where  $\tau$  permutes factors in tensor product  $A \otimes A$ .

$\Delta$  satisfies mirror images of these axioms. Co-associativity axiom (Coass) reads as  $(\Delta \otimes id)\Delta = (id \otimes \Delta)\Delta$ , co-unit axiom (Coun) states existence of morphism  $\epsilon : k \rightarrow C$  mapping the unit of  $A$  to that of  $k$ , and co-commutativity (Coco) reads as  $\tau \circ \Delta \equiv \Delta^{op} = \Delta$ . For a bi-algebra  $H$  also additional axioms are satisfied: in particular,  $\Delta(\mu)$  acts as algebra (bi-algebra) morphism. When represented graphically, this constraint states that a box diagram is equivalent to a tree diagram as will be found and served as the stimulus for the idea that loop diagrams might be equivalent with tree diagrams.

Left and right algebra modules and algebra representations are defined in an obvious manner and satisfy associativity and unit axioms. A left co-module corresponds a pair  $(V, \Delta_V)$  where the co-

action  $\Delta_N : V \rightarrow A \otimes V$  satisfies co-associativity and co-unit axioms. Right co-module is defined in an analogous manner.

Particle fusion  $A \otimes B \rightarrow C$  corresponds to  $\mu : A \otimes B \rightarrow C = AB$ . Co-multiplication  $\Delta$  corresponds time reversal  $C \rightarrow A \otimes B$  of this process, which is kind of a time-reversal for multiplication. The generalization would mean that  $\mu$  and  $\Delta$  become morphisms  $\mu : B \otimes C \rightarrow A$  and  $\Delta : A \rightarrow B \otimes C$ , where  $A, B, C$  are objects of the quantum category. They could be either representations of same algebra or even different algebras.

### 2. Drinfeld's quantum double

Drinfeld's quantum double [?] is a braided Hopf algebra obtained by combining Hopf algebra  $(H, \mu, \Delta, \eta, \epsilon, S, R)$  and its dual  $H^*$  to a larger Hopf algebra known as quasi-triangular Hopf algebra satisfying  $\Delta = R\Delta^{op}R^{-1}$ , where  $\Delta^{op}(a)$  is obtained by permuting the two tensor factors. Duality means existence of a scalar product and the two algebras correspond to Hermitian conjugates of each other.

In TGD framework the physical states associated with these algebras have opposite energies since in TGD framework antimatter (or matter depending on the phase of matter) corresponds to negative energy states. The states of the Universe would correspond to states with vanishing conserved quantum numbers, and in concordance with crossing symmetry, particle reactions could be interpreted as transitions generating zero energy states from vacuum.

The notion of duality [?] is needed to define an inner product and S-matrix. Essentially Dirac's bra-ket formalism is in question. The so called evaluation map  $ev : V \otimes V^* \rightarrow k$  defined as  $ev(v^i \otimes v_j) = \langle v^i, v_j \rangle = \delta_{ij}$  defines an inner product in any Hopf algebra module. The inverse of this map is the linear map  $k \rightarrow V$  defined by  $\delta_v(1) = v_i \otimes v^i$ . For a tensor category with unit  $I$ , field  $k$  is replaced with unit  $I$ , and left duality these maps are replaced with maps  $b_V : I \rightarrow V \otimes V^*$  and  $d_V : V \otimes V^* \rightarrow I$ . Right duality is defined in an analogous manner. The map  $d_V$  assigns to a given zero energy state S-matrix element. Algebra morphism property  $b_V(ab) = b_V(a)b_V(b)$  would mean that the outcome is essentially the counterpart of free field theory Feynman diagram. This diagram is convoluted with the S-matrix element coded to the entanglement coefficients between positive and negative energy particles of zero energy state.

### 3. Ribbon algebras and ribbon categories

The so called ribbon algebra [?] is obtained by replacing one-dimensional strands with ribbons and adding to the algebra the so called twist operation  $\theta$  acting as a morphism in algebra and in any algebra module. Twist allows to introduce the notion of trace, in particular quantum trace.

The thickening of one-dimensional strands to 2-dimensional ribbons is especially natural in TGD framework, and corresponds to a replacement of points of time=constant section of 4-surface with one-dimensional curves along which the S-matrix defined by R-matrix is constant. Ribbon category is defined in an obvious manner. There is also a more general definition of ribbon category with objects identified as representations of a given algebra and allowing morphisms with arbitrary number of incoming and outgoing strands having interpretation as many-particle vertices in TGD framework. The notion of quantum category defined as a generalization of a ribbon category involving the generalization of algebra product and co-product as morphisms between different objects of the category and allowing objects to correspond different algebras might catch the essentials of the physics of TGD Universe.

## A-2.2 Algebras, co-algebras, bi-algebras, and related structures

It is useful to formulate the notions of algebra, co-algebra, bi-algebra, and Hopf algebra in order to understand how they might help in attempt to formulate more precisely the view about what generalized Feynman diagrams could mean. Since I am a novice in the field of quantum groups, the definitions to be represented are more or less as such from the book "Quantum Groups" of Christian Kassel [?] with some material (such as the construction of Drinfeld double) taken from [?]. What is new is a graphical representation of algebra axioms and the proposal that algebra and co-algebra operations have interpretation in terms of generalized Feynman diagrams.

In the following considerations the notation  $id_k$  for the isomorphism  $k \rightarrow k \otimes k$  defined by  $x \rightarrow x \otimes x$  and its inverse will be used.

**Algebras**

Algebra can be defined as a triple  $(A, \mu, \eta)$ , where  $A$  is a vector space over field  $k$  and  $\mu : A \otimes A \rightarrow A$  and  $\eta : k \rightarrow A$  are linear maps satisfying the following axioms (Ass) and (Un).

(Ass): The square

$$\begin{array}{ccc}
 A \otimes A \otimes A & \xrightarrow{\mu \otimes id} & A \otimes A \\
 \downarrow id \otimes \mu & & \downarrow \mu \\
 A \otimes A & \xrightarrow{\mu} & A
 \end{array} \tag{A-2.1}$$

commutes.

(Un): The diagram

$$\begin{array}{ccccc}
 k \otimes A & \xrightarrow{\eta \otimes id} & A \otimes A & \xleftarrow{id \otimes \eta} & A \otimes k \\
 & \searrow \cong & \downarrow \mu & & \swarrow \cong \\
 & & A & & 
 \end{array} \tag{A-2.2}$$

commutes. Note that  $\eta$  imbeds field  $k$  to  $A$ .

(Comm) If algebra is commutative, the triangle

$$\begin{array}{ccc}
 A \otimes A & \xrightarrow{\tau_{A,A}} & A \otimes A \\
 \searrow \mu & & \swarrow \mu \\
 & & A
 \end{array} \tag{A-2.3}$$

commutes. Here  $\tau_{A,A}$  is the flip switching the factors:  $\tau_{A,A}(a \otimes a') = a' \otimes a$ .

A morphism of algebras  $f : (A, \mu, \eta) \rightarrow (A', \mu', \eta')$  is a linear map  $A \rightarrow A'$  such that

$$\mu' \circ (f \otimes f) = f \circ \mu, \text{ and } f \circ \eta = \eta' .$$

A graphical representation of the algebra axioms is obtained by assigning to the field  $k$  a dashed line to be referred as a vacuum line in the sequel and to  $A$  a full line, to  $\eta$  a vertex  $\times$  at which  $k$ -line changes to  $A$ -line. The product  $\mu$  can be represented as 3-particle vertex in which algebra lines fuse together. The three axioms (Ass), (Un) and (Comm) can be expressed graphically in figure A-2.2. Note that associativity axiom implies that two tree diagrams not equivalent as Feynman diagrams are equivalent in the algebraic sense.

**Co-algebras**

The definition of co-algebra is obtained by systematically reversing the directions of arrows in the previous diagrams.

A co-algebra is a triple  $(C, \Delta, \epsilon)$ , where  $C$  is a vector space over field  $k$  and  $\Delta : C \rightarrow C \otimes C$  and  $\epsilon : C \rightarrow k$  are linear maps satisfying the following axioms (Coass) and (Coun).

(Coass): The square

$$\begin{array}{ccc}
 C & \xrightarrow{\Delta} & C \otimes C \\
 \downarrow \Delta & & \downarrow id \otimes \Delta \\
 C \otimes C & \xrightarrow{\Delta \otimes id} & C \otimes C \otimes C
 \end{array} \tag{A-2.4}$$

commutes.

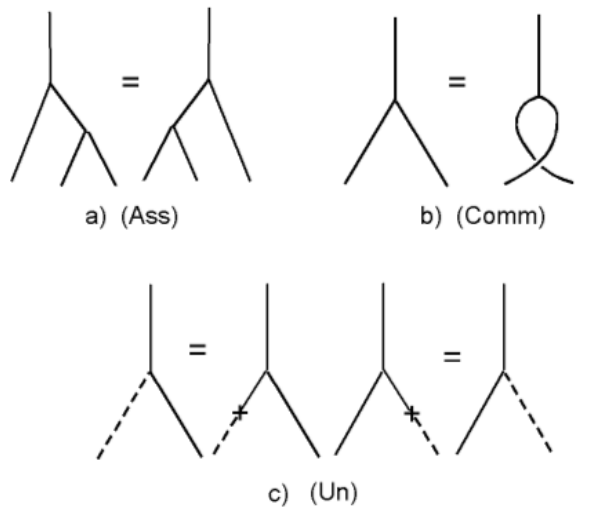

Figure 1: Graphical representation for the axioms of algebra. a)  $a(bc) = (ab)c$ , b)  $ab = ba$ , c)  $ka = \mu(\eta(k), a)$  and  $ak = \mu(a, \eta(k))$ .

(Coun): The diagram

$$\begin{array}{ccccc}
 k \otimes C & \xleftarrow{\epsilon \otimes id} & C \otimes C & \xrightarrow{id \otimes \epsilon} & C \otimes k \\
 & \searrow \cong & \Delta \uparrow & \nearrow \cong & \\
 & & C & & 
 \end{array}
 \tag{A-2.5}$$

commutes. The map  $\Delta$  is called co-product or co-multiplication whereas  $\epsilon$  is called the counit. The commutative diagram state that the co-product is co-associative and that co-unit commutes with co-product.

(Cocomm) If co-algebra is commutative, the triangle

$$\begin{array}{ccc}
 & C & \\
 \Delta \swarrow & & \searrow \Delta \\
 C \otimes C & \xrightarrow{\tau_{C,C}} & C \otimes C
 \end{array}
 \tag{A-2.6}$$

commutes. Here  $\tau_{C,C}$  is the flip switching the factors:  $\tau_{C,C}(c \otimes c') = c' \otimes c$ .

A morphism of co-algebras  $f : (C, \Delta, \epsilon) \rightarrow (C', \Delta', \epsilon')$  is a linear map  $C \rightarrow C'$  such that

$$(f \otimes f) \circ \Delta = \Delta' \circ f, \text{ and } \epsilon = \epsilon' \circ f.$$

It is straightforward to define notions like co-ideal and co-factor algebra by starting from the notions of ideal and factor algebra. A very useful notation is Sweedler's sigma notation for  $\Delta(x)$ ,  $x \in C$  as element of  $C \otimes C$  :

$$\Delta(x) = \sum_i x'_i \otimes x''_i \equiv \sum_{\{x\}} x' \otimes x''.$$

Also co-algebra axioms allow graphical representation. One assigns to  $\epsilon$  a vertex  $\times$  at which  $C$ -line changes to  $k$ -line: the interpretation is as an absorption of a particle by vacuum. The co-product  $\Delta$  can be represented as 3-particle vertex in which  $C$ -line decays to two  $C$ -lines. The graphical representation of the three axioms (Coass), (Coun), and (Cocomm) is related to the representation of algebra axioms by "time reversal", that is turning the diagrams for the algebra axioms upside down (see figure A-2.2).

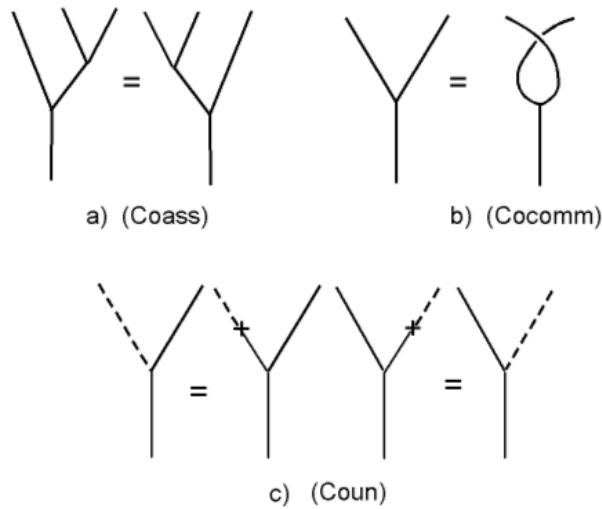

Figure 2: Graphical representation for the axioms of co-algebra is obtained by turning the representation for algebra axioms upside down. a)  $(id \otimes \Delta)\Delta = (\Delta \otimes id)\Delta$ , b)  $\Delta = \Delta^{op}$ , c)  $(\epsilon \otimes id) \circ \Delta = (id \otimes \epsilon) \circ \Delta = id$ .

**Bi-algebras**

Consider next a vector space  $H$  equipped simultaneously with an algebra structure  $(H, \mu, \eta)$  and a co-algebra structure  $(H, \Delta, \epsilon)$ . There are some compatibility conditions between these two structures.  $H \otimes H$  can be given the induced structures of a tensor product of algebras and of co-algebras.

The following two statements are equivalent.

1. The maps  $\mu$  and  $\eta$  are morphisms of co-algebras. For  $\mu$  this means that the diagrams

$$\begin{array}{ccc}
 H \otimes H & \xrightarrow{\mu} & H \\
 \downarrow (id \otimes \tau \otimes id) \otimes (\Delta \otimes \Delta) & & \downarrow \Delta \\
 (H \otimes H) \otimes (H \otimes H) & \xrightarrow{\mu \otimes \mu} & H \otimes H
 \end{array} \tag{A-2.7}$$

and

$$\begin{array}{ccc}
 H \otimes H & \xrightarrow{\epsilon \otimes \epsilon} & k \otimes k \\
 \downarrow \mu & & \downarrow id \\
 H & \xrightarrow{\epsilon} & k
 \end{array} \tag{A-2.8}$$

commute. For  $\eta$  this means that the diagrams

$$\begin{array}{ccc}
 k & \xrightarrow{\eta} & H \\
 \downarrow id & & \downarrow \Delta \\
 k \otimes k & \xrightarrow{\eta \otimes \eta} & H \otimes H
 \end{array}
 \qquad
 \begin{array}{ccc}
 k & \xrightarrow{\eta} & H \\
 \searrow id & & \swarrow \epsilon \\
 & k &
 \end{array} \tag{A-2.9}$$

commute.

- The maps  $\Delta$  and  $\epsilon$  are morphisms of algebras.  
For  $\Delta$  this means that diagrams

$$\begin{array}{ccc}
 H \otimes H & \xrightarrow{\Delta \otimes \Delta} & (H \otimes H) \otimes (H \otimes H) \\
 \downarrow \mu & & \downarrow (\mu \otimes \mu)(id \otimes \tau \otimes id) \\
 H & \xrightarrow{\Delta} & H \otimes H
 \end{array} \tag{A-2.10}$$

and

$$\begin{array}{ccc}
 k & \xrightarrow{\eta} & H \\
 \downarrow id & & \downarrow \Delta \\
 k \otimes k & \xrightarrow{\eta \otimes \eta} & H \otimes H
 \end{array} \tag{A-2.11}$$

commute.

For  $\epsilon$  this means that the diagrams

$$\begin{array}{ccc}
 H \otimes H & \xrightarrow{\epsilon \otimes \epsilon} & k \otimes k & \begin{array}{ccc} k & \xrightarrow{\eta} & H \\ & \searrow id & \swarrow \epsilon \\ & & k \end{array} \\
 \downarrow \mu & & \downarrow id & \\
 H & \xrightarrow{\epsilon} & k & 
 \end{array} \tag{A-2.12}$$

commute. The proof of the theorem involves the comparison of the commutative diagrams expressing both statements to see that they are equivalent.

The theorem inspires the following definition.

**Definition:** A bi-algebra is a quintuple  $(H, \mu, \eta, \Delta, \epsilon)$ , where  $(H, \mu, \eta)$  is an algebra and  $(H, \Delta, \epsilon)$  is co-algebra satisfying the mutually equivalent conditions of the previous theorem. A morphisms of bi-algebras is a morphism for the underlying algebra and bi-algebra structures.

An element  $x \in H$  is known as primitive if one has  $\Delta(x) = 1 \otimes x + x \otimes 1$  and have  $\epsilon(x) = 0$ . The subspace of primitive elements is closed with respect to the commutator  $[x, y] = xy - yx$ . Note that for primitive elements  $\mu \circ \Delta = 2id_H$  holds true so that  $\mu/2$  acts as the left inverse of  $\Delta$ .

Given a vector space  $V$ , there exists a unique bi-algebra structure on the tensor algebra  $T(V)$  such that  $\Delta(v) = 1 \otimes v + v \otimes 1$  and  $\epsilon(v) = 0$  for any element  $v$  of  $V$ . By the symmetry of  $\Delta$  this bi-algebra structure is co-commutative and corresponds to the "classical limit". Also the Grassmann algebra associated with  $V$  allows bi-algebra structure defined in the same manner.

Figure A-2.2 provides a representation for the axioms of bi-algebra stating that  $\Delta$  and  $\epsilon$  act as algebra morphisms of algebra and or equivalent that  $\mu$  and  $\eta$  act as co-algebra morphisms. The axiom stating that  $\Delta$  ( $\mu$  is algebra (co-algebra) morphism implies that scattering diagrams differing by a box loop are equivalent. The statement that  $\mu$  is co-algebra morphism reads  $(id \otimes \mu \otimes id)(\Delta \otimes \Delta) = \Delta \circ \mu$  whereas the mirror statement  $\Delta(ab) = \Delta(a)\Delta(b)$  for  $\Delta$  reads as  $\Delta \circ \mu = \mu(\Delta \otimes \Delta)$  and gives rise to the same graph.

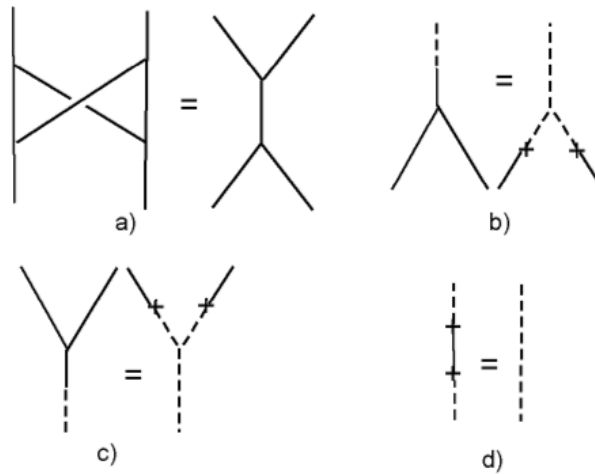

Figure 3: Graphical representation for the conditions guaranteeing that  $\mu$  and  $\eta$  ( $\Delta$  and  $\epsilon$ ) act as homomorphisms of co-algebra (algebra). a)  $(id \otimes \mu \otimes id)(\Delta \otimes \Delta) = \Delta \circ \mu$ , b)  $\epsilon \circ \mu = id \circ (\epsilon \otimes \epsilon)$ , c)  $\Delta \circ \eta = \mu \otimes id_k$ , d)  $\epsilon \circ \eta = id_k$ .

**Hopf algebras**

Given an algebra  $(A, \mu, \eta)$  and co-algebra  $(C, \Delta, \epsilon)$ , one can define a bilinear map, the convolution on the vector space  $Hom(C, A)$  of linear maps from  $C$  to  $A$ . By definition, if  $f$  and  $g$  are such linear maps, then the convolution  $f \star g$  is the composition of the maps

$$C \xrightarrow{\Delta} C \otimes C \xrightarrow{f \otimes g} A \otimes A \xrightarrow{\mu} A \tag{A-2.13}$$

Using Sweedler’s sigma notation one has

$$f \star g(x) = \sum_{\{x\}} f(x')g(x'') \tag{A-2.14}$$

It can be shown that the triple  $(Hom(C, A), \star, \Delta, \eta \circ \epsilon)$  is an algebra and that the map  $\Lambda_{C,A} : A \otimes C^* \rightarrow Hom(C, A)$  defined as

$$\Lambda_{C,A}(a \otimes \gamma)(c) = \gamma(c)a$$

is a morphism of algebras, where  $C^*$  is the dual of the finite-dimensional co-algebra  $C$ .

For  $A = C$  the result gives a mathematical justification for the crossing symmetry inspired re-interpretation of the unitary S-matrix interpreted usually as an element of  $Hom(A, A)$  as a state generated by element of  $A \otimes A^*$  from the vacuum  $|vac\rangle = |vac_A\rangle \otimes |vac_{A^*}\rangle$ . This corresponds to the interpretation of the reaction  $a_i|vac_A\rangle \rightarrow a_f|vac_A\rangle$  as a transition creating state  $a_i \otimes a_f^*|vac\rangle$  with vanishing conserved quantum numbers from vacuum.

With these prerequisites one can introduce the notion of Hopf algebra. Let  $(H, \mu, \eta, \Delta, \epsilon)$  be a bi-algebra. An endomorphism  $S$  of  $H$  is called an antipode for the bi-algebra  $H$  if

$$S \star id_H = id_H \star S = \eta \circ \epsilon \tag{A-2.15}$$

A Hopf algebra is a bi-algebra with an antipode. A morphism of a Hopf algebra is a morphism between the underlying bi-algebras commuting with the antipodes.

The graphical representation of the antipode axiom is given in the figure below.

The notion of scalar product central for physical applications boils down to the notion of duality. Duality between Hopf algebras  $U$  and  $H$  means the existence of a morphism  $x \rightarrow \Psi(x): H \rightarrow U^*$

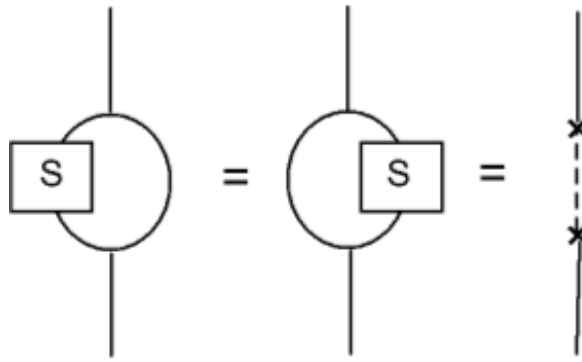

Figure 4: Graphical representation of antipode axiom  $S \star id_H = id_H \star S = \eta \circ \epsilon$ .

defined by a bilinear form  $\langle u, x \rangle = \Psi(x)(u)$  on  $U \times H$ , which is a bi-algebra morphism. This means that the conditions

$$\begin{aligned}
 \langle uv, x \rangle &= \langle u \otimes v, \Delta(x) \rangle, & \langle u, xy \rangle &= \langle \Delta(u), x \otimes y \rangle, \\
 \langle 1, x \rangle &= \epsilon(x), & \langle u, 1 \rangle &= \epsilon(u), \\
 \langle S(u), x \rangle &= \langle u, S(x) \rangle
 \end{aligned}
 \tag{A-2.15}$$

are satisfied. The first condition on multiplication and co-multiplication, when expressed graphically, states that the decay  $x \rightarrow u \otimes v$  can be regarded as time reversal for the fusion of  $u \otimes v \rightarrow x$ . Second condition has analogous interpretation.

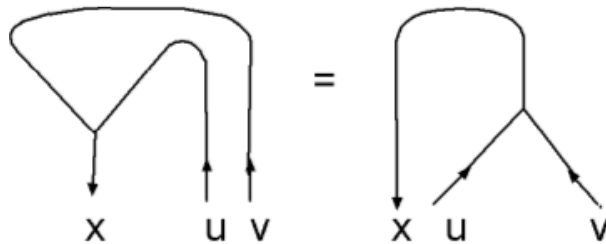

Figure 5: Graphical representation of the duality condition  $\langle uv, x \rangle = \langle u \otimes v, \Delta(x) \rangle$ .

### Modules and comodules

Left and right algebra modules and algebra representations are defined in an obvious manner and satisfy associativity and unit axioms having diagrammatic representation similar to that for corresponding algebra axioms.

A left co-module corresponds a pair  $(V, \Delta_V)$ , where the co-action  $\Delta_N: V \rightarrow C \otimes V$  satisfies co-associativity axiom  $(id_C \otimes \Delta_N) \circ \Delta_N = (\Delta \otimes id_N) \circ \Delta_N$  and co-unit axiom  $(\epsilon \otimes id) \circ \Delta_N = id_N$ . A right co-module is defined in an analogous manner. It is convenient to introduce Sweedlers's notation for  $\Delta_N$  as  $\Delta_N = \sum_{\{c\}} x_C \otimes x_N$ .

One can define module and comodule morphisms and tensor product of modules and co-modules in a rather obvious manner. The module  $N$  could be also algebra, call it  $A$ , in which case  $\mu_A$  and  $\eta_A$  are assumed to act as H-comodule morphisms.



The standard example is quantum plane  $A = M(2)_q$  is the free algebra generated variables  $x, y$  subject to relations  $yx = qxy$  and having coefficients in  $k$ . The action of  $\Delta_A$  reads as

$$\Delta_A \begin{pmatrix} x \\ y \end{pmatrix} = \begin{pmatrix} a & b \\ c & d \end{pmatrix} \otimes \begin{pmatrix} x \\ y \end{pmatrix} .$$

$\Delta_A$  defines algebra morphism from  $A$  to  $SL(2)_q \otimes A$ :  $\Delta_a(yx) = \Delta_A(y)\Delta_A(x) = q\Delta_A(x)\Delta_A(y) = \Delta(qxy)$ .

**Braided bi-algebras**

$\Delta^{op} = \tau_{H,H} \circ \Delta$  defines the opposite co-algebra  $H^{op}$  of  $H$ . A braided bi-algebra  $(H, \mu, \eta, \Delta, \epsilon)$  is called quasi-co-commutative (or quasi-triangular) if there exists an element  $R$  of algebra  $H \otimes H$  such that for all  $x \in H$  one has

$$\Delta^{op} = R\Delta R^{-1} .$$

One can express  $R$  in the form

$$R = \sum_i s_i \otimes t_i .$$

It is convenient to denote by  $R_{ij}$  the  $R$  matrix acting in  $i^{th}$  and  $j^{th}$  tensor factors of  $n^{th}$  tensor power of  $H$ . More precisely,  $R_{ij}$  can be defined as an operator acting in an  $n$ -fold tensor power of  $H$  by the formula  $R_{ij} = y^{(1)} \otimes y^{(2)} \otimes \dots \otimes y^{(p)}$ ,  $p \leq n$ ,  $y^{(k_i)} = s_i$  and  $y^{(k_j)} = t_j$ ,  $y^{(k)} = 1$  otherwise. For instance, one has  $R_{13} = \sum_i s_i \otimes 1 \otimes t_i$ .

With these prerequisites one can define a braided bi-algebra as a quasi-commutative bi-algebra  $(H, \mu, \eta, \Delta, \epsilon, S, S^{-1}, R)$  as an algebra with a preferred element  $R \in H \otimes H$  satisfying the two relations

$$\begin{aligned} (\Delta \otimes id_H)(R) &= R_{13}R_{23} , \\ (id_H \otimes \Delta)(R) &= R_{13}R_{12} . \end{aligned} \tag{A-2.16}$$

Braided bi-algebras, known also as quasi-triangular bi-algebras, are central in the theory of quantum groups, R-matrices, and braid groups. By a direct calculations one can verify the following relations.

1. Yang-Baxter equations

$$R_{12}R_{13}R_{23} = R_{23}R_{13}R_{12} , \tag{A-2.17}$$

and the relation

$$(\epsilon \otimes id_H)(R) = 1 \tag{A-2.18}$$

hold true.

2. Since  $H$  has an invertible antipode  $S$ , one has

$$\begin{aligned} (S \otimes id_H)(R) &= R^{-1} = (id_H \otimes S^{-1})(R) , \\ (S \otimes S)(R) &= R . \end{aligned} \tag{A-2.19}$$

The graphical representation of the Yang-Baxter equation in terms of the relations of braid group generators is given in the figure A-2.2.

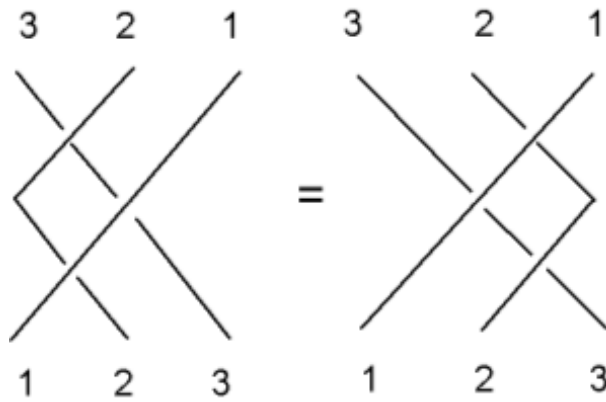

Figure 6: Graphical representation of Yang-Baxter equation  $R_{12}R_{13}R_{23} = R_{23}R_{13}R_{12}$ .

**Ribbon algebras**

Let  $H$  be a braided Hopf algebra with a universal matrix  $R = \sum_i s_i \otimes t_i$  and set  $u = \sum_i S(t_i)s_i$ . It can be shown that  $u$  is invertible with the inverse  $u^{-1} = \sum_i s_i S^2(t_i)$  and that  $uS(u) = S(u)u$  is central element in  $H$ . Furthermore, one has  $\epsilon(u) = 1$  and  $\Delta(u) = (R_{21}R)^{-1}(u \otimes u)$ , and the antipode is given for any  $x \in H$  by  $S^2(x) = uXu^{-1}$ .

Ribbon algebra has besides  $R \in H \otimes H$  also a second preferred element called  $\theta$ . A braided Hopf algebra is called ribbon algebra if there exists a central element  $\theta$  of  $H$  satisfying the relations

$$\Delta(\theta) = (R_{21}R)^{-1}(\theta \otimes \theta) , \quad \epsilon(\theta) = 1 , \quad S(\theta) = \theta . \tag{A-2.20}$$

It can be shown that  $\theta^2$  acts like  $S(u)u$  on any finite-dimensional module [?] .

**Drinfeld’s quantum double**

Drinfeld’s quantum double construction allows to build a quasi-triangular Hopf algebra by starting from any Hopf algebra  $H$  and its dual  $H^*$ , which exists in a finite-dimensional case always, and as a vector space is isomorphic with  $H$ . Besides duality normal ordering is second ingredient of the construction. Physically the generators of the algebra and its dual correspond to creation and annihilation operator type operators. Drinfeld’s quantum double construction is represented in a very general manner in [?] . A construction easier to understand by a physicist is discussed in [?]. For this reason this representation is summarized here although the style differs from the representation of [?] followed in the other parts of appendices.

Consider first what is known.

1. Duality means the existence of basis  $\{e_a\}$  for  $H$  and  $\{e^a\}$  for  $H^*$  and inner product (or evaluation as it is called in [?] )  $ev : H^* \otimes H \rightarrow k$  defined as  $ev(e^a e_b) \equiv \langle e^a, e_b \rangle = \delta_b^a$  and its inverse  $\delta : k \rightarrow H^* \otimes H$  defined by  $\delta(1) = e^a e_a$ . One can extend the inner product to an inner product in the tensor product  $(H^* \otimes H^*) \otimes (H \otimes H)$  in an obvious manner.
2. The product (co-product) in  $H$  ( $H^*$ ) coincides with the co-product (product) in  $H^*$  ( $H$ ) in the sense that one has

$$\begin{aligned} \langle e^c, e_a e_b \rangle &= m_{ab}^c = \langle \Delta(e^c), e_b \otimes e_a \rangle , \\ \langle e^a e^b, e_c \rangle &= \mu_c^{ab} = \langle e^a \otimes e^b, \Delta(e_c) \rangle , \end{aligned} \tag{A-2.21}$$

These equations are quite general expressions for the duality expressed graphically in figure A-2.2.

3. The antipodes  $S$  for  $H$  and  $H^*$  can be represented as matrices

$$S_H(e_a) = S_a^b e_b \quad , \quad S_{H^*}(e^a) = (S^{-1})^a_b e^b \quad . \quad (\text{A-2.22})$$

The task is to construct algebra product  $\mu$  and co-algebra product  $\Delta$ , unit  $\eta$  and co-unit  $\epsilon$ , antipode, and R-matrix  $R$  for  $H \otimes H^*$ . The natural basis for  $H \otimes H^*$  consists of  $e_a \otimes e^b$ .

1. Co-product  $\Delta$  is simply the product of co-products

$$\Delta(e_a e^b) = \Delta(e_a) \Delta(e^b) = m_{vu}^b \mu_a^{cd} e_c e^u \otimes e_d e^v \quad . \quad (\text{A-2.23})$$

2. Product  $\mu$  involves normal ordering prescription allowing to transform products  $e^a e_b$  (elements of  $H^* \otimes H$ ) to combinations of basis elements  $e_a e^b$  (elements of  $H \otimes H^*$ ). This map must be consistent with the requirement that co-product acts as an algebra morphism. Drinfeld's normal ordering prescription, or rather a map  $c_{H^*,H}: H^* \otimes H \rightarrow H \otimes H^*$  is given by

$$c_{H^*,H}(e^a e_b) = R_{bd}^{ac} e_c e^d \quad , \quad R_{bd}^{ac} = m_{kd}^x m_{xu}^a \mu_b^{vy} \mu_y^{ck} (S^{-1})^u_v e_c e^d \quad . \quad (\text{A-2.24})$$

The details of the formula are far from being obvious: the axioms of tensor category with duality to be discussed later might allow to relate  $R_{H^*,H}$  to  $R_{H,H}$  and this might help to understand the origin of the expression. Normal ordering map can be interpreted as braid operation exchanging  $H$  and  $H^*$  and the matrix defining the map could be regarded as R-matrix  $R_{H \otimes H^*}$ .

3. The universal R-matrix is given by

$$R = (e_a \otimes id_{H^*}) \otimes (id_H \otimes e^a) \quad , \quad (\text{A-2.25})$$

where the summation convention is applied. One can show that  $R\Delta = \Delta^{op}R$  by a direct calculation.

4. The antipode  $S_{H \otimes H^*}$  follows from the product of antipodes for  $H$  and  $H^*$  using the fact that antipode is antihomomorphism using the normal ordering prescription

$$S_{H \otimes H^*}(e_a e^b) = c_{H^*,H}(S(e^b) S(e_a)) \quad . \quad (\text{A-2.26})$$

**Quasi-Hopf algebras and Drinfeld associator**

Braided Hopf algebras are quasi-commutative in the sense that one has  $\Delta^{op} = R\Delta R^{-1}$ . Also the strict co-associativity can be given up and this means that one has

$$(\Delta \otimes id)\Delta = \Phi(id \otimes \Delta)\Phi^{-1} \quad , \quad (\text{A-2.27})$$

where  $\Phi \in H \otimes H \otimes H$  is known as Drinfeld's associator and appears in the of conformal fields theories. If the resulting structure satisfies also the so called Pentagon Axiom (to be discussed later, see Eq. A-2.36 and figure A-2.3), it is called quasi-Hopf algebra. Pentagon Axiom boils down to the condition

$$(id \otimes id \otimes \Delta)(\Phi)(\Delta \otimes id \otimes id)(\Phi) = (id \otimes \Phi)(id \otimes id \otimes \Delta)(\Phi)(\Phi \otimes id) \quad . \quad (\text{A-2.28})$$

The Yang-Baxter equation for quasi-Hopf algebra reads as

$$R_{12}\Phi_{312}R_{13}\Phi_{1322}^{-1}R_{23}\Phi_{123} = \Phi_{321}R_{23}\Phi_{231}^{-1}R_{13}\Phi_{213}R_{12}\Phi_{123} . \tag{A-2.29}$$

The left-hand side arises from a sequence of transformations

$$(12)3 \xrightarrow{\Phi_{123}} 1(23) \xrightarrow{R_{23}} 1(32) \xrightarrow{\Phi_{132}^{-1}} (31)2 \xrightarrow{R_{13}} 3(12) \xrightarrow{\Phi_{312}} 3(12) \xrightarrow{R_{12}} 3(21) .$$

The right-hand side arises from the sequence

$$(12)3 \xrightarrow{R_{12}} (21)3 \xrightarrow{\Phi_{213}} 2(13) \xrightarrow{R_{13}} 2(31) \xrightarrow{\Phi_{231}^{-1}} (23)1 \xrightarrow{R_{23}} (32)1 \xrightarrow{\Phi_{321}} 3(21) .$$

One can produce new quasi-Hopf algebras by gauge (or twist) transformations using invertible element  $\Omega \in H \otimes H$  called twist operator

$$\begin{aligned} \Delta(a) &\rightarrow \Omega\Delta(a)\Omega^{-1} , \\ \Phi &\rightarrow \Omega_{23}(id \otimes \Delta)(\Omega)\Phi(\Delta \otimes id)(\Omega^{-1})\Omega_{12}^{-1} , \\ R &\rightarrow \Omega R\Omega^{-1} . \end{aligned} \tag{A-2.30}$$

Quasi-Hopf algebras appear in conformal field theories and correspond quantum universal enveloping algebras divided by their centralizer. Consider as an example the R-matrix  $R^{j_1, j_2}$  relating  $j_1 \otimes j_2$  and  $j_2 \otimes j_1$  representations  $\Delta^{j_1, j_2}(a)$  and  $\Delta^{j_2, j_1}(a)$  of the co-product  $\Delta$  of  $U(sl(2))_q$ .  $\Delta^{j, j}(a)$  commutes with  $R^{j, j}$  for all elements of the quantum group. The action of  $g_i = qR^{j, j}$  acting in  $i^{th}$  and  $(i + 1)^{th}$  tensor factors extends to the representation  $(V_j)^{\otimes n}$  in an obvious manner. From the Yang-Baxter equation it follows that the operators  $g_i$  define a representation of braid group  $B_n$ :

$$\begin{aligned} g_i g_{i+1} g_i &= g_{i+1} g_i g_{i+1} , \\ g_i g_j &= g_j g_i , \text{ for } |j - k| \geq 2 . \end{aligned} \tag{A-2.31}$$

Under certain conditions the braid group generators generate the whole centralizer  $C_q^n$  for the representation of quantum group. For instance, this occurs for  $j = 1/2$ . In this case the additional condition

$$g_i^2 = (q^2 - 1)g_i + q^2 \times 1 , \tag{A-2.32}$$

so that the centralizer is isomorphic with the Hecke algebra  $H_n(q)$ , which can be regarded as a q-deformation of permutation group  $S_n$ .

The result generalizes. In Wess-Zumino-Witten model based on group  $G$  the relevant algebraic structure is  $U(G_q)/C^n(q)$ . This is quasi-Hopf algebra and the so called Drinfeld associator characterizes the quasi-associativity.

### A-2.3 Tensor categories

Hopf algebras and related structures do not seem to be quite enough in order to formulate elegantly the construction of S-matrix in TGD framework. A more general structure known as a braided tensor category with left duality and twist operation making the category to a ribbon category is needed. The algebra product  $\mu$  and co-product  $\Delta$  must be generalized so that they appear as morphisms  $\mu_{A \otimes B \rightarrow C}$  and  $\Delta_{A \rightarrow B \otimes C}$ : this gives hopes of describing 3-vertices algebraically. It is not clear whether one can assume single underlying algebra so that objects would correspond to different representations of this algebra or whether one allow even non-isomorphic algebras.

In the tensor category the tensor products of objects and corresponding morphisms belong to the category. In a braided category the objects  $U \otimes V$  and  $V \otimes U$  are related by a braiding morphism.

The notion of braided tensor category appears naturally in topological and conformal quantum field theories and seems to be an appropriate tool also in TGD context. The basic category theoretical notions are discussed in [?] and I have already earlier considered category theory as a possible tool in the construction of quantum TGD and TGD inspired theory of consciousness [?] .

In braided tensor categories one introduces the braiding morphism  $c_{V,W} : V \otimes W \rightarrow W \otimes V$ , which is closely related to R-matrix. In categories allowing duality arrows with both directions are allowed ad diagrams analogous to pair creation from vacuum are possible. In ribbon categories one introduces also the twist operation  $\theta_V$  as a morphism of object and the  $\Theta_W$  satisfies the axiom:  $\theta_{V \otimes W} = (\theta_V \otimes \theta_W)c_{W,V}c_{V,W}$ . One can also introduce morphisms with arbitrary number of incoming lines and outgoing lines and visualize them as boxes, coupons. Isotopy principle, originally related to link and knot diagrams provides a powerful tool allowing to interpret the basic axioms of ribbon categories in terms of isotopy invariance of the diagrams and to invent theorems by just isotoping.

**Categories, functors, natural transformations**

Categories [?, ?, ?, ?] are roughly collections of objects A, B, C... and morphisms  $f(A \rightarrow B)$  between objects A and B such that decomposition of two morphisms is always defined. Identity morphisms map objects to objects. Examples of categories are open sets of some topological spaces with continuous maps between them acting as morphisms, linear spaces with linear maps between them acting as morphisms, groups with group homomorphisms taking the role of morphisms. Practically any collection of mathematical structures can be regarded as a category. Morphisms can be very general: for instance, partial ordering  $a \leq b$  can define a morphism  $f(A \rightarrow B)$ .

Functors between categories map objects to objects and morphisms to morphisms so that a product of morphisms is mapped to the product of the images and identity morphism is mapped to identity morphism. Functor  $F : \mathcal{C} \rightarrow \mathcal{D}$  commutes also with the maps  $s$  and  $b$  assigning to a morphism  $f : V \rightarrow W$  its source  $s(f) = V$  and target  $b(f) = W$ .

A natural transformation between functors  $F$  and  $G$  from  $\mathcal{C} \rightarrow \mathcal{C}'$  is a family of morphisms  $\eta(V) : F(V) \rightarrow G(V)$  in  $\mathcal{C}'$  indexed by objects  $V$  of  $\mathcal{C}$  such that for any morphisms  $f : V \rightarrow W$  in  $\mathcal{C}$ , the square

$$\begin{array}{ccc}
 F(V) & \xrightarrow{\eta(V)} & G(V) \\
 \downarrow F(f) & & \downarrow G(f) \\
 F(W) & \xrightarrow{\eta(W)} & G(W)
 \end{array} \tag{A-2.33}$$

commutes.

The functor  $F : \mathcal{C} \rightarrow \mathcal{D}$  is said to be equivalence of categories if there exists a functor  $G : \mathcal{D} \rightarrow \mathcal{C}$  such and natural isomorphisms

$$\eta : id_{\mathcal{D}} \rightarrow FG \text{ and } \theta : GF \rightarrow id_{\mathcal{C}}$$

The notion of adjoint functor is a more general notion than equivalence of categories. In this case  $\eta$  and  $\theta$  are natural transformations but not necessary natural isomorphisms in such a manner that the composite maps

$$\begin{array}{ccccc}
 F(V) & \xrightarrow{\eta(F(V))} & (FGF)(V) & \xrightarrow{F(\theta(V))} & F(V) \\
 \\
 G(W) & \xrightarrow{G(\eta(W))} & (GFG)(W) & \xrightarrow{\theta(G(W))} & G(W)
 \end{array} \tag{A-2.34}$$

are identify morphisms for all objects V in  $\mathcal{C}$  and W in  $\mathcal{D}$ .

The product  $C = AB$  for objects of categories is defined by the requirement that there exist projection morphisms  $\pi_A$  and  $\pi_B$  from C to A and B and that for any object D and pair of morphisms  $f(D \rightarrow A)$  and  $g(D \rightarrow B)$  there exist morphism  $h(D \rightarrow C)$  such that one has  $f = \pi_A h$  and  $g = \pi_B h$ . Graphically this corresponds to a square diagram in which pairs A,B and C,D correspond to the pairs formed by opposite vertices of the square and arrows DA and DB correspond to morphisms f and g,

arrows CA and CB to the morphisms  $\pi_A$  and  $\pi_B$  and the arrow  $h$  to the diagonal DC. Examples of product categories are Cartesian products of topological spaces, linear spaces, differentiable manifolds, groups, etc. The tensor products of linear spaces and algebras provides an especially interesting example of product in the recent case. One can define also more advanced concepts such as limits and inverse limits. Also the notions of sheafs, presheafs, and topos are important.

**Tensor categories**

Let  $\mathcal{C}$  be a category. Tensor product  $\otimes$  is a functor from  $\mathcal{C} \times \mathcal{C}$  to  $\mathcal{C}$  if

1. there is an object  $V \otimes W$  associated with any pair  $(V, W)$  of objects of  $\mathcal{C}$
2. there is an morphism  $f \otimes g$  associated with any pair  $(f, g)$  of morphisms of  $\mathcal{C}$  such that  $s(f \otimes g) = s(f) \otimes s(g)$  and  $b(f \otimes g) = b(f) \otimes b(g)$ ,
3. if  $f'$  and  $g'$  are morphisms such that  $s(f') = b(f)$  and  $s(g') = b(g)$  then  $(f' \otimes g') \circ (f \otimes g) = (f' \circ f) \otimes (g' \circ g)$  ,
4.  $id_{V \otimes W} = id_{W \otimes V}$  .

Any functor with these properties is called tensor product. The tensor product of vector spaces provides the most familiar example of a tensor product functor.

In figure 4 the general rules for graphical representations of morphisms are given.

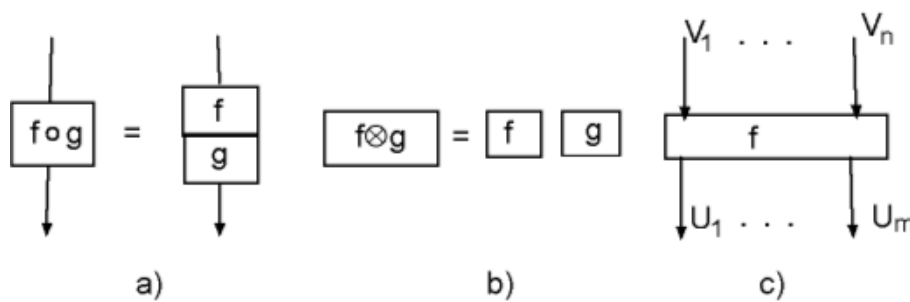

Figure 7: The graphical representation of morphisms. a)  $g \circ f: V \rightarrow W$ , b)  $f \otimes g$ , c)  $f : U_1 \otimes \dots \otimes U_m \rightarrow V_1 \otimes \dots \otimes V_n$ .

An associativity constraint for the tensor product is a natural isomorphism

$$a : \otimes(\otimes \times id) \rightarrow \otimes(id \times \otimes) .$$

On basis of general definition of natural isomorphisms (see Eq. A-2.33) one can conclude that for any triple  $(U, V, W)$  of objects of  $\mathcal{C}$  there exists an isomorphism

$$\begin{array}{ccc}
 (U \otimes V) \otimes W & \xrightarrow{a_{U,V,W}} & U \otimes (V \otimes W) \\
 \downarrow (f \otimes g) \otimes h & & \downarrow f \otimes (g \otimes h) \\
 (U' \otimes V') \otimes W' & \xrightarrow{a_{U',V',W'}} & U' \otimes (V' \otimes W')
 \end{array} \tag{A-2.35}$$

Associativity constraints satisfies Pentagon Axiom [?] if the following diagrams commutes.

$$\begin{array}{ccc}
 U \otimes (V \otimes W) \otimes X & \xleftarrow{a_{U,V,W} \otimes id_X} & ((U \otimes V) \otimes W) \otimes X \\
 \downarrow a_{U,V \otimes W, X} & & \downarrow a_{U \otimes V, W, X} \\
 & & (U \otimes V) \otimes (W \otimes X) \\
 & & \downarrow a_{U, V, W \otimes X} \\
 U \otimes ((V \otimes W) \otimes X) & \xrightarrow{id_U \otimes a_{V, W, X}} & U \otimes (V \otimes (W \otimes X))
 \end{array} \tag{A-2.36}$$

Pentagon axiom has been already mentioned while discussing the definition of quasi-Hopf algebras. In figure A-2.3 are graphical illustrations of associativity morphism  $a(U, V, W)$ , Triangle Axiom, and Pentagon Axiom are given.

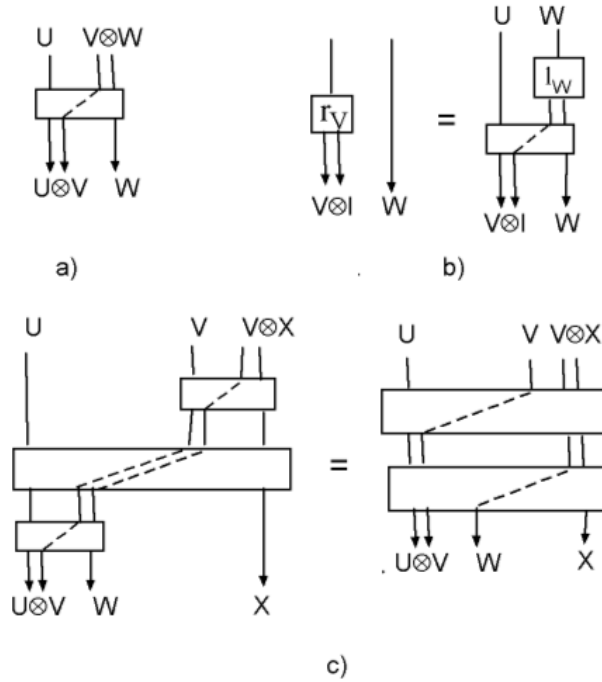

Figure 8: Graphical representations of a) the associativity isomorphism  $a_{U,V,W}$ , b) Triangle Axiom, c) Pentagon Axiom.

Assume that an object  $I$  is fixed in the category. A left unit constraint with respect to  $I$  is a natural isomorphism

$$l : \otimes(I \times id) \rightarrow id$$

By Eq. A-2.33 this means that for any object  $V$  of  $C$  there exists an isomorphism

$$l_V : I \otimes V \rightarrow V \tag{A-2.37}$$

such that

$$\begin{array}{ccc}
 I \otimes V & \xrightarrow{l_V} & V \\
 \downarrow id_I \otimes f & & \downarrow f \\
 I \otimes V' & \xrightarrow{l_{V'}} & V'
 \end{array} \tag{A-2.38}$$

The right unit constraint  $r : \otimes(id \times I) \rightarrow id$  can be defined in a completely analogous manner.

Given an associativity constraint  $a$ , and left and right unit constraints  $l, r$  with respect to an object  $I$ , one can say that the Triangle Axiom is satisfied if the triangle

$$\begin{array}{ccc}
 (V \otimes I) \otimes W & \xrightarrow{a_{V,I,W}} & V \otimes (I \otimes W) \\
 \searrow r_V \otimes id_W & & \swarrow id_W \otimes l_W \\
 & V \otimes W &
 \end{array} \tag{A-2.39}$$

commutes (see figure A-2.3).

These ingredients lead allow to define tensor category  $(\mathcal{C}, I, a, l, r)$  as a category  $\mathcal{C}$  which is equipped with a tensor product  $\otimes : \mathcal{C} \times \mathcal{C} \rightarrow \mathcal{C}$  satisfying associativity constraint  $a$ , left unit constraint  $l$  and right unit constraint  $r$  with respect to  $I$ , such that Pentagon Axiom and Triangle Axiom are satisfied.

The definition of a tensor functor  $F : \mathcal{C} \rightarrow \mathcal{D}$  involves also additional isomorphisms.  $\phi_0 : I \rightarrow F(I)$  satisfies commutative diagrams involving right and left unit constraints  $l$  and  $r$ . The family of isomorphisms

$$\phi_2(U, V) : F(U) \otimes F(V) \rightarrow F(U \otimes V)$$

satisfies a commutative diagram stating that  $\phi_2$  commutes with associativity constraints. The interested reader can consult [?] for details. One can also define the notions of natural tensor transformation, natural tensor isomorphism, and tensor equivalence between tensor categories by applying the general category theoretical tools.

Keeping track of associativity isomorphisms is obviously a rather heavy burden. Fortunately, it can be shown that one can assign to a tensor category  $\mathcal{C}$  a strictly associative (or briefly, strict) tensor category which is tensor equivalent of  $\mathcal{C}$ .

### Braided tensor categories

Braided tensor categories satisfy also commutativity constraint  $c$  besides associativity constraint  $a$ . Denote by  $\tau : \mathcal{C} \times \mathcal{C} \rightarrow \mathcal{C} \times \mathcal{C}$  the flip functor defined by  $\tau(V, W) = (W, V)$ . Commutativity constraint is a natural isomorphism

$$c : \otimes \rightarrow \otimes \tau .$$

This means that for any pair  $(V, W)$  of objects there exists isomorphism

$$c_{V,W} : V \otimes W \rightarrow W \otimes V$$

such that the square

$$\begin{array}{ccc}
 V \otimes W & \xrightarrow{c_{V,W}} & W \otimes V \\
 \downarrow f \otimes g & & \downarrow g \otimes f \\
 V' \otimes W' & \xrightarrow{c_{V',W'}} & W' \otimes V'
 \end{array} \tag{A-2.40}$$

commutes.

The commutativity constraint satisfies Hexagon Axiom if the two hexagonal diagrams



(H1)

$$\begin{array}{ccc}
U \otimes (V \otimes W) & \xrightarrow{c_{U,V \otimes W}} & (V \otimes W) \otimes U \\
a_{U,V,W} \nearrow & & \searrow a_{V,W,U} \\
(U \otimes V) \otimes W & & V \otimes (W \otimes U) \\
c_{U,V} \otimes id_W \searrow & id_V \otimes c_{U,W} \nearrow & \\
(V \otimes U) \otimes W & \xrightarrow{a_{V,U,W}} & V \otimes (U \otimes W)
\end{array} \tag{A-2.41}$$

and (H2)

$$\begin{array}{ccc}
(U \otimes V) \otimes W & \xrightarrow{c_{U \otimes V,W}} & W \otimes (U \otimes V) \\
a_{U,V,W}^{-1} \nearrow & & \searrow a_{W,U,V}^{-1} \\
U \otimes (V \otimes W) & & (W \otimes U) \otimes V \\
id_U \otimes c_{V,W} \searrow & c_{U,W} \otimes id_V \nearrow & \\
U \otimes (W \otimes V) & \xrightarrow{a_{U,W,V}^{-1}} & (U \otimes W) \otimes V
\end{array} \tag{A-2.42}$$

commute.

The braiding operation  $c_{V,W}$  and the association operation  $a(U, V, W)$ , and pentagon and hexagon axioms are illustrated in the figure A-2.3 below.

### Duality and tensor categories

The notion of a dual of the finite-dimensional vector space as a space of linear maps from  $V$  to field  $k$  can be lifted to a concept applying for tensor category. A strict (strictly associative) tensor category  $(\mathcal{C}, \otimes, I)$  with unit object  $I$  is said to possess left duality if for each object  $V$  of  $\mathcal{C}$  there exists an object  $V^*$  and morphisms

$$b_V : I \rightarrow V \otimes V^* \quad \text{and} \quad d_V : V^* \otimes V \rightarrow I$$

such that

$$(id \otimes d_V)(b_V \otimes id_V) = id_V \quad \text{and} \quad (d_V \otimes id_{V^*})(id_{V^*} \otimes b_V) = id_{V^*} . \tag{A-2.43}$$

One can define the transpose of  $f$  in terms of  $b_V$  and  $d_V$ . The idea how this is achieved is obvious from figure A-2.3.

$$f^* = (d_V \otimes id_{U^*})(id_{V^*} \otimes f \otimes id_{U^*})(id_{V^*} \otimes b_U) . \tag{A-2.44}$$

Also the braiding operation  $c_{V^*,W}$  can be expressed in terms of  $c_{V,W}^{-1}$ ,  $b_V$  and  $d_V$  by using the isotopy of Fig. A-2.3:

$$c_{V^*,W} = (d_V \otimes id_{W \otimes V^*})(id_{V^*} \otimes c_{V,W}^{-1} \otimes id_{V^*})(id_{V^*} \otimes W \otimes b_V) . \tag{A-2.45}$$

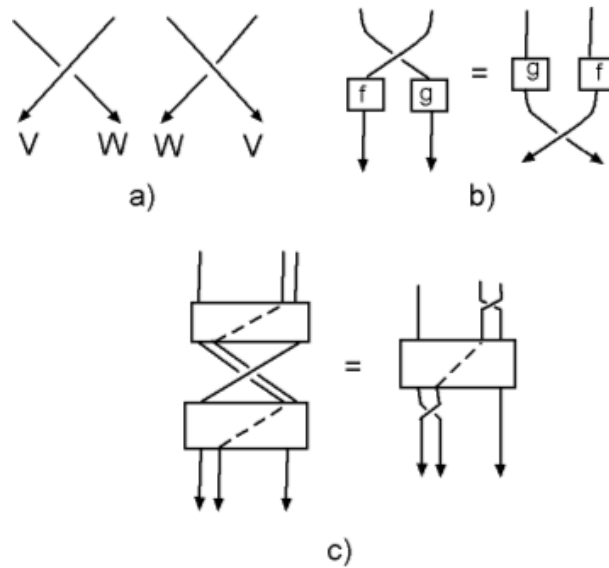

Figure 9: Graphical representations a) of the braiding morphism  $c_{V,W}$  and its inverse  $c_{V,W}^{-1}$ , b) of naturality of  $c_{V,W}$ , c) of First Hexagon Axiom.

Drinfeld quantum double can be regarded as a tensor product of Hopf algebra and its dual and in this case one can introduce morphisms  $ev_H : H \otimes H^* \rightarrow k$  defined as  $e^i \otimes e_j \rightarrow \delta_j^i$  defining inner product and its inverse  $\delta : k \rightarrow H \otimes H$  defined as  $1 \rightarrow e^i e_i$ , where summation over  $i$  is understood. For categories these morphisms are generalized to morphism  $d_V$  from objects  $V$  of category to unit object  $I$  and  $b_V$  from  $I$  to object of category. The elements of  $H$  and  $H^*$  are described as strands with opposite directions, whereas  $d_V$  and  $b_V$  correspond to annihilation and creation of strand–anti-strand pair as show in figure A-2.3.

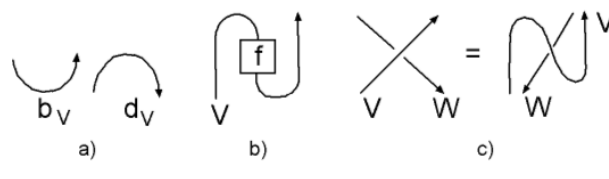

Figure 10: Graphical representations a) of the morphisms  $b_V$  and  $d_V$ , b) of the transpose  $f^*$ , c) of braiding operation  $c_{V^*,W}$  expressed in terms of  $c_{V,W}$ .

**Ribbon categories**

According to the definition of [?] ribbon category is a strict braided tensor category  $(\mathcal{C}, \otimes, I)$  with a left duality with a family of natural morphisms  $\theta_V : V \rightarrow V$  indexed by the objects  $V$  of  $\mathcal{C}$  satisfying the conditions

$$\begin{aligned} \theta_{V \otimes W} &= \theta_V \otimes \theta_W c_{W,V} c_{V,W} \text{ ,} \\ \theta_{V^*} &= (\theta_V)^* \end{aligned} \tag{A-2.46}$$

for all objects  $V, W$  of  $\mathcal{C}$ . The naturality of twist means for for any morphisms  $f : V \rightarrow W$  one has  $\theta_W f = f \theta_V$ . The graphical representation for the axioms and is in Fig. A-2.3.

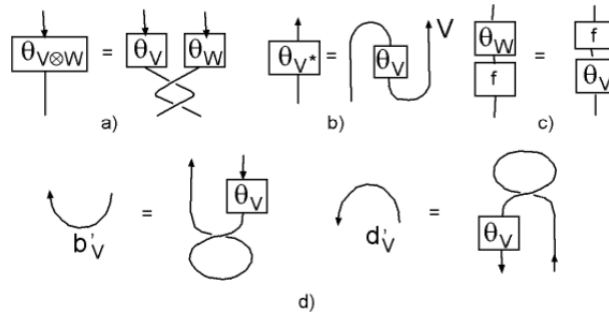

Figure 11: Graphical representations a) of  $\theta_{V \otimes W} = \theta_V \otimes \theta_W c_{W,V} c_{V,W}$ , b) of  $\theta_{V^*} = (\theta_V)^*$ , c) of  $\theta_W f = f \theta_V$ , d) of right duality for a ribbon category.

The existence of the twist operation provides  $\mathcal{C}$  with right duality necessary in order to define trace (see Fig. A-2.3).

$$\begin{aligned} d'_V &= (id_{V^*} \otimes \theta_V) c_{V,V^*} b_V , \\ b'_V &= d_V c_{V,V^*} (\theta_V \otimes id_{V^*}) . \end{aligned} \tag{A-2.47}$$

One can define quantum trace for any endomorphisms  $f$  of ribbon category:

$$tr_q(f) = d'_V (f \otimes id_{V^*}) b_V = d_V c_{V,V^*} (\theta_V f \otimes id_{V^*}) b_V . \tag{A-2.48}$$

Again the graphical representation is the best manner to understand the definition, see figure A-2.3. Quantum trace has the basic properties of trace:  $tr_q(fg) = tr_q(gf)$ ,  $tr_q(f \otimes g) = tr_q(f)tr_q(g)$ ,  $tr_q(f) = tr_q(f^*)$ . The proof of these properties is easiest using isotropy principle.

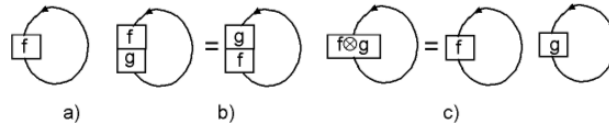

Figure 12: Graphical representations of a)  $tr_q(f)$ , b) of  $tr_q(fg) = tr_q(gf)$ , c) of  $tr(f \otimes g) = tr(f)tr(g)$ .

The quantum dimension of an object  $V$  of ribbon category can be defined as the quantum trace for the identity morphism of  $V$ :  $dim_q(V) = tr_q(id_V) = d'_V b_V$ . Quantum dimension is represented as a vacuum bubble. Quantum dimension satisfies the conditions  $dim_q(V \otimes W) = dim_q(V)dim_q(W)$  and  $dim_q(V) = dim_q(V^*)$ .

A more general definition of ribbon category inspired by the considerations of [?] is obtained by allowing the generalization of morphisms  $\mu$  and  $\Delta$  so that they become morphisms  $\mu_{A \otimes B \rightarrow C}$  and  $\Delta_{C \rightarrow A \otimes B}$  of ribbon category. Graphically the general morphism with arbitrary number of incoming outgoing strands can be represented as a box or "coupon". An important special case of ribbon categories consists of modules over braided Hopf algebras allowing ribbon algebra structure.

### A-3 Axiomatic approach to S-matrix based on the notion of quantum category

This section can be regarded as an attempt of a physicists with some good intuitions and intentions but rather poor algebraic skills to formulate basic axioms about S-matrix in terms of what might be

called quantum category. The basic result is an interpretation for the equivalence of loop diagrams with tree diagrams as a consequence of basic algebra and co-algebra axioms generalized to the level of tensor category. The notion of quantum category emerges naturally as a generalization of ribbon category, when algebra product and co-algebra product are interpreted as morphisms between different objects of the ribbon category.

The general picture suggest that the operations  $\Delta$  and  $\mu$  generalized to algebra homomorphisms  $A \rightarrow B \otimes C$  and  $A \otimes B \rightarrow C$  in a tensor category whose objects are either representations of an algebra or even algebras might provide an appropriate mathematical tool for saying something interesting about S-matrix in TGD Universe. These algebras need not necessarily be bi-algebras. In the following it is demonstrated that the equivalence of loop diagrams to tree diagrams follows from suitably generalized bi-algebra axioms. Also the interpretation of various morphisms involved with Hopf algebra structure is discussed.

### A-3.1 $\Delta$ and $\mu$ and the axioms eliminating loops

The first task is to find a physical interpretation for the basic algebraic operations and how the basic algebra axioms might allow to eliminate loops. The physical interpretation of morphisms  $\Delta$  and  $\mu$  as algebra or category morphisms has been already discussed. As already found, the condition that  $\Delta$  ( $\mu$ ) acts as an algebra (co-algebra) morphism leads to a condition stating that a box graph for 2-particle scattering is equivalent with tree graph. It is interesting to identify the corresponding conditions in the case of self energy loops and vertex corrections.

The condition

$$\mu_{B \otimes C \rightarrow A} \circ \Delta_{A \rightarrow B \otimes C} = K \times id_A , \tag{A-3.1}$$

where  $K$  is a numerical factor, is a natural additional condition stating that a line with a self energy loop is equivalent with a line without the loop. The condition is illustrate in figure A-3.1. For the co-commutative tensor algebra  $T(V)$  of vector space with  $\Delta(x) = 1 \otimes x + x \otimes 1$  one would have  $K = 2$  for the generators of  $T(V)$ . For a product of  $n$  generators one has  $K = 2^n$ .

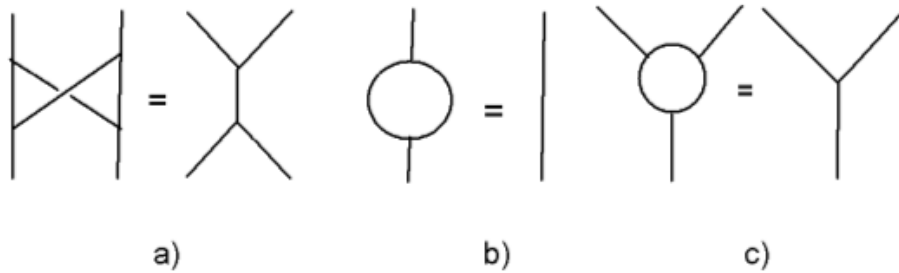

Figure 13: Graphical representations for the conditions a)  $(id \otimes \mu \otimes id)(\Delta \otimes \Delta) = \Delta \circ \mu$ , b)  $\mu_{B \otimes C \rightarrow A} \circ \Delta_{A \rightarrow B \otimes C} = K \times id_A$ , and c)  $(\mu \otimes id) \circ (\Delta \otimes id) \circ \Delta = K \times \Delta$ .

The condition  $\Delta_{A \rightarrow B \otimes C} \circ \mu_{B \otimes C \rightarrow A} = K \times id_A$  cannot hold true since multiplication is not an irreversible process. If this were the case one could reduce tree diagrams to collections of free propagator lines.

In quantum field theories also vertex corrections are a source of divergences. The requirement that the graph representing a vertex correction is equivalent with a simple tree graph representing a decay gives an additional algebraic condition. For bi-algebras the condition would read

$$(\mu \otimes id) \circ (\Delta \otimes id) \circ \Delta = K \Delta , \tag{A-3.2}$$

where  $K$  is a simple multiplicative factor. In fact, for the co-commutative tensor algebra  $T(V)$  of vector space the left hand side would be  $3 \times \Delta(x)$  giving  $K = 3$  for generators  $T(V)$ . The condition is illustrated in figure A-3.1.

Using the standard formulas of appendix for quantum groups one finds that in the case of  $U_q(sl(2))$  the condition  $\mu \circ \Delta(X) = K_X X$ ,  $K_X$  constant, is not true in general. Rather, one has  $\mu \circ \Delta(X) = X K_X (q^{H/2} + q^{-H/2}, q^{1/2}, q^{-1/2})$ . The action on the vacuum state is however proportional to that of  $X$ , being given by  $K_X(2, 1, 1)X$ . The function  $K_X$  for a given  $X$  can be deduced from  $\mu \circ \Delta(X_{\pm}) = q^{H/2} X_{\pm} + X_{\pm} q^{-H/2} = X_{\pm} (q^{\pm 1/2} + q^{H/2} + q^{-H/2})$ . The eigen states of Cartan algebra generators are expected to be eigen states of  $\mu \circ \Delta$  also in the case of a general quantum group.  $\mu \circ \Delta$  is analogous to a single particle operator like kinetic energy and its action on multi-particle state is a sum over all tensor factors with  $\mu \circ \Delta$  applied to each of them. For eigen states of  $\mu \circ \Delta$  the projective equivalence of loop diagrams with tree diagrams would make sense.

Since self energy loops, vertex corrections, and box diagrams represent the basic divergences of renormalizable quantum field theories, these axioms raise the hope that the basic infinities of quantum field theories could be eliminated by the basic axioms for the morphisms of quantum category.

There are also morphisms related to the topology changes in which the 3-surface remains connected. For instance, processes in which the number of boundary components can change could be of special relevance if the family replication phenomenon reduces to the boundary topology. Also 3-topology can change. The experience with topological quantum field theories [?], stimulates the hope that the braid group representations of the topological invariants of 3-topology might be of help in the construction of S-matrix.

The equivalence of loop diagrams with tree diagrams must have algebraic formulation using the language of standard quantum field theory. In the third section it was indeed found that thanks to the presence of the emission of vacuons, the equivalence of loop diagrams with tree diagrams corresponds to the vanishing of loop corrections in the standard quantum field theory framework. Furthermore, the non-cocommutative Hopf algebra of Feynman diagrams discussed in [?] becomes co-commutative when the loop corrections vanish so that TGD program indeed has an elegant algebraic formulation also in the standard framework.

**A-3.2 The physical interpretation of non-trivial braiding and quasi-associativity**

The exchange of the tensor factors by braiding could also correspond to a physically non-trivial but unitary operation as it indeed does in anyon physics [D16, D23]. What would differentiate between elementary particles and anyons would be the non-triviality of the super-canonical and Super Kac-Moody conformal central extensions which have the same origin (addition of a multiplication by a multiple of the Hamiltonian of a canonical transformation to the action of isometry generator). The proposed interpretation of braiding acting in the complex plane in which the conformal weights of the elements of the super-canonical algebra represent punctures justifies the non-triviality. Hexagon Axioms would state that two generalized Feynman diagrams involving exchanges, dissociations and re-associations are equivalent.

An interesting question is whether the association  $(A, B) \rightarrow (A \otimes B)$  could be interpreted as a formation of bound state entanglement between  $A$  and  $B$ . A possible space-time correlate for association is topological condensation of  $A$  and  $B$  to the same space-time sheet. Association would be trivial if all particles are at same space-time sheet  $X^4$  but non-trivial if some subset of particles condense at an intermediate space-time sheet  $Y^4$  condensing in turn at  $X^4$ .

Be as it may, association isomorphisms  $a_{A,B,C}$  would state that the state space obtained by binding  $A$  with bound bound states  $(B \otimes C)$  is unitarily related with the state space obtained by binding  $(A \otimes B)$  bound states with  $C$ . With this interpretation Pentagon axiom would state that two generalized Feynman diagrams depicted in figure A-2.3 leading from initial to final to final state by dissociation and reassociation are equivalent.

**A-3.3 Generalizing the notion of bi-algebra structures at the level of configuration space**

Configuration space of 3-surfaces decomposes into sectors corresponding to different 3-topologies. Also other signatures might be involved and I have proposed that the sectors are characterized by the collection of p-adic primes labelling space-time sheets of the 3-surface and that a given space-time surface could be characterized by an infinite prime or integer. The general problem is to continue various geometric structures from a given sector  $A$  of configuration space to other sector  $B$ .

An especially interesting special case corresponds to a continuation from 1-particle sector to two-particle sector or vice versa and corresponds to TGD variant of 3-vertex. All these continuations involve the imbedding of a structure associated with the sector  $A$  to a structure associated with sector  $B$ . For the continuation from 1-particle sector to 2-particle sector the map is analogous to co-algebra homomorphism  $\Delta$ . For the reverse continuation it is analogous to the algebra product  $\mu$ . Now however one does not have maps  $\Delta : A \rightarrow A \otimes A$  and  $\mu : A \otimes A \rightarrow A$  but  $\Delta : A \rightarrow B \otimes C$  and  $\mu : B \otimes C \rightarrow A$  unless the algebras are isomorphic.  $\mu \circ \Delta = id$  should hold true as an additional condition but  $\Delta \circ \mu = id$  cannot hold true since product maps many pairs to the same element.

### Continuation of the configuration space spinor structure

The basic example of a structure to be continued is configuration space spinor structure. Configuration space spinor fields in different sectors should be related to each other. The isometry generators and gamma matrices of configuration space span a super-canonical algebra. The continuation requires that the super algebra basis of different sectors are related. Also vacua must be related. Isometry generators correspond to bosonic generators of the super-canonical algebra. There is also a natural extension of the super-canonical algebra defined by the Poisson structure of the configuration space.

This view suggests that in the first approximation one could see the construction of S-matrix as following process.

1. Incoming/outgoing states correspond to positive/negative energy states localized to the sectors of configuration space with fixed 3-topologies.
2. In order to construct an S-matrix matrix element between two states localized in sectors A and B, one must continue the state localized in A to B or vice versa and calculate overlap. The continuation involves a sequence of morphisms mapping various structures between sectors. In particular, topological transformations describing particle decay and fusion are possible so that the analogs of product  $\mu$  and co-product  $\Delta$  are involved. The construction of three-manifold topological invariants [?] in topological quantum field theories provides concrete ideas about how to proceed.
3. The S-matrix element describing a particular transition can be expressed as any path leading from the sector A to B or vice versa. There is a huge symmetry very much analogous to the independence of the final result of the analytic continuation on the path chosen since generalized Feynman graphs allow all moves changing intermediate topologies so that initial and final 3-topologies are same. Generalized conformal invariance probably also poses restrictions on possible paths of continuation. In the path integral approach one would have simply sum over all these equivalent paths and thus encounter the fundamental difficulties related to the infinite-dimensional integration.
4. Quantum classical correspondence suggests that the continuation operation has a space-time correlate. That is, the absolute minimum of Kähler action going through the initial and final 3-sheets defines a sequence of transitions changing the topology of 3-sheet. The localization to a particular sector of course selects particular absolute minimum. There are two possible interpretations. Either the continuation from  $A$  is not possible to all possible sectors but only to those with 3-topologies appearing in  $X^4$ , or the absolute minimum represents some kind of minimal continuation involving minimum amount of calculational labor.
5. Quantum classical correspondence and the possibility to represent the rows of S-matrix as zero energy quantum states suggests that the paths for continuation can be also represented at the space-time level, perhaps in terms of braided join along boundaries bonds connecting two light like 3-surfaces representing the initial and final states of particle reaction. Since light like 3-surfaces are metrically two-dimensional and allow conformal invariance, this suggests a connection with braid diagrams in the sense that it should be possible to regard the paths connecting sectors of configuration space consisting of unions of disjoint 3-surfaces (corresponding interacting 4-surfaces are connected) as generalized braids for which also decay and fusion for the strands of braid are possible. Quantum algebra structure and effective metric 2-dimensionality of the light like 3-surfaces suggests different braidings for join along boundaries bonds connecting boundaries of 3-surfaces define non-equivalent 3-surfaces.

**Co-multiplication and second quantized induced spinor fields**

At the microscopic level the construction of S-matrix reduces to understanding what happens for the classical spinor fields in a vertex, which corresponds to an incoming 3-surface A decaying to two outgoing 3-surfaces B and C. At the classical level incoming spinor field A develops into a spinor fields B and C expressible as linear combinations of appropriate spinor basis. At quantum level one must understand how the Fock space defined by the incoming spinor fields of A is mapped to the tensor product of Fock spaces of B and C. The idea about the possible importance of co-algebras came with the realization that this mapping is obviously is very much like a co-product. Co-algebras and bi-algebras possessing both algebra and co-algebra structure indeed suggest a general approach giving hopes of understanding how Feynman diagrammatics generalizes to TGD framework.

The first guess is that fermionic oscillator operators are mapped by the imbedding  $\Delta$  to a superposition of operators  $a_{Bn}^\dagger \otimes Id_C$  and  $Id_B \otimes a_{Cn}^\dagger$  with obvious formulas for Hermitian conjugates.  $\Delta$  induces the mapping of higher Fock states and the construction of S-matrix should reduce to the construction of this map.

$\Delta$  is analogous to the definition for co-product operation although there is also an obvious difference due to the fact that  $\Delta$  imbeds algebra  $A$  to  $B \otimes C$  rather than to  $A \otimes A$ . Only in the case that the algebras are isomorphic, the situation reduces to that for Hopf algebras. Category theoretical approach however allows to consider a more general situation in which  $\Delta$  is a morphism in the category of Fock algebras associated with 3-surfaces.

$\Delta$  preserves fermion number and should respect Fock algebra structure, in particular commute with the anti-commutation relations of fermionic oscillator operators. The basis of fermionic oscillator operators would naturally correspond to fermionic super-canonical generators in turn defining configuration space gamma matrices.

Since any leg can be regarded as incoming leg, strong consistency conditions result on the coefficients in the expression

$$\Delta(a_{An}^\dagger) = C(A, B)_n^m a_{Bm}^\dagger \otimes Id_C + C(A, C)_n^m Id_B \otimes a_{Cm}^\dagger \tag{A-3.3}$$

by forming the cyclic permutations in  $A, B, C$ . This option corresponds to the co-commutative situation and quantum group structure. If identity matrices are replaced with something more general, co-product becomes non-cocommutative.

**A-3.4 Ribbon category as a fundamental structure?**

There exists a generalization of the braided tensor category inspired by the axiomatic approach to topological quantum field theories which seems to almost catch the proposed mathematical requirements. This category is also called ribbon [?] [?] but in more general sense than it is defined in [?].

One adds to the tangle diagrams (braid diagrams with both directions of strands and possibility of strand-anti-strand annihilation) also "coupons", which are boxes representing morphisms with arbitrary numbers of incoming and outgoing strands. As a special case 3-particle vertices are obtained. The strands correspond to representations of a fixed Hopf algebra  $H$ .

In the recent case it would seem safest to postulate that strands correspond to algebras, which can be different because of the potential dependence of the details of Fock algebra on 3-topology and other properties of 3-surface. For instance, configuration space metric defined by anti-commutators of the gamma matrices is degenerate for vacuum extremals so that the infinite Clifford algebra is definitely "smaller" than for surfaces with  $D \geq 3$ -dimensional  $CP_2$  projection.

One might feel that the full ribbon algebra is an un-necessary luxury since only 3-particle vertices are needed since higher vertices describing decays of 3-surfaces can be decomposed to 3-vertices in the generic case. On the other hand, many-sheeted space-time and p-adic fractality suggest that coupons with arbitrary number of incoming and outgoing strands are needed in order to obtain the p-adic hierarchy of length scale dependent theories.

The situation would be the same as in the effective quantum field theories involving arbitrarily high vertices and would require what might be called universal algebra allowing n-ary multiplications and co-multiplications rather than only binary ones. Also strands within strands hierarchy is strongly suggestive and would require a fractal generalization of the ribbon algebra. Note that associativity and

commutativity conditions for morphisms which more than three incoming and outgoing lines would force to generalize the notion of R-matrix and would bring in conditions stating that more complex loop diagrams are equivalent with tree diagrams.

### A-3.5 Minimal models and TGD

Quaternion conformal invariance with non-vanishing  $c$  and  $k$  for anyons is highly attractive option and minimal super-conformal field theories attractive candidate since they describe critical systems and TGD Universe is indeed a quantum critical system.

#### Rational conformal field theories and TGD

The highest weight representations of Virasoro algebra are known as Verma modules containing besides the ground state with conformal weight  $\Delta$  the states generated by Virasoro generators  $L_n$ ,  $n \geq 0$ . For some values of  $\Delta$  Verma module contains states with conformal weight  $\Delta + l$  annihilated by Virasoro generators  $L_n$ ,  $n \geq 1$ . In this case the number of primary fields is reduced since Virasoro algebra acts as a gauge algebra. The conformal weights  $\Delta$  of the Verma modules allowing null states are given by the Kac formula

$$\Delta_{mm'} = \Delta_0 + \frac{1}{4}(\alpha_+ m + \alpha_- m')^2, \quad m, m' \in \{1, 2, \dots\}, \quad (\text{A-3.4})$$

$$\begin{aligned} \Delta_0 &= \frac{1}{24}(c-1), \\ \alpha_{\pm} &= \frac{\sqrt{1-c} \pm \sqrt{25-c}}{\sqrt{24}}. \end{aligned} \quad (\text{A-3.5})$$

The descendants  $\prod_{n \geq 1} L_n^{k_n} |\Delta\rangle$  annihilated by  $L_n$ ,  $n > 0$ , have conformal weights at level  $l = \sum_n n k_n = mm'$ .

In the general case the operator products of primary fields satisfying these conditions form an algebra spanned by infinitely many primary fields. The situation changes if the central charge  $c$  satisfies the condition

$$c = 1 - \frac{6(p'-p)^2}{pp'}, \quad (\text{A-3.6})$$

where  $p$  and  $p'$  are mutually prime positive integers satisfying  $p < p'$ . In this case the Kac weights are rational

$$\Delta_{m,m'} = \frac{(mp' - m'p)^2 - (p' - p)^2}{4pp'}, \quad 0 < m < p, \quad 0 < m' < p'. \quad (\text{A-3.7})$$

Obviously, the number of primary fields is finite. This option does not seem to be realistic in TGD framework were super-conformal invariance is realized.

For  $N = 1$  super-conformal invariance the unitary representations have central extension and conformal weights given by

$$\begin{aligned} c &= \frac{3}{2} \left(1 - \frac{8}{m(m+2)}\right), \\ \Delta_{p,q}(NS) &= \frac{[(m+2)p - mq]^2 - 4}{8m(m+2)}, \quad 0 \leq p \leq m, \quad 1 \leq q \leq m+2. \end{aligned} \quad (\text{A-3.8})$$

For Ramond representations the conformal weights are



$$\Delta_{p,q}(R) = \Delta(NS) + \frac{1}{16} . \tag{A-3.9}$$

The states with vanishing conformal weights correspond to light elementary particles and the states with  $p = q$  have vanishing conformal weight in NS sector. Also this option is non-realistic since in TGD framework super-generators carry fermion number so that  $G$  cannot be a Hermitian operator.

$N = 2$  super-conformal algebra is the most interesting one from TGD point of view since it involves also a bosonic  $U(1)$  charge identifiable as fermion number and  $G^\pm(z)$  indeed carry  $U(1)$  charge<sup>1</sup>. Hence one has  $N = 2$  super-conformal algebra is generated by the energy momentum tensor  $T(z)$ ,  $U(1)$  current  $J(z)$ , and super generators  $G^\pm(z)$ .  $U(1)$  current would correspond to fermion number and super generators would involve contraction of covariantly constant neutrino spinor with second quantized induced spinor field. The further facts that  $N = 2$  algebra is associated naturally with Kähler geometry, that the partition functions associated with  $N = 2$  super-conformal representations are modular invariant, and that  $N = 2$  algebra defines so called chiral ring defining a topological quantum field theory [?], lend further support for the belief that  $N = 2$  super-conformal algebra acts in super-canonical degrees of freedom.

The values of  $c$  and conformal weights for  $N = 2$  super-conformal field theories are given by

$$\begin{aligned} c &= \frac{3k}{k+2} , \\ \Delta_{l,m}(NS) &= \frac{l(l+2) - m^2}{4(k+2)} , \quad l = 0, 1, \dots, k , \\ q_m &= \frac{m}{k+2} , \quad m = -l, -l+2, \dots, l-2, l . \end{aligned} \tag{A-3.10}$$

$q_m$  is the fractional value of the  $U(1)$  charge, which would now correspond to a fractional fermion number. For  $k = 1$  one would have  $q = 0, 1/3, -1/3$ , which brings in mind anyons.  $\Delta_{l=0,m=0} = 0$  state would correspond to a massless state with a vanishing fermion number. Note that  $SU(2)_k$  Wess-Zumino model has the same value of  $c$  but different conformal weights. More information about conformal algebras can be found from the appendix of [?].

For Ramond representation  $L_0 - c/24$  or equivalently  $G_0$  must annihilate the massless states. This occurs for  $\Delta = c/24$  giving the condition  $k = 2 [l(l+2) - m^2]$  (note that  $k$  must be even and that  $(k, l, m) = (4, 1, 1)$  is the simplest non-trivial solution to the condition). Note the appearance of a fractional vacuum fermion number  $q_{vac} = \pm c/12 = \pm k/4(k+2)$ . I have proposed that NS and Ramond algebras could combine to a larger algebra containing also lepto-quark type generators.

Quaternion conformal invariance [K15] encourages to consider the possibility of super-symmetrizing also spin and electro-weak spin of fermions. In this case the conformal algebra would extend to a direct sum of Ramond and NS  $N = 8$  algebras associated with quarks and leptons. This algebra in turn extends to a larger algebra if lepto-quark generators acting as half odd-integer Virasoro generators are allowed. The algebra would contain spin and electro-weak spin as fermionic indices. Poincare and color Kac-Moody generators would act as symplectically extended isometry generators on configuration space Hamiltonians expressible in terms of Hamiltonians of  $X^3_l \times CP_2$ . Electro-weak and color Kac-Moody currents have conformal weight  $h = 1$  whereas  $T$  and  $G$  have conformal weights  $h = 2$  and  $h = 3/2$ .

The experience with  $N = 4$  super-conformal invariance suggests that the extended algebra requires the inclusion of also second quantized induced spinor fields with  $h = 1/2$  and their super-partners with  $h = 0$  and realized as fermion-antifermion bilinears. Since  $G$  and  $\Psi$  are labelled by  $2 \times 4$  spinor indices, super-partners would correspond to  $2 \times (3 + 1) = 8$  massless electro-weak gauge boson states with polarization included. Their inclusion would make the theory highly predictive since induced spinor and electro-weak fields are the fundamental fields in TGD.

In TGD framework both quark and lepton numbers correspond to NS and Ramond type representations, which in conformal field theories can be assigned to the topologies of complex plane and cylinder. This would suggest that a given three-surface allows either NS or Ramond representation

---

<sup>1</sup>I realized that TGD super-conformal algebra corresponds to  $N = 2$  algebra while writing this and proposed it earlier as a generalization of super-conformal algebra!

and is either leptonic or quark like but one must be very cautious with this kind of conclusion. Interestingly, NS and Ramond type representations allow a symmetry acting as a spectral flow in the indices of the generators and transforming NS and Ramond type representations continuously to each other [?]. The flow acts as

$$\begin{aligned} L_n &\rightarrow L_n + \alpha J_n + \frac{c}{6} \alpha^2 \delta_{n,0} \\ J_n &\rightarrow J_n + \frac{c}{3} \alpha \delta_{n,0} \ , \\ G_n^\pm &\rightarrow G_{n \pm \alpha}^\pm \ . \end{aligned} \tag{A-3.11}$$

The choice  $\alpha = \pm 1/2$  transforms NS representation to Ramond representation. The idea that leptons could be transformed to quarks in a continuous manner does not sound attractive in TGD framework. Note that the action of Super Kac-Moody Virasoro algebra in the space of super-canonical conformal weights can be interpreted as a spectral flow.

**Co-product for Super Kac-Moody and Super Virasoro algebras**

By the previous considerations the quantized conformal weights  $z_1, z_2, z_3$  of super-canonical generators defining punctures of 2-surface should correspond to line punctures of 3-surface. One cannot avoid the thought that these line punctures should meet at single point so that three-vertex would have also quantum field theoretical interpretation.

Each point  $z_k$  corresponds to its own Virasoro algebra  $V_k = \{L_n^{z_k}\}$  and Kac-Moody algebra  $J_k = \{J_n^{z_k}\}$  defined by Laurent series of  $T(z)$  and  $J(z)$  at  $z_k$ . Also super-generators are involved. To minimize notational labor denote by  $X_n^{z_k}$ ,  $k = 1, 2, 3$  the generators in question.

The co-algebra product for Super-Virasoro and Super-Kac-Moody involves in the case of fusion  $A_1 \otimes A_2 \rightarrow A_3$  a co-algebra product assigning to the generators  $X_n^{z_3}$  direct sum of generators of  $X_k^{z_1}$  and  $X_l^{z_2}$ . The most straightforward approach is to express the generators  $X_n^{z_3}$  in terms of generators  $X_k^{z_1}$  and  $X_l^{z_2}$ . This is achieved by using the expressions for generators as residy integrals of energy momentum tensor and Kac Moody currents. For Virasoro generators this is carried out explicitly in [?]. The resulting co-product conserves the value of central extension whereas for the naive co-product this would not be the case. Obviously, the geometric co-product does not conserve conformal weight.

**A-4 Some examples of bi-algebras and quantum groups**

The appendix summarizes briefly the simplest bi- and Hopf algebras and some basic constructions related to quantum groups.

**A-4.1 Hecke algebra and Temperley-Lieb algebra**

Braid group is accompanied by several algebras. For Hecke algebra, which is particular case of braid algebra, one has

$$\begin{aligned} e_{n+1} e_n e_{n+1} &= e_n e_{n+1} e_n \ , \\ e_n^2 &= (t - 1) e_n + t \ . \end{aligned} \tag{A-4.1}$$

The algebra reduces to that for symmetric group for  $t = 1$ .

Hecke algebra can be regarded as a discrete analog of Kac Moody algebra or loop algebra with  $G$  replaced by  $S_n$ . This suggests a connection with Kac-Moody algebras and imbedding of Galois groups to Kac-Moody group.  $t = p^n$  corresponds to a finite field. Fractal dimension  $t = \mathcal{M} : \mathcal{N}$  relates naturally to braid group representations: fractal dimension of quantum quaternions might be appropriate interpretation.  $t=1$  gives symmetric group. Infinite braid group could be seen as a quantum variant of Galois group for algebraic closure of rationals.

Temperley-Lieb algebra assignable with Jones inclusions of hyper-finite factors of type  $II_1$  with  $\mathcal{M} : \mathcal{N} < 4$  is given by the relations

$$\begin{aligned} e_{n+1}e_nen + 1 &= e_{n+1} \\ e_n e_{n+1} e_n &= e_n, \\ e_n^2 &= te_n, \quad , t = -\sqrt{\mathcal{M} : \mathcal{N}} = -2\cos(\pi/n), \quad n = 3, 4, \dots \end{aligned} \tag{A-4.2}$$

The conditions involving three generators differ from those for braid group algebra since  $e_n$  are now proportional to projection operators. An alternative form of this algebra is given by

$$\begin{aligned} e_{n+1}e_nen + 1 &= te_{n+1} \\ e_n e_{n+1} e_n &= te_n, \\ e_n^2 &= e_n = e_n^*, \quad , t = -\sqrt{\mathcal{M} : \mathcal{N}} = -2\cos(\pi/n), \quad n = 3, 4, \dots \end{aligned} \tag{A-4.3}$$

This representation reduces to that for Temperley-Lieb algebra with obvious normalization of projection operators. These algebras are somewhat analogous to function fields but the value of coordinate is fixed to some particular values. An analogous discretization for function fields corresponds to a formation of number theoretical braids.

### A-4.2 Simplest bi-algebras

Let  $k(x_1, \dots, x_n)$  denote the free algebra of polynomials in variables  $x_i$  with coefficients in field  $k$ .  $x_i$  can be regarded as points of a set. The algebra  $Hom(k(x_1, \dots, x_n), A)$  of algebra homomorphisms  $k(x_1, \dots, x_n) \rightarrow A$  can be identified as  $A^n$  since by the homomorphism property the images  $f(x_i)$  of the generators  $x_1, \dots, x_n$  determined the homomorphism completely. Any commutative algebra  $A$  can be identified as the  $Hom(k[x], A)$  with a particular homomorphism corresponding to a line in  $A$  determined uniquely by an element of  $A$ .

The matrix algebra  $M(2)$  can be defined as the polynomial algebra  $k(a, b, c, d)$ . Matrix multiplication can be represented universally as an algebra morphism  $\Delta$  from from  $M_2 = k(a, b, c, d)$  to  $M_2^{\otimes 2} = k(a', a'', b', b'', c', c'', d', d'')$  to  $k(a, b, c, d)$  in matrix form as

$$\Delta \begin{pmatrix} a & b \\ c & d \end{pmatrix} = \begin{pmatrix} a' & b' \\ c' & d' \end{pmatrix} \begin{pmatrix} a'' & b'' \\ c'' & d'' \end{pmatrix} .$$

This morphism induces algebra multiplication in the matrix algebra  $M_2(A)$  for any commutative algebra  $A$ .

$M(2)$ ,  $GL(2)$  and  $SL(2)$  provide standard examples about bi-algebras.  $SL(2)$  can be defined as a commutative algebra by dividing free polynomial algebra  $k(a, b, c, d)$  spanned by the generators  $a, b, c, d$  by the ideal  $det - 1 = ad - bc - 1 = 0$  expressing that the determinant of the matrix is one. In the matrix representation  $\mu$  and  $\eta$  are defined in obvious manner and  $\mu$  gives powers of the matrix

$$A = \begin{pmatrix} a & b \\ c & d \end{pmatrix} .$$

$\Delta$ , counit  $\epsilon$ , and antipode  $S$  can be written in case of  $SL(2)$  as

$$\begin{pmatrix} \Delta(a) & \Delta(b) \\ \Delta(c) & \Delta(d) \end{pmatrix} = \begin{pmatrix} a & b \\ c & d \end{pmatrix} \otimes \begin{pmatrix} a & b \\ c & d \end{pmatrix} ,$$

$$\begin{pmatrix} \epsilon(a) & \epsilon(b) \\ \epsilon(c) & \epsilon(d) \end{pmatrix} = \begin{pmatrix} 1 & 0 \\ 0 & 1 \end{pmatrix} .$$

$$S \begin{pmatrix} a & b \\ c & d \end{pmatrix} = (ad - bc)^{-1} \begin{pmatrix} d & -b \\ -c & a \end{pmatrix} .$$

Note that matrix representation is only an economical manner to summarize the action of  $\Delta$  on the generators  $a, b, c, d$  of the algebra. For instance, one has  $\Delta(a) = a \rightarrow a \otimes a + b \otimes c$ . The resulting algebra is both commutative and co-commutative.

$SL(2)_q$  can be defined as a Hopf algebra by dividing the free algebra generated by elements  $a, b, c, d$  by the relations

$$\begin{aligned} ba &= qab \ , & db &= qbd \ , \\ ca &= qac \ , & dc &= qcd \ , \\ bc &= cb \ , & ad - da &= (q^{-1} - 1)bc \ , \end{aligned}$$

and the relation

$$\det_q = ad - q^{-1}bc = 1$$

stating that the quantum determinant of  $SL(2)_q$  matrix is one.

$\mu, \eta, \Delta, \epsilon$  are defined as in the case of  $SL(2)$ . Antipode  $S$  is defined by

$$S \begin{pmatrix} a & b \\ c & d \end{pmatrix} = \det_q^{-1} \begin{pmatrix} d & -qb \\ -q^{-1}c & a \end{pmatrix} .$$

The relations above guarantee that it defines quantum inverse of  $A$ . For  $q$  an  $n^{\text{th}}$  root of unity,  $S^{2n} = id$  holds true which signals that these parameter values are somehow exceptional. This result is completely general.

Given an algebra, the  $R$  point of  $SL_q(2)$  is defined as a four-tuple  $(A, B, C, D)$  in  $R^4$  satisfying the relations defining the point of  $SL_q(2)$ . One can say that  $R$ -points provide representations of the universal quantum algebra  $SL_q(2)$ .

### A-4.3 Quantum group $U_q(sl(2))$

Quantum group  $U_q(sl(2))$  or rather, quantum enveloping algebra of  $sl(2)$ , can be constructed by applying Drinfeld's quantum double construction (to avoid confusion note that the quantum Hopf algebra associated with  $SL(2)$  is the quantum analog of a commutative algebra generated by powers of a  $2 \times 2$  matrix of unit determinant).

The commutation relations of  $sl(2)$  read as

$$[X_+, X_-] = H \ , \quad [H, X_{\pm}] = \pm 2X_{\pm} \ . \quad (\text{A-4.4})$$

$U_q(sl(2))$  allows co-algebra structure given by

$$\begin{aligned} \Delta(J) &= J \otimes 1 + 1 \otimes J \ , & S(J) &= -J \ , & \epsilon(J) &= 0 \ , & J &= X_{\pm}, H \ , \\ S(1) &= 1 \ , & \epsilon(1) &= 1 \ . \end{aligned} \quad (\text{A-4.5})$$

The enveloping algebras of Borel algebras  $U(B_{\pm})$  generated by  $\{1, X_+, H\}$   $\{1, X_-, hH\}$  define the Hopf algebra  $H$  and its dual  $H^*$  in Drinfeld's construction.  $h$  could be called Planck's constant vanishes at the classical limit. Note that  $H^*$  reduces to  $\{1, X_-\}$  at this limit. Quantum deformation parameter  $q$  is given by  $\exp(2h)$ . The duality map  $\star : H \rightarrow H^*$  reads as

$$\begin{aligned} a &\rightarrow a^* \ , & ab &= (ab)^* = b^*a^* \ , \\ 1 &\rightarrow 1 \ , & H &\rightarrow H^* = hH \ , & X_+ &\rightarrow (X_+)^* = hX_- \ . \end{aligned} \quad (\text{A-4.6})$$

The commutation relations of  $U_q(sl(2))$  read as

$$[X_+, X_-] = \frac{q^H - q^{-H}}{q - q^{-1}} \ , \quad [H, X_{\pm}] = \pm 2X_{\pm} \ . \quad (\text{A-4.7})$$

Co-product  $\Delta$ , antipode  $S$ , and co-unit  $\epsilon$  differ from those  $U(sl(2))$  only in the case of  $X_{\pm}$ :

$$\begin{aligned} \Delta(X_{\pm}) &= X_{\pm} \otimes q^{H/2} + q^{-H/2} \otimes X_{\pm} \ , \\ S(X_{\pm}) &= -q^{\pm 1} X_{\pm} \ . \end{aligned} \quad (\text{A-4.8})$$

When  $q$  is not a root of unity, the universal R-matrix is given by

$$R = q^{\frac{H \otimes H}{2}} \sum_{n=0}^{\infty} \frac{(1-q^{-2})^n}{[n]_q!} q^{\frac{n(1-n)}{2}} q^{\frac{nH}{2}} X_+^n \otimes q^{-\frac{nH}{2}} X_-^n . \tag{A-4.9}$$

When  $q$  is  $m$ :th root of unity the  $q$ -factorial  $[n]_q!$  vanishes for  $n \geq m$  and the expansion does not make sense.

For  $q$  not a root of unity the representation theory of quantum groups is essentially the same as of ordinary groups. When  $q$  is  $m^{th}$  root of unity, the situation changes. For  $l = m = 2n$   $n^{th}$  powers of generators span together with the Casimir operator a sub-algebra commuting with the whole algebra providing additional numbers characterizing the representations. For  $l = m = 2n + 1$  same happens for  $m^{th}$  powers of Lie-algebra generators. The generic representations are not fully reducible anymore. In the case of  $U_q(sl(2))$  irreducibility occurs for spins  $n < l$  only. Under certain conditions on  $q$  it is possible to decouple the higher representations from the theory. Physically the reduction of the number of representations to a finite number means a symmetry analogous to a gauge symmetry. The phenomenon resembles the occurrence of null vectors in the case of Virasoro and Kac Moody representations and there indeed is a deep connection between quantum groups and Kac-Moody algebras [?].

One can wonder what is the precise relationship between  $U_q(sl(2))$  and  $SL_q(2)$  which both are quantum groups using loose terminology. The relationship is duality. This means the existence of a morphism  $x \rightarrow \Psi(x) M_q(2) \rightarrow U_q^*$  defined by a bilinear form  $\langle u, x \rangle = \Psi(x)(u)$  on  $U_q \times M_q(2)$ , which is bi-algebra morphism. This means that the conditions

$$\begin{aligned} \langle uv, x \rangle &= \langle u \otimes v, \Delta(x) \rangle , & \langle u, xy \rangle &= \langle \Delta(u), x \otimes y \rangle , \\ \langle 1, x \rangle &= \epsilon(x) , & \langle u, 1 \rangle &= \epsilon(u) \end{aligned}$$

are satisfied. It is enough to find  $\Psi(x)$  for the generators  $x = A, B, C, D$  of  $M_q(2)$  and show that the duality conditions are satisfied. The representation

$$\rho(E) = \begin{pmatrix} 0 & 1 \\ 0 & 0 \end{pmatrix} , \quad \rho(F) = \begin{pmatrix} 0 & 0 \\ 1 & 0 \end{pmatrix} , \quad \rho(K = q^H) = \begin{pmatrix} q & 0 \\ 0 & q^{-1} \end{pmatrix} ,$$

extended to a representation

$$\rho(u) = \begin{pmatrix} A(u) & B(u) \\ C(u) & D(u) \end{pmatrix}$$

of arbitrary element  $u$  of  $U_q(sl(2))$  defines for elements in  $U_q^*$ . It is easy to guess that  $A(u), B(u), C(u), D(u)$ , which can be regarded as elements of  $U_q^*$ , can be regarded also as R points that is images of the generators  $a, b, c, d$  of  $SL_q(2)$  under an algebra morphism  $SL_q(2) \rightarrow U_q^*$ .

### A-4.4 General semisimple quantum group

The Drinfeld's construction of quantum groups applies to arbitrary semi-simple Lie algebra and is discussed in detail in [?]. The construction relies on the use of Cartan matrix.

Quite generally, Cartan matrix  $A = \{a_{ij}\}$  is  $n \times n$  matrix satisfying the following conditions:

- i)  $A$  is indecomposable, that is does not reduce to a direct sum of matrices.
- ii)  $a_{ij} \leq 0$  holds true for  $i < j$ .
- iii)  $a_{ij} = 0$  is equivalent with  $a_{ji} = 0$ .

$A$  can be normalized so that the diagonal components satisfy  $a_{ii} = 2$ .

The generators  $e_i, f_i, k_i$  satisfying the commutations relations

$$\begin{aligned} k_i k_j &= k_j k_i , & k_i e_j &= q_i^{a_{ij}} e_j k_i , \\ k_i f_j &= q_i^{-a_{ij}} e_j k_i , & e_i f_j - f_j e_i &= \delta_{ij} \frac{k_i - k_i^{-1}}{q_i - q_i^{-1}} , \end{aligned} \tag{A-4.10}$$

and so called Serre relations

$$\begin{aligned} \sum_{l=0}^{1-a_{ij}} (-1)^l \begin{bmatrix} 1-a_{ij} \\ l \end{bmatrix} e_i^{1-a_{ij}-l} e_j e_i^l &= 0, \quad i \neq j, \\ \sum_{l=0}^{1-a_{ij}} (-1)^l \begin{bmatrix} 1-a_{ij} \\ l \end{bmatrix}_{q_i} f_i^{1-a_{ij}-l} f_j f_i^l &= 0, \quad i \neq j. \end{aligned} \quad (\text{A-4.11})$$

Here  $q_i = q^{D_i}$  where one has  $D_i a_{ij} = a_{ij} D_i$ .  $D_i = 1$  is the simplest choice in this case. Comultiplication is given by

$$\Delta(k_i) = k_i \otimes k_i, \quad (\text{A-4.12})$$

$$\Delta(e_i) = e_i \otimes k_i + 1 \otimes e_i, \quad (\text{A-4.13})$$

$$\Delta(f_i) = f_i \otimes 1 + k_i^{-1} \otimes 1. \quad (\text{A-4.14})$$

$$(\text{A-4.15})$$

The action of antipode  $S$  is defined as

$$S(e_i) = -e_i k_i^{-1}, \quad S(f_i) = -k_i f_i, \quad S(k_i) = -k_i^{-1}. \quad (\text{A-4.16})$$

### A-4.5 Quantum affine algebras

The construction of Drinfeld and Jimbo generalizes also to the case of untwisted affine Lie algebras, which are in one-one correspondence with semisimple Lie algebras. The representations of quantum deformed affine algebras define corresponding deformations of Kac-Moody algebras. In the following only the basic formulas are summarized and the reader not familiar with the formalism can consult a more detailed treatment can be found in [?].

#### 1. Affine algebras

The Cartan matrix  $A$  is said to be of affine type if the conditions  $\det(A) = 0$  and  $a_{ij} a_{ji} \geq 4$  (no summation) hold true. There always exists a diagonal matrix  $D$  such that  $B = DA$  is symmetric and defines symmetric bilinear degenerate metric on the affine Lie algebra.

The Dynkin diagrams of affine algebra of rank  $l$  have  $l+1$  vertices (so that Cartan matrix has one null eigenvector). The diagrams of semisimple Lie-algebras are sub-diagrams of affine algebras. From the  $(l+1) \times (l+1)$  Cartan matrix of an untwisted affine algebra  $\hat{A}$  one can recover the  $l \times l$  Cartan matrix of  $A$  by dropping away 0:th row and column.

For instance, the algebra  $A_1^1$ , which is affine counterpart of  $SL(2)$ , has Cartan matrix  $a_{ij}$

$$A = \begin{pmatrix} 2 & -2 \\ -2 & 2 \end{pmatrix}$$

with a vanishing determinant.

Quite generally, in untwisted case quantum algebra  $U_q(\hat{\mathcal{G}}_l)$  as  $3(l+1)$  generators  $e_i, f_i, k_i$  ( $i = 0, 1, \dots, l$ ) satisfying the relations of Eq. A-4.11 for Cartan matrix of  $\mathcal{G}^{(1)}$ . Affine quantum group is obtained by adding to  $U_q(\hat{\mathcal{G}}_l)$  a derivation  $d$  satisfying the relations

$$[d, e_i] = \delta_{i0} e_i, \quad [d, f_i] = \delta_{i0} f_i, \quad [d, k_i] = 0. \quad (\text{A-4.17})$$

with comultiplication  $\Delta(d) = d \otimes 1 + 1 \otimes d$ .

#### 2. Kac Moody algebras

The undeformed extension  $\hat{\mathcal{G}}_l$  associated with the affine Cartan matrix  $\mathcal{G}_l^{(1)}$  is the Kac Moody algebra associated with the group  $G$  obtained as the central extension of the corresponding loop algebra. The loop algebra is defined as

$$L(\mathcal{G}) = \mathcal{G} \otimes C[t, t^{-1}], \quad (\text{A-4.18})$$

where  $C[t, t^{-1}]$  is the algebra of Laurent polynomials with complex coefficients. The Lie bracket is

$$[x \times P, y \otimes Q] = [x, y] \otimes PQ \quad . \quad (\text{A-4.19})$$

The non-degenerate bilinear symmetric form  $(,)$  in  $\mathcal{G}_l$  induces corresponding form in  $L(\mathcal{G}_l)$  as  $(x \otimes P, y \otimes Q) = (x, y)PQ$ .

A two-cocycle on  $L(\mathcal{G}_l)$  is defined as

$$\Psi(a, b) = \text{Res}\left(\frac{da}{dt}, b\right) \quad , \quad (\text{A-4.20})$$

where the residue of a Laurent is defined as  $\text{Res}(\sum_n a_n t^n) = a_{-1}$ . The two-cocycle satisfies the conditions

$$\begin{aligned} \Psi(a, b) &= -\Psi(b, a) \quad , \\ \Psi([a, b], c) + \Psi([b, c], a) + \Psi([c, a], b) &= 0 \quad . \end{aligned} \quad (\text{A-4.21})$$

The two-cocycle defines the central extension of loop algebra  $L(\mathcal{G}_l)$  to Kac Moody algebra  $L(\mathcal{G}_l) \otimes Cc$ , where  $c$  is a new central element commuting with the loop algebra. The new bracket is defined as  $[,] + \Psi(, )c$ . The algebra  $\tilde{L}(\mathcal{G}_l)$  is defined by adding the derivation  $d$  which acts as  $td/dt$  measuring the conformal weight.

The standard basis for Kac Moody algebra and corresponding commutation relations are given by

$$\begin{aligned} J_n^x &= x \otimes t^n \quad , \\ [J_n^x, J_m^y] &= J_{n+m}^{[x,y]} + n\delta_{m+n,0}c \quad . \end{aligned} \quad (\text{A-4.22})$$

The finite dimensional irreducible representations of  $G$  defined representations of Kac Moody algebra with a vanishing central extension  $c = 0$ . The highest weight representations are characterized by highest weight vector  $|v\rangle$  such that

$$\begin{aligned} J_n^x |v\rangle &= 0, \quad n > 0 \quad , \\ c |v\rangle &= k |v\rangle \quad . \end{aligned} \quad (\text{A-4.23})$$

### 3. Quantum affine algebras

Drinfeld has constructed the quantum affine extension  $U_q(\mathcal{G}_l)$  using quantum double construction. The construction of generators uses almost the same basic formulas as the construction of semi-simple algebras. The construction involves the automorphism  $D_t : U_q(\tilde{\mathcal{G}}_l) \otimes C[t, t^{-1}] \rightarrow U_q(\tilde{\mathcal{G}}_l) \otimes C[t, t^{-1}]$  given by

$$\begin{aligned} D_t(e_i) &= t^{\delta_{i0}} e_i \quad , \quad D_t(f_i) = t^{\delta_{i0}} f_i \quad , \\ D_t(k_i) &= k_i \quad \quad \quad D_t(d) = d \quad , \end{aligned} \quad (\text{A-4.24})$$

and the co-product

$$\Delta_t(a) = (D_t \otimes 1)\Delta(a) \quad , \quad \Delta_t^{op}(a) = (D_t \otimes 1)\Delta^{op}(a) \quad , \quad (\text{A-4.25})$$

where the  $\Delta(a)$  is the co-product defined by the same general formula as applying in the case of semi-simple Lie algebras. The universal R-matrix is given by

$$\mathcal{R}(t) = (D_t \otimes 1)\mathcal{R} \quad , \quad (\text{A-4.26})$$

and satisfies the equations

$$\begin{aligned}
 \mathcal{R}(t)\Delta_t(a) &= \Delta_t^{op}(a)\mathcal{R} \ , \\
 (\Delta_z \otimes id)\mathcal{R}(u) &= \mathcal{R}_{13}(zu)\mathcal{R}_{23}(u) \ , \\
 (id \otimes \Delta_u)\mathcal{R}(zu) &= \mathcal{R}_{13}(z)\mathcal{R}_{12}(zu) \ , \\
 \mathcal{R}_{12}(t)\mathcal{R}_{13}(tw)\mathcal{R}_{23}(w) &= \mathcal{R}_{23}(w)\mathcal{R}_{13}(tw)\mathcal{R}_{12}(t) \ .
 \end{aligned}
 \tag{A-4.27}$$

The infinite-dimensional representations of affine algebra give representations of Kac-Moody algebra when one restricts the consideration to generations  $e_i, f_i, k_i, i > 0$ .



# Mathematics

- [A1] Gaussian Mersenne. <http://primes.utm.edu/glossary/xpage/GaussianMersenne.html>.
- [A2] Z. I. Borevich and I. R. Shafarevich. *Number Theory*. Academic Press, 1966.
- [A3] Eisenhart. *Riemannian Geometry*. Princeton University Press, 1964.
- [A4] C. N. Pope G. W. Gibbons.  $CP_2$  as gravitational instanton. *Comm. Math. Phys.*, 55, 1977.
- [A5] W. Hawking, S. and N. Pope, C. Generalized Spin Structures in Quantum Gravity. *Phys. Lett.*, (1), 1978.
- [A6] S. Helgason. *Differential Geometry and Symmetric Spaces*. Academic Press, New York, 1962.
- [A7] C. Itzykson and J-B. Zuber. *Quantum Field Theory*, volume 549. Mc Graw-Hill, New York, 1980.
- [A8] J. Milnor. *Topology form Differential Point of View*. The University Press of Virginia, Virginia, 1965.
- [A9] D. S. Moak. The q-analogue of the Laguerre polynomials. *J. Math. Anal. Appl.*, 81, 1981.
- [A10] N. Pope, C. Eigenfunctions and  $Spin^c$  Structures on  $CP_2$ , 1980.
- [A11] B. Shipman. The geometry of momentum mappings on generalized flag manifolds, connections with a dynamical system, quantum mechanics and the dance of honeybee. <http://math.cornell.edu/~oliver/Shipman.gif>, 1998.
- [A12] M. Spivak. *Differential Geometry I,II,III,IV*. Publish or Perish, Boston, 1970.
- [A13] J. Hanson T. Eguchi, B. Gilkey. *Phys. Rep.*, 66:1980, 1980.
- [A14] R. Thom. *Commentarii Math. Helvet.*, 28, 1954.
- [A15] Wallace. *Differential Topology*. W. A. Benjamin, New York, 1968.
- [A16] E. C. Zeeman. *Catastrophe Theory*. Addison-Wessley Publishing Company, 1977.



# Condensed Matter Physics

- [D1] Fractional quantum Hall Effect. [http://en.wikipedia.org/wiki/Fractional\\_quantum\\_Hall\\_effect](http://en.wikipedia.org/wiki/Fractional_quantum_Hall_effect).
- [D2] Hydrogen bonds. [http://en.wikipedia.org/wiki/Hydrogen\\_bond](http://en.wikipedia.org/wiki/Hydrogen_bond).
- [D3] Phase conjugation. <http://www.usc.edu/dept/ee/People/Faculty/feinberg.html>.
- [D4] O. Balcou and L. Durtriaux. *Phys. Rev.*, 78, 1997.
- [D5] J. K. Borhardt. The chemical formula H<sub>2</sub>O - a misnomer. *The Alchemist*, August 2003.
- [D6] M. Chaplin. Water Structure and Behavior. <http://www.lsbu.ac.uk/water/index.html>, 2005.
- [D7] R. Y. Chiao. Super-conductors as transducers and antennas for gravitational and electromagnetic radiation. <http://arxiv.org/abs/gr-gc/0204012>.
- [D8] R. Y. Chiao. Tunnelling Times and Super-luminality: a Tutorial, November 1998.
- [D9] R. Y. Chiao and A. M. Steinberg. In E. Wolf, editor, *Progress in Optics XXXVII*, volume 345, Amsterdam, 1997. Elsevier.
- [D10] R. A. Cowley. Neutron-scattering experiments and quantum entanglement. *Physica B*, 350:243–245, 2004.
- [D11] D. J. Evans et al. Experimental Demonstration of Violations of the Second Law of Thermodynamics for Small Systems and Short Time Scales. *Phys. Rev.*, 89, 2002.
- [D12] G. A. Melkov et al. *Phase Conjugation of Linear and Nonlinear Signals of Magnetostatic Waves*. Trans Tech Publications, Switzerland, 2001.
- [D13] G. Nimtz et al. *J. Phys.*, 4, 1994.
- [D14] J. B. Miller et al. Fractional Quantum Hall effect in a quantum point contact at filling fraction  $5/2$ . <http://arxiv.org/abs/cond-mat/0703161v2>, 2007.
- [D15] R. Mills et al. Spectroscopic and NMR identification of novel hybrid ions in fractional quantum energy states formed by an exothermic reaction of atomic hydrogen with certain catalysts. <http://www.blacklightpower.com/techpapers.html>, 2003.
- [D16] S. M. Girvin. Quantum Hall Effect, Novel Excitations and Broken Symmetries. <http://arxiv.org/abs/cond-mat/9907002>, 1999.
- [D17] J.K. Jain. *Phys. Rev.*, 63, 1989.
- [D18] P. Kanarev. Water is New Source of Energy. *Krasnodar*, 2002.
- [D19] P. Kanarev and T. Mizuno. Cold fusion by plasma electrolysis of water. <http://www.guns.connect.fi/innoplaza/energy/story/Kanarev/codlfusion/>, 2002.
- [D20] I. Langmuir. *Journal of American Chemical Society*, 37, 1915.
- [D21] R. B. Laughlin. *Phys. Rev.*, 50, 1990.

- [D22] J-C. Li and D.K. Ross. Evidence of Two Kinds of Hydrogen Bonds in Ices. *Nature*, 365:327–329, 1993.
- [D23] R. Mackenzie and F. Wilczek. *Rev. Mod. Phys. A*, 3:2827, 1988.
- [D24] S. Meyer. Water Fuel Cell. International News Release, No. 11 A-Rv., 1996.
- [D25] D. M. Pepper. Nonlinear Optical Phase Conjugation. *Optical Engineering*, 21(2), March 1982.
- [D26] H. Puthoff. Ground State of Hydrogen as a Zero-Point Fluctuation Determined State. *Phys. Rev. D*, 35, 1987.
- [D27] Y. Danon R. Moreh, R. C. Block and M. Neumann. Search for anomalous scattering of keV neutrons from H<sub>2</sub>O-D<sub>2</sub>O mixtures. *Phys. Rev.*, 94, 2005.
- [D28] V. V. Shkunov and B. Ya. Zeldovich. Optical Phase Conjugation. *Scientific American*, 1985.
- [D29] D. D. Stancil. *Theory of Magnetostatic Waves*. Springer Verlag, 1993.
- [D30] A. M. Steinberg and R. Y. Chiao. Sub-femtosecond determination of transmission delay times for a dielectric mirror (photonic bandgap) as a function of angle of incidence. <http://arxiv.org/abs/quant-ph/9501013>, 1995.
- [D31] L. Wang. *Nature*, July 2000.
- [D32] Pollack G. Zheng, Jian-ming. Long-range forces extending from polymer-gel surfaces. <http://arxiv.org/abs/cond-mat/0305093>, 2003.

# Books related to TGD

- [K1] M. Pitkänen. 1983.
- [K2] M. Pitkänen. Is it Possible to Understand Coupling Constant Evolution at Space-Time Level? In *Towards M-Matrix*. Onlinebook. [http://tgdtheory.com/public\\_html/tgdquant/tgdquant.html#rgflow](http://tgdtheory.com/public_html/tgdquant/tgdquant.html#rgflow), 2006.
- [K3] M. Pitkänen. About Strange Effects Related to Rotating Magnetic Systems . In *TGD and Fringe Physics*. Onlinebook. [http://tgdtheory.com/public\\_html/freenergy/freenergy.html#Faraday](http://tgdtheory.com/public_html/freenergy/freenergy.html#Faraday), 2006.
- [K4] M. Pitkänen. About the New Physics Behind Qualia. In *Quantum Hardware of Living Matter*. Onlinebook. [http://tgdtheory.com/public\\_html/bioware/bioware.html#newphys](http://tgdtheory.com/public_html/bioware/bioware.html#newphys), 2006.
- [K5] M. Pitkänen. An Overview about Quantum TGD: Part I. In *Topological Geometrodynamics: Overview*. Onlinebook. [http://tgdtheory.com/public\\_html/tgdview/tgdview.html#evoII](http://tgdtheory.com/public_html/tgdview/tgdview.html#evoII), 2006.
- [K6] M. Pitkänen. An Overview about the Evolution of Quantum TGD. In *Topological Geometrodynamics: Overview*. Onlinebook. [http://tgdtheory.com/public\\_html/tgdview/tgdview.html#evoI](http://tgdtheory.com/public_html/tgdview/tgdview.html#evoI), 2006.
- [K7] M. Pitkänen. Anomalies Related to the Classical  $Z^0$  Force and Gravitation. In *TGD and Fringe Physics*. Onlinebook. [http://tgdtheory.com/public\\_html/freenergy/freenergy.html#Zanom](http://tgdtheory.com/public_html/freenergy/freenergy.html#Zanom), 2006.
- [K8] M. Pitkänen. Appendix A: Quantum Groups and Related Structures. In *Towards M-Matrix*. Onlinebook. [http://tgdtheory.com/public\\_html/tgdquant/tgdquant.html#bialgebra](http://tgdtheory.com/public_html/tgdquant/tgdquant.html#bialgebra), 2006.
- [K9] M. Pitkänen. Basic Extremals of Kähler Action. In *Physics in Many-Sheeted Space-Time*. Onlinebook. [http://tgdtheory.com/public\\_html/tgdclass/tgdclass.html#class](http://tgdtheory.com/public_html/tgdclass/tgdclass.html#class), 2006.
- [K10] M. Pitkänen. *Bio-Systems as Conscious Holograms*. Onlinebook. [http://tgdtheory.com/public\\_html/hologram/hologram.html](http://tgdtheory.com/public_html/hologram/hologram.html), 2006.
- [K11] M. Pitkänen. Bio-Systems as Conscious Holograms. In *Bio-Systems as Conscious Holograms*. Onlinebook. [http://tgdtheory.com/public\\_html/hologram/hologram.html#hologram](http://tgdtheory.com/public_html/hologram/hologram.html#hologram), 2006.
- [K12] M. Pitkänen. *Bio-Systems as Self-Organizing Quantum Systems*. Onlinebook. [http://tgdtheory.com/public\\_html/bioselforg/bioselforg.html](http://tgdtheory.com/public_html/bioselforg/bioselforg.html), 2006.
- [K13] M. Pitkänen. Bio-Systems as Super-Conductors: part I. In *Quantum Hardware of Living Matter*. Onlinebook. [http://tgdtheory.com/public\\_html/bioware/bioware.html#superc1](http://tgdtheory.com/public_html/bioware/bioware.html#superc1), 2006.
- [K14] M. Pitkänen. Bio-Systems as Super-Conductors: part II. In *Quantum Hardware of Living Matter*. Onlinebook. [http://tgdtheory.com/public\\_html/bioware/bioware.html#superc2](http://tgdtheory.com/public_html/bioware/bioware.html#superc2), 2006.
- [K15] M. Pitkänen. Configuration Space Spinor Structure. In *Quantum Physics as Infinite-Dimensional Geometry*. Onlinebook. [http://tgdtheory.com/public\\_html/tgdgeom/tgdgeom.html#cspin](http://tgdtheory.com/public_html/tgdgeom/tgdgeom.html#cspin), 2006.

- [K16] M. Pitkänen. Construction of elementary particle vacuum functionals. In *p-Adic Length Scale Hypothesis and Dark Matter Hierarchy*. Onlinebook. [http://tgdtheory.com/public\\_html/paddark/paddark.html#elvafu](http://tgdtheory.com/public_html/paddark/paddark.html#elvafu), 2006.
- [K17] M. Pitkänen. Construction of Quantum Theory: M-matrix. In *Towards M-Matrix*. Onlinebook. [http://tgdtheory.com/public\\_html/tgdquant/tgdquant.html#towards](http://tgdtheory.com/public_html/tgdquant/tgdquant.html#towards), 2006.
- [K18] M. Pitkänen. Cosmic Strings. In *Physics in Many-Sheeted Space-Time*. Onlinebook. [http://tgdtheory.com/public\\_html/tgdclass/tgdclass.html#cstrings](http://tgdtheory.com/public_html/tgdclass/tgdclass.html#cstrings), 2006.
- [K19] M. Pitkänen. Crop Circles and Life at Parallel Space-Time Sheets. In *Magnetospheric Consciousness*. Onlinebook. [http://tgdtheory.com/public\\_html/magnconsc/magnconsc.html#crop1](http://tgdtheory.com/public_html/magnconsc/magnconsc.html#crop1), 2006.
- [K20] M. Pitkänen. Crop Circles and Life at Parallel Space-Time Sheets. In *Magnetospheric Consciousness*. Onlinebook. [http://tgdtheory.com/public\\_html/magnconsc/magnconsc.html#crop2](http://tgdtheory.com/public_html/magnconsc/magnconsc.html#crop2), 2006.
- [K21] M. Pitkänen. Dark Forces and Living Matter. In *p-Adic Length Scale Hypothesis and Dark Matter Hierarchy*. Onlinebook. [http://tgdtheory.com/public\\_html/paddark/paddark.html#darkforces](http://tgdtheory.com/public_html/paddark/paddark.html#darkforces), 2006.
- [K22] M. Pitkänen. Dark Matter Hierarchy and Hierarchy of EEGs. In *TGD and EEG*. Onlinebook. [http://tgdtheory.com/public\\_html/tgdeeg/tgdeeg.html#eegdark](http://tgdtheory.com/public_html/tgdeeg/tgdeeg.html#eegdark), 2006.
- [K23] M. Pitkänen. Dark Nuclear Physics and Condensed Matter. In *p-Adic Length Scale Hypothesis and Dark Matter Hierarchy*. Onlinebook. [http://tgdtheory.com/public\\_html/paddark/paddark.html#exonuclear](http://tgdtheory.com/public_html/paddark/paddark.html#exonuclear), 2006.
- [K24] M. Pitkänen. DNA as Topological Quantum Computer. In *Genes and Memes*. Onlinebook. [http://tgdtheory.com/public\\_html/genememe/genememe.html#dnatqc](http://tgdtheory.com/public_html/genememe/genememe.html#dnatqc), 2006.
- [K25] M. Pitkänen. Does TGD Predict the Spectrum of Planck Constants? In *Towards M-Matrix*. Onlinebook. [http://tgdtheory.com/public\\_html/tgdquant/tgdquant.html#Planck](http://tgdtheory.com/public_html/tgdquant/tgdquant.html#Planck), 2006.
- [K26] M. Pitkänen. Evolution in Many-Sheeted Space-Time. In *Genes and Memes*. Onlinebook. [http://tgdtheory.com/public\\_html/genememe/genememe.html#prebio](http://tgdtheory.com/public_html/genememe/genememe.html#prebio), 2006.
- [K27] M. Pitkänen. General Ideas about Many-Sheeted Space-Time: Part I. In *Physics in Many-Sheeted Space-Time*. Onlinebook. [http://tgdtheory.com/public\\_html/tgdclass/tgdclass.html#topcond](http://tgdtheory.com/public_html/tgdclass/tgdclass.html#topcond), 2006.
- [K28] M. Pitkänen. General Theory of Qualia. In *Bio-Systems as Conscious Holograms*. Onlinebook. [http://tgdtheory.com/public\\_html/hologram/hologram.html#qualia](http://tgdtheory.com/public_html/hologram/hologram.html#qualia), 2006.
- [K29] M. Pitkänen. *Genes and Memes*. Onlinebook. [http://tgdtheory.com/public\\_html/genememe/genememe.html](http://tgdtheory.com/public_html/genememe/genememe.html), 2006.
- [K30] M. Pitkänen. Genes and Memes. In *Genes and Memes*. Onlinebook. [http://tgdtheory.com/public\\_html/genememe/genememe.html#genememec](http://tgdtheory.com/public_html/genememe/genememe.html#genememec), 2006.
- [K31] M. Pitkänen. Homeopathy in Many-Sheeted Space-Time. In *Bio-Systems as Conscious Holograms*. Onlinebook. [http://tgdtheory.com/public\\_html/hologram/hologram.html#homeoc](http://tgdtheory.com/public_html/hologram/hologram.html#homeoc), 2006.
- [K32] M. Pitkänen. Macro-Temporal Quantum Coherence and Spin Glass Degeneracy. In *Bio-Systems as Conscious Holograms*. Onlinebook. [http://tgdtheory.com/public\\_html/hologram/hologram.html#macro](http://tgdtheory.com/public_html/hologram/hologram.html#macro), 2006.
- [K33] M. Pitkänen. Macroscopic Quantum Coherence and Quantum Metabolism as Different Sides of the Same Coin. In *Bio-Systems as Conscious Holograms*. Onlinebook. [http://tgdtheory.com/public\\_html/hologram/hologram.html#metab](http://tgdtheory.com/public_html/hologram/hologram.html#metab), 2006.

- [K34] M. Pitkänen. Macroscopic Quantum Phenomena and  $CP_2$  Geometry. In *Physics in Many-Sheeted Space-Time*. Onlinebook. [http://tgdtheory.com/public\\_html/tgdclass/tgdclass.html#super](http://tgdtheory.com/public_html/tgdclass/tgdclass.html#super), 2006.
- [K35] M. Pitkänen. Magnetic Sensory Canvas Hypothesis. In *TGD and EEG*. Onlinebook. [http://tgdtheory.com/public\\_html//tgdeeg/tgdeeg/tgdeeg.html#mec](http://tgdtheory.com/public_html//tgdeeg/tgdeeg/tgdeeg.html#mec), 2006.
- [K36] M. Pitkänen. *Magnetospheric Consciousness*. Onlinebook. [http://tgdtheory.com/public\\_html/magnconsc/magnconsc.html](http://tgdtheory.com/public_html/magnconsc/magnconsc.html), 2006.
- [K37] M. Pitkänen. Magnetospheric Sensory Representations. In *Magnetospheric Consciousness*. Onlinebook. [http://tgdtheory.com/public\\_html/magnconsc/magnconsc.html#srepres](http://tgdtheory.com/public_html/magnconsc/magnconsc.html#srepres), 2006.
- [K38] M. Pitkänen. Many-Sheeted DNA. In *Genes and Memes*. Onlinebook. [http://tgdtheory.com/public\\_html/genememe/genememe.html#genecodec](http://tgdtheory.com/public_html/genememe/genememe.html#genecodec), 2006.
- [K39] M. Pitkänen. Massless states and particle massivation. In *p-Adic Length Scale Hypothesis and Dark Matter Hierarchy*. Onlinebook. [http://tgdtheory.com/public\\_html/paddark/paddark.html#mless](http://tgdtheory.com/public_html/paddark/paddark.html#mless), 2006.
- [K40] M. Pitkänen. *Mathematical Aspects of Consciousness Theory*. Onlinebook. [http://tgdtheory.com/public\\_html/mathconsc/mathconsc.html](http://tgdtheory.com/public_html/mathconsc/mathconsc.html), 2006.
- [K41] M. Pitkänen. Matter, Mind, Quantum. In *TGD Inspired Theory of Consciousness*. Onlinebook. [http://tgdtheory.com/public\\_html/tgdconsc/tgdconsc.html#conscic](http://tgdtheory.com/public_html/tgdconsc/tgdconsc.html#conscic), 2006.
- [K42] M. Pitkänen. Negentropy Maximization Principle. In *TGD Inspired Theory of Consciousness*. Onlinebook. [http://tgdtheory.com/public\\_html/tgdconsc/tgdconsc.html#nmpc](http://tgdtheory.com/public_html/tgdconsc/tgdconsc.html#nmpc), 2006.
- [K43] M. Pitkänen. New Particle Physics Predicted by TGD: Part I. In *p-Adic Length Scale Hypothesis and Dark Matter Hierarchy*. Onlinebook. [http://tgdtheory.com/public\\_html/paddark/paddark.html#mass4](http://tgdtheory.com/public_html/paddark/paddark.html#mass4), 2006.
- [K44] M. Pitkänen. Nuclear String Hypothesis. In *p-Adic Length Scale Hypothesis and Dark Matter Hierarchy*. Onlinebook. [http://tgdtheory.com/public\\_html/paddark/paddark.html#nuclstring](http://tgdtheory.com/public_html/paddark/paddark.html#nuclstring), 2006.
- [K45] M. Pitkänen. *p-Adic length Scale Hypothesis and Dark Matter Hierarchy*. Onlinebook. [http://tgdtheory.com/public\\_html/paddark/paddark.html](http://tgdtheory.com/public_html/paddark/paddark.html), 2006.
- [K46] M. Pitkänen. p-Adic Particle Massivation: Hadron Masses. In *p-Adic Length Scale Hypothesis and Dark Matter Hierarchy*. Onlinebook. [http://tgdtheory.com/public\\_html/paddark/paddark.html#mass3](http://tgdtheory.com/public_html/paddark/paddark.html#mass3), 2006.
- [K47] M. Pitkänen. p-Adic Physics as Physics of Cognition and Intention. In *TGD Inspired Theory of Consciousness*. Onlinebook. [http://tgdtheory.com/public\\_html/tgdconsc/tgdconsc.html#cognic](http://tgdtheory.com/public_html/tgdconsc/tgdconsc.html#cognic), 2006.
- [K48] M. Pitkänen. *Physics in Many-Sheeted Space-Time*. Onlinebook. [http://tgdtheory.com/public\\_html/tgdclass/tgdclass.html](http://tgdtheory.com/public_html/tgdclass/tgdclass.html), 2006.
- [K49] M. Pitkänen. Quantum Antenna Hypothesis. In *Quantum Hardware of Living Matter*. Onlinebook. [http://tgdtheory.com/public\\_html/bioware/bioware.html#tubuc](http://tgdtheory.com/public_html/bioware/bioware.html#tubuc), 2006.
- [K50] M. Pitkänen. Quantum Astrophysics. In *Physics in Many-Sheeted Space-Time*. Onlinebook. [http://tgdtheory.com/public\\_html/tgdclass/tgdclass.html#qastro](http://tgdtheory.com/public_html/tgdclass/tgdclass.html#qastro), 2006.
- [K51] M. Pitkänen. Quantum Control and Coordination in Bio-systems: Part I. In *Bio-Systems as Self-Organizing Quantum Systems*. Onlinebook. [http://tgdtheory.com/public\\_html/bioselforg/bioselforg.html#qcococI](http://tgdtheory.com/public_html/bioselforg/bioselforg.html#qcococI), 2006.
- [K52] M. Pitkänen. Quantum Control and Coordination in Bio-Systems: Part II. In *Bio-Systems as Self-Organizing Quantum Systems*. Onlinebook. [http://tgdtheory.com/public\\_html/bioselforg/bioselforg.html#qcococII](http://tgdtheory.com/public_html/bioselforg/bioselforg.html#qcococII), 2006.

- [K53] M. Pitkänen. *Quantum Hardware of Living Matter*. Onlinebook. [http://tgdtheory.com/public\\_html/bioware/bioware.html](http://tgdtheory.com/public_html/bioware/bioware.html), 2006.
- [K54] M. Pitkänen. Quantum Model for Hearing. In *TGD and EEG*. Onlinebook. [http://tgdtheory.com/public\\_html//tgdeeg/tgdeeg/tgdeeg.html#hearing](http://tgdtheory.com/public_html//tgdeeg/tgdeeg/tgdeeg.html#hearing), 2006.
- [K55] M. Pitkänen. Quantum Model for Nerve Pulse. In *TGD and EEG*. Onlinebook. [http://tgdtheory.com/public\\_html//tgdeeg/tgdeeg/tgdeeg.html#pulse](http://tgdtheory.com/public_html//tgdeeg/tgdeeg/tgdeeg.html#pulse), 2006.
- [K56] M. Pitkänen. Quantum Model for Paranormal Phenomena. In *TGD Inspired Theory of Consciousness*. Onlinebook. [http://tgdtheory.com/public\\_html/tgdconsc/tgdconsc.html#parac](http://tgdtheory.com/public_html/tgdconsc/tgdconsc.html#parac), 2006.
- [K57] M. Pitkänen. Quantum Model for Sensory Representations. In *TGD Inspired Theory of Consciousness*. Onlinebook. [http://tgdtheory.com/public\\_html/tgdconsc/tgdconsc.html#expc](http://tgdtheory.com/public_html/tgdconsc/tgdconsc.html#expc), 2006.
- [K58] M. Pitkänen. Quantum Model of EEG. In *TGD and EEG*. Onlinebook. [http://tgdtheory.com/public\\_html/tgdeeg/tgdeeg.html#eegII](http://tgdtheory.com/public_html/tgdeeg/tgdeeg.html#eegII), 2006.
- [K59] M. Pitkänen. Quantum Model of Memory. In *TGD Inspired Theory of Consciousness*. Onlinebook. [http://tgdtheory.com/public\\_html/tgdconsc/tgdconsc.html#memoryc](http://tgdtheory.com/public_html/tgdconsc/tgdconsc.html#memoryc), 2006.
- [K60] M. Pitkänen. *Quantum Physics as Infinite-Dimensional Geometry*. Onlinebook. [http://tgdtheory.com/public\\_html/tgdgeom/tgdgeom.html](http://tgdtheory.com/public_html/tgdgeom/tgdgeom.html), 2006.
- [K61] M. Pitkänen. *Quantum TGD*. Onlinebook. [http://tgdtheory.com/public\\_html/tgdquant/tgdquant.html](http://tgdtheory.com/public_html/tgdquant/tgdquant.html), 2006.
- [K62] M. Pitkänen. Quantum Theory of Self-Organization. In *Bio-Systems as Self-Organizing Quantum Systems*. Onlinebook. [http://tgdtheory.com/public\\_html/bioselforg/bioselforg.html#selforgac](http://tgdtheory.com/public_html/bioselforg/bioselforg.html#selforgac), 2006.
- [K63] M. Pitkänen. Semi-trance, Mental Illness, and Altered States of Consciousness. In *Magnetospheric Consciousness*. Onlinebook. [http://tgdtheory.com/public\\_html/magnconsc/magnconsc.html#semitrancec](http://tgdtheory.com/public_html/magnconsc/magnconsc.html#semitrancec), 2006.
- [K64] M. Pitkänen. Semitrance, Language, and Development of Civilization. In *Magnetospheric Consciousness*. Onlinebook. [http://tgdtheory.com/public\\_html/magnconsc/magnconsc.html#langsoc](http://tgdtheory.com/public_html/magnconsc/magnconsc.html#langsoc), 2006.
- [K65] M. Pitkänen. TGD and Astrophysics. In *Physics in Many-Sheeted Space-Time*. Onlinebook. [http://tgdtheory.com/public\\_html/tgdclass/tgdclass.html#astro](http://tgdtheory.com/public_html/tgdclass/tgdclass.html#astro), 2006.
- [K66] M. Pitkänen. TGD and Cosmology. In *Physics in Many-Sheeted Space-Time*. Onlinebook. [http://tgdtheory.com/public\\_html/tgdclass/tgdclass.html#cosmo](http://tgdtheory.com/public_html/tgdclass/tgdclass.html#cosmo), 2006.
- [K67] M. Pitkänen. *TGD and EEG*. Onlinebook. [http://tgdtheory.com/public\\_html/tgdeeg/tgdeeg.html](http://tgdtheory.com/public_html/tgdeeg/tgdeeg.html), 2006.
- [K68] M. Pitkänen. *TGD and Fringe Physics*. Onlinebook. [http://tgdtheory.com/public\\_html/freenergy/freenergy.html](http://tgdtheory.com/public_html/freenergy/freenergy.html), 2006.
- [K69] M. Pitkänen. TGD and Nuclear Physics. In *p-Adic Length Scale Hypothesis and Dark Matter Hierarchy*. Onlinebook. [http://tgdtheory.com/public\\_html/paddark/paddark.html#padnucl](http://tgdtheory.com/public_html/paddark/paddark.html#padnucl), 2006.
- [K70] M. Pitkänen. *TGD as a Generalized Number Theory*. Onlinebook. [http://tgdtheory.com/public\\_html/tgdnumber/tgdnumber.html](http://tgdtheory.com/public_html/tgdnumber/tgdnumber.html), 2006.
- [K71] M. Pitkänen. TGD as a Generalized Number Theory: p-Adicization Program. In *TGD as a Generalized Number Theory*. Onlinebook. [http://tgdtheory.com/public\\_html/tgdnumber/tgdnumber.html#visiona](http://tgdtheory.com/public_html/tgdnumber/tgdnumber.html#visiona), 2006.



- [K72] M. Pitkänen. TGD as a Generalized Number Theory: Quaternions, Octonions, and their Hyper Counterparts. In *TGD as a Generalized Number Theory*. Onlinebook. [http://tgdtheory.com/public\\_html/tgdnumber/tgdnumber.html#visionb](http://tgdtheory.com/public_html/tgdnumber/tgdnumber.html#visionb), 2006.
- [K73] M. Pitkänen. TGD Based Model for OBEs. In *TGD Inspired Theory of Consciousness*. Onlinebook. [http://tgdtheory.com/public\\_html/tgdconsc/tgdconsc.html#OBE](http://tgdtheory.com/public_html/tgdconsc/tgdconsc.html#OBE), 2006.
- [K74] M. Pitkänen. *TGD Inspired Theory of Consciousness*. Onlinebook. [http://tgdtheory.com/public\\_html/tgdconsc/tgdconsc.html](http://tgdtheory.com/public_html/tgdconsc/tgdconsc.html), 2006.
- [K75] M. Pitkänen. TGD Inspired Theory of Consciousness. In *Topological Geometrodynamics: Overview*. Onlinebook. [http://tgdtheory.com/public\\_html/tgdview/tgdview.html#tgdconsc2010](http://tgdtheory.com/public_html/tgdview/tgdview.html#tgdconsc2010), 2006.
- [K76] M. Pitkänen. The Notion of Free Energy and Many-Sheeted Space-Time Concept. In *TGD and Fringe Physics*. Onlinebook. [http://tgdtheory.com/public\\_html/freenergy/freenergy.html#freenergy](http://tgdtheory.com/public_html/freenergy/freenergy.html#freenergy), 2006.
- [K77] M. Pitkänen. The Relationship Between TGD and GRT. In *Physics in Many-Sheeted Space-Time*. Onlinebook. [http://tgdtheory.com/public\\_html/tgdclass/tgdclass.html#tgdgrt](http://tgdtheory.com/public_html/tgdclass/tgdclass.html#tgdgrt), 2006.
- [K78] M. Pitkänen. Three new physics realizations of the genetic code and the role of dark matter in bio-systems. In *Genes and Memes*. Onlinebook. [http://tgdtheory.com/public\\_html/genememe/genememe.html#dnatqccodes](http://tgdtheory.com/public_html/genememe/genememe.html#dnatqccodes), 2006.
- [K79] M. Pitkänen. Time, Spacetime and Consciousness. In *Bio-Systems as Conscious Holograms*. Onlinebook. [http://tgdtheory.com/public\\_html/hologram/hologram.html#time](http://tgdtheory.com/public_html/hologram/hologram.html#time), 2006.
- [K80] M. Pitkänen. *Topological Geometrodynamics: an Overview*. Onlinebook. [http://tgdtheory.com/public\\_html/tgdview/tgdview.html](http://tgdtheory.com/public_html/tgdview/tgdview.html), 2006.
- [K81] M. Pitkänen. Topological Quantum Computation in TGD Universe. In *Genes and Memes*. Onlinebook. [http://tgdtheory.com/public\\_html/genememe/genememe.html#tqc](http://tgdtheory.com/public_html/genememe/genememe.html#tqc), 2006.
- [K82] M. Pitkänen. Was von Neumann Right After All. In *Towards M-Matrix*. Onlinebook. [http://tgdtheory.com/public\\_html/tgdquant/tgdquant.html#vNeumann](http://tgdtheory.com/public_html/tgdquant/tgdquant.html#vNeumann), 2006.
- [K83] M. Pitkänen. Wormhole Magnetic Fields. In *Quantum Hardware of Living Matter*. Onlinebook. [http://tgdtheory.com/public\\_html/bioware/bioware.html#wormc](http://tgdtheory.com/public_html/bioware/bioware.html#wormc), 2006.

## A-5 Basic properties of $CP_2$ and elementary facts about p-adic numbers

### A-5.1 $CP_2$ as a manifold

$CP_2$ , the complex projective space of two complex dimensions, is obtained by identifying the points of complex 3-space  $C^3$  under the projective equivalence

$$(z^1, z^2, z^3) \equiv \lambda(z^1, z^2, z^3) . \quad (\text{A-5.1})$$

Here  $\lambda$  is any non-zero complex number. Note that  $CP_2$  can be also regarded as the coset space  $SU(3)/U(2)$ . The pair  $z^i/z^j$  for fixed  $j$  and  $z^i \neq 0$  defines a complex coordinate chart for  $CP_2$ . As  $j$  runs from 1 to 3 one obtains an atlas of three oordinate charts covering  $CP_2$ , the charts being holomorphically related to each other (e.g.  $CP_2$  is a complex manifold). The points  $z^3 \neq 0$  form a subset of  $CP_2$  homoeomorphic to  $R^4$  and the points with  $z^3 = 0$  a set homeomorphic to  $S^2$ . Therefore  $CP_2$  is obtained by "adding the 2-sphere at infinity to  $R^4$ ".

Besides the standard complex coordinates  $\xi^i = z^i/z^3$ ,  $i = 1, 2$  the coordinates of Eguchi and Freund [A13] will be used and their relation to the complex coordinates is given by

$$\begin{aligned}\xi^1 &= z + it \ , \\ \xi^2 &= x + iy \ .\end{aligned}\tag{A-5.2}$$

These are related to the "spherical coordinates" via the equations

$$\begin{aligned}\xi^1 &= r \exp(i \frac{(\Psi + \Phi)}{2}) \cos(\frac{\Theta}{2}) \ , \\ \xi^2 &= r \exp(i \frac{(\Psi - \Phi)}{2}) \sin(\frac{\Theta}{2}) \ .\end{aligned}\tag{A-5.3}$$

The ranges of the variables  $r, \Theta, \Phi, \Psi$  are  $[0, \infty], [0, \pi], [0, 4\pi], [0, 2\pi]$  respectively.

Considered as a real four-manifold  $CP_2$  is compact and simply connected, with Euler number Euler number 3, Pontryagin number 3 and second  $b = 1$ .

### A-5.2 Metric and Kähler structure of $CP_2$

In order to obtain a natural metric for  $CP_2$ , observe that  $CP_2$  can be thought of as a set of the orbits of the isometries  $z^i \rightarrow \exp(i\alpha)z^i$  on the sphere  $S^5$ :  $\sum z^i \bar{z}^i = R^2$ . The metric of  $CP_2$  is obtained by projecting the metric of  $S^5$  orthogonally to the orbits of the isometries. Therefore the distance between the points of  $CP_2$  is that between the representative orbits on  $S^5$ .

The line element has the following form in the complex coordinates

$$ds^2 = g_{a\bar{b}} d\xi^a d\bar{\xi}^b \ ,\tag{A-5.4}$$

where the Hermitian, in fact Kähler metric  $g_{a\bar{b}}$  is defined by

$$g_{a\bar{b}} = R^2 \partial_a \partial_{\bar{b}} K \ ,\tag{A-5.5}$$

where the function  $K$ , Kähler function, is defined as

$$\begin{aligned}K &= \log(F) \ , \\ F &= 1 + r^2 \ .\end{aligned}\tag{A-5.6}$$

The Kähler function for  $S^2$  has the same form. It gives the  $S^2$  metric  $dzd\bar{z}/(1+r^2)^2$  related to its standard form in spherical coordinates by the coordinate transformation  $(r, \phi) = (\tan(\theta/2), \phi)$ .

The representation of the  $CP_2$  metric is deducible from  $S^5$  metric is obtained by putting the angle coordinate of a geodesic sphere constant in it and is given

$$\frac{ds^2}{R^2} = \frac{(dr^2 + r^2 \sigma_3^2)}{F^2} + \frac{r^2(\sigma_1^2 + \sigma_2^2)}{F} \ ,\tag{A-5.7}$$

where the quantities  $\sigma_i$  are defined as

$$\begin{aligned}r^2 \sigma_1 &= \text{Im}(\xi^1 d\xi^2 - \xi^2 d\xi^1) \ , \\ r^2 \sigma_2 &= -\text{Re}(\xi^1 d\xi^2 - \xi^2 d\xi^1) \ , \\ r^2 \sigma_3 &= -\text{Im}(\xi^1 d\bar{\xi}^1 + \xi^2 d\bar{\xi}^2) \ .\end{aligned}\tag{A-5.8}$$

$R$  denotes the radius of the geodesic circle of  $CP_2$ . The vierbein forms, which satisfy the defining relation

$$s_{kl} = R^2 \sum_A e_k^A e_l^A \ ,\tag{A-5.9}$$

are given by

$$\begin{aligned} e^0 &= \frac{dr}{F}, & e^1 &= \frac{r\sigma_1}{\sqrt{F}}, \\ e^2 &= \frac{r\sigma_2}{\sqrt{F}}, & e^3 &= \frac{r\sigma_3}{F}. \end{aligned} \quad (\text{A-5.10})$$

The explicit representations of vierbein vectors are given by

$$\begin{aligned} e^0 &= \frac{dr}{F}, & e^1 &= \frac{r(\sin\Theta\cos\Psi d\Phi + \sin\Psi d\Theta)}{2\sqrt{F}}, \\ e^2 &= \frac{r(\sin\Theta\sin\Psi d\Phi - \cos\Psi d\Theta)}{2\sqrt{F}}, & e^3 &= \frac{r(d\Psi + \cos\Theta d\Phi)}{2F}. \end{aligned} \quad (\text{A-5.11})$$

The explicit representation of the line element is given by the expression

$$ds^2/R^2 = \frac{dr^2}{F^2} + \frac{r^2}{4F^2}(d\Psi + \cos\Theta d\Phi)^2 + \frac{r^2}{4F}(d\Theta^2 + \sin^2\Theta d\Phi^2). \quad (\text{A-5.12})$$

The vierbein connection satisfying the defining relation

$$de^A = -V_B^A \wedge e^B, \quad (\text{A-5.13})$$

is given by

$$\begin{aligned} V_{01} &= -\frac{e^1}{r}, & V_{23} &= \frac{e^1}{r}, \\ V_{02} &= -\frac{e^2}{r}, & V_{31} &= \frac{e^2}{r}, \\ V_{03} &= (r - \frac{1}{r})e^3, & V_{12} &= (2r + \frac{1}{r})e^3. \end{aligned} \quad (\text{A-5.14})$$

The representation of the covariantly constant curvature tensor is given by

$$\begin{aligned} R_{01} &= e^0 \wedge e^1 - e^2 \wedge e^3, & R_{23} &= e^0 \wedge e^1 - e^2 \wedge e^3, \\ R_{02} &= e^0 \wedge e^2 - e^3 \wedge e^1, & R_{31} &= -e^0 \wedge e^2 + e^3 \wedge e^1, \\ R_{03} &= 4e^0 \wedge e^3 + 2e^1 \wedge e^2, & R_{12} &= 2e^0 \wedge e^3 + 4e^1 \wedge e^2. \end{aligned} \quad (\text{A-5.15})$$

Metric defines a real, covariantly constant, and therefore closed 2-form  $J$

$$J = -ig_{a\bar{b}}d\xi^a d\bar{\xi}^b, \quad (\text{A-5.16})$$

the so called Kähler form. Kähler form  $J$  defines in  $CP_2$  a symplectic structure because it satisfies the condition

$$J^k_r J^{rl} = -s^{kl}. \quad (\text{A-5.17})$$

The form  $J$  is integer valued and by its covariant constancy satisfies free Maxwell equations. Hence it can be regarded as a curvature form of a  $U(1)$  gauge potential  $B$  carrying a magnetic charge of unit  $1/2g$  ( $g$  denotes the gauge coupling). Locally one has therefore

$$J = dB, \quad (\text{A-5.18})$$

where  $B$  is the so called Kähler potential, which is not defined globally since  $J$  describes homological magnetic monopole.

It should be noticed that the magnetic flux of  $J$  through a 2-surface in  $CP_2$  is proportional to its homology equivalence class, which is integer valued. The explicit representations of  $J$  and  $B$  are given by

$$\begin{aligned} B &= 2re^3 , \\ J &= 2(e^0 \wedge e^3 + e^1 \wedge e^2) = \frac{r}{F^2} dr \wedge (d\Psi + \cos\Theta d\Phi) + \frac{r^2}{2F} \sin\Theta d\Theta d\Phi . \end{aligned} \quad (\text{A-5.19})$$

The vierbein curvature form and Kähler form are covariantly constant and have in the complex coordinates only components of type (1,1).

Useful coordinates for  $CP_2$  are the so called canonical coordinates in which Kähler potential and Kähler form have very simple expressions

$$\begin{aligned} B &= \sum_{k=1,2} P_k dQ_k , \\ J &= \sum_{k=1,2} dP_k \wedge dQ_k . \end{aligned} \quad (\text{A-5.20})$$

The relationship of the canonical coordinates to the "spherical" coordinates is given by the equations

$$\begin{aligned} P_1 &= -\frac{1}{1+r^2} , \\ P_2 &= \frac{r^2 \cos\Theta}{2(1+r^2)} , \\ Q_1 &= \Psi , \\ Q_2 &= \Phi . \end{aligned} \quad (\text{A-5.21})$$

### A-5.3 Spinors in $CP_2$

$CP_2$  doesn't allow spinor structure in the conventional sense [A10] . However, the coupling of the spinors to a half odd multiple of the Kähler potential leads to a respectable spinor structure. Because the delicacies associated with the spinor structure of  $CP_2$  play a fundamental role in TGD, the arguments of Hawking are repeated here.

To see how the space can fail to have an ordinary spinor structure consider the parallel transport of the vierbein in a simply connected space  $M$ . The parallel propagation around a closed curve with a base point  $x$  leads to a rotated vierbein at  $x$ :  $e^A = R_B^A e^B$  and one can associate to each closed path an element of  $SO(4)$ .

Consider now a one-parameter family of closed curves  $\gamma(v) : v \in (0,1)$  with the same base point  $x$  and  $\gamma(0)$  and  $\gamma(1)$  trivial paths. Clearly these paths define a sphere  $S^2$  in  $M$  and the element  $R_B^A(v)$  defines a closed path in  $SO(4)$ . When the sphere  $S^2$  is contractible to a point e.g., homologically trivial, the path in  $SO(4)$  is also contractible to a point and therefore represents a trivial element of the homotopy group  $\Pi_1(SO(4)) = Z_2$ .

For a homologically nontrivial 2-surface  $S^2$  the associated path in  $SO(4)$  can be homotopically nontrivial and therefore corresponds to a nonclosed path in the covering group  $\text{Spin}(4)$  (leading from the matrix 1 to -1 in the matrix representation). Assume this is the case.

Assume now that the space allows spinor structure. Then one can parallel propagate also spinors and by the above construction associate a closed path of  $\text{Spin}(4)$  to the surface  $S^2$ . Now, however this path corresponds to a lift of the corresponding  $SO(4)$  path and cannot be closed. Thus one ends up with a contradiction.

From the preceding argument it is clear that one could compensate the non-allowed  $-1$ - factor associated with the parallel transport of the spinor around the sphere  $S^2$  by coupling it to a gauge potential in such a way that in the parallel transport the gauge potential introduces a compensating  $-1$ -factor. For a  $U(1)$  gauge potential this factor is given by the exponential  $\exp(i2\Phi)$  , where  $\Phi$

is the magnetic flux through the surface. This factor has the value  $-1$  provided the  $U(1)$  potential carries half odd multiple of Dirac charge  $1/2g$ . In case of  $CP_2$  the required gauge potential is half odd multiple of the Kähler potential  $B$  defined previously. In the case of  $M^4 \times CP_2$  one can in addition couple the spinor components with different chiralities independently to an odd multiple of  $B/2$ .

### A-5.4 Geodesic sub-manifolds of $CP_2$

Geodesic sub-manifolds are defined as sub-manifolds having common geodesic lines with the imbedding space. As a consequence the second fundamental form of the geodesic manifold vanishes, which means that the tangent vectors  $h_\alpha^k$  (understood as vectors of  $H$ ) are covariantly constant quantities with respect to the covariant derivative taking into account that the tangent vectors are vectors both with respect to  $H$  and  $X^4$ .

In [A6] a general characterization of the geodesic sub-manifolds for an arbitrary symmetric space  $G/H$  is given. Geodesic sub-manifolds are in 1-1-correspondence with the so called Lie triple systems of the Lie-algebra  $g$  of the group  $G$ . The Lie triple system  $t$  is defined as a subspace of  $g$  characterized by the closedness property with respect to double commutation

$$[X, [Y, Z]] \in t \text{ for } X, Y, Z \in t . \tag{A-5.22}$$

$SU(3)$  allows, besides geodesic lines, two nonequivalent (not isometry related) geodesic spheres. This is understood by observing that  $SU(3)$  allows two nonequivalent  $SU(2)$  algebras corresponding to subgroups  $SO(3)$  (orthogonal  $3 \times 3$  matrices) and the usual isospin group  $SU(2)$ . By taking any subset of two generators from these algebras, one obtains a Lie triple system and by exponentiating this system, one obtains a 2-dimensional geodesic sub-manifold of  $CP_2$ .

Standard representatives for the geodesic spheres of  $CP_2$  are given by the equations

$$S_I^2 : \xi^1 = \bar{\xi}^2 \text{ or equivalently } (\Theta = \pi/2, \Psi = 0) ,$$

$$S_{II}^2 : \xi^1 = \xi^2 \text{ or equivalently } (\Theta = \pi/2, \Phi = 0) .$$

The non-equivalence of these sub-manifolds is clear from the fact that isometries act as holomorphic transformations in  $CP_2$ . The vanishing of the second fundamental form is also easy to verify. The first geodesic manifold is homologically trivial: in fact, the induced Kähler form vanishes identically for  $S_I^2$ .  $S_{II}^2$  is homologically nontrivial and the flux of the Kähler form gives its homology equivalence class.

## A-6 $CP_2$ geometry and standard model symmetries

### A-6.1 Identification of the electro-weak couplings

The delicacies of the spinor structure of  $CP_2$  make it a unique candidate for space  $S$ . First, the coupling of the spinors to the  $U(1)$  gauge potential defined by the Kähler structure provides the missing  $U(1)$  factor in the gauge group. Secondly, it is possible to couple different  $H$ -chiralities independently to a half odd multiple of the Kähler potential. Thus the hopes of obtaining a correct spectrum for the electromagnetic charge are considerable. In the following it will be demonstrated that the couplings of the induced spinor connection are indeed those of the GWS model [B2] and in particular that the right handed neutrinos decouple completely from the electro-weak interactions.

To begin with, recall that the space  $H$  allows to define three different chiralities for spinors. Spinors with fixed  $H$ -chirality  $e = \pm 1$ ,  $CP_2$ -chirality  $l, r$  and  $M^4$ -chirality  $L, R$  are defined by the condition

$$\begin{aligned} \Gamma\Psi &= e\Psi , \\ e &= \pm 1 , \end{aligned} \tag{A-6.1}$$

where  $\Gamma$  denotes the matrix  $\Gamma_9 = \gamma_5 \times \gamma_5$ ,  $1 \times \gamma_5$  and  $\gamma_5 \times 1$  respectively. Clearly, for a fixed  $H$ -chirality  $CP_2$ - and  $M^4$ -chiralities are correlated.

The spinors with  $H$ -chirality  $e = \pm 1$  can be identified as quark and lepton like spinors respectively. The separate conservation of baryon and lepton numbers can be understood as a consequence of generalized chiral invariance if this identification is accepted. For the spinors with a definite  $H$ -chirality one can identify the vielbein group of  $CP_2$  as the electro-weak group:  $SO(4) = SU(2)_L \times SU(2)_R$ .

The covariant derivatives are defined by the spinorial connection

$$A = V + \frac{B}{2}(n_+1_+ + n_-1_-) . \quad (\text{A-6.2})$$

Here  $V$  and  $B$  denote the projections of the vielbein and Kähler gauge potentials respectively and  $1_{+(-)}$  projects to the spinor  $H$ -chirality  $+(-)$ . The integers  $n_{\pm}$  are odd from the requirement of a respectable spinor structure.

The explicit representation of the vielbein connection  $V$  and of  $B$  are given by the equations

$$\begin{aligned} V_{01} &= -\frac{e^1}{r_2} , & V_{23} &= \frac{e^1}{r_2} , \\ V_{02} &= -\frac{e^2}{r} , & V_{31} &= \frac{e^2}{r} , \\ V_{03} &= (r - \frac{1}{r})e^3 , & V_{12} &= (2r + \frac{1}{r})e^3 , \end{aligned} \quad (\text{A-6.3})$$

and

$$B = 2re^3 , \quad (\text{A-6.4})$$

respectively. The explicit representation of the vielbein is not needed here.

Let us first show that the charged part of the spinor connection couples purely left handedly. Identifying  $\Sigma_3^0$  and  $\Sigma_2^1$  as the diagonal (neutral) Lie-algebra generators of  $SO(4)$ , one finds that the charged part of the spinor connection is given by

$$A_{ch} = 2V_{23}I_L^1 + 2V_{13}I_L^2 , \quad (\text{A-6.5})$$

where one have defined

$$\begin{aligned} I_L^1 &= \frac{(\Sigma_{01} - \Sigma_{23})}{2} , \\ I_L^2 &= \frac{(\Sigma_{02} - \Sigma_{13})}{2} . \end{aligned} \quad (\text{A-6.6})$$

$A_{ch}$  is clearly left handed so that one can perform the identification

$$W^{\pm} = \frac{2(e^1 \pm ie^2)}{r} , \quad (\text{A-6.7})$$

where  $W^{\pm}$  denotes the charged intermediate vector boson.

Consider next the identification of the neutral gauge bosons  $\gamma$  and  $Z^0$  as appropriate linear combinations of the two functionally independent quantities

$$\begin{aligned} X &= re^3 , \\ Y &= \frac{e^3}{r} , \end{aligned} \quad (\text{A-6.8})$$

appearing in the neutral part of the spinor connection. We show first that the mere requirement that photon couples vectorially implies the basic coupling structure of the GWS model leaving only the value of Weinberg angle undetermined.

To begin with let us define

$$\begin{aligned}\bar{\gamma} &= aX + bY , \\ \bar{Z}^0 &= cX + dY ,\end{aligned}\tag{A-6.9}$$

where the normalization condition

$$ad - bc = 1 ,$$

is satisfied. The physical fields  $\gamma$  and  $Z^0$  are related to  $\bar{\gamma}$  and  $\bar{Z}^0$  by simple normalization factors.

Expressing the neutral part of the spinor connection in term of these fields one obtains

$$\begin{aligned}A_{nc} &= [(c + d)2\Sigma_{03} + (2d - c)2\Sigma_{12} + d(n_+1_+ + n_-1_-)]\bar{\gamma} \\ &+ [(a - b)2\Sigma_{03} + (a - 2b)2\Sigma_{12} - b(n_+1_+ + n_-1_-)]\bar{Z}^0 .\end{aligned}\tag{A-6.10}$$

Identifying  $\Sigma_{12}$  and  $\Sigma_{03} = 1 \times \gamma_5 \Sigma_{12}$  as vectorial and axial Lie-algebra generators, respectively, the requirement that  $\gamma$  couples vectorially leads to the condition

$$c = -d .\tag{A-6.11}$$

Using this result plus previous equations, one obtains for the neutral part of the connection the expression

$$A_{nc} = \gamma Q_{em} + Z^0 (I_L^3 - \sin^2 \theta_W Q_{em}) .\tag{A-6.12}$$

Here the electromagnetic charge  $Q_{em}$  and the weak isospin are defined by

$$\begin{aligned}Q_{em} &= \Sigma^{12} + \frac{(n_+1_+ + n_-1_-)}{6} , \\ I_L^3 &= \frac{(\Sigma^{12} - \Sigma^{03})}{2} .\end{aligned}\tag{A-6.13}$$

The fields  $\gamma$  and  $Z^0$  are defined via the relations

$$\begin{aligned}\gamma &= 6d\bar{\gamma} = \frac{6}{(a+b)}(aX + bY) , \\ Z^0 &= 4(a+b)\bar{Z}^0 = 4(X - Y) .\end{aligned}\tag{A-6.14}$$

The value of the Weinberg angle is given by

$$\sin^2 \theta_W = \frac{3b}{2(a+b)} ,\tag{A-6.15}$$

and is not fixed completely. Observe that right handed neutrinos decouple completely from the electro-weak interactions.

The determination of the value of Weinberg angle is a dynamical problem. The angle is completely fixed once the YM action is fixed by requiring that action contains no cross term of type  $\gamma Z^0$ . Pure symmetry non-broken electro-weak YM action leads to a definite value for the Weinberg angle. One can however add a symmetry breaking term proportional to Kähler action and this changes the value of the Weinberg angle.

To evaluate the value of the Weinberg angle one can express the neutral part  $F_{nc}$  of the induced gauge field as

$$F_{nc} = 2R_{03}\Sigma^{03} + 2R_{12}\Sigma^{12} + J(n_+1_+ + n_-1_-) ,\tag{A-6.16}$$

where one has

$$\begin{aligned} R_{03} &= 2(2e^0 \wedge e^3 + e^1 \wedge e^2) , \\ R_{12} &= 2(e^0 \wedge e^3 + 2e^1 \wedge e^2) , \\ J &= 2(e^0 \wedge e^3 + e^1 \wedge e^2) , \end{aligned} \quad (\text{A-6.17})$$

in terms of the fields  $\gamma$  and  $Z^0$  (photon and  $Z$ - boson)

$$F_{nc} = \gamma Q_{em} + Z^0(I_L^3 - \sin^2\theta_W Q_{em}) . \quad (\text{A-6.18})$$

Evaluating the expressions above one obtains for  $\gamma$  and  $Z^0$  the expressions

$$\begin{aligned} \gamma &= 3J - \sin^2\theta_W R_{03} , \\ Z^0 &= 2R_{03} . \end{aligned} \quad (\text{A-6.19})$$

For the Kähler field one obtains

$$J = \frac{1}{3}(\gamma + \sin^2\theta_W Z^0) . \quad (\text{A-6.20})$$

Expressing the neutral part of the symmetry broken YM action

$$\begin{aligned} L_{ew} &= L_{sym} + f J^{\alpha\beta} J_{\alpha\beta} , \\ L_{sym} &= \frac{1}{4g^2} \text{Tr}(F^{\alpha\beta} F_{\alpha\beta}) , \end{aligned} \quad (\text{A-6.21})$$

where the trace is taken in spinor representation, in terms of  $\gamma$  and  $Z^0$  one obtains for the coefficient  $X$  of the  $\gamma Z^0$  cross term (this coefficient must vanish) the expression

$$\begin{aligned} X &= -\frac{K}{2g^2} + \frac{fp}{18} , \\ K &= \text{Tr} [Q_{em}(I_L^3 - \sin^2\theta_W Q_{em})] , \end{aligned} \quad (\text{A-6.22})$$

In the general case the value of the coefficient  $K$  is given by

$$K = \sum_i \left[ -\frac{(18 + 2n_i^2)\sin^2\theta_W}{9} \right] , \quad (\text{A-6.23})$$

where the sum is over the spinor chiralities, which appear as elementary fermions and  $n_i$  is the integer describing the coupling of the spinor field to the Kähler potential. The cross term vanishes provided the value of the Weinberg angle is given by

$$\sin^2\theta_W = \frac{9 \sum_i 1}{(fg^2 + 2 \sum_i (18 + n_i^2))} . \quad (\text{A-6.24})$$

In the scenario where both leptons and quarks are elementary fermions the value of the Weinberg angle is given by

$$\sin^2\theta_W = \frac{9}{(\frac{fg^2}{2} + 28)} . \quad (\text{A-6.25})$$

The bare value of the Weinberg angle is  $9/28$  in this scenario, which is quite close to the typical value  $9/24$  of GUTs [B5] .



### A-6.2 Discrete symmetries

The treatment of discrete symmetries C, P, and T is based on the following requirements:

- a) Symmetries must be realized as purely geometric transformations.
- b) Transformation properties of the field variables should be essentially the same as in the conventional quantum field theories [B1] .

The action of the reflection  $P$  on spinors of is given by

$$\Psi \rightarrow P\Psi = \gamma^0 \otimes \gamma^0 \Psi . \tag{A-6.26}$$

in the representation of the gamma matrices for which  $\gamma^0$  is diagonal. It should be noticed that  $W$  and  $Z^0$  bosons break parity symmetry as they should since their charge matrices do not commute with the matrix of  $P$ .

The guess that a complex conjugation in  $CP_2$  is associated with T transformation of the physicist turns out to be correct. One can verify by a direct calculation that pure Dirac action is invariant under T realized according to

$$\begin{aligned} m^k &\rightarrow T(M^k) , \\ \xi^k &\rightarrow \bar{\xi}^k , \\ \Psi &\rightarrow \gamma^1 \gamma^3 \otimes 1 \Psi . \end{aligned} \tag{A-6.27}$$

The operation bearing closest resemblance to the ordinary charge conjugation corresponds geometrically to complex conjugation in  $CP_2$ :

$$\begin{aligned} \xi^k &\rightarrow \bar{\xi}^k , \\ \Psi &\rightarrow \Psi^\dagger \gamma^2 \gamma^0 \otimes 1 . \end{aligned} \tag{A-6.28}$$

As one might have expected symmetries CP and T are exact symmetries of the pure Dirac action.

## A-7 Basic facts about induced gauge fields

Since the classical gauge fields are closely related in TGD framework, it is not possible to have space-time sheets carrying only single kind of gauge field. For instance, em fields are accompanied by  $Z^0$  fields for extremals of Kähler action. Weak forces is however absent unless the space-time sheets contains topologically condensed exotic weakly charged particles responding to this force. Same applies to classical color forces. The fact that these long range fields are present forces to assume that there exists a hierarchy of scaled up variants of standard model physics identifiable in terms of dark matter.

Classical em fields are always accompanied by  $Z^0$  field and some components of color gauge field. For extremals having homologically non-trivial sphere as a  $CP_2$  projection em and  $Z^0$  fields are the only non-vanishing electroweak gauge fields. For homologically trivial sphere only  $W$  fields are non-vanishing. Color rotations does not affect the situation.

For vacuum extremals all electro-weak gauge fields are in general non-vanishing although the net gauge field has  $U(1)$  holonomy by 2-dimensionality of the  $CP_2$  projection. Color gauge field has  $U(1)$  holonomy for all space-time surfaces and quantum classical correspondence suggest a weak form of color confinement meaning that physical states correspond to color neutral members of color multiplets.

### A-7.1 Induced gauge fields for space-times for which $CP_2$ projection is a geodesic sphere

If one requires that space-time surface is an extremal of Kähler action and has a 2-dimensional  $CP_2$  projection, only vacuum extremals and space-time surfaces for which  $CP_2$  projection is a geodesic sphere, are allowed. Homologically non-trivial geodesic sphere correspond to vanishing  $W$  fields and homologically non-trivial sphere to non-vanishing  $W$  fields but vanishing  $\gamma$  and  $Z^0$ . This can be verified by explicit examples.

$r = \infty$  surface gives rise to a homologically non-trivial geodesic sphere for which  $e_0$  and  $e_3$  vanish imply the vanishing of  $W$  field. For space-time sheets for which  $CP_2$  projection is  $r = \infty$  homologically non-trivial geodesic sphere of  $CP_2$  one has

$$\gamma = \left(\frac{3}{4} - \frac{\sin^2(\theta_W)}{2}\right)Z^0 \simeq \frac{5Z^0}{8} .$$

The induced  $W$  fields vanish in this case and they vanish also for all geodesic sphere obtained by  $SU(3)$  rotation.

$Im(\xi^1) = Im(\xi^2) = 0$  corresponds to homologically trivial geodesic sphere. A more general representative is obtained by using for the phase angles of standard complex  $CP_2$  coordinates constant values. In this case  $e^1$  and  $e^3$  vanish so that the induced em,  $Z^0$ , and Kähler fields vanish but induced  $W$  fields are non-vanishing. This holds also for surfaces obtained by color rotation. Hence one can say that for non-vacuum extremals with 2-D  $CP_2$  projection color rotations and weak symmetries commute.

### A-7.2 Space-time surfaces with vanishing em, $Z^0$ , or Kähler fields

In the following the induced gauge fields are studied for general space-time surface without assuming the extremal property. In fact, extremal property reduces the study to the study of vacuum extremals and surfaces having geodesic sphere as a  $CP_2$  projection and in this sense the following arguments are somewhat obsolete in their generality.

#### Space-times with vanishing em, $Z^0$ , or Kähler fields

The following considerations apply to a more general situation in which the homologically trivial geodesic sphere and extremal property are not assumed. It must be emphasized that this case is possible in TGD framework only for a vanishing Kähler field.

Using spherical coordinates  $(r, \Theta, \Psi, \Phi)$  for  $CP_2$ , the expression of Kähler form reads as

$$\begin{aligned} J &= \frac{r}{F^2} dr \wedge (d\Psi + \cos(\Theta)d\Phi) + \frac{r^2}{2F} \sin(\Theta)d\Theta \wedge d\Phi , \\ F &= 1 + r^2 . \end{aligned} \tag{A-7.1}$$

The general expression of electromagnetic field reads as

$$\begin{aligned} F_{em} &= (3 + 2p) \frac{r}{F^2} dr \wedge (d\Psi + \cos(\Theta)d\Phi) + (3 + p) \frac{r^2}{2F} \sin(\Theta)d\Theta \wedge d\Phi , \\ p &= \sin^2(\Theta_W) , \end{aligned} \tag{A-7.2}$$

where  $\Theta_W$  denotes Weinberg angle.

a) The vanishing of the electromagnetic fields is guaranteed, when the conditions

$$\begin{aligned} \Psi &= k\Phi , \\ (3 + 2p) \frac{1}{r^2 F} (d(r^2)/d\Theta)(k + \cos(\Theta)) + (3 + p) \sin(\Theta) &= 0 , \end{aligned} \tag{A-7.3}$$

hold true. The conditions imply that  $CP_2$  projection of the electromagnetically neutral space-time is 2-dimensional. Solving the differential equation one obtains

$$\begin{aligned} r &= \sqrt{\frac{X}{1-X}} , \\ X &= D \left[ \frac{(k+u)}{C} \right]^\epsilon , \\ u &\equiv \cos(\Theta) , \quad C = k + \cos(\Theta_0) , \quad D = \frac{r_0^2}{1+r_0^2} , \quad \epsilon = \frac{3+p}{3+2p} , \end{aligned} \tag{A-7.4}$$

where  $C$  and  $D$  are integration constants.  $0 \leq X \leq 1$  is required by the reality of  $r$ .  $r = 0$  would correspond to  $X = 0$  giving  $u = -k$  achieved only for  $|k| \leq 1$  and  $r = \infty$  to  $X = 1$  giving  $|u + k| = [(1 + r_0^2)/r_0^2]^{(3+2p)/(3+p)}$  achieved only for

$$\text{sign}(u + k) \times \left[ \frac{1 + r_0^2}{r_0^2} \right]^{\frac{3+2p}{3+p}} \leq k + 1 \ ,$$

where  $\text{sign}(x)$  denotes the sign of  $x$ .

The expressions for Kähler form and  $Z^0$  field are given by

$$\begin{aligned} J &= -\frac{p}{3+2p} X du \wedge d\Phi \ , \\ Z^0 &= -\frac{6}{p} J \ . \end{aligned} \tag{A-7.5}$$

The components of the electromagnetic field generated by varying vacuum parameters are proportional to the components of the Kähler field: in particular, the magnetic field is parallel to the Kähler magnetic field. The generation of a long range  $Z^0$  vacuum field is a purely TGD based feature not encountered in the standard gauge theories.

b) The vanishing of  $Z^0$  fields is achieved by the replacement of the parameter  $\epsilon$  with  $\epsilon = 1/2$  as becomes clear by considering the condition stating that  $Z^0$  field vanishes identically. Also the relationship  $F_{em} = 3J = -\frac{3}{4} \frac{r^2}{F} du \wedge d\Phi$  is useful.

c) The vanishing Kähler field corresponds to  $\epsilon = 1, p = 0$  in the formula for em neutral space-times. In this case classical em and  $Z^0$  fields are proportional to each other:

$$\begin{aligned} Z^0 &= 2e^0 \wedge e^3 = \frac{r}{F^2} (k + u) \frac{\partial r}{\partial u} du \wedge d\Phi = (k + u) du \wedge d\Phi \ , \\ r &= \sqrt{\frac{X}{1-X}} \ , \ X = D|k + u| \ , \\ \gamma &= -\frac{p}{2} Z^0 \ . \end{aligned} \tag{A-7.6}$$

For a vanishing value of Weinberg angle ( $p = 0$ ) em field vanishes and only  $Z^0$  field remains as a long range gauge field. Vacuum extremals for which long range  $Z^0$  field vanishes but em field is non-vanishing are not possible.

**The effective form of  $CP_2$  metric for surfaces with 2-dimensional  $CP_2$  projection**

The effective form of the  $CP_2$  metric for a space-time having vanishing em,  $Z^0$ , or Kähler field is of practical value in the case of vacuum extremals and is given by

$$\begin{aligned} ds_{eff}^2 &= (s_{rr} \left(\frac{dr}{d\Theta}\right)^2 + s_{\Theta\Theta}) d\Theta^2 + (s_{\Phi\Phi} + 2ks_{\Phi\Psi}) d\Phi^2 = \frac{R^2}{4} [s_{\Theta\Theta}^{eff} d\Theta^2 + s_{\Phi\Phi}^{eff} d\Phi^2] \ , \\ s_{\Theta\Theta}^{eff} &= X \times \left[ \frac{\epsilon^2(1-u^2)}{(k+u)^2} \times \frac{1}{1-X} + 1 - X \right] \ , \\ s_{\Phi\Phi}^{eff} &= X \times [(1-X)(k+u)^2 + 1 - u^2] \ , \end{aligned} \tag{A-7.7}$$

and is useful in the construction of vacuum imbedding of, say Schwartzchild metric.

**Topological quantum numbers**

Space-times for which either em,  $Z^0$ , or Kähler field vanishes decompose into regions characterized by six vacuum parameters: two of these quantum numbers ( $\omega_1$  and  $\omega_2$ ) are frequency type parameters, two ( $k_1$  and  $k_2$ ) are wave vector like quantum numbers, two of the quantum numbers ( $n_1$  and  $n_2$ ) are integers. The parameters  $\omega_i$  and  $n_i$  will be referred as electric and magnetic quantum numbers. The existence of these quantum numbers is not a feature of these solutions alone but represents a

much more general phenomenon differentiating in a clear cut manner between TGD and Maxwell's electrodynamics.

The simplest manner to avoid surface Kähler charges and discontinuities or infinities in the derivatives of  $CP_2$  coordinates on the common boundary of two neighboring regions with different vacuum quantum numbers is topological field quantization, 3-space decomposes into disjoint topological field quanta, 3-surfaces having outer boundaries with possibly macroscopic size.

Under rather general conditions the coordinates  $\Psi$  and  $\Phi$  can be written in the form

$$\begin{aligned}\Psi &= \omega_2 m^0 + k_2 m^3 + n_2 \phi + \text{Fourier expansion} , \\ \Phi &= \omega_1 m^0 + k_1 m^3 + n_1 \phi + \text{Fourier expansion} .\end{aligned}\tag{A-7.8}$$

$m^0, m^3$  and  $\phi$  denote the coordinate variables of the cylindrical  $M^4$  coordinates) so that one has  $k = \omega_2/\omega_1 = n_2/n_1 = k_2/k_1$ . The regions of the space-time surface with given values of the vacuum parameters  $\omega_i, k_i$  and  $n_i$  and  $m$  and  $C$  are bounded by the surfaces at which space-time surface becomes ill-defined, say by  $r > 0$  or  $r < \infty$  surfaces.

The space-time surface decomposes into regions characterized by different values of the vacuum parameters  $r_0$  and  $\Theta_0$ . At  $r = \infty$  surfaces  $n_2, \omega_2$  and  $m$  can change since all values of  $\Psi$  correspond to the same point of  $CP_2$ : at  $r = 0$  surfaces also  $n_1$  and  $\omega_1$  can change since all values of  $\Phi$  correspond to same point of  $CP_2$ , too. If  $r = 0$  or  $r = \infty$  is not in the allowed range space-time surface develops a boundary.

This implies what might be called topological quantization since in general it is not possible to find a smooth global imbedding for, say a constant magnetic field. Although global imbedding exists it decomposes into regions with different values of the vacuum parameters and the coordinate  $u$  in general possesses discontinuous derivative at  $r = 0$  and  $r = \infty$  surfaces. A possible manner to avoid edges of space-time is to allow field quantization so that 3-space (and field) decomposes into disjoint quanta, which can be regarded as structurally stable units a 3-space (and of the gauge field). This doesn't exclude partial join along boundaries for neighboring field quanta provided some additional conditions guaranteeing the absence of edges are satisfied.

For instance, the vanishing of the electromagnetic fields implies that the condition

$$\Omega \equiv \frac{\omega_2}{n_2} - \frac{\omega_1}{n_1} = 0 ,\tag{A-7.9}$$

is satisfied. In particular, the ratio  $\omega_2/\omega_1$  is rational number for the electromagnetically neutral regions of space-time surface. The change of the parameter  $n_1$  and  $n_2$  ( $\omega_1$  and  $\omega_2$ ) in general generates magnetic field and therefore these integers will be referred to as magnetic (electric) quantum numbers.

## A-8 p-Adic numbers and TGD

### A-8.1 p-Adic number fields

p-Adic numbers ( $p$  is prime: 2,3,5,...) can be regarded as a completion of the rational numbers using a norm, which is different from the ordinary norm of real numbers [A2] . p-Adic numbers are representable as power expansion of the prime number  $p$  of form:

$$x = \sum_{k \geq k_0} x(k) p^k, \quad x(k) = 0, \dots, p-1 .\tag{A-8.1}$$

The norm of a p-adic number is given by

$$|x| = p^{-k_0(x)} .\tag{A-8.2}$$

Here  $k_0(x)$  is the lowest power in the expansion of the p-adic number. The norm differs drastically from the norm of the ordinary real numbers since it depends on the lowest binary digit of the p-adic

number only. Arbitrarily high powers in the expansion are possible since the norm of the p-adic number is finite also for numbers, which are infinite with respect to the ordinary norm. A convenient representation for p-adic numbers is in the form

$$x = p^{k_0} \varepsilon(x) , \tag{A-8.3}$$

where  $\varepsilon(x) = k + \dots$  with  $0 < k < p$ , is p-adic number with unit norm and analogous to the phase factor  $\exp(i\phi)$  of a complex number.

The distance function  $d(x, y) = |x - y|_p$  defined by the p-adic norm possesses a very general property called ultra-metricity:

$$d(x, z) \leq \max\{d(x, y), d(y, z)\} . \tag{A-8.4}$$

The properties of the distance function make it possible to decompose  $R_p$  into a union of disjoint sets using the criterion that  $x$  and  $y$  belong to same class if the distance between  $x$  and  $y$  satisfies the condition

$$d(x, y) \leq D . \tag{A-8.5}$$

This division of the metric space into classes has following properties:

- a) Distances between the members of two different classes  $X$  and  $Y$  do not depend on the choice of points  $x$  and  $y$  inside classes. One can therefore speak about distance function between classes.
- b) Distances of points  $x$  and  $y$  inside single class are smaller than distances between different classes.
- c) Classes form a hierarchical tree.

Notice that the concept of the ultra-metricity emerged in physics from the models for spin glasses and is believed to have also applications in biology [B4] . The emergence of p-adic topology as the topology of the effective space-time would make ultra-metricity property basic feature of physics.

### A-8.2 Canonical correspondence between p-adic and real numbers

The basic challenge encountered by p-adic physicist is how to map the predictions of the p-adic physics to real numbers. p-Adic probabilities provide a basic example in this respect. Identification via common rationals and canonical identification and its variants have turned out to play a key role in this respect.

#### Basic form of canonical identification

There exists a natural continuous map  $I : R_p \rightarrow R_+$  from p-adic numbers to non-negative real numbers given by the "pinary" expansion of the real number for  $x \in R$  and  $y \in R_p$  this correspondence reads

$$y = \sum_{k > N} y_k p^k \rightarrow x = \sum_{k < N} y_k p^{-k} ,$$

$$y_k \in \{0, 1, \dots, p - 1\} . \tag{A-8.6}$$

This map is continuous as one easily finds out. There is however a little difficulty associated with the definition of the inverse map since the pinary expansion like also decimal expansion is not unique ( $1 = 0.999\dots$ ) for the real numbers  $x$ , which allow pinary expansion with finite number of pinary digits

$$x = \sum_{k=N_0}^N x_k p^{-k} ,$$

$$x = \sum_{k=N_0}^{N-1} x_k p^{-k} + (x_N - 1)p^{-N} + (p - 1)p^{-N-1} \sum_{k=0, \dots} p^{-k} . \tag{A-8.7}$$

The p-adic images associated with these expansions are different

$$\begin{aligned}
 y_1 &= \sum_{k=N_0}^N x_k p^k, \\
 y_2 &= \sum_{k=N_0}^{N-1} x_k p^k + (x_N - 1)p^N + (p - 1)p^{N+1} \sum_{k=0, \dots} p^k \\
 &= y_1 + (x_N - 1)p^N - p^{N+1}, \tag{A-8.8}
 \end{aligned}$$

so that the inverse map is either two-valued for p-adic numbers having expansion with finite pinary digits or single valued and discontinuous and non-surjective if one makes pinary expansion unique by choosing the one with finite pinary digits. The finite pinary digit expansion is a natural choice since in the numerical work one always must use a pinary cutoff on the real axis.

**The topology induced by canonical identification**

The topology induced by the canonical identification in the set of positive real numbers differs from the ordinary topology. The difference is easily understood by interpreting the p-adic norm as a norm in the set of the real numbers. The norm is constant in each interval  $[p^k, p^{k+1})$  (see Fig. A-8.2) and is equal to the usual real norm at the points  $x = p^k$ : the usual linear norm is replaced with a piecewise constant norm. This means that p-adic topology is coarser than the usual real topology and the higher the value of  $p$  is, the coarser the resulting topology is above a given length scale. This hierarchical ordering of the p-adic topologies will be a central feature as far as the proposed applications of the p-adic numbers are considered.

Ordinary continuity implies p-adic continuity since the norm induced from the p-adic topology is rougher than the ordinary norm. p-Adic continuity implies ordinary continuity from right as is clear already from the properties of the p-adic norm (the graph of the norm is indeed continuous from right). This feature is one clear signature of the p-adic topology.

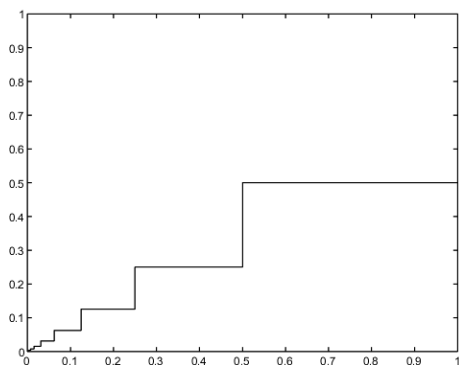

Figure 14: The real norm induced by canonical identification from 2-adic norm.

The linear structure of the p-adic numbers induces a corresponding structure in the set of the non-negative real numbers and p-adic linearity in general differs from the ordinary concept of linearity. For example, p-adic sum is equal to real sum only provided the summands have no common pinary digits. Furthermore, the condition  $x +_p y < \max\{x, y\}$  holds in general for the p-adic sum of the real numbers. p-Adic multiplication is equivalent with the ordinary multiplication only provided that either of the members of the product is power of  $p$ . Moreover one has  $x \times_p y < x \times y$  in general. The p-Adic negative  $-1_p$  associated with p-adic unit 1 is given by  $(-1)_p = \sum_k (p - 1)p^k$  and defines p-adic negative for each real number  $x$ . An interesting possibility is that p-adic linearity might replace the

ordinary linearity in some strongly nonlinear systems so these systems would look simple in the p-adic topology.

These results suggest that canonical identification is involved with some deeper mathematical structure. The following inequalities hold true:

$$\begin{aligned} (x + y)_R &\leq x_R + y_R \ , \\ |x|_p |y|_R &\leq (xy)_R \leq x_R y_R \ , \end{aligned} \tag{A-8.9}$$

where  $|x|_p$  denotes p-adic norm. These inequalities can be generalized to the case of  $(R_p)^n$  (a linear vector space over the p-adic numbers).

$$\begin{aligned} (x + y)_R &\leq x_R + y_R \ , \\ |\lambda|_p |y|_R &\leq (\lambda y)_R \leq \lambda_R y_R \ , \end{aligned} \tag{A-8.10}$$

where the norm of the vector  $x \in T_p^n$  is defined in some manner. The case of Euclidian space suggests the definition

$$(x_R)^2 = \left( \sum_n x_n^2 \right)_R \ . \tag{A-8.11}$$

These inequalities resemble those satisfied by the vector norm. The only difference is the failure of linearity in the sense that the norm of a scaled vector is not obtained by scaling the norm of the original vector. Ordinary situation prevails only if the scaling corresponds to a power of  $p$ .

These observations suggests that the concept of a normed space or Banach space might have a generalization and physically the generalization might apply to the description of some non-linear systems. The nonlinearity would be concentrated in the nonlinear behavior of the norm under scaling.

**Modified form of the canonical identification**

The original form of the canonical identification is continuous but does not respect symmetries even approximately. This led to a search of variants which would do better in this respect. The modification of the canonical identification applying to rationals only and given by

$$I_Q(q = p^k \times \frac{r}{s}) = p^k \times \frac{I(r)}{I(s)} \tag{A-8.12}$$

is uniquely defined for rationals, maps rationals to rationals, has also a symmetry under exchange of target and domain. This map reduces to a direct identification of rationals for  $0 \leq r < p$  and  $0 \leq s < p$ . It has turned out that it is this map which most naturally appears in the applications. The map is obviously continuous locally since p-adically small modifications of  $r$  and  $s$  mean small modifications of the real counterparts.

Canonical identification is in a key role in the successful predictions of the elementary particle masses. The predictions for the light elementary particle masses are within extreme accuracy same for  $I$  and  $I_Q$  but  $I_Q$  is theoretically preferred since the real probabilities obtained from p-adic ones by  $I_Q$  sum up to one in p-adic thermodynamics.

**Generalization of number concept and notion of imbedding space**

TGD forces an extension of number concept: roughly a fusion of reals and various p-adic number fields along common rationals is in question. This induces a similar fusion of real and p-adic imbedding spaces. Since finite p-adic numbers correspond always to non-negative reals  $n$ -dimensional space  $R^n$  must be covered by  $2^n$  copies of the p-adic variant  $R_p^n$  of  $R^n$  each of which projects to a copy of  $R_+^n$  (four quadrants in the case of plane). The common points of p-adic and real imbedding spaces are rational points and most p-adic points are at real infinity.

For a given p-adic space-time sheet most points are literally infinite as real points and the projection to the real imbedding space consists of a discrete set of rational points: the interpretation in terms of the unavoidable discreteness of the physical representations of cognition is natural. Purely local p-adic physics implies real p-adic fractality and thus long range correlations for the real space-time surfaces having enough common points with this projection.

p-Adic fractality means that  $M^4$  projections for the rational points of space-time surface  $X^4$  are related by a direct identification whereas  $CP_2$  coordinates of  $X^4$  at these points are related by  $I, I_Q$  or some of its variants implying long range correlates for  $CP_2$  coordinates. Since only a discrete set of points are related in this manner, both real and p-adic field equations can be satisfied and there are no problems with symmetries. p-Adic effective topology is expected to be a good approximation only within some length scale range which means infrared and UV cutoffs. Also multi-p-fractality is possible.



# Mathematics

- [A1] Gaussian Mersenne. <http://primes.utm.edu/glossary/xpage/GaussianMersenne.html>.
- [A2] Z. I. Borevich and I. R. Shafarevich. *Number Theory*. Academic Press, 1966.
- [A3] Eisenhart. *Riemannian Geometry*. Princeton University Press, 1964.
- [A4] C. N. Pope G. W. Gibbons.  $CP_2$  as gravitational instanton. *Comm. Math. Phys.*, 55, 1977.
- [A5] W. Hawking, S. and N. Pope, C. Generalized Spin Structures in Quantum Gravity. *Phys. Lett.*, (1), 1978.
- [A6] S. Helgason. *Differential Geometry and Symmetric Spaces*. Academic Press, New York, 1962.
- [A7] C. Itzykson and J-B. Zuber. *Quantum Field Theory*, volume 549. Mc Graw-Hill, New York, 1980.
- [A8] J. Milnor. *Topology form Differential Point of View*. The University Press of Virginia, Virginia, 1965.
- [A9] D. S. Moak. The q-analogue of the Laguerre polynomials. *J. Math. Anal. Appl.*, 81, 1981.
- [A10] N. Pope, C. Eigenfunctions and  $Spin^c$  Structures on  $CP_2$ , 1980.
- [A11] B. Shipman. The geometry of momentum mappings on generalized flag manifolds, connections with a dynamical system, quantum mechanics and the dance of honeybee. <http://math.cornell.edu/~oliver/Shipman.gif>, 1998.
- [A12] M. Spivak. *Differential Geometry I,II,III,IV*. Publish or Perish, Boston, 1970.
- [A13] J. Hanson T. Eguchi, B. Gilkey. *Phys. Rep.*, 66:1980, 1980.
- [A14] R. Thom. *Commentarii Math. Helvet.*, 28, 1954.
- [A15] Wallace. *Differential Topology*. W. A. Benjamin, New York, 1968.
- [A16] E. C. Zeeman. *Catastrophe Theory*. Addison-Wessley Publishing Company, 1977.



# Theoretical Physics

- [B1] J. Björken and S. Drell. *Relativistic Quantum Fields*. Mc Graw-Hill, New York, 1965.
- [B2] K. Huang. *Quarks, Leptons & Gauge Fields*. World Scientific, 1982.
- [B3] R. Kiehn. Electromagnetic waves in vacuum with torsion and spin. <http://www22.pair.com/csdc/pdf/helical6.pdf>.
- [B4] G. Parisi. *Field Theory, Disorder and Simulations*. World Scientific, 1992.
- [B5] A. Zee. *The Unity of Forces in the Universe*. World Science Press, Singapore, 1982.



# Index

- H*-chirality, 1190
- $M^8 - H$  duality, 52
- $N = 4$  SCA, 421
- $N = 4$  super-conformal symmetry, 342, 344
- $\mathcal{N} = 4$  SYM, 659
- 'holy trinity' of time developments, 409
- , 1186
- absolute minimization of Kähler action, 85
- adjoint functor, 1157
- Alfven wave, 73
- algebra module, 1145, 1146
- algebraic genus, 682
- algebraic quantum field theory, 477, 938
- anti-commutativity, 562
- antichiral super-field, 812
- anticipation, 554
- antipode, 1151
- associative sub-algebra, 288
- Barbara Shipman, 406
- BCFW bridge, 670
- BCFW recursion formula, 659, 665
- Beltrami conditions, 50
- Beltrami fields, 19
- Bethe-Salpeter equations, 948
- Betti number, 1186
- bi-algebra, 938, 1149
- bi-commutant, 941
- bi-locality, 850, 851
- Bott periodicity, 810, 961
- braid group, 938
- braid group representations, 507, 562, 1165
- braided bi-algebra, 1153
- braided Hopf algebra, 1154, 1163
- braided tensor category, 1156, 1160, 1162
- c*, 1185
- Calabi-Yau manifold, 682
- canonical unitary evolution, 942
- Cartan decomposition, 291
- Cartan matrix, 1174
- Cayley-Dickson construction, 964
- central extension, 293
- chiral selection, 806, 813
- chiral super-field, 805
- Christoffel symbol, 67
- classical TGD, 18
- CMB background, 1146
- co-algebra, 1147
- co-associative, 1146
- co-associativity, 600, 601, 1145
- co-hyper-quaternionic, 965
- co-hyper-quaternionic surface, 18
- co-hyper-quaternionic surfaces, 591, 963, 1146, 1152
- co-hyper-quaternionicity, 52
- co-module, 1145
- co-operativity, 1145
- co-unit, 1145
- coherence lengths, 411, 807
- coherence region, 411
- coherent states of photons, 58
- Combinatorial Hierarchy, 472
- complexified octonions, 349
- complexified quaternions, 962
- Configuration space gamma matrices, 960
- configuration space Hamiltonian, 76
- configuration space Hamiltonians, 960
- configuration space spinor structure, 60
- conformal structure, 61
- conformally compactified Minkowski space, 662
- Connes, 475, 943
- Connes spectrum, 474
- contact form, 64
- contact structure, 64
- contravariant configuration space metric as propagator, 328
- contravariant metric, 60
- coordinate charts, 1185
- coordinates of Eguchi and Freund, 1185
- cosmic strings, 89
- covariantly constant, 1187
- Coxeter number, 476, 951, 977
- critical dilution factor, 348
- crop formations, 478, 480
- crossed product, 475
- Cutkosky rules, 484, 594, 678
- cytoskeleton, 1083
- delta function, 938
- divergence cancellation, 18
- Drinfeld's associator, 1155
- Drinfeld's quantum double, 1146, 1154
- dual super-conformal symmetries, 662
- dyons, 839, 840

- effective 2-dimensionality, 683  
 Eguchi-Hanson coordinates, 498  
 electric-magnetic duality, 840  
 electro-weak couplings, 1189  
 electro-weak interactions, 1189  
 ergodic flow, 475  
 Euler equations, 63  
 extended Dynkin graph, 476, 951, 977  
  
 factors of type III, 398  
 fermionic oscillator algebra, 396, 811, 832, 1044  
 fermionic propagator, 64  
 Feynman diagrams as higher level particles, 511, 1005  
 Feynman graph, 938  
 field-particle duality, 289  
 four-color problem, 950  
 fractal cosmology, 94  
 Freudenthal triple system, 349  
 functor, 1157  
 fusion coefficients, 430  
 fuzzy quantum mechanics, 940  
  
 generalized Beltrami conditions, 19  
 generalized conformal invariance, 557  
 generalized Feynman diagrammatics, 399, 554  
 generalized Feynman diagrams, 673  
 Geodesic sub-manifolds, 1189  
 Grassmannian integrals, 666  
  
 Haag-Kastler net, 954  
 hadronization, 513, 1007  
 Hamilton Jacobi function, 92  
 Hamilton-Jacobi structure, 65  
 Hermitian conjugation, 937  
 hierarchy of generalized Feynman diagrams, 511, 966, 1005  
 Hodge numbers, 682  
 holonomy, 1193  
 homotopy group, 1188  
 Hopf algebra, 938, 1151  
 hyper-complex primes, 676  
 hyper-finite  $II_1$ , 941  
 hyper-finite factor of type  $II_1$ , 839, 941  
 hyper-finite factors of type  $II_1$ , 937  
 hyper-multiplet, 834  
 hyper-quaternionic, 965  
 hyper-quaternionic surface, 18  
 hyper-quaternionic surfaces, 963  
  
 induced spinor connection, 1189  
 Infinite primes, 965  
 infinite-dimensional symmetric space with Kähler structure, 288  
 infinity twistor, 663  
 informational time development—hyperpage, 409  
 instanton current, 19  
 inverse soft factors, 668  
  
 ionic pumps, 1080  
 IR regularization, 665  
  
 Jones index, 943  
 Josephson radiation, 1079  
  
 Kähler action, 679  
 Kähler calibration, 89  
 Kähler coupling strength as analog of critical temperature, 18  
 Kähler current, 19  
 Kähler form, 1187  
 Kähler function, 288, 1186  
 Kähler metric, 53, 1186  
 Kähler potential, 1187  
  
 Lie super-algebra, 661  
 Lie triple system, 1189  
 line element, 1186  
 Lobatchevski space, 290  
 local light cone coordinates, 66, 91  
  
 magnetic body as an intentional agent, 1080  
 magnetic monopole, 1187  
 magnetohydrodynamics, 63  
 Majorana, 296  
 Majorana spinors, 349, 816  
 Malcev algebra, 963  
 massless extremals, 89  
 MHV amplitudes, 659  
 minimal projectors, 472  
 minimal SCA, 342  
 module, 1145  
 momentum twistor, 664  
 monodromies, 508, 1155  
 morphic field, 600  
 morphism, 1157  
 MSSM, 819  
  
 negative energy states, 512, 1006  
 non-commutative measure theory, 473, 474  
 non-perturbative phase, 814  
 non-renormalization theorems, 841  
 non-vacuum extremals, 89  
 norm topology, 472  
 normal bi-module, 943  
 null norm states, 420  
 number theoretic compactification, 50  
  
 observable, 937  
 octonion automorphisms, 288  
 octonionic Clifford algebra, 938  
 Olive-Goddard-Kent coset construction, 293  
  
 parallel transport, 1188  
 partonic 2-surfaces, 673  
 partonic Feynman diagrams, 513, 1007  
 path integral, 938

- perceptive field, 554  
 Poincare energy, 95  
 Pontryagin number, 1186  
 prepotential, 838  
 presheaf, 1158  
 pseudo-momentum, 676  
  
 quantum classical correspondence, 19  
 quantum coherence region, 1041  
 quantum gravitational holography, 53  
 quantum holography, 90  
 quantum measurement theory with finite measurement resolution, 490  
  
 R-symmetry, 811, 814, 838  
 region momentum, 664, 676  
 Reissner-Nordström, 95  
 Renormalization group invariance, 18  
 renormalization group invariance, 53  
 ribbon algebra, 938, 1167  
 ribbon category, 1146, 1162, 1163  
 Ricci flatness, 338  
 Riemann structure, 64  
  
 SCA, 342  
 scaled up Compton length, 1042  
 Schwarzschild metric, 102  
 second fundamental form, 59  
 Serre relations, 660  
 sheaf, 1158  
 Sine-Gordon equation, 1083  
 space-time surface as generalized Bohr orbit, 18  
 spin glass analogy, 18, 51  
 spinor connection, 1190  
 spinor structure, 1188  
 Sugawara construction, 294, 351  
 super-conformal Yangian symmetries, 661  
 super-covariant derivatives, 812, 814, 829  
 super-potential, 806, 808  
 super-space, 295, 807  
 Super-symplectic algebra, 960  
 super-Yangian, 661  
 SUSY algebra, 730, 806  
 SUSY breaking, 833, 838  
 SUSY QFT, 805, 806, 815  
 symplectic central extension, 960  
 symplectic fusion algebra, 567  
 symplectic structure, 1187  
 symplectic transformations, 290  
  
 target space, 103, 345, 348  
 Temperley-Lieb algebra, 952  
 tensor category, 1155, 1156, 1160  
 the complex projective space, 1185  
 theta parameter, 805, 807  
 Tomita-Takesaki theorem, 399, 479  
 Tomita-Takesaki theory, 473, 474  
 topological light rays, 89  
  
 trace of the second fundamental form, 59  
 tracial state, 473  
 twistor, 662  
 twistor space, 679  
 twistor string theory, 659  
 twistorialization, 592, 593  
 two-cocycle, 1175  
  
 unwinding, 65  
  
 vacuum extremals, 84  
 vacuum functional as exponent of Kähler function, 18  
 vanishing of Lorentz-Kähler 4-force, 19  
 Vaughan Jones, 945  
 Verma module, 1168  
 vertebrate, 500  
 vertex operator, 348  
 vielbein group, 1190  
 vierbein, 1186  
 vierbein connection, 1187  
 Virasoro conditions, 85  
 volitional act, 404, 407  
 von Neumann algebra, 940  
 vorticity, 65  
  
 wavefunction renormalization, 815  
 Weinberg angle, 1191  
 WZW model, 343  
  
 Yang-Baxter algebra, 952  
 Yangian algebra, 660  
 Yangian invariant, 665  
 Yangian symmetry, 660  
  
 Zamolodchikov algebra, 502  
 zitterbewegung, 85, 95